

Complementary output driver with Hall sensor

Features

- High sensitivity Hall-effect sensor
- Low power consumption
- Output clamping totem-pole drivers
- Lock-shutdown protection & auto-restart function
- Edge detector and propagation delay timer
- Thermal shutdown protection(TSD)
- Available in SIP-4L package
- For 12V to 48V DC motor / FAN systems

Halogen Free

General Description

FD170H is a complementary dual pre-drivers output with embedded Hall-effect sensor IC. It integrates a output clamping totem-pole drivers for NPN or NMOS drivers, a high sensitivity hall-effect sensor, an event timer for rotor locked in SIP-4L package, which make this solution operation under a high power conditions of DC motors or FANS as simply as possible.

For safety, Lock-shutdown function would turn the IC's internal drivers off avoiding over-heat when the rotor is locked, and IC will try to re-start the rotor's torque after the time of these drivers' shutdown.

Thermal-shutdown protection (TSD) ensures the internal drivers of IC are operating under a safe operating temperature range.

All the protection mechanisms mentioned above combine to provide a complete protecting scenario in the motor system and avoid any possible damages and guarantee under a correct and safe operation.

Block Diagram

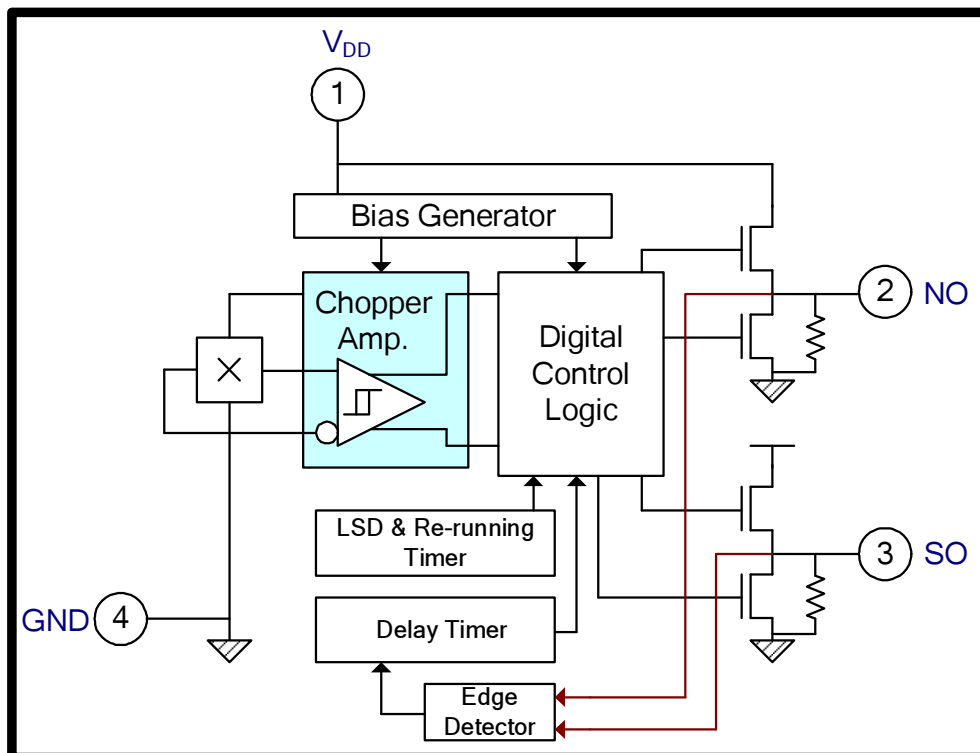
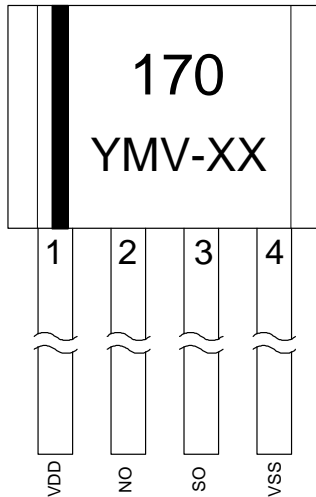
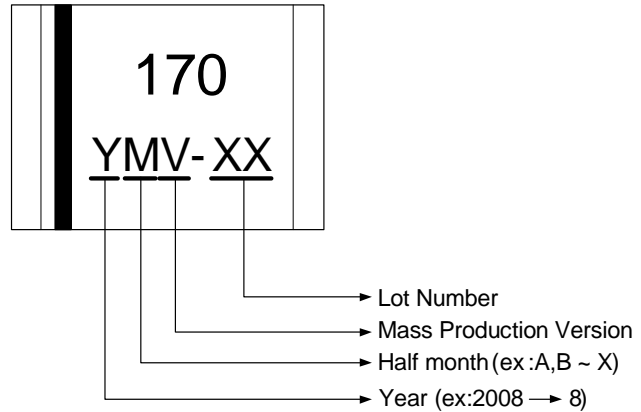

Figure.1

Pin Connection

Figure.2
Marking Distinguish

Figure.3
Pin Descriptions

Name	I/O	FD170H	Description
VDD	P	1	Positive Power Supply
NO	O	2	Driver Output 1
SO	O	3	Driver Output 2
VSS	G	4	Ground

Legend: I=input, O=output, I/O=input/output, P=power supply, G=ground

Functional Descriptions

Refer to the block diagram (Figure.1), FD170H is composed of the following building blocks:

- Bias generator

The bias generator provides precise, temperature- and process-insensitive bias references for the analog blocks. These references guarantee proper operation of the IC under all conditions specified in this specification.

- Timers

The timers provide the lock shutdown and re-start time and propagation delay time counting.

- Output drivers

The output drivers include totem-pole MOS transistors and output voltage clamping functions.

- Chopper Amplifier

To achieve a higher magnetic sensitivity the chopper amplifier structure is adopted in this design. Use of this structure dynamically removes both the offset and flicker noise at the same time.

- Digital Control Logic

- Hall sensor part – generates magnetic pole signals from the Hall-effect sensor.
- Driver part – generates switching signals to the output drivers.
- Detector part – detects the output transient status.

Absolute Maximum Ratings

Parameter	Symbol	Conditions	Values			Unit
			min.	typ.	max.	
Operating Temperature	T _{OP}	-	-40		105	°C
Storage Temperature	T _{ST}	-	-55		150	°C
DC Supply Voltage	V _{DD}	-			29	V
Output Voltage (NO, SO)	V _{OUT}	-			V _{DD} +0.3V	V
Supply Current	I _{DD}	-			2	mA
Continuous Current	I _{O(CONT)}				±20	mA
Hold Current	I _{O(HOLD)}				±50	mA
Peak Current	I _{O(PEAK)}	<100µs			±150	mA
Junction Temperature	T _J				170	°C
Power Dissipation	P _D	SIP-4L			500	mW
Thermal Resistance	θ _{JC}	SIP-4L		100		°C/W
Thermal Resistance	θ _{JA}	SIP-4L		250		°C/W
Magnetic Flux Density	B				Unlimited	Gauss
IR-Reflow Lead Temperature	T _P	10sec			260	°C

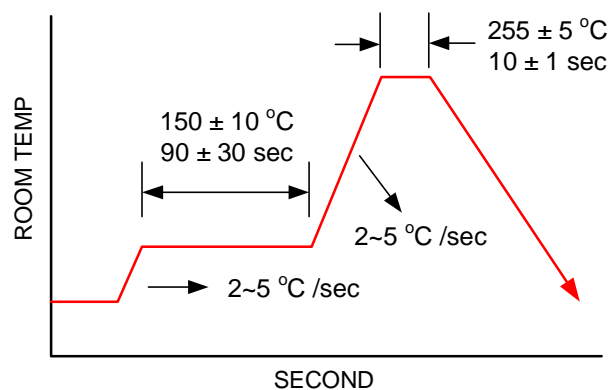
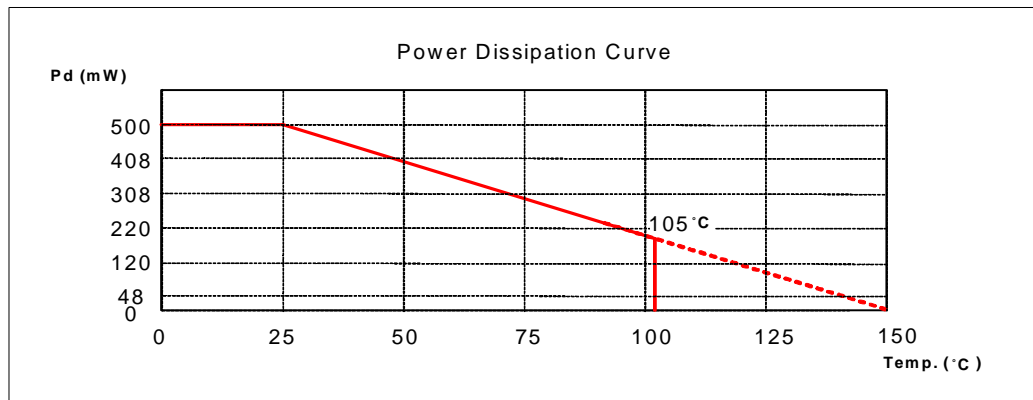

Recommended Operating Conditions

Parameter	Symbol	Conditions	Values			Unit
			min.	typ.	max.	
Supply Voltage	V_{DD}	-	4.0		28	V
Operating Temperature Range	T_a	-	-40		105	°C

Electrical Characteristics $T_a=25^\circ\text{C}$ (unless otherwise specified)

Parameter	Symbol	Conditions	Values			Unit
			min.	typ.	max.	
Average Supply Current(no load)	I_{DD}	$V_{DD} = 24\text{V}$		1.0		mA
On resistance	$R_{DS(ON)}$	$V_{DD} = 5\text{V}$		800		Ω
		$V_{DD} = 24\text{V}$		500		
Thermal Shutdown Threshold	T_{SHUT}		150			°C
Locked Rotor Period	T_{ON}			0.4		s
Locked Rotor Period	T_{OFF}			4.0		s
Propagation Delay Time	T_{PD}			10		μs

Magnetic Characteristics

Parameter	Symbol	Conditions	Values			Unit
			min.	typ.	max.	
Operate Points	B_{OP}		5	25	50	G
Release Points	B_{RP}		-5	-25	-50	G
Hysteresis	B_{HYS}			50		G

Driver output vs. Magnetic Pole

Parameter	Test Conditions	NO	SO
North pole	$B < B_{rp}$	High	Low
South pole	$B > B_{op}$	Low	High

Note: The magnetic pole is applied facing the branded side of the package

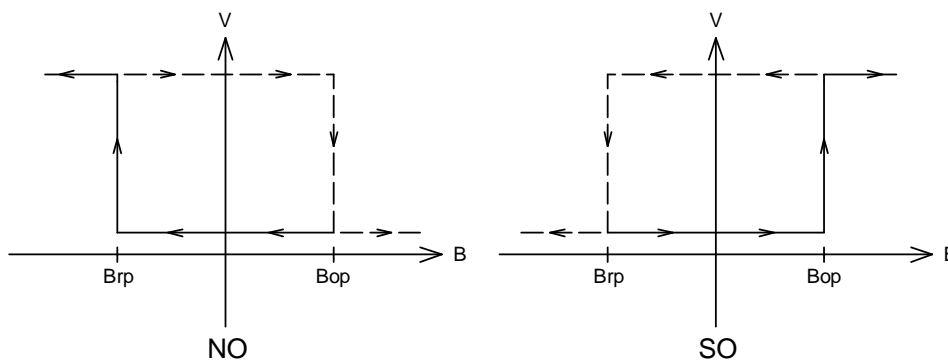
Hysteresis Characteristics

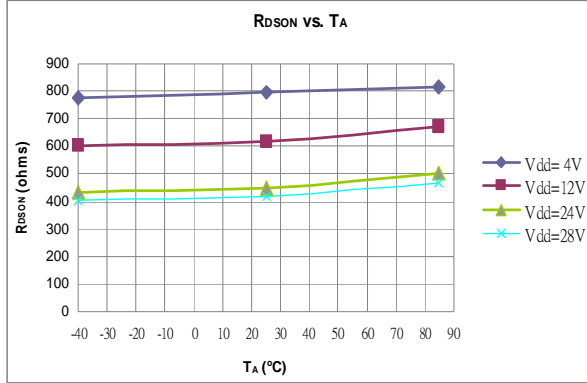
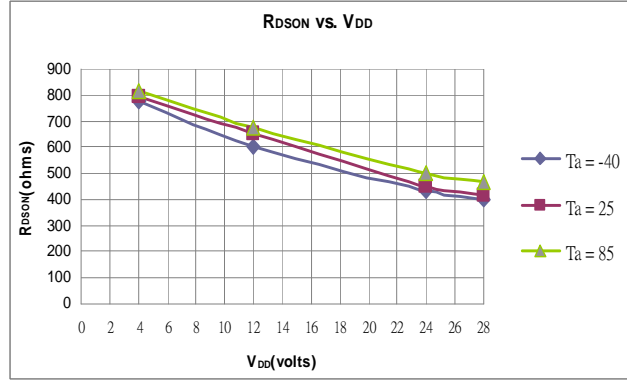
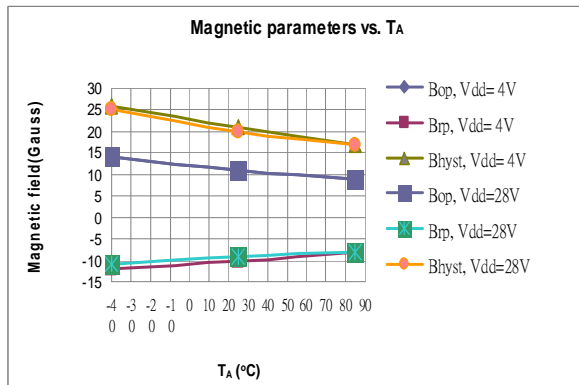
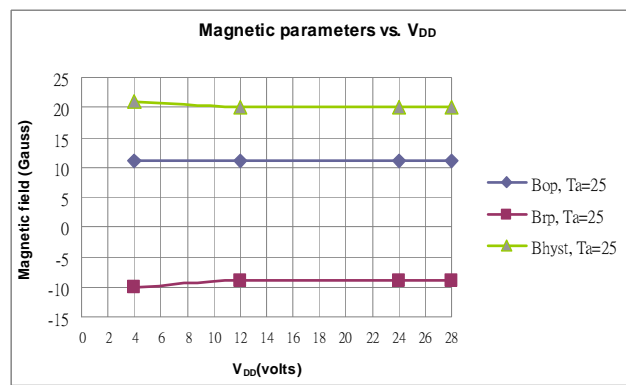
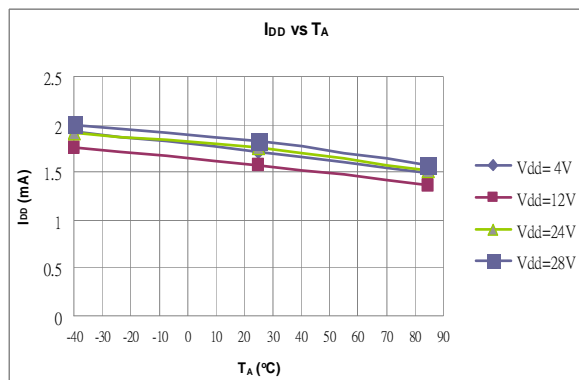
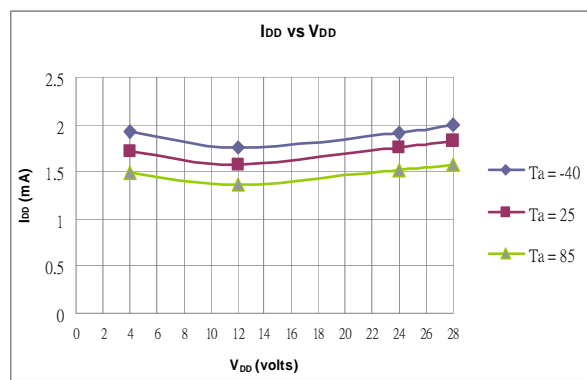
Performance Graphs

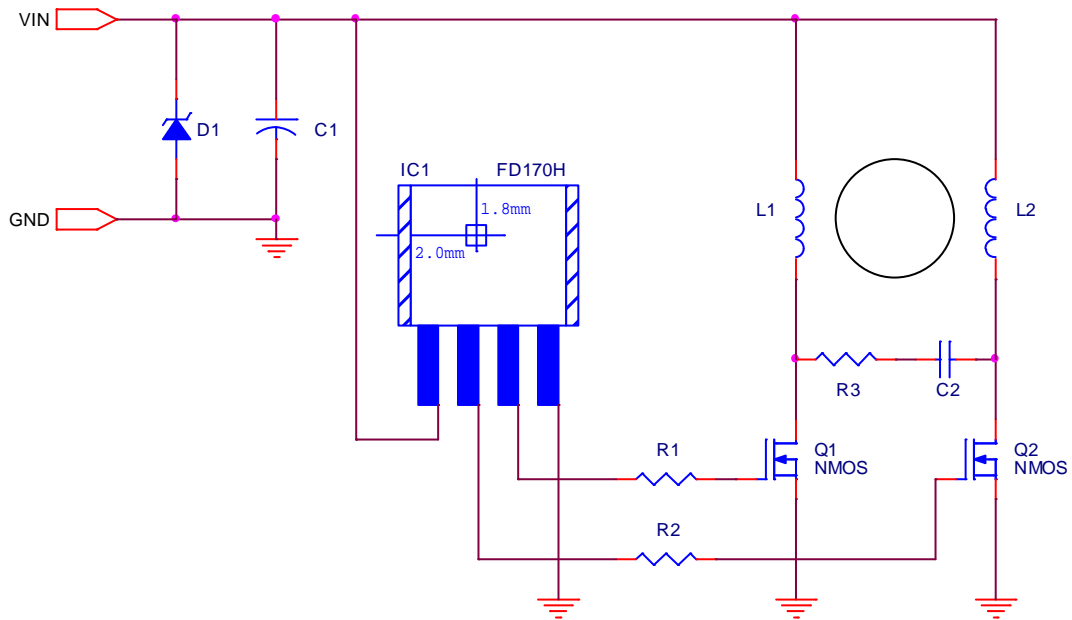
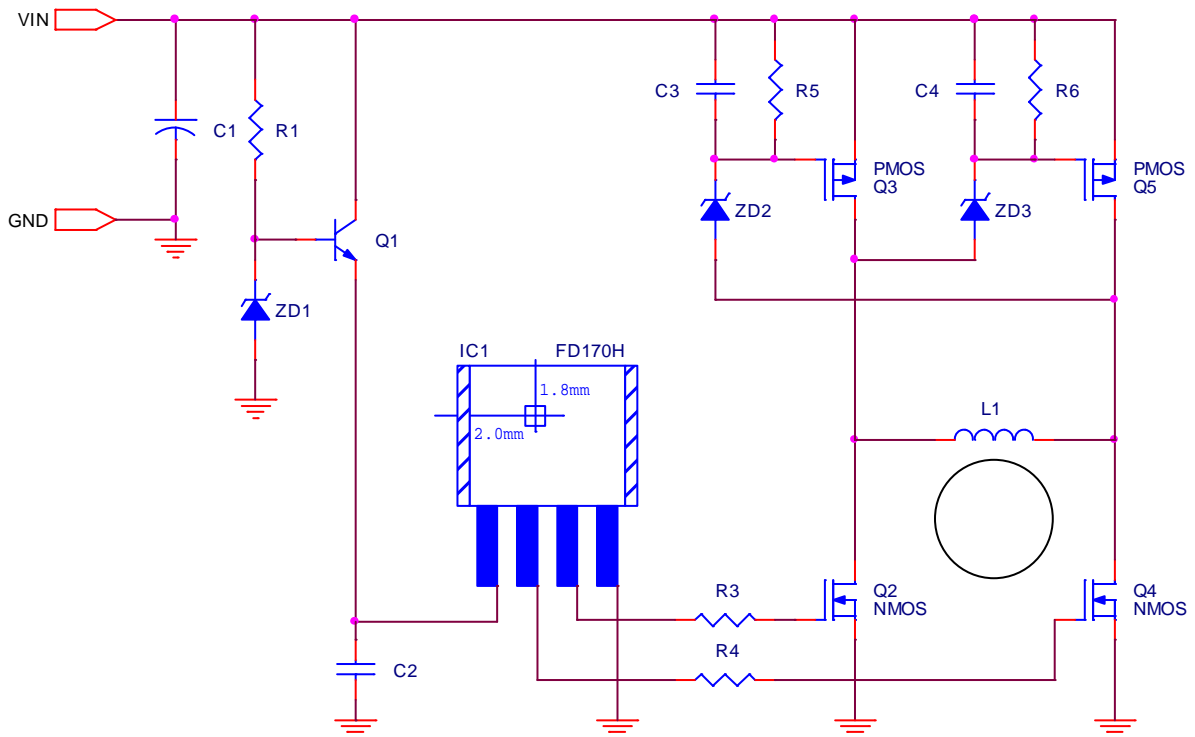
Figure.4

Figure.5

Figure.6

Figure.7

Figure.8

Figure.9

Application Circuit Reference

Figure.10 FD170H Typical Application Circuits (Two-Phase)

Figure.11 FD170H Typical Application Circuits (High Voltage Single-Phase)

FD170H Output Waveforms Description

Figure.12

FD170H Output Waveforms Measurement

Figure.13

Figure.14

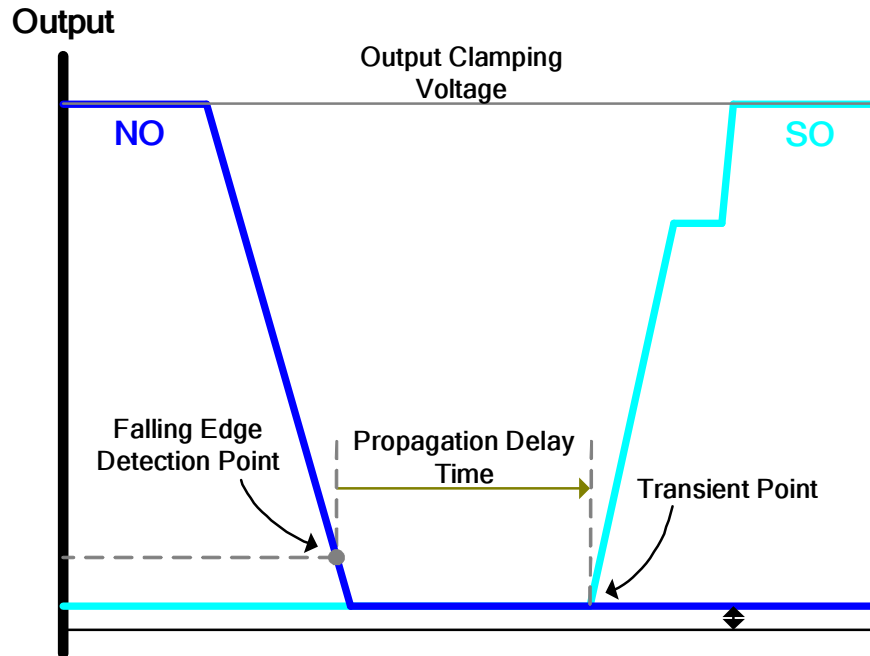
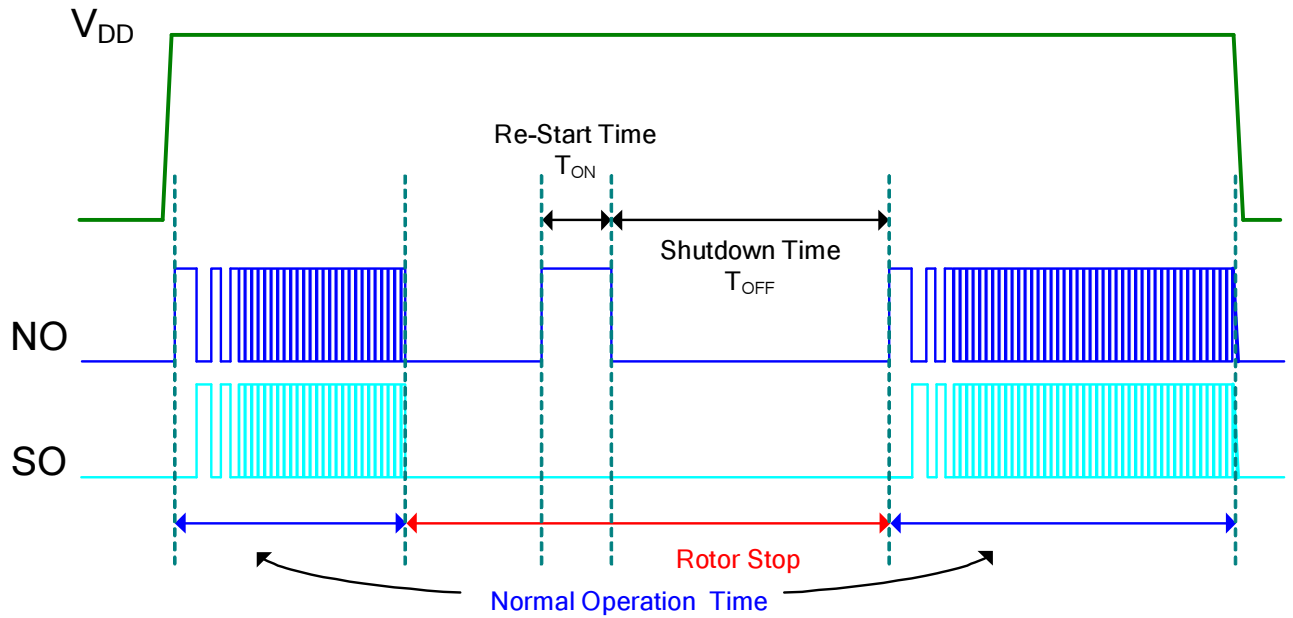
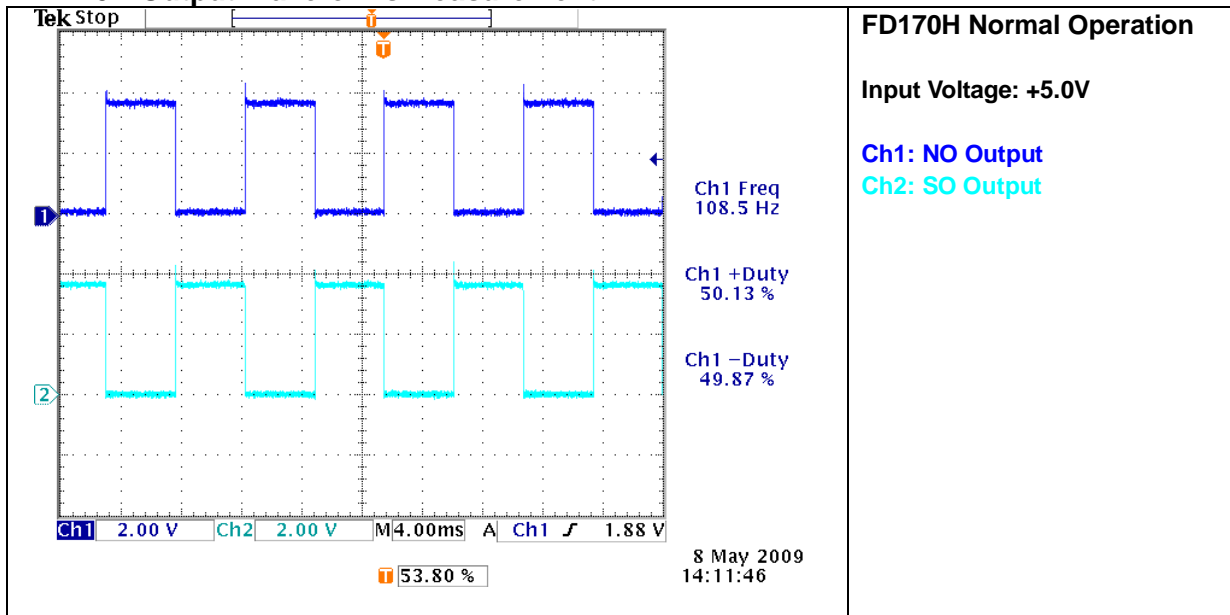
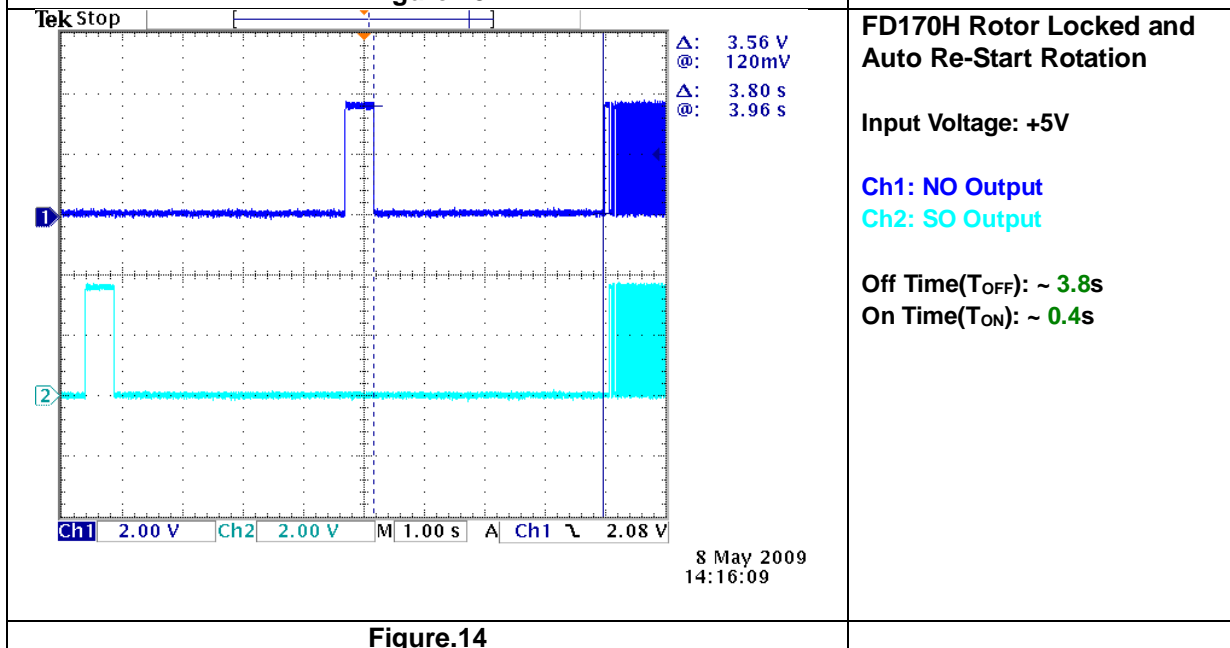
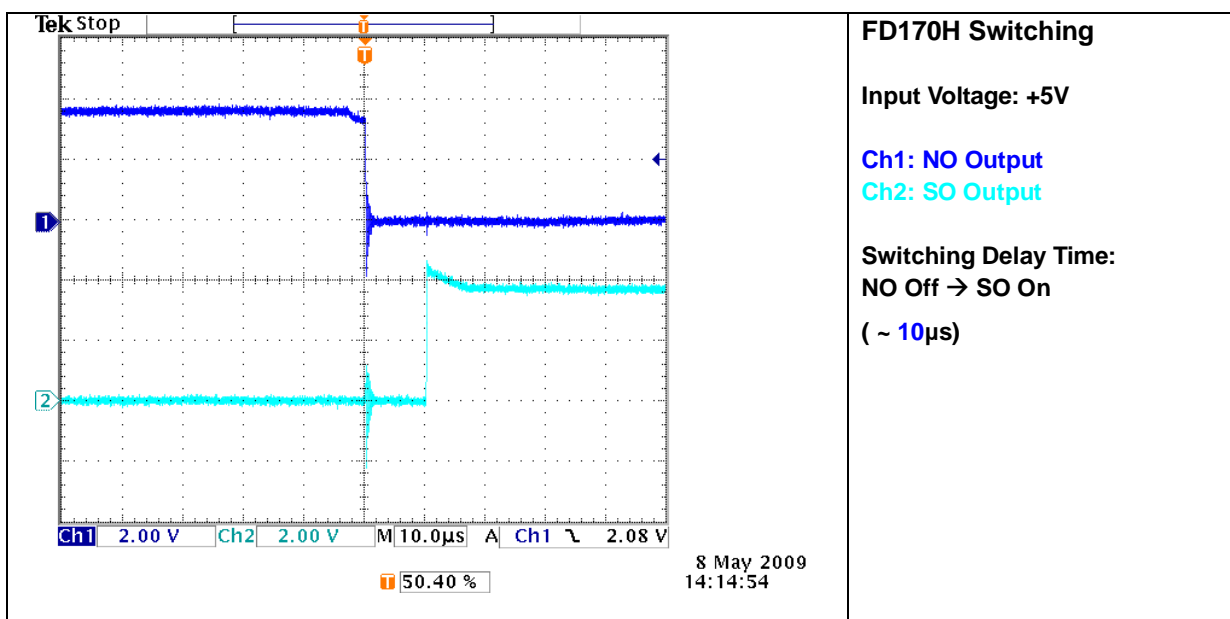

Figure.15

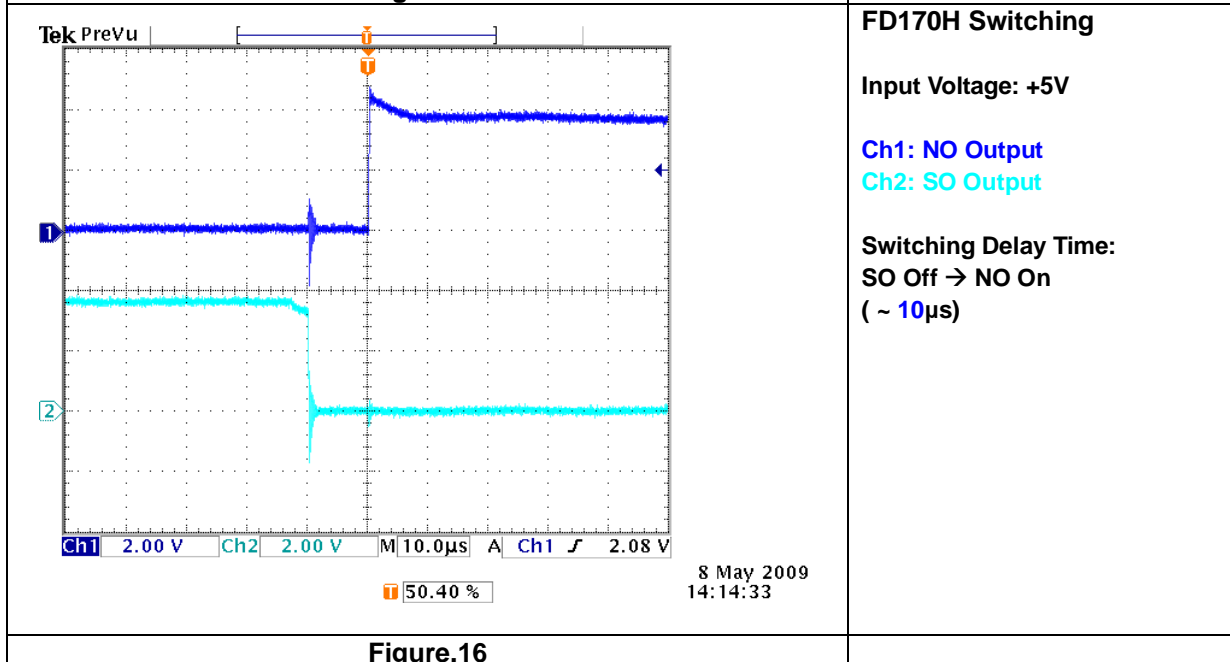
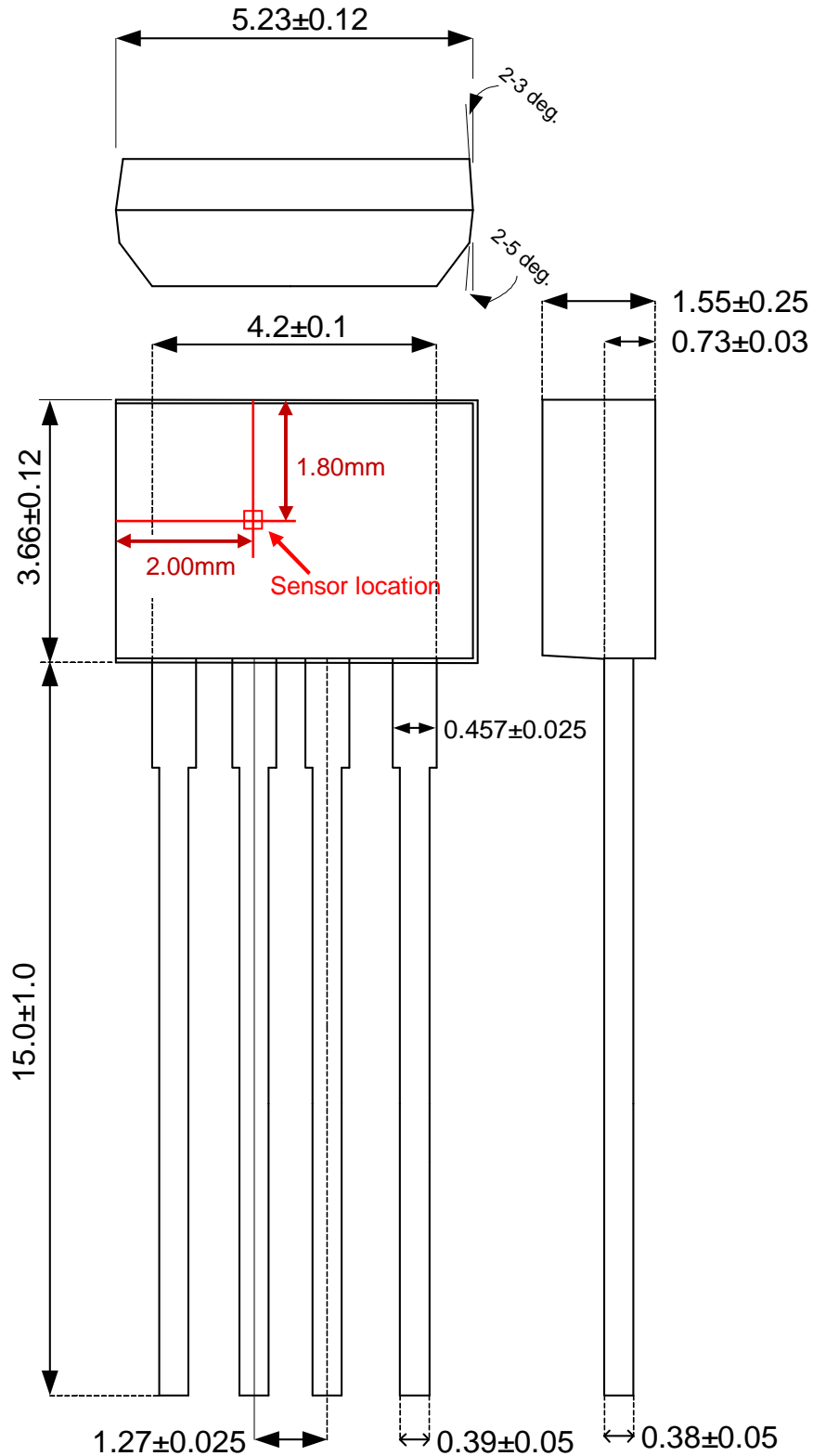
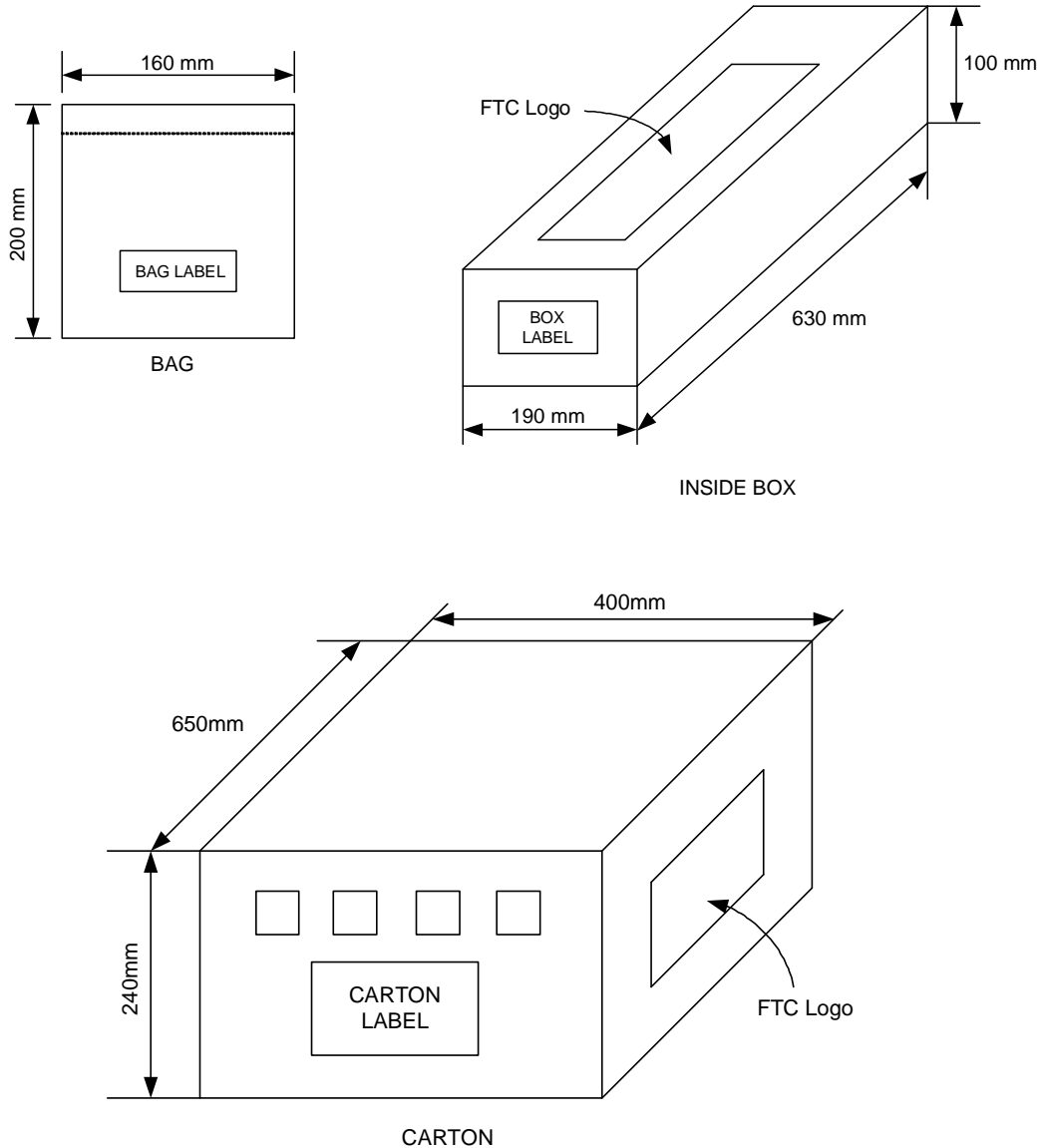

Figure.16



Package Dimension (Unit: mm)
SIP-4L(Halogen Free)



Packing Specification
BAG & BOX DIMANSION

Packing Quantity Specifications

1000 EA / 1 BAG

20 BAGS / 1 INSIDE BOX

4 INSIDE BOXES / 1 CARTON

Order Information

Part Number	Operating Temperature	Package	Description	MOQ	MSL
FD170H-G1	-40 °C to +105 °C	SIP-4L	±50G (B)	1,000 EA / BAG	3