

N-channel 650 V, 0.6 Ω typ., 7 A MDmesh II Plus™ low Q_g
Power MOSFETs in DPAK, TO-220 and IPAK packages

Datasheet - preliminary data

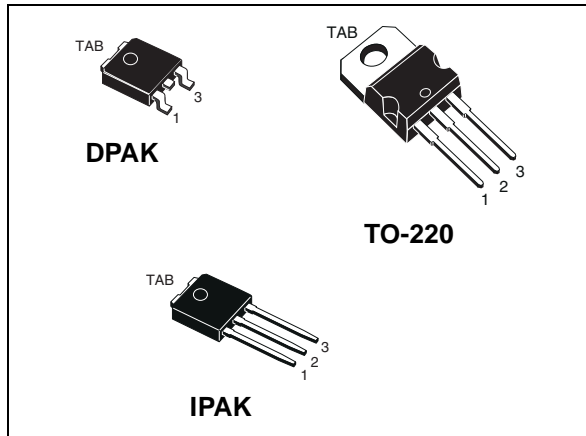
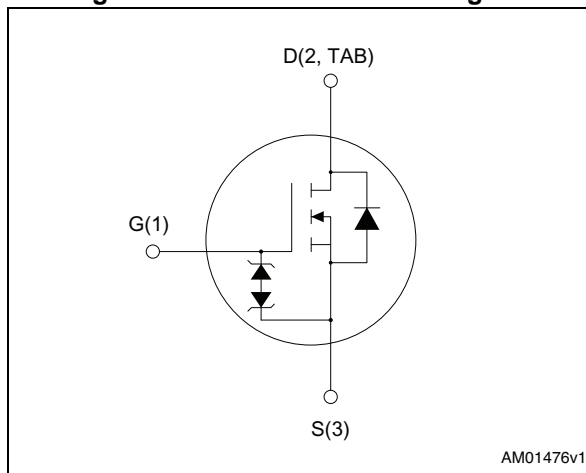

Figure 1. Internal schematic diagram



Features

Order codes	V_{DS}	$R_{DS(on) \max}$	I_D
STD11N65M2	650 V	0.67 Ω	7 A
STP11N65M2			
STU11N65M2			

- Extremely low gate charge
- Lower $R_{DS(on)}$ x area vs previous generation
- Low gate input resistance
- 100% avalanche tested
- Zener-protected

Applications

- Switching applications

Description

These devices are N-channel Power MOSFETs developed using a new generation of MDmesh™ technology: MDmesh II Plus™ low Q_g . These revolutionary Power MOSFETs associate a vertical structure to the company's strip layout to yield one of the world's lowest on-resistance and gate charge. They are therefore suitable for the most demanding high efficiency converters.

Table 1. Device summary

Order codes	Marking	Package	Packaging
STD11N65M2	11N65M2	DPAK	Tape and reel
STP11N65M2		TO-220	Tube
STU11N65M2		IPAK	

Contents

1	Electrical ratings	3
2	Electrical characteristics	4
2.1	Electrical characteristics (curves)	6
3	Test circuits	9
4	Package mechanical data	10
4.1	DPAK, STD11N65M2	11
4.2	TO-220, STP11N65M2	14
4.3	IPAK, STU11N65M2	16
5	Packaging mechanical data	18
6	Revision history	20

1 Electrical ratings

Table 2. Absolute maximum ratings

Symbol	Parameter	Value	Unit
V_{GS}	Gate-source voltage	± 25	V
$I_D^{(1)}$	Drain current (continuous) at $T_C = 25\text{ }^\circ\text{C}$	7	A
$I_D^{(1)}$	Drain current (continuous) at $T_C = 100\text{ }^\circ\text{C}$	4.4	A
$I_{DM}^{(2)}$	Drain current (pulsed)	28	A
$P_{TOT}^{(1)}$	Total dissipation at $T_C = 25\text{ }^\circ\text{C}$	85	W
$dv/dt^{(3)}$	Peak diode recovery voltage slope (starting $T_j = 25\text{ }^\circ\text{C}$, $I_D = I_{AS}$, $V_{DD} = 50\text{ V}$)	15	V/ns
$dv/dt^{(4)}$	MOSFET dv/dt ruggedness	50	V/ns
V_{ISO}	Insulation withstand voltage (RMS) from all three leads to external heat sink ($t = 1\text{ s}$; $T_C = 25\text{ }^\circ\text{C}$)	2500	V
T_{stg}	Storage temperature	- 55 to 150	°C
T_j	Max. operating junction temperature	150	

1. The value is rated according to $R_{thj-case}$ and limited by package.
2. Pulse width limited by T_{jmax}
3. $I_{SD} \leq 7\text{ A}$, $di/dt \leq 400\text{ A}/\mu\text{s}$; $V_{DS\ peak} < V_{(BR)DSS}$, $V_{DD} = 80\% V_{(BR)DSS}$.
4. $V_{DS} \leq 520\text{ V}$

Table 3. Thermal data

Symbol	Parameter	Value			Unit
		DPAK	TO-220	IPAK	
$R_{thj-case}$	Thermal resistance junction-case max	1.47			°C/W
$R_{thj-amb}$	Thermal resistance junction-amb max		62.5	100	°C/W
$R_{thj-pcb}^{(1)}$	Thermal resistance junction-pcb max	50			°C/W

1. When mounted on 1 inch² FR-4 board, 2 oz Cu

Table 4. Avalanche characteristics

Symbol	Parameter	Value	Unit
I_{AR}	Avalanche current, repetitive or not repetitive (pulse width limited by T_{jmax})	1.5	A
E_{AS}	Single pulse avalanche energy (starting $T_j = 25\text{ }^\circ\text{C}$, $I_D = I_{AR}$; $V_{DD} = 50$)	110	mJ

2 Electrical characteristics

($T_C = 25\text{ °C}$ unless otherwise specified)

Table 5. On /off states

Symbol	Parameter	Test conditions	Min.	Typ.	Max.	Unit
$V_{(BR)DSS}$	Drain-source breakdown voltage	$V_{GS} = 0, I_D = 1\text{ mA}$	650			V
I_{DSS}	Zero gate voltage drain current	$V_{GS} = 0, V_{DS} = 650\text{ V}$			1	μA
		$V_{GS} = 0, V_{DS} = 650\text{ V}, T_C = 125\text{ °C}$			100	μA
I_{GSS}	Gate-body leakage current	$V_{DS} = 0, V_{GS} = \pm 25\text{ V}$			± 10	μA
$V_{GS(th)}$	Gate threshold voltage	$V_{DS} = V_{GS}, I_D = 250\text{ }\mu\text{A}$	2	3	4	V
$R_{DS(on)}$	Static drain-source on-resistance	$V_{GS} = 10\text{ V}, I_D = 3.5\text{ A}$		0.6	0.67	Ω

Table 6. Dynamic

Symbol	Parameter	Test conditions	Min.	Typ.	Max.	Unit
C_{iss}	Input capacitance	$V_{GS} = 0, V_{DS} = 100\text{ V}, f = 1\text{ MHz},$	-	410	-	pF
C_{oss}	Output capacitance		-	20	-	pF
C_{rss}	Reverse transfer capacitance		-	0.95	-	pF
$C_{oss\text{ eq.}}^{(1)}$	Equivalent output capacitance	$V_{GS} = 0, V_{DS} = 0\text{ to }520\text{ V}$	-	83	-	pF
R_G	Intrinsic gate resistance	$f = 1\text{ MHz}, I_D = 0$	-	6.4	-	Ω
Q_g	Total gate charge	$V_{DD} = 520\text{ V}, I_D = 7\text{ A}, V_{GS} = 10\text{ V}$ (see Figure 17)	-	12.5	-	nC
Q_{gs}	Gate-source charge		-	3.2	-	nC
Q_{gd}	Gate-drain charge		-	5.8	-	nC

1. $C_{oss\text{ eq.}}$ is defined as a constant equivalent capacitance giving the same charging time as C_{oss} when V_{DS} increases from 0 to 80% V_{DSS}

Table 7. Switching times

Symbol	Parameter	Test conditions	Min.	Typ.	Max.	Unit
$t_{d(on)}$	Turn-on delay time	$V_{DD} = 325\text{ V}$, $I_D = 3.5\text{ A}$, $R_G = 4.7\ \Omega$, $V_{GS} = 10\text{ V}$ (see Figure 16 and 21)	-	9.5	-	ns
t_r	Rise time		-	7.5	-	ns
$t_{d(off)}$	Turn-off delay time		-	26	-	ns
t_f	Fall time		-	15	-	ns

Table 8. Source drain diode

Symbol	Parameter	Test conditions	Min.	Typ.	Max.	Unit
I_{SD}	Source-drain current		-		7	A
$I_{SDM}^{(1)(2)}$	Source-drain current (pulsed)		-		28	A
$V_{SD}^{(3)}$	Forward on voltage	$V_{GS} = 0$, $I_{SD} = 7\text{ A}$	-		1.6	V
t_{rr}	Reverse recovery time	$I_{SD} = 7\text{ A}^{(2)}$, $di/dt = 100\text{ A}/\mu\text{s}$ $V_{DD} = 60\text{ V}$ (see Figure 18)	-	318		ns
Q_{rr}	Reverse recovery charge		-	2.5		nC
I_{RRM}	Reverse recovery current		-	15.5		A
t_{rr}	Reverse recovery time	$I_{SD} = 7\text{ A}$, $di/dt = 100\text{ A}/\mu\text{s}$ $V_{DD} = 60\text{ V}$, $T_j = 150\text{ }^\circ\text{C}$ (see Figure 18)	-	437		ns
Q_{rr}	Reverse recovery charge		-	3.2		nC
I_{RRM}	Reverse recovery current		-	15		A

1. Pulse width limited by safe operating area
2. Test condition is referred to through-hole package
3. Pulsed: pulse duration = 300 μs , duty cycle 1.5%

2.1 Electrical characteristics (curves)

Figure 2. Safe operating area for DPAK and IPAK

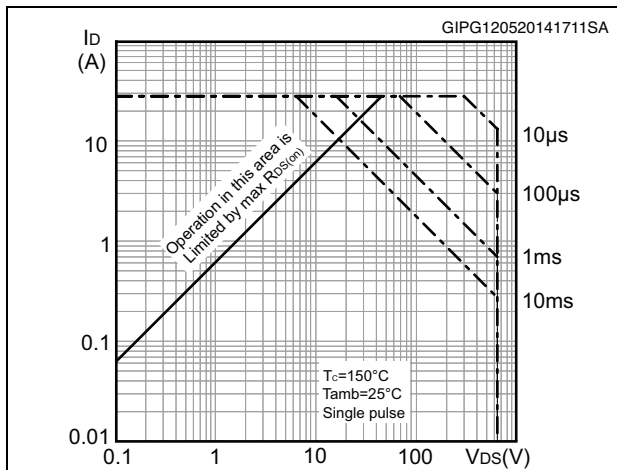

Figure 3. Thermal impedance for DPAK and IPAK

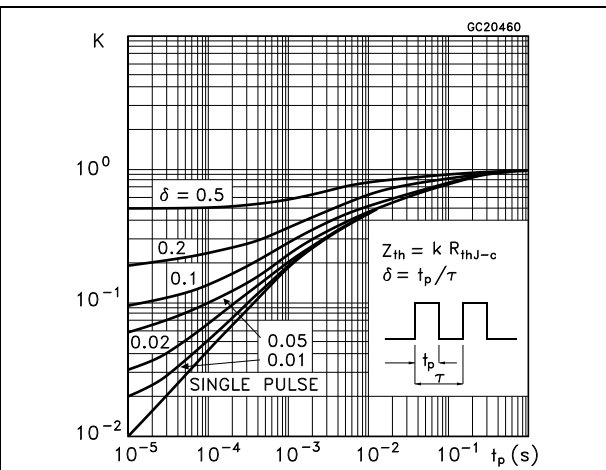

Figure 4. Safe operating area for TO-220

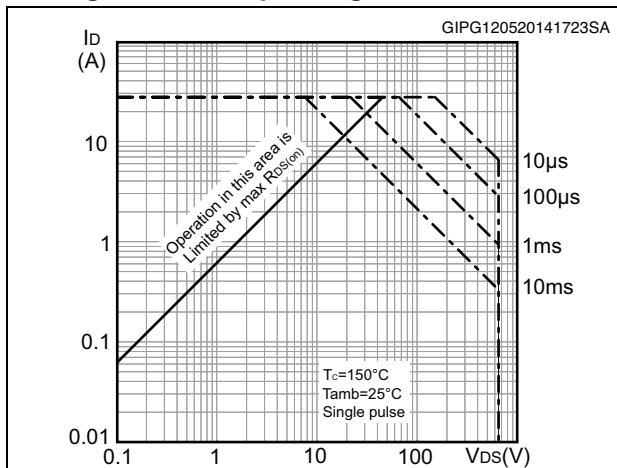

Figure 5. Thermal impedance for TO-220

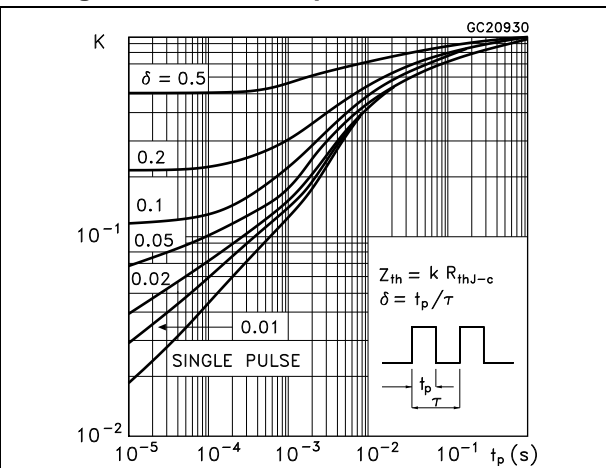

Figure 6. Output characteristics

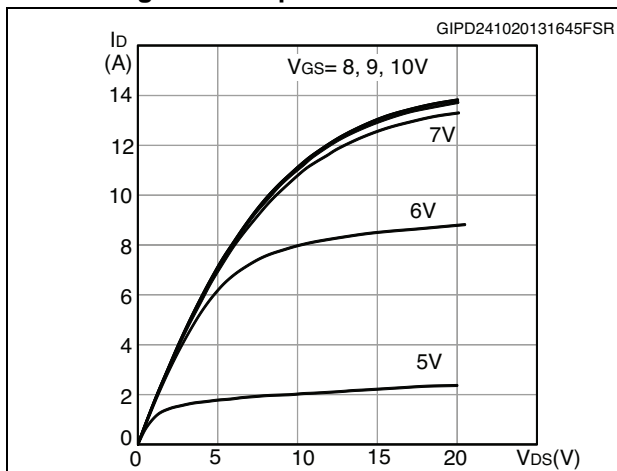

Figure 7. Transfer characteristics

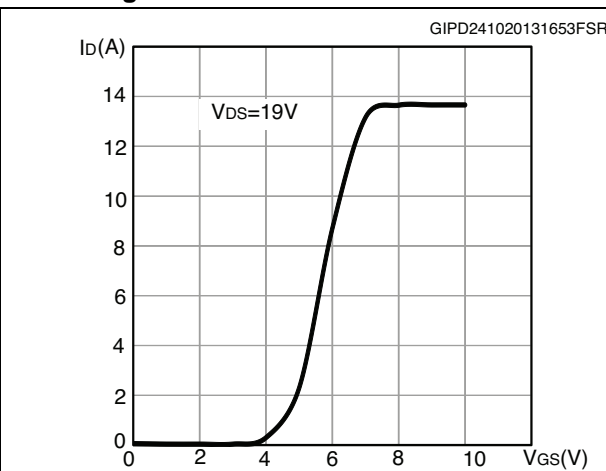

Figure 8. Normalized $V_{(BR)DSS}$ vs temperature

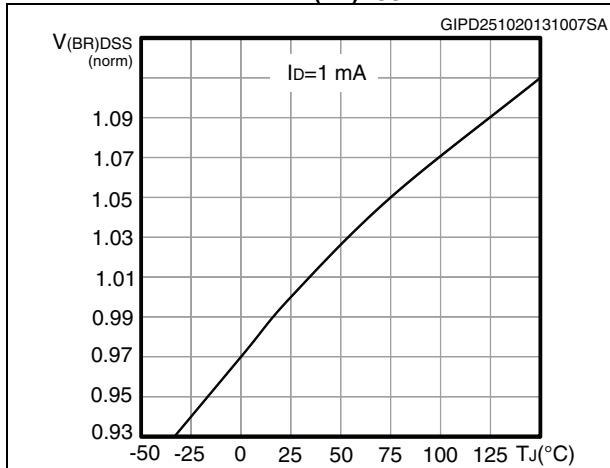

Figure 9. Static drain-source on-resistance

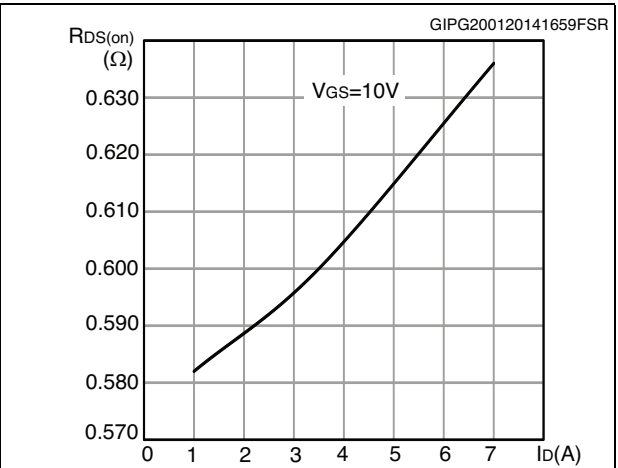

Figure 10. Gate charge vs gate-source voltage

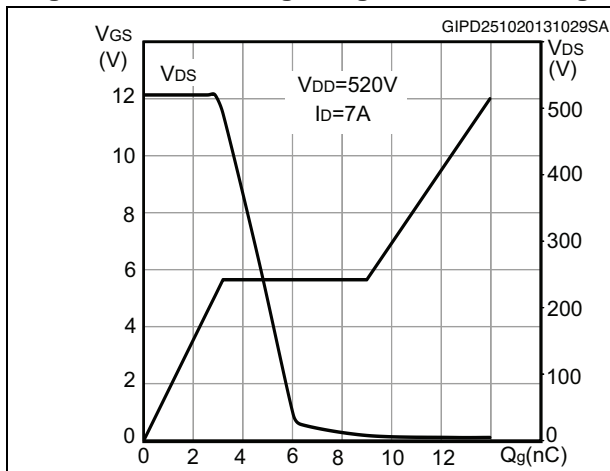

Figure 11. Capacitance variations

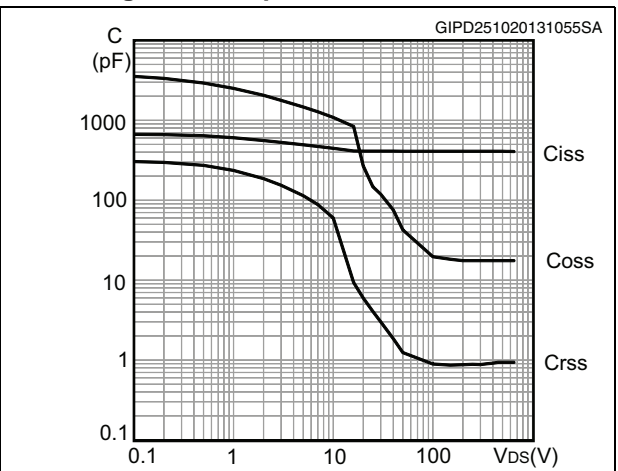

Figure 12. Normalized gate threshold voltage vs temperature

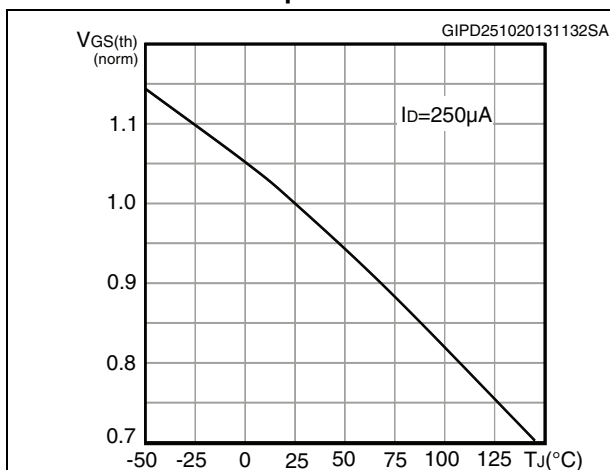

Figure 13. Normalized on-resistance vs temperature

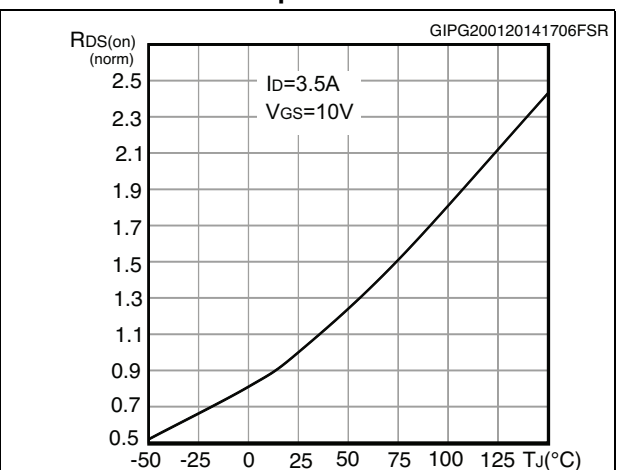

Figure 14. Source-drain diode forward characteristics

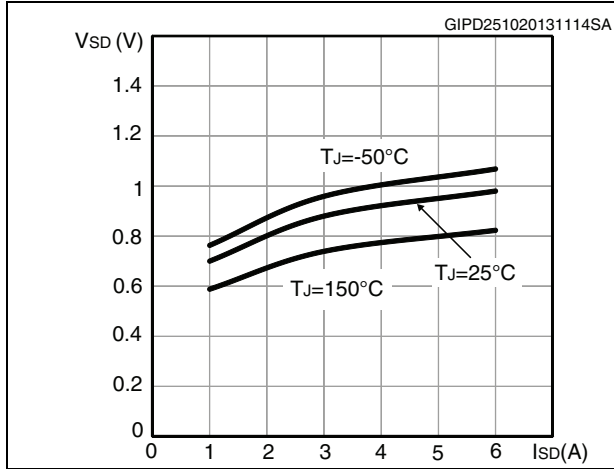
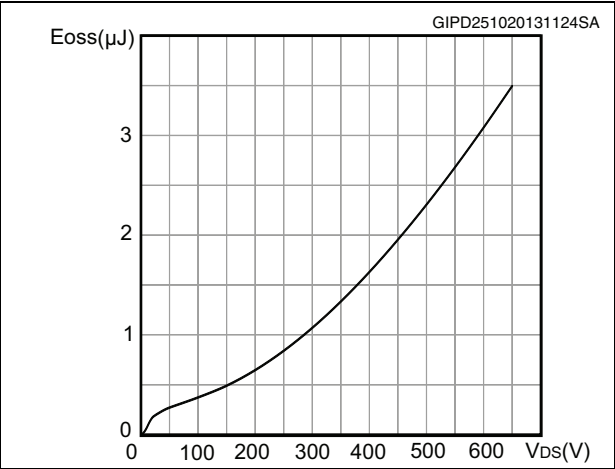

Figure 15. Output capacitance stored energy



3 Test circuits

Figure 16. Switching times test circuit for resistive load



Figure 17. Gate charge test circuit



Figure 18. Test circuit for inductive load switching and diode recovery times



Figure 19. Unclamped inductive load test circuit



Figure 20. Unclamped inductive waveform

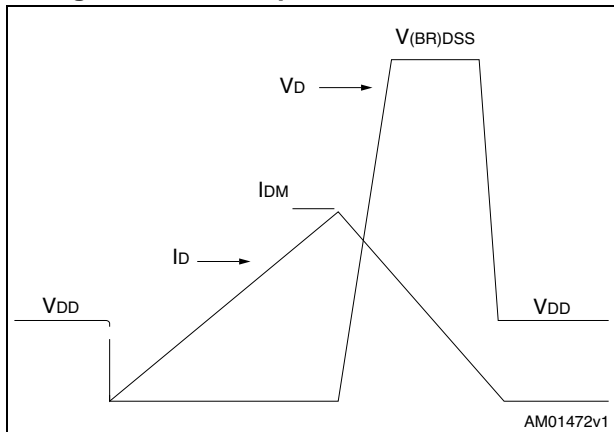

Figure 21. Switching time waveform



4 Package mechanical data

In order to meet environmental requirements, ST offers these devices in different grades of ECOPACK[®] packages, depending on their level of environmental compliance. ECOPACK[®] specifications, grade definitions and product status are available at: www.st.com. ECOPACK[®] is an ST trademark.

4.1 DPAK, STD11N65M2

Figure 22. DPAK (TO-252) type A drawing

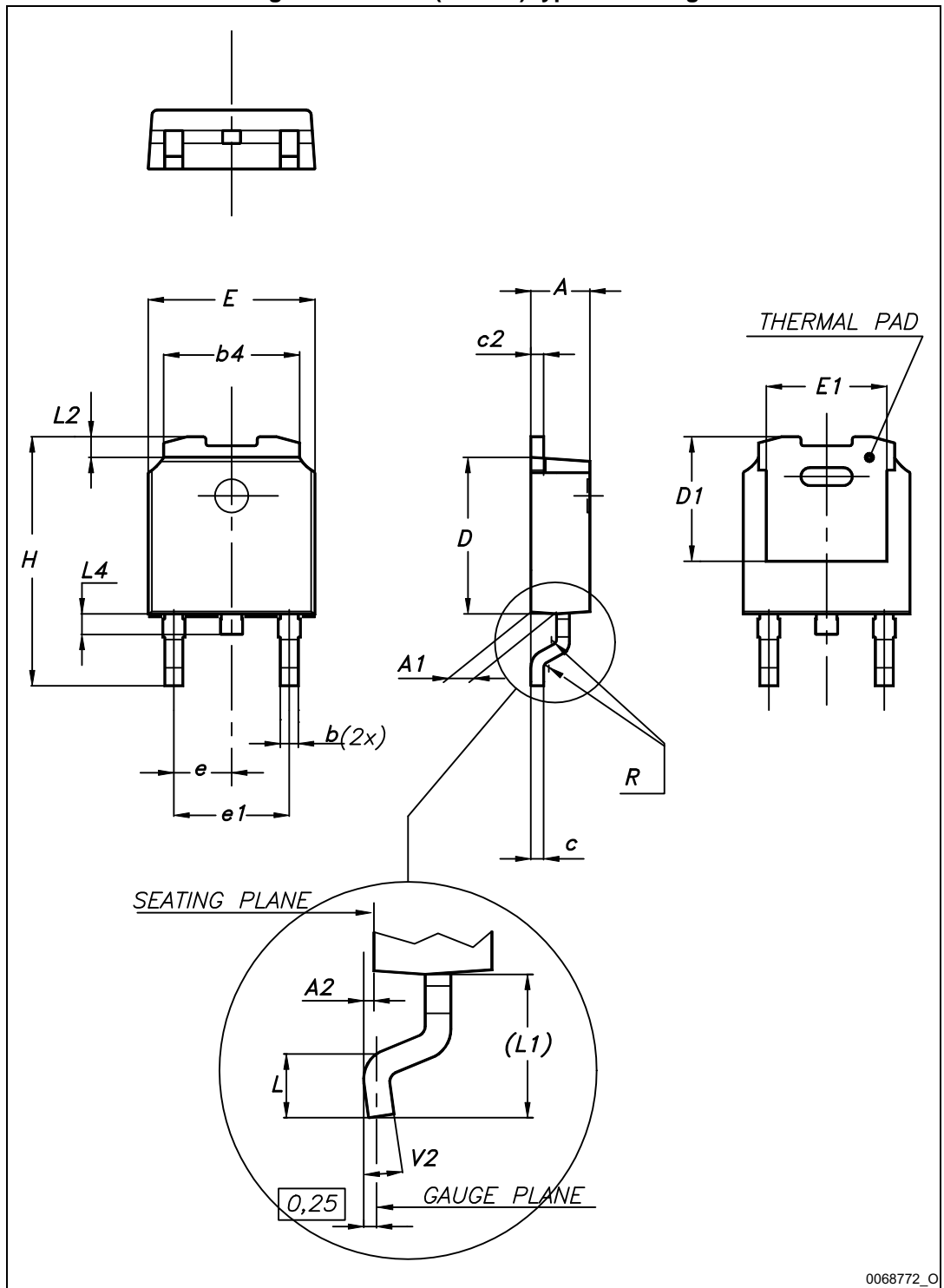

0068772_0

Table 9. DPAK (TO-252) type A mechanical data

Dim.	mm		
	Min.	Typ.	Max.
A	2.20		2.40
A1	0.90		1.10
A2	0.03		0.23
b	0.64		0.90
b4	5.20		5.40
c	0.45		0.60
c2	0.48		0.60
D	6.00		6.20
D1		5.10	
E	6.40		6.60
E1		4.70	
e		2.28	
e1	4.40		4.60
H	9.35		10.10
L	1.00		1.50
(L1)		2.80	
L2		0.80	
L4	0.60		1.00
R		0.20	
V2	0°		8°

Figure 23. DPAK (TO-252) type A footprint (a)

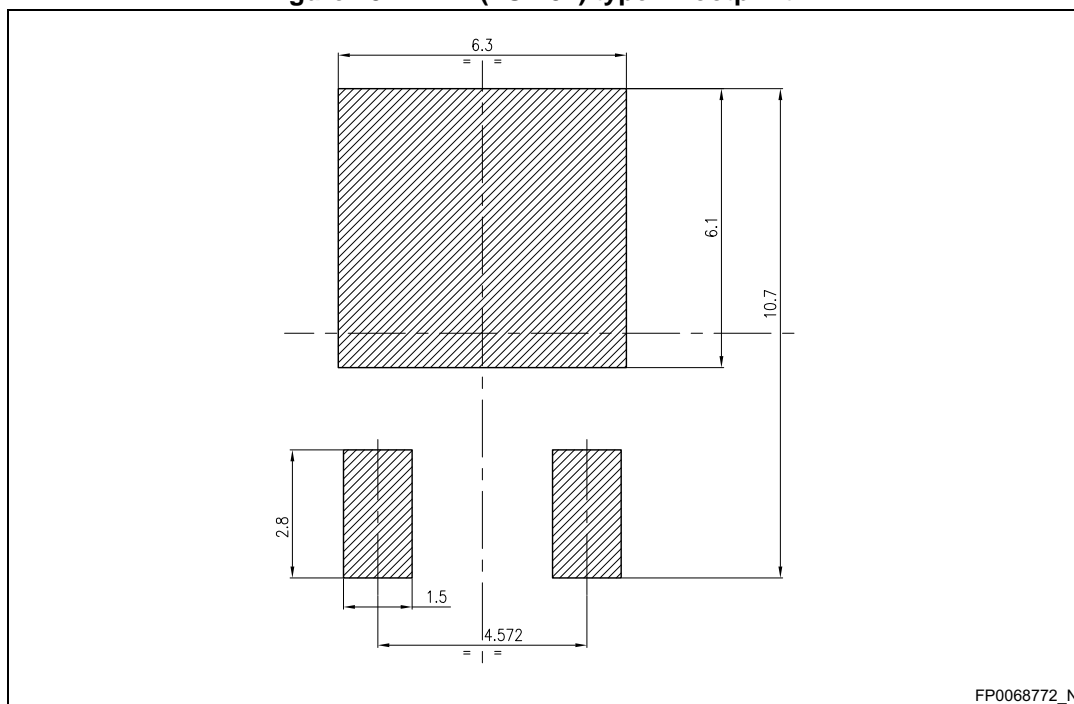

a. All dimensions are in millimeters

Table 10. TO-220 type A mechanical data

Dim.	mm		
	Min.	Typ.	Max.
A	4.40		4.60
b	0.61		0.88
b1	1.14		1.70
c	0.48		0.70
D	15.25		15.75
D1		1.27	
E	10		10.40
e	2.40		2.70
e1	4.95		5.15
F	1.23		1.32
H1	6.20		6.60
J1	2.40		2.72
L	13		14
L1	3.50		3.93
L20		16.40	
L30		28.90	
ØP	3.75		3.85
Q	2.65		2.95

4.3 IPAK, STU11N65M2

Figure 25. IPAK (TO-251) drawing

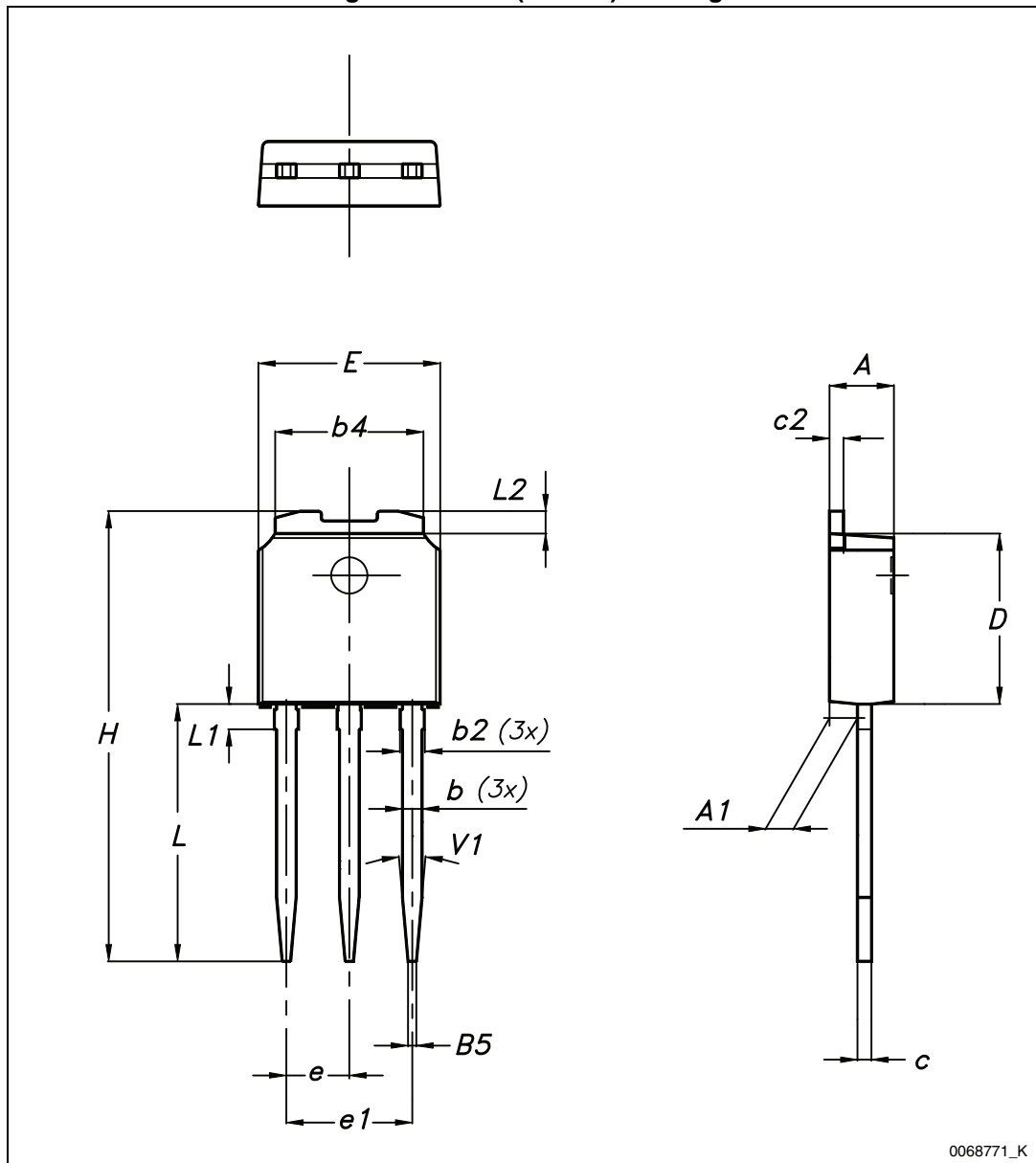

Table 11. IPAK (TO-251) mechanical data

DIM	mm.		
	min.	typ.	max.
A	2.20		2.40
A1	0.90		1.10
b	0.64		0.90
b2			0.95
b4	5.20		5.40
B5		0.30	
c	0.45		0.60
c2	0.48		0.60
D	6.00		6.20
E	6.40		6.60
e		2.28	
e1	4.40		4.60
H		16.10	
L	9.00		9.40
L1	0.80		1.20
L2		0.80	1.00
V1		10°	

5 Packaging mechanical data

Figure 26. Tape for DPAK (TO-252)

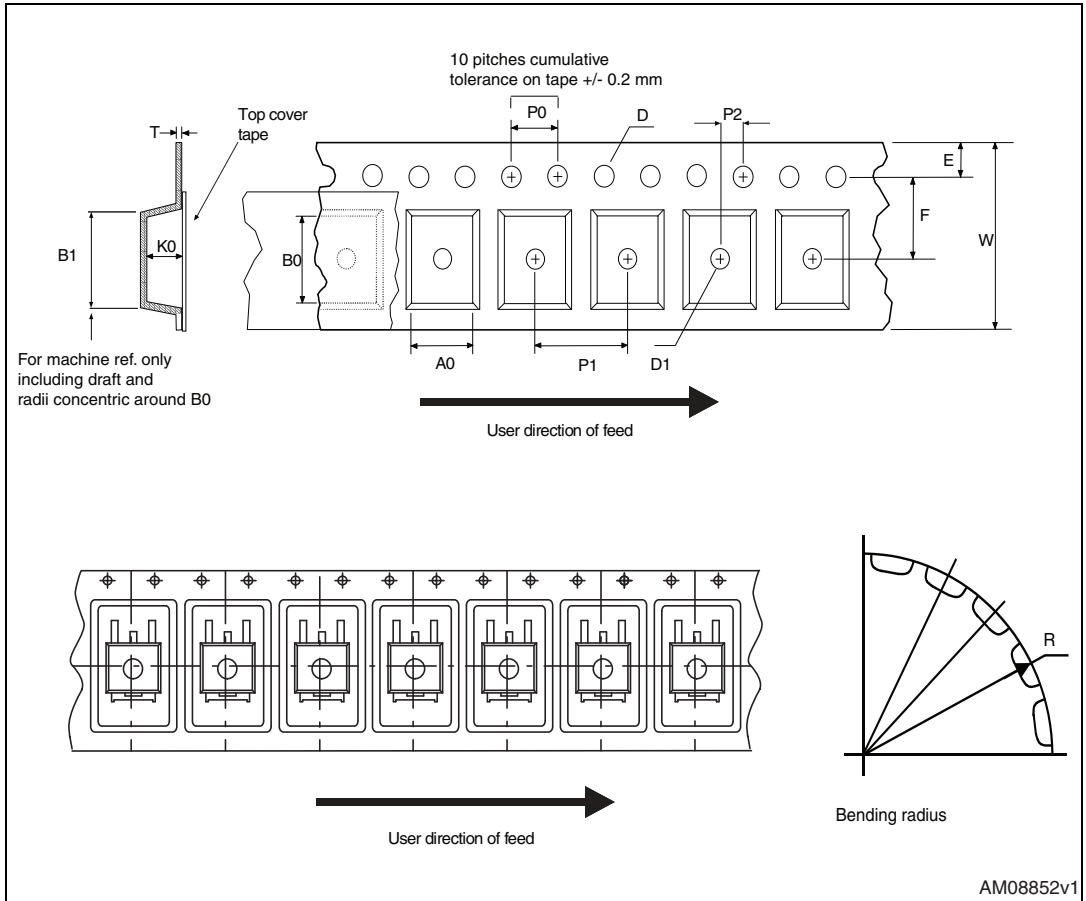

Figure 27. Reel for DPAK (TO-252)

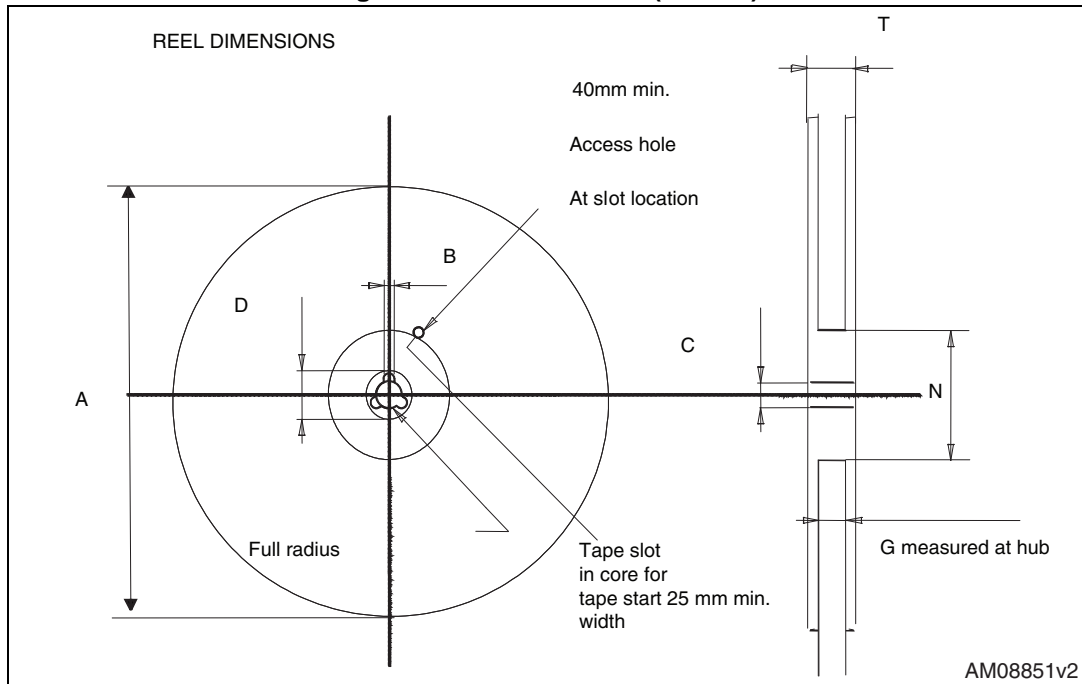

Table 12. DPAK (TO-252) tape and reel mechanical data

Tape			Reel		
Dim.	mm		Dim.	mm	
	Min.	Max.		Min.	Max.
A0	6.8	7	A		330
B0	10.4	10.6	B	1.5	
B1		12.1	C	12.8	13.2
D	1.5	1.6	D	20.2	
D1	1.5		G	16.4	18.4
E	1.65	1.85	N	50	
F	7.4	7.6	T		22.4
K0	2.55	2.75			
P0	3.9	4.1		Base qty.	2500
P1	7.9	8.1		Bulk qty.	2500
P2	1.9	2.1			
R	40				
T	0.25	0.35			
W	15.7	16.3			

6 Revision history

Table 13. Document revision history

Date	Revision	Changes
16-May-2014	1	First release.

Please Read Carefully:

Information in this document is provided solely in connection with ST products. STMicroelectronics NV and its subsidiaries ("ST") reserve the right to make changes, corrections, modifications or improvements, to this document, and the products and services described herein at any time, without notice.

All ST products are sold pursuant to ST's terms and conditions of sale.

Purchasers are solely responsible for the choice, selection and use of the ST products and services described herein, and ST assumes no liability whatsoever relating to the choice, selection or use of the ST products and services described herein.

No license, express or implied, by estoppel or otherwise, to any intellectual property rights is granted under this document. If any part of this document refers to any third party products or services it shall not be deemed a license grant by ST for the use of such third party products or services, or any intellectual property contained therein or considered as a warranty covering the use in any manner whatsoever of such third party products or services or any intellectual property contained therein.

UNLESS OTHERWISE SET FORTH IN ST'S TERMS AND CONDITIONS OF SALE ST DISCLAIMS ANY EXPRESS OR IMPLIED WARRANTY WITH RESPECT TO THE USE AND/OR SALE OF ST PRODUCTS INCLUDING WITHOUT LIMITATION IMPLIED WARRANTIES OF MERCHANTABILITY, FITNESS FOR A PARTICULAR PURPOSE (AND THEIR EQUIVALENTS UNDER THE LAWS OF ANY JURISDICTION), OR INFRINGEMENT OF ANY PATENT, COPYRIGHT OR OTHER INTELLECTUAL PROPERTY RIGHT.

ST PRODUCTS ARE NOT DESIGNED OR AUTHORIZED FOR USE IN: (A) SAFETY CRITICAL APPLICATIONS SUCH AS LIFE SUPPORTING, ACTIVE IMPLANTED DEVICES OR SYSTEMS WITH PRODUCT FUNCTIONAL SAFETY REQUIREMENTS; (B) AERONAUTIC APPLICATIONS; (C) AUTOMOTIVE APPLICATIONS OR ENVIRONMENTS, AND/OR (D) AEROSPACE APPLICATIONS OR ENVIRONMENTS. WHERE ST PRODUCTS ARE NOT DESIGNED FOR SUCH USE, THE PURCHASER SHALL USE PRODUCTS AT PURCHASER'S SOLE RISK, EVEN IF ST HAS BEEN INFORMED IN WRITING OF SUCH USAGE, UNLESS A PRODUCT IS EXPRESSLY DESIGNATED BY ST AS BEING INTENDED FOR "AUTOMOTIVE, AUTOMOTIVE SAFETY OR MEDICAL" INDUSTRY DOMAINS ACCORDING TO ST PRODUCT DESIGN SPECIFICATIONS. PRODUCTS FORMALLY ESCC, QML OR JAN QUALIFIED ARE DEEMED SUITABLE FOR USE IN AEROSPACE BY THE CORRESPONDING GOVERNMENTAL AGENCY.

Resale of ST products with provisions different from the statements and/or technical features set forth in this document shall immediately void any warranty granted by ST for the ST product or service described herein and shall not create or extend in any manner whatsoever, any liability of ST.

ST and the ST logo are trademarks or registered trademarks of ST in various countries.

Information in this document supersedes and replaces all information previously supplied.

The ST logo is a registered trademark of STMicroelectronics. All other names are the property of their respective owners.

© 2014 STMicroelectronics - All rights reserved

STMicroelectronics group of companies

Australia - Belgium - Brazil - Canada - China - Czech Republic - Finland - France - Germany - Hong Kong - India - Israel - Italy - Japan - Malaysia - Malta - Morocco - Philippines - Singapore - Spain - Sweden - Switzerland - United Kingdom - United States of America

www.st.com

