

N-Channel MOSFET

2SK1284-Z

■ Features

- Low on-state resistance
 $R_{DS(on)} \leq 0.32 \Omega$ @ $V_{GS}=10V, I_D=2A$
 $R_{DS(on)} \leq 0.40 \Omega$ @ $V_{GS}=4V, I_D=2A$
- Low Ciss Ciss=500pF TYP.
- Built-in G-S Gate Protection Diode

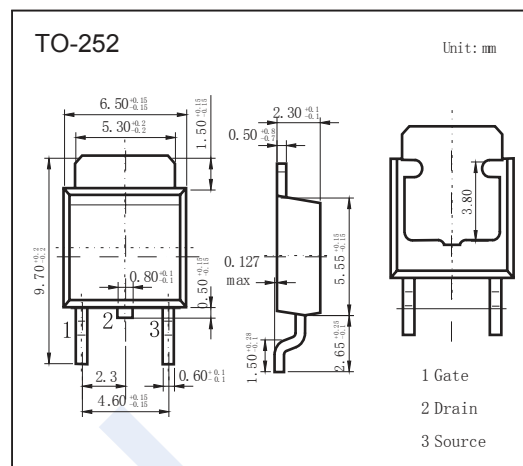
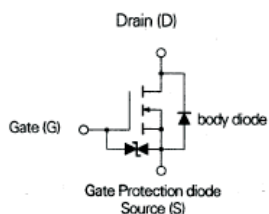

■ Absolute Maximum Ratings $T_a = 25^\circ\text{C}$

Parameter	Symbol	Rating	Unit
Drain to source voltage	V_{DSS}	100	V
Gate to source voltage	V_{GSS}	± 20	V
Drain current (DC)	I_D	3	A
Pulsed Drain Current *	I_{DM}	12	A
Power dissipation	P_D	$T_c=25^\circ\text{C}$	20
		$T_A=25^\circ\text{C}$	1
Junction Temperature	T_j	150	$^\circ\text{C}$
Storage temperature	T_{stg}	-55 to +150	$^\circ\text{C}$

* $PW \leq 10 \mu\text{s}$, duty cycle $\leq 5\%$

N-Channel MOSFET

2SK1284-Z

■ Electrical Characteristics Ta = 25°C

Parameter	Symbol	Test Conditions	Min	Typ	Max	Unit
Drain-Source Breakdown Voltage	V _{DSS}	I _D =250 μA, V _{GS} =0V	100			V
Zero Gate Voltage Drain Current	I _{DSS}	V _{DS} =100V, V _{GS} =0V			10	μA
Gate-Body Leakage Current	I _{GSS}	V _{DS} =0V, V _{GS} =±10V			±10	μA
Gate Cut-off Voltage	V _{GS(off)}	V _{DS} =10 V I _D =1mA	1		2.5	V
Static Drain-Source On-Resistance	R _{DS(on)}	V _{GS} =10V, I _D =2 A			320	mΩ
		V _{GS} =4V, I _D =2 A			400	
Forward Transconductance	g _{FS}	V _{DS} =10V, I _D =2 A	2.4			S
Input Capacitance	C _{iss}	V _{GS} =0V, V _{DS} =10V, f=1MHz		500		pF
Output Capacitance	C _{oss}			160		
Reverse Transfer Capacitance	C _{rss}			20		
Total Gate Charge	Q _g	V _{GS} =10V, V _{DS} =80V, I _D =3A		13		nC
Gate Source Charge	Q _{gs}			3		
Gate Drain Charge	Q _{gd}			2		
Turn-On DelayTime	t _{d(on)}	V _{GS} =10V, V _{DS} =50V, I _D =2A, R _L =25 Ω, R _G =10 Ω		40		ns
Turn-On Rise Time	t _r			55		
Turn-Off DelayTime	t _{d(off)}			500		
Turn-Off Fall Time	t _f			120		
Body Diode Reverse Recovery Time	t _{rr}	I _F = 3A, V _{GS} =0, di/dt= 50A/μs		140		nC
Body Diode Reverse Recovery Charge	Q _{rr}			250		
Diode Forward Voltage	V _{SD}	I _S =3A, V _{GS} =0V		0.9		V

N-Channel MOSFET 2SK1284-Z

■ Typical Characteristics

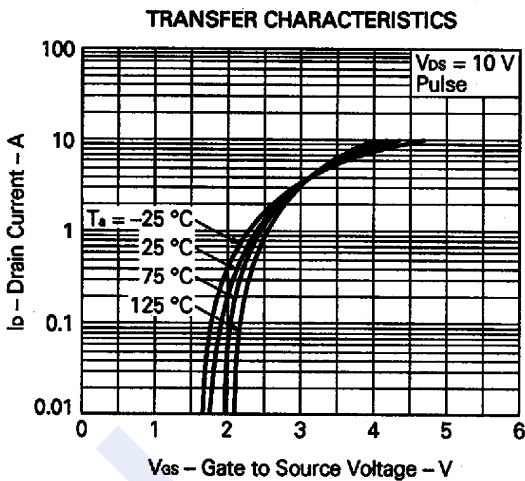
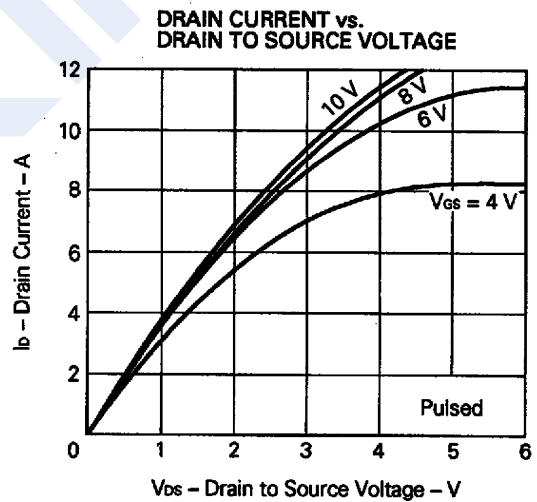
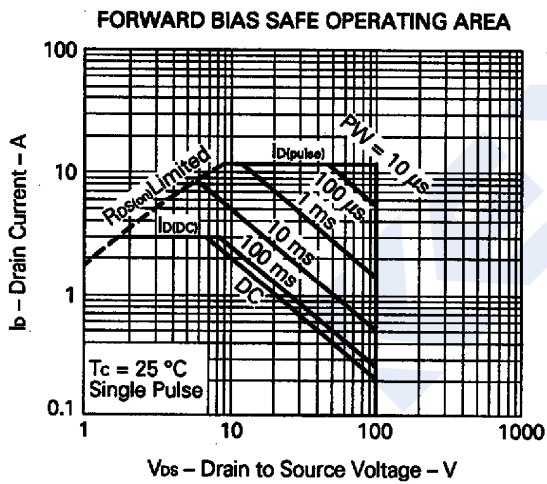
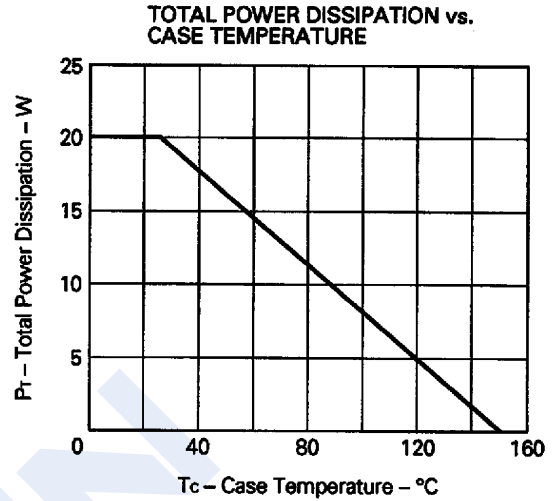
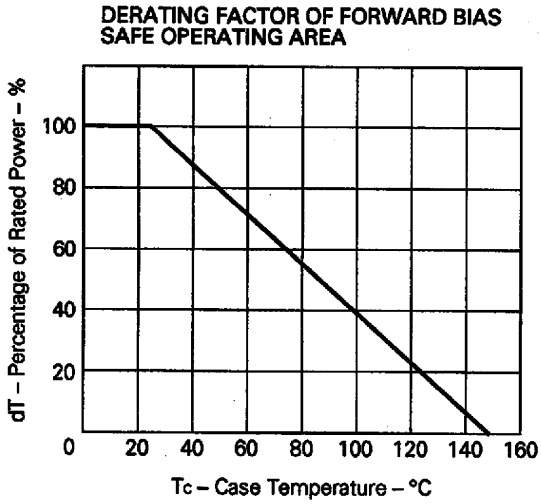

N-Channel MOSFET 2SK1284-Z

■ Typical Characteristics

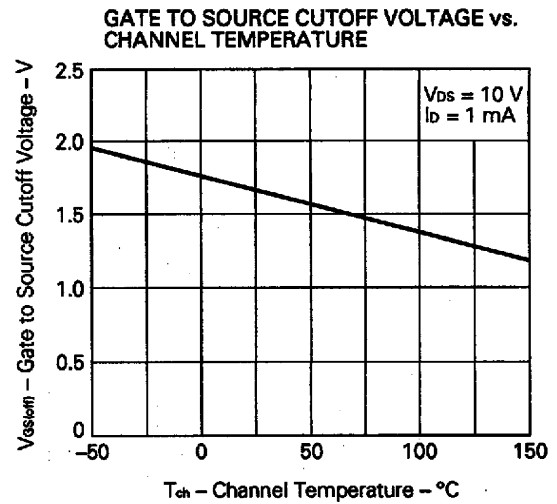
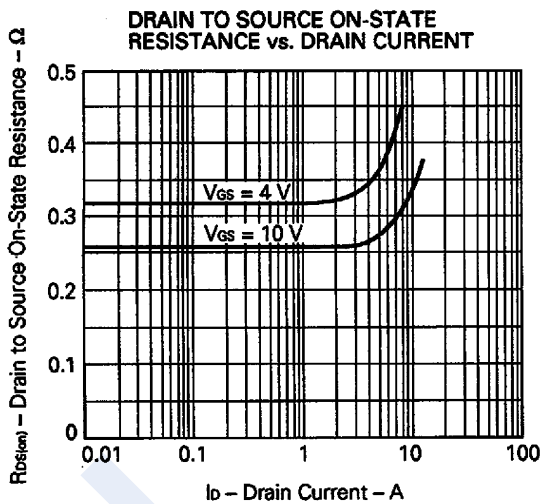
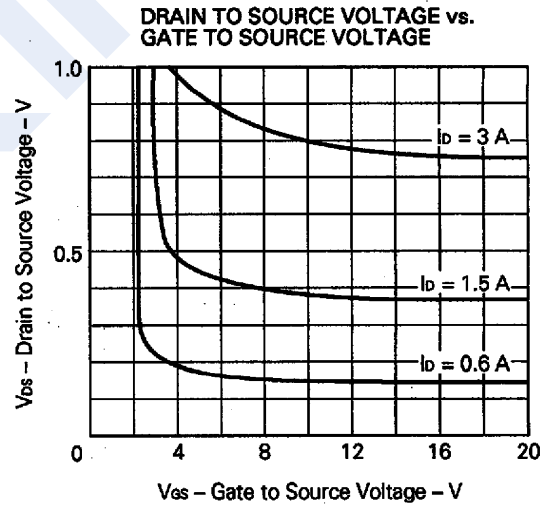
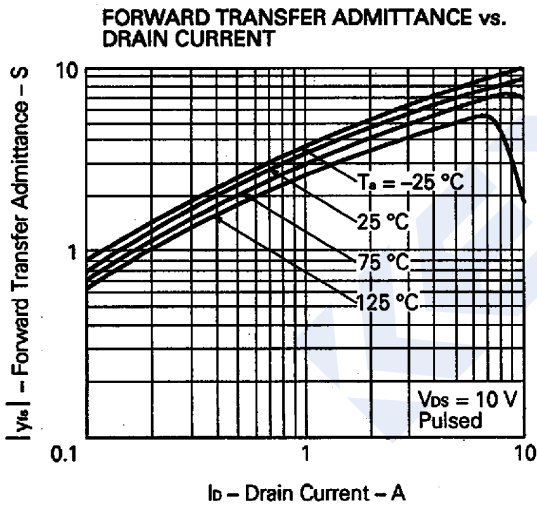
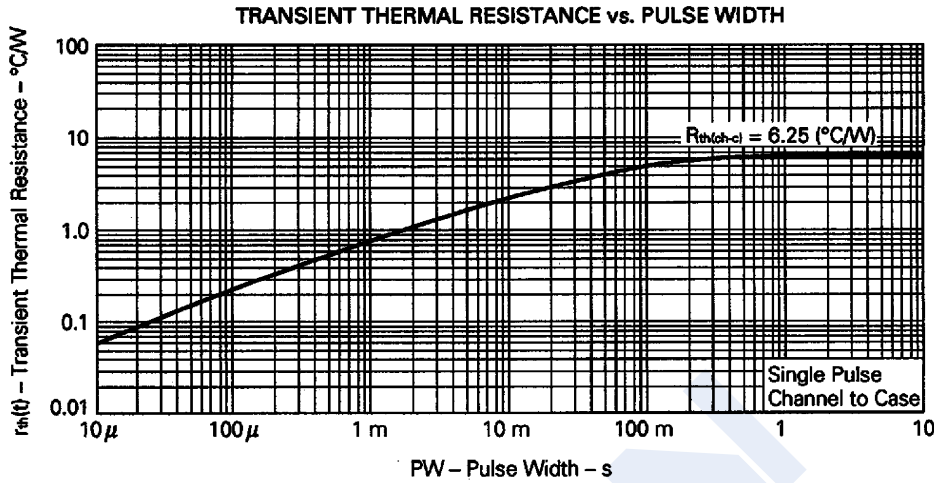

N-Channel MOSFET 2SK1284-Z

■ Typical Characteristics

