



YENYO

HFR8A12D

Glass Passivated Hyperfast Recovery Rectifier

Features

- * Fast switching for high efficiency
- * Low noise
- * $T_{rr} = 25\text{ns}$
- * Low reverse leakage current
- * High voltage super FRD
- * PFC application

Mechanical Data

- * Case: Molded plastic TO-220AC
- * Epoxy: UL 94V-0 rate flame retardant
- * Terminals: Solderable per MIL-STD-202 method 208
- * Mounting position: Any
- * Weight: 2.07 grams

Voltage Range 1200 V
Current 8.0 Ampere

TO-220AC

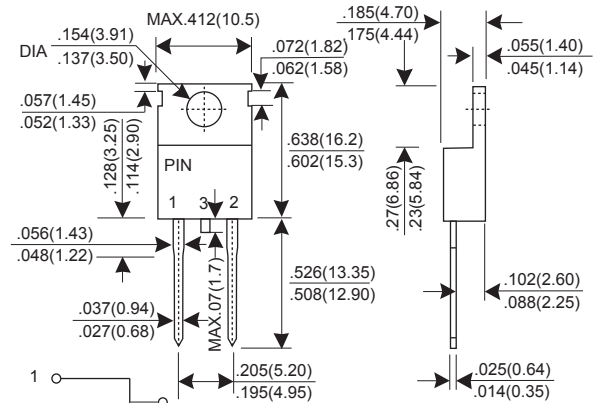

Dimensions in inches and (millimeters)

Maximum Ratings $T_c = 25^\circ\text{C}$, Unless Otherwise Specified

Item	Symbol	Conditions	UNIT
Recurrent Peak Reverse Voltage	VRRM	1200	V
RMS Voltage	VRMS	840	V
DC Blocking Voltage	VDC	1200	V
Average Forward Rectified Current $T_c=140^\circ\text{C}$	IF(AV)	8.0	A
Peak Forward Surge Current, 8.3ms single Half sine-wave superimposed on rated load (JEDEC method)	IFSM	100	A
Operating Junction and Storage Temperature Range	TJ, TSTG	-65 ~ +175	$^\circ\text{C}$

Electrical/Thermal Characteristics $T_c = 25^\circ\text{C}$, Unless Otherwise Specified

Item	Symbol	Conditions	Min.	Typ.	Max.	UNIT
Instantaneous Forward Voltage	VF	IF = 8A	-	-	4.5	V
DC Reverse Current At Rated DC Blocking Voltage	IR	VR = 1200V VR = 1200V $T_J=150^\circ\text{C}$	-	-	10.0 500	μA μA
Maximum Reverse Recovery Time	Trr	IF = 0.5A, IR = 1.0A, Irr = 0.25A	-	-	25	nS
Typical junction Capacitance	CJ	VR = 10V, IF = 0A	-	25	-	pF
Typical Thermal Resistance	R θ /C	Junction to Case	-	-	2	$^\circ\text{C}/\text{W}$

RATINGS AND CHARACTERISTIC CURVES HFR8A12D

FIG.1 - FORWARD CURRENT DERATING CURVE

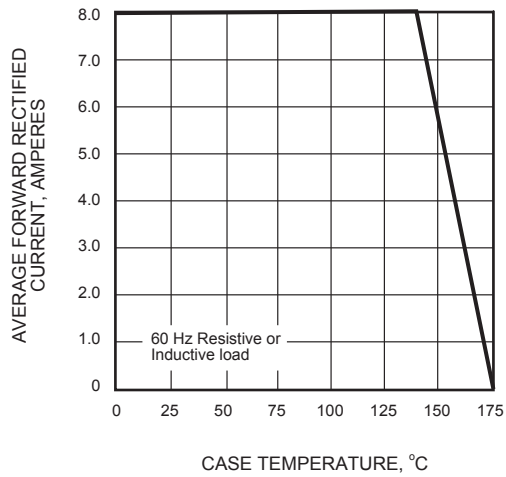

FIG.2 - MAXIMUM NON-REPETITIVE PEAK FORWARD SURGE CURRENT

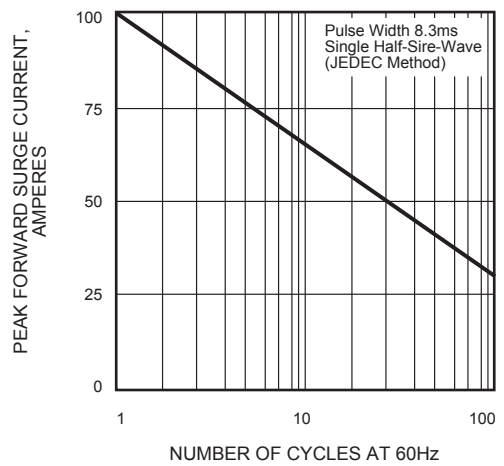

FIG.3 - TYPICAL INSTANTANEOUS FORWARD CHARACTERISTICS

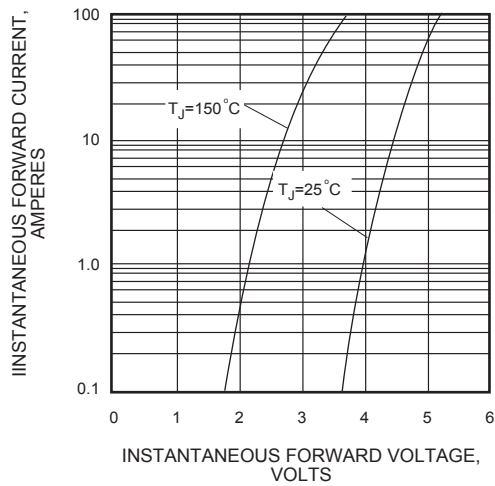

FIG.4 - TYPICAL REVERSE CHARACTERISTICS

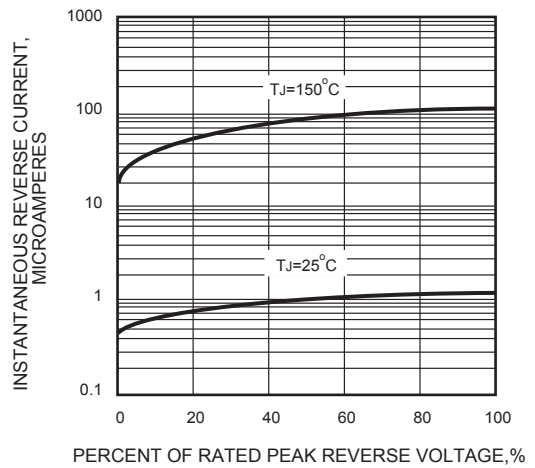
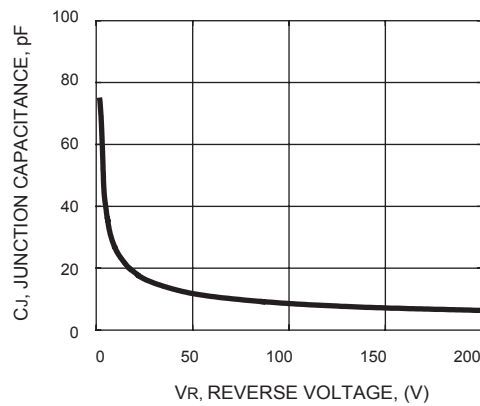

FIG.5 - JUNCTION CAPACITANCE vs REVERSE VOLTAGE



Test Circuits and Waveforms

FIG.6 t_{rr} TEST CIRCUIT

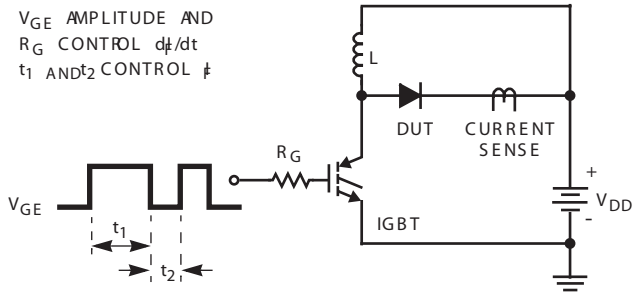

FIG. 7 t_{rr} WAVEFORMS AND DEFINITIONS

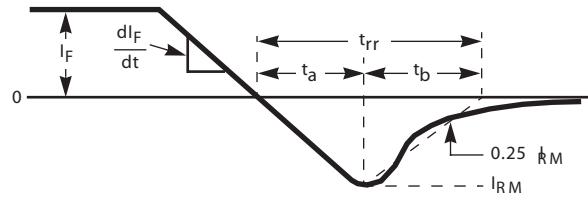

FIG. 8 AVALANCHE ENERGY TEST CIRCUIT

$I_{MAX} = 1A$
 $L = 40mH$
 $R < 0.1$
 $E_{AVL} = 1/2 L I_L^2 [V_{R(AVL)} / (V_{R(AVL)} - V_{DD})]$
 $Q_1 = IGBT (BV_{ES} > DU V_{R(AVL)})$

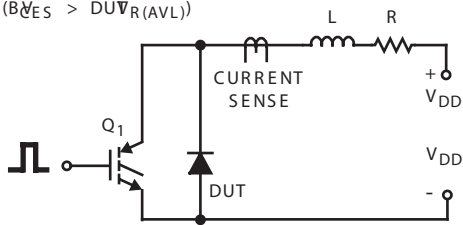

FIG.9 -AVALANCHE CURRENT AND VOLTAGE WAVEFORMS

