

DDR3L SDRAM VLP Registered DIMM Based on 4Gb M-die

HMT451V7MFR8A
HMT41GV7MFR4A
HMT41GV7MFR8A
HMT82GV7MMR4A
HMT82GV7MMR8A

*SK hynix reserves the right to change products or specifications without notice.

Revision History

| Revision No. | History | Draft Date | Remark |
|--------------|---------------------------|------------|--------|
| 0.1 | Initial Release | Dec.2011 | |
| 1.0 | Latest JEDEC Spec Updated | Aug.2012 | |

Description

SK hynix VLP (Very Low Profile) registered DDR3L SDRAM DIMMs (Registered Double Data Rate Synchronous DRAM Dual In-Line Memory Modules) are low power, high-speed operation memory modules that use DDR3L SDRAM devices. These Registered SDRAM DIMMs are intended for use as main memory when installed in systems such as servers and workstations.

Features

- Power Supply: VDD=1.35V (1.283V to 1.45V)
- VDDQ = 1.35V (1.283V to 1.45V)
- VDDSPD=3.0V to 3.6V
- Functionality and operations comply with the DDR3L SDRAM datasheet
- 8 internal banks
- Data transfer rates: PC3-10600, PC3-8500
- Bi-Directional Differential Data Strobe
- 8 bit pre-fetch
- Burst Length (BL) switch on-the-fly BL8 or BC4(Burst Chop)
- Supports ECC error correction and detection
- On-Die Termination (ODT)
- Temperature sensor with integrated SPD
- This product is in compliance with the RoHS directive.

Ordering Information

| Part Number | Density | Organization | Component Composition | # of ranks | FDHS |
|---------------------|---------|--------------|--------------------------|------------|------|
| HMT451V7MFR8A-G7/H9 | 4GB | 512Mx72 | 512Mx8(H5TC4G83MFR)*9 | 1 | X |
| HMT41GV7MFR4A-G7/H9 | 8GB | 1Gx72 | 1Gx4(H5TC4G43MFR)*18 | 1 | X |
| HMT41GV7MFR8A-G7/H9 | 8GB | 1Gx72 | 512Mx8(H5TC4G83MFR)*18 | 2 | X |
| HMT82GV7MMR4A-G7/H9 | 16GB | 2Gx72 | DDP 2Gx4(H5TC8G43MMR)*36 | 2 | O |
| HMT82GV7MMR8A-G7/H9 | 16GB | 2Gx72 | DDP 1Gx8(H5TC8G83MMR)*36 | 4 | O |

* In order to uninstall FDHS, please contact sales administrator

Key Parameters

| MT/s | Grade | tCK (ns) | CAS Latency (tCK) | tRCD (ns) | tRP (ns) | tRAS (ns) | tRC (ns) | CL-tRCD-tRP |
|------------|-------|----------|-------------------|-------------------|-------------------|-----------|-------------------|-------------|
| DDR3L-1066 | -G7 | 1.875 | 7 | 13.125 | 13.125 | 37.5 | 50.625 | 7-7-7 |
| DDR3L-1333 | -H9 | 1.5 | 9 | 13.5 (13.125)* | 13.5 (13.125)* | 36 | 49.5 (49.125)* | 9-9-9 |

*SK hynix DRAM devices support optional downbinning to CL7. SPD setting is programmed to match.

Speed Grade

| Grade | Frequency [MHz] | | | | | Remark |
|-------|-----------------|------|------|------|------|--------|
| | CL6 | CL7 | CL8 | CL9 | CL10 | |
| -G7 | 800 | 1066 | 1066 | | | |
| -H9 | 800 | 1066 | 1066 | 1333 | 1333 | |

Address Table

| | 4GB(1Rx8) | 8GB(1Rx4) | 8GB(2Rx8) | 16GB(2Rx4) | 16GB(4Rx8) |
|----------------|-----------|------------|-----------|------------|------------|
| Refresh Method | 8K/64ms | 8K/64ms | 8K/64ms | 8K/64ms | 8K/64ms |
| Row Address | A0-A15 | A0-A15 | A0-A15 | A0-A15 | A0-A15 |
| Column Address | A0-A9 | A0-A9, A11 | A0-A9 | A0-A9, A11 | A0-A9 |
| Bank Address | BA0-BA2 | BA0-BA2 | BA0-BA2 | BA0-BA2 | BA0-BA2 |
| Page Size | 1KB | 1KB | 1KB | 1KB | 1KB |

Pin Descriptions

| Pin Name | Description | Number | Pin Name | Description | Number |
|------------------------------|--|--------|---|--|--------|
| CK0 | Clock Input, positive line | 1 | ODT[1:0] | On Die Termination Inputs | 2 |
| $\overline{\text{CK0}}$ | Clock Input, negative line | 1 | DQ[63:0] | Data Input/Output | 64 |
| CK1 | Clock Input, positive line | 1 | CB[7:0] | Data check bits Input/Output | 8 |
| $\overline{\text{CK1}}$ | Clock Input, negative line | 1 | DQS[8:0] | Data strobes | 9 |
| CKE[1:0] | Clock Enables | 2 | $\overline{\text{DQS}}[8:0]$ | Data strobes, negative line | 9 |
| $\overline{\text{RAS}}$ | Row Address Strobe | 1 | DM[8:0]/ DQS[17:9], TDQS[17:9] | Data Masks / Data strobes, Termination data strobes | 9 |
| $\overline{\text{CAS}}$ | Column Address Strobe | 1 | $\overline{\text{DQS}}[17:9]$, $\overline{\text{TDQS}}[17:9]$ | Data strobes, negative line, Termination data strobes | 9 |
| $\overline{\text{WE}}$ | Write Enable | 1 | $\overline{\text{EVENT}}$ | Reserved for optional hardware temperature sensing | 1 |
| $\overline{\text{S}}[3:0]$ | Chip Selects | 4 | TEST | Memory bus test tool (Not Connected and Not Usable on DIMMs) | 1 |
| A[9:0],A11, A[15:13] | Address Inputs | 14 | $\overline{\text{RESET}}$ | Register and SDRAM control pin | 1 |
| A10/AP | Address Input/Autoprecharge | 1 | V _{DD} | Power Supply | 22 |
| A12/ $\overline{\text{BC}}$ | Address Input/Burst chop | 1 | V _{SS} | Ground | 59 |
| BA[2:0] | SDRAM Bank Addresses | 3 | V _{REFDQ} | Reference Voltage for DQ | 1 |
| SCL | Serial Presence Detect (SPD) Clock Input | 1 | V _{REFCA} | Reference Voltage for CA | 1 |
| SDA | SPD Data Input/Output | 1 | V _{TT} | Termination Voltage | 4 |
| SA[2:0] | SPD Address Inputs | 3 | V _{DDSPD} | SPD Power | 1 |
| Par_In | Parity bit for the Address and Control bus | 1 | | | |
| $\overline{\text{Err_Out}}$ | Parity error found on the Address and Control bus | 1 | | | |

Input/Output Functional Descriptions

| Symbol | Type | Polarity | Function |
|--|--------|---------------|--|
| CK0 | IN | Positive Line | Positive line of the differential pair of system clock inputs that drives input to the on-DIMM Clock Driver. |
| $\overline{\text{CK0}}$ | IN | Negative Line | Negative line of the differential pair of system clock inputs that drives the input to the on-DIMM Clock Driver. |
| CK1 | IN | Positive Line | Terminated but not used on RDIMMs. |
| $\overline{\text{CK1}}$ | IN | Negative Line | Terminated but not used on RDIMMs. |
| CKE[1:0] | IN | Active High | CKE HIGH activates, and CKE LOW deactivates internal clock signals, and device input buffers and output drivers of the SDRAMs. Taking CKE LOW provides PRECHARGE POWER-DOWN and SELF REFRESH operation (all banks idle), or ACTIVE POWER DOWN (row ACTIVE in any bank) |
| $\overline{\text{S}}[3:0]$ | IN | Active Low | Enables the command decoders for the associated rank of SDRAM when low and disables decoders when high. When decoders are disabled, new commands are ignored and previous operations continue. Other combinations of these input signals perform unique functions, including disabling all outputs (except CKE and ODT) of the register(s) on the DIMM or accessing internal control words in the register device(s). For modules with two registers, $\overline{\text{S}}[3:2]$ operate similarly to $\overline{\text{S}}[1:0]$ for the second set of register outputs or register control words. |
| ODT[1:0] | IN | Active High | On-Die Termination control signals |
| $\overline{\text{RAS}}$, $\overline{\text{CAS}}$, $\overline{\text{WE}}$ | IN | Active Low | When sampled at the positive rising edge of the clock, $\overline{\text{CAS}}$, $\overline{\text{RAS}}$, and $\overline{\text{WE}}$ define the operation to be executed by the SDRAM. |
| V_{REFDQ} | Supply | | Reference voltage for DQ0-DQ63 and CB0-CB7. |
| V_{REFCA} | Supply | | Reference voltage for A0-A15, BA0-BA2, $\overline{\text{RAS}}$, $\overline{\text{CAS}}$, $\overline{\text{WE}}$, $\overline{\text{S0}}$, $\overline{\text{S1}}$, CKE0, CKE1, Par_In, ODT0 and ODT1. |
| BA[2:0] | IN | — | Selects which SDRAM bank of eight is activated. BA0 - BA2 define to which bank an Active, Read, Write or Precharge command is being applied. Bank address also determines mode register is to be accessed during an MRS cycle. |
| A[15:13, 12/BC, 11, 10/AP, [9:0] | IN | — | Provided the row address for Active commands and the column address and Auto Precharge bit for Read/Write commands to select one location out of the memory array in the respective bank. A10 is sampled during a Precharge command to determine whether the Precharge applies to one bank (A10 LOW) or all banks (A10 HIGH). If only one bank is to be precharged, the bank is selected by BA. A12 is also utilized for BL 4/8 identification for "BL on the fly" during $\overline{\text{CAS}}$ command. The address inputs also provide the op-code during Mode Register Set commands. |
| DQ[63:0], CB[7:0] | I/O | — | Data and Check Bit Input/Output pins |
| DM[8:0] | IN | Active High | Masks write data when high, issued concurrently with input data. |
| V_{DD} , V_{SS} | Supply | | Power and ground for the DDR SDRAM input buffers and core logic. |
| V_{TT} | Supply | | Termination Voltage for Address/Command/Control/Clock nets. |

| Symbol | Type | Polarity | Function |
|--|---------------------|---------------|---|
| DQS[17:0] | I/O | Positive Edge | Positive line of the differential data strobe for input and output data. |
| $\overline{\text{DQS}}[17:0]$ | I/O | Negative Edge | Negative line of the differential data strobe for input and output data. |
| $\overline{\text{TDQS}}[17:9]$ TDQS[17:9] | OUT | | TDQS/ $\overline{\text{TDQS}}$ is applicable for X8 DRAMs only. When enabled via Mode Register A11=1 in MR1, DRAM will enable the same termination resistance function on TDQS/ $\overline{\text{TDQS}}$ that is applied to DQS/ $\overline{\text{DQS}}$. When disabled via mode register A11=0 in MR1, DM/TDQS will provide the data mask function and $\overline{\text{TDQS}}$ is not used. X4 DRAMs must disable the TDQS function via mode register A11=0 in MR1 |
| SA[2:0] | IN | — | These signals are tied at the system planar to either V_{SS} or V_{DDSPD} to configure the serial SPD EEPROM address range. |
| SDA | I/O | — | This bidirectional pin is used to transfer data into or out of the SPD EEPROM. A resistor must be connected from the SDA bus line to V_{DDSPD} on the system planar to act as a pullup. |
| SCL | IN | — | This signal is used to clock data into and out of the SPD EEPROM. A resistor may be connected from the SCL bus line to V_{DDSPD} on the system planar to act as a pullup. |
| $\overline{\text{EVENT}}$ | OUT (open drain) | Active Low | This signal indicates that a thermal event has been detected in the thermal sensing device. The system should guarantee the electrical level requirement is met for the $\overline{\text{EVENT}}$ pin on TS/SPD part. No pull-up resistor is provided on DIMM. |
| V_{DDSPD} | Supply | | Serial EEPROM positive power supply wired to a separate power pin at the connector which supports from 3.0 Volt to 3.6 Volt (nominal 3.3V) operation. |
| $\overline{\text{RESET}}$ | IN | | The $\overline{\text{RESET}}$ pin is connected to the $\overline{\text{RESET}}$ pin on the register and to the $\overline{\text{RESET}}$ pin on the DRAM. |
| Par_In | IN | | Parity bit for the Address and Control bus. ("1 ": Odd, "0 ": Even) |
| $\overline{\text{Err_Out}}$ | OUT (open drain) | | Parity error detected on the Address and Control bus. A resistor may be connected from $\overline{\text{Err_Out}}$ bus line to V_{DD} on the system planar to act as a pull up. |
| TEST | | | Used by memory bus analysis tools (unused (NC) on memory DIMMs) |

Pin Assignments

| Pin # | Front Side (left 1–60) | Pin # | Back Side (right 121–180) | Pin # | Front Side (left 61–120) | Pin # | Back Side (right 181–240) |
|-------|---------------------------|-------|---|-------|-----------------------------|-------|---|
| 1 | VREFDQ | 121 | Vss | 61 | A2 | 181 | A1 |
| 2 | Vss | 122 | DQ4 | 62 | VDD | 182 | VDD |
| 3 | DQ0 | 123 | DQ5 | 63 | NC, CK1 | 183 | VDD |
| 4 | DQ1 | 124 | Vss | 64 | NC, $\overline{\text{CK1}}$ | 184 | CK0 |
| 5 | Vss | 125 | DM0, DQS9, TDQS9 | 65 | VDD | 185 | $\overline{\text{CK0}}$ |
| 6 | $\overline{\text{DQS0}}$ | 126 | NC, $\overline{\text{DQS9}}$, $\overline{\text{TDQS9}}$ | 66 | VDD | 186 | VDD |
| 7 | DQS0 | 127 | Vss | 67 | VREFCA | 187 | $\overline{\text{EVENT}}$, NC |
| 8 | Vss | 128 | DQ6 | 68 | Par_In, NC | 188 | A0 |
| 9 | DQ2 | 129 | DQ7 | 69 | VDD | 189 | VDD |
| 10 | DQ3 | 130 | Vss | 70 | A10 / AP | 190 | BA1 |
| 11 | Vss | 131 | DQ12 | 71 | BA0 | 191 | VDD |
| 12 | DQ8 | 132 | DQ13 | 72 | VDD | 192 | $\overline{\text{RAS}}$ |
| 13 | DQ9 | 133 | Vss | 73 | $\overline{\text{WE}}$ | 193 | $\overline{\text{S0}}$ |
| 14 | Vss | 134 | DM1, DQS10, TDQS10 | 74 | $\overline{\text{CAS}}$ | 194 | VDD |
| 15 | $\overline{\text{DQS1}}$ | 135 | NC, $\overline{\text{DQS10}}$, $\overline{\text{TDQS10}}$ | 75 | VDD | 195 | ODT0 |
| 16 | DQS1 | 136 | Vss | 76 | $\overline{\text{S1}}$, NC | 196 | A13 |
| 17 | Vss | 137 | DQ14 | 77 | ODT1, NC | 197 | VDD |
| 18 | DQ10 | 138 | DQ15 | 78 | VDD | 198 | $\overline{\text{S3}}$, NC |
| 19 | DQ11 | 139 | Vss | 79 | $\overline{\text{S2}}$, NC | 199 | Vss |
| 20 | Vss | 140 | DQ20 | 80 | Vss | 200 | DQ36 |
| 21 | DQ16 | 141 | DQ21 | 81 | DQ32 | 201 | DQ37 |
| 22 | DQ17 | 142 | Vss | 82 | DQ33 | 202 | Vss |
| 23 | Vss | 143 | DM2, DQS11, TDQS11 | 83 | Vss | 203 | DM4, DQS13, TDQS13 |
| 24 | $\overline{\text{DQS2}}$ | 144 | NC, $\overline{\text{DQS11}}$, $\overline{\text{TDQS11}}$ | 84 | $\overline{\text{DQS4}}$ | 204 | NC, $\overline{\text{DQS13}}$, $\overline{\text{TDQS13}}$ |
| 25 | DQS2 | 145 | Vss | 85 | DQS4 | 205 | Vss |
| 26 | Vss | 146 | DQ22 | 86 | Vss | 206 | DQ38 |
| 27 | DQ18 | 147 | DQ23 | 87 | DQ34 | 207 | DQ39 |
| 28 | DQ19 | 148 | Vss | 88 | DQ35 | 208 | Vss |
| 29 | Vss | 149 | DQ28 | 89 | Vss | 209 | DQ44 |
| 30 | DQ24 | 150 | DQ29 | 90 | DQ40 | 210 | DQ45 |
| 31 | DQ25 | 151 | Vss | 91 | DQ41 | 211 | Vss |

NC = No Connect; RFU = Reserved Future Use

| Pin # | Front Side (left 1–60) | Pin # | Back Side (right 121–180) | Pin # | Front Side (left 61–120) | Pin # | Back Side (right 181–240) |
|------------|-----------------------------------|------------|---|-------|-----------------------------|-------|---|
| 32 | Vss | 152 | DM3,DQS12, TDQS12 | 92 | Vss | 212 | DM5,DQS14, TDQS14 |
| 33 | $\overline{\text{DQS3}}$ | 153 | NC, $\overline{\text{DQS12}}$, TDQS12 | 93 | $\overline{\text{DQS5}}$ | 213 | NC, $\overline{\text{DQS14}}$, TDQS14 |
| 34 | DQS3 | 154 | Vss | 94 | DQS5 | 214 | Vss |
| 35 | Vss | 155 | DQ30 | 95 | Vss | 215 | DQ46 |
| 36 | DQ26 | 156 | DQ31 | 96 | DQ42 | 216 | DQ47 |
| 37 | DQ27 | 157 | Vss | 97 | DQ43 | 217 | Vss |
| 38 | Vss | 158 | CB4, NC | 98 | Vss | 218 | DQ52 |
| 39 | CB0, NC | 159 | CB5, NC | 99 | DQ48 | 219 | DQ53 |
| 40 | CB1, NC | 160 | Vss | 100 | DQ49 | 220 | Vss |
| 41 | Vss | 161 | NC,DM8,DQS17, TDQS17 | 101 | Vss | 221 | DM6,DQS15, TDQS15 |
| 42 | $\overline{\text{DQS8}}$ | 162 | NC, $\overline{\text{DQS17}}$, TDQS17 | 102 | $\overline{\text{DQS6}}$ | 222 | NC, $\overline{\text{DQS15}}$, TDQS15 |
| 43 | DQS8 | 163 | Vss | 103 | DQS6 | 223 | Vss |
| 44 | Vss | 164 | CB6, NC | 104 | Vss | 224 | DQ54 |
| 45 | CB2, NC | 165 | CB7, NC | 105 | DQ50 | 225 | DQ55 |
| 46 | CB3, NC | 166 | Vss | 106 | DQ51 | 226 | Vss |
| 47 | Vss | 167 | NC(TEST) | 107 | Vss | 227 | DQ60 |
| 48 | VTT, NC | 168 | $\overline{\text{RESET}}$ | 108 | DQ56 | 228 | DQ61 |
| KEY | | KEY | | 109 | DQ57 | 229 | Vss |
| 49 | VTT, NC | 169 | CKE1, NC | 110 | Vss | 230 | DM7,DQS16, TDQS16 |
| 50 | CKE0 | 170 | VDD | 111 | $\overline{\text{DQS7}}$ | 231 | NC, $\overline{\text{DQS16}}$, TDQS16 |
| 51 | VDD | 171 | A15 | 112 | DQS7 | 232 | Vss |
| 52 | BA2 | 172 | A14 | 113 | Vss | 233 | DQ62 |
| 53 | $\overline{\text{Err_Out}}$, NC | 173 | VDD | 114 | DQ58 | 234 | DQ63 |
| 54 | VDD | 174 | A12 / $\overline{\text{BC}}$ | 115 | DQ59 | 235 | Vss |
| 55 | A11 | 175 | A9 | 116 | Vss | 236 | VDDSPD |
| 56 | A7 | 176 | VDD | 117 | SA0 | 237 | SA1 |
| 57 | VDD | 177 | A8 | 118 | SCL | 238 | SDA |
| 58 | A5 | 178 | A6 | 119 | SA2 | 239 | Vss |
| 59 | A4 | 179 | VDD | 120 | VTT | 240 | VTT |
| 60 | VDD | 180 | A3 | | | | |

NC = No Connect; RFU = Reserved Future Use

Registering Clock Driver Specifications

Capacitance Values

| Symbol | Parameter | Conditions | Min | Typ | Max | Unit |
|----------|--|--|-----|-----|-----|------|
| C_I | Input capacitance, Data inputs | | 1.5 | - | 2.5 | pF |
| | Input capacitance, CK, \overline{CK} , FBIN, \overline{FBIN} | | 2 | - | 3 | pF |
| | Input capacitance, CK, \overline{CK} , FBIN, \overline{FBIN} (DDR3-1600) | | 1.5 | - | 2.5 | pF |
| C_{IR} | Input capacitance, \overline{RESET} , MIRROR, QCSN | $V_I = V_{DD}$ or GND; $V_{DD} = 1.5V$ | - | - | 3 | pF |

Input & Output Timing Requirements

| Symbol | Parameter | Conditions | DDR3-800 1066/1333 | | Unit |
|-------------|---|---|------------------------|-----|------|
| | | | Min | Max | |
| f_{clock} | Input clock frequency | Application frequency | 300 | 670 | Mhz |
| f_{TEST} | Input clock frequency | Test frequency | 70 | 300 | Mhz |
| t_{SU} | Setup time | Input valid before $\overline{CK}/\overline{CK}$ | 100 | - | ps |
| t_H | Hold time | Input to remain valid after $\overline{CK}/\overline{CK}$ | 175 | - | ps |
| t_{PDM} | Propagation delay, single-bit switching | $\overline{CK}/\overline{CK}$ to output | 0.65 | 1.0 | ns |
| t_{DIS} | Output disable time (1/2-Clock prelaunch) | Y_n/\overline{Y}_n to output float | $0.5 + t_{QSK1}(\min)$ | - | ps |
| t_{EN} | Output enable time (1/2-Clock prelaunch) | Output driving to Y_n/\overline{Y}_n | $0.5 - t_{QSK1}(\max)$ | - | ps |

On DIMM Thermal Sensor

The DDR3 SDRAM DIMM temperature is monitored by integrated thermal sensor. The integrated thermal sensor comply with JEDEC "TSE2002av, Serial Presence Detect with Temperature Sensor".

Connection of Thermal Sensor

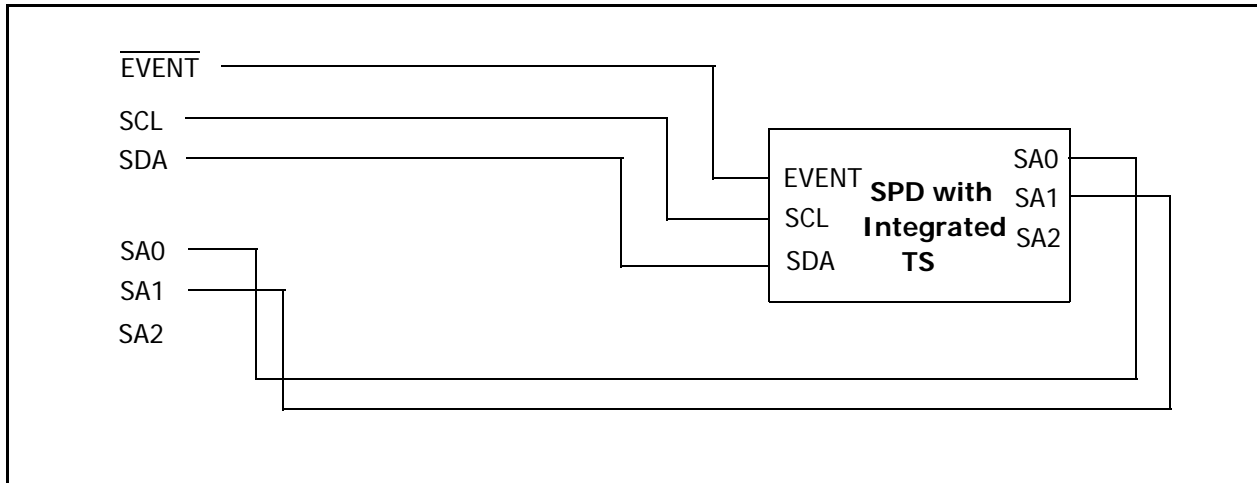

Temperature-to-Digital Conversion Performance

| Parameter | Condition | Min | Typ | Max | Unit |
|---------------------------------------|--|-----|-----------|-----------|--------------------|
| Temperature Sensor Accuracy (Grade B) | Active Range, $75^{\circ}\text{C} < T_A < 95^{\circ}\text{C}$ | - | ± 0.5 | ± 1.0 | $^{\circ}\text{C}$ |
| | Monitor Range, $40^{\circ}\text{C} < T_A < 125^{\circ}\text{C}$ | - | ± 1.0 | ± 2.0 | $^{\circ}\text{C}$ |
| | $-20^{\circ}\text{C} < T_A < 125^{\circ}\text{C}$ | - | ± 2.0 | ± 3.0 | $^{\circ}\text{C}$ |
| Resolution | | | 0.25 | | $^{\circ}\text{C}$ |

Functional Block Diagram

4GB, 512Mx72 Module(1Rank of x8)

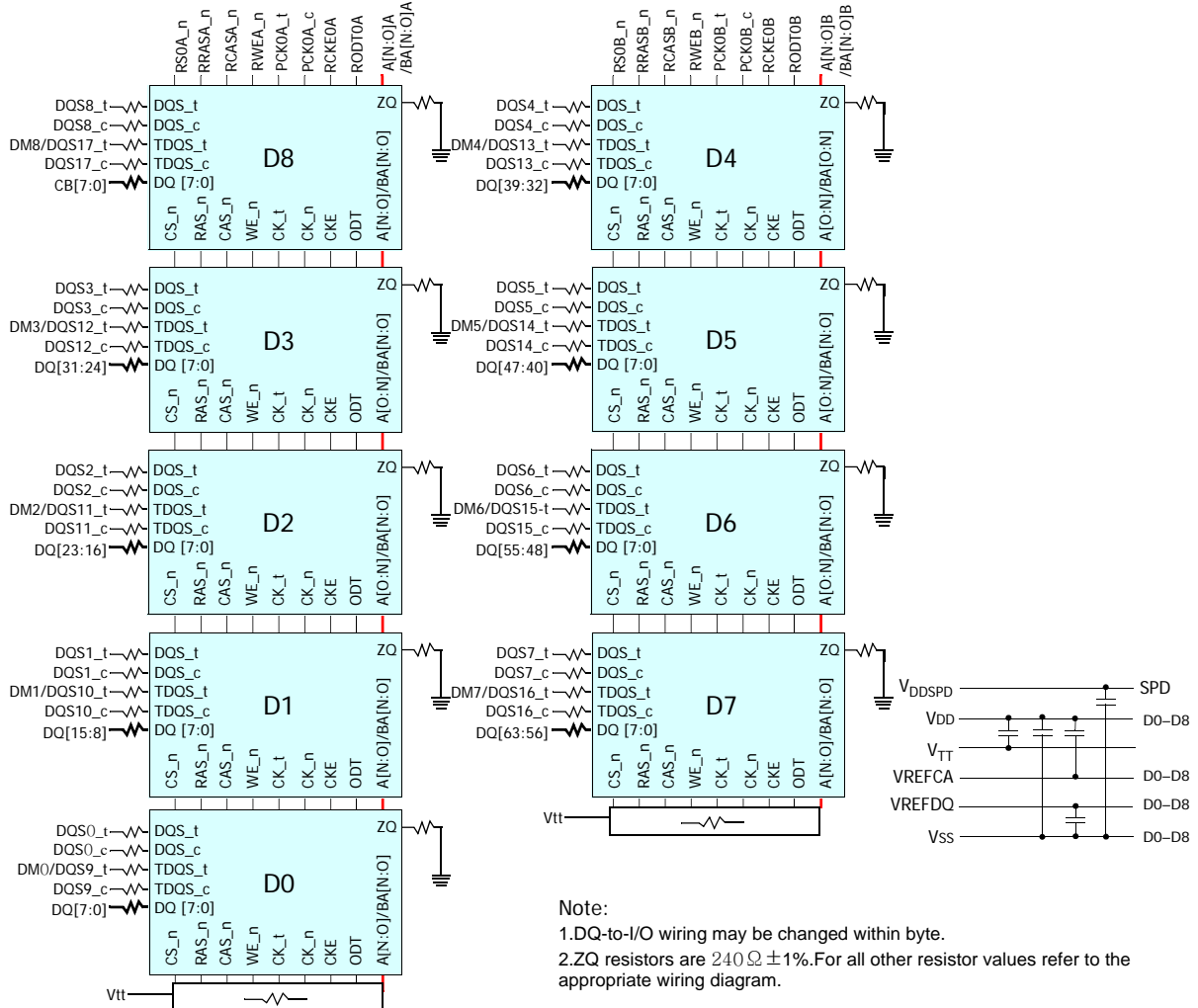

Note:
 1. DQ-to-I/O wiring may be changed within byte.
 2. ZQ resistors are 240Ω ± 1%. For all other resistor values refer to the appropriate wiring diagram.

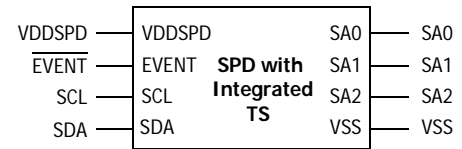
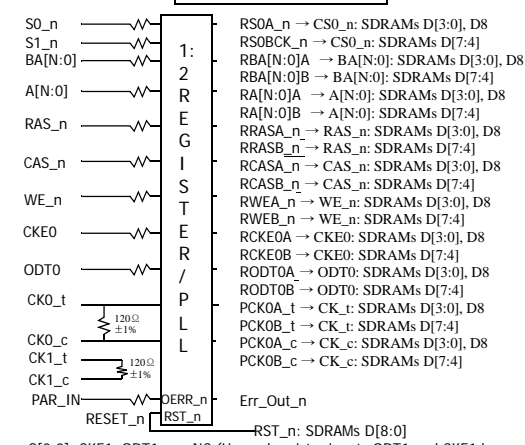

Plan to use SPD with Integrated TS of Class B and might be changed on customer's requests. For more details of SPD and Thermal sensor, please contact local SK hynix sales representative

S[3:2], CKE1, ODT1, are NC (Unused register inputs ODT1 and CKE1 have a 120...330Ω resistor to ground)

8GB, 1Gx72 Module(1Rank of x4) - page1

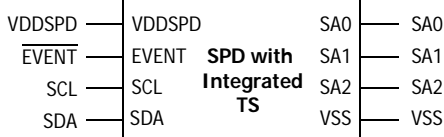
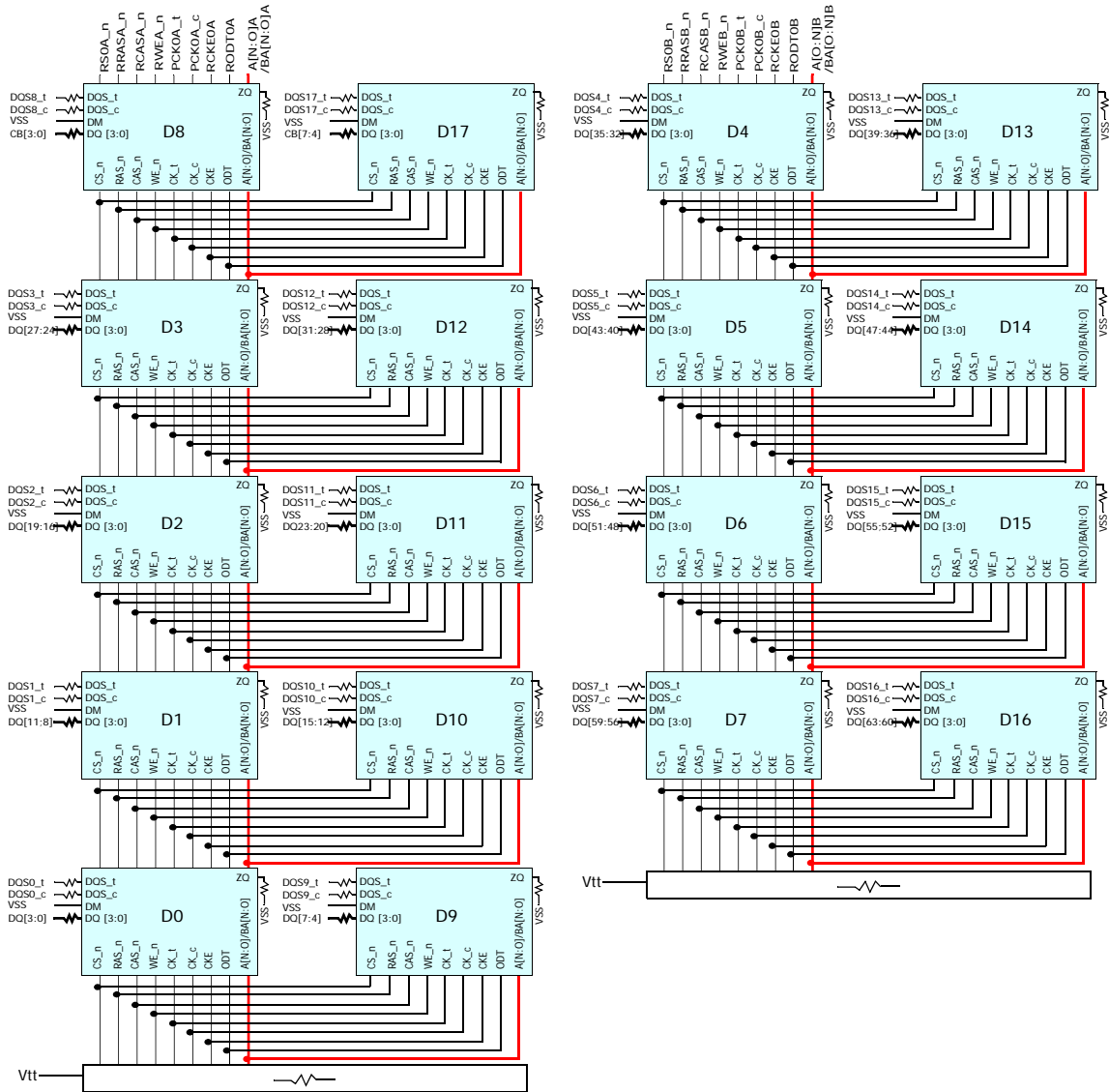

Plan to use SPD with Integrated TS of Class B and might be changed on customer's requests. For more details of SPD and Thermal sensor, please contact local SK hynix sales representative

Note:

1. DQ-to-I/O wiring may be changed within a nibble.
2. Unless otherwise noted, resistor values are $1\Omega \pm 5\%$.
3. See the wiring diagrams for all resistors associated with the command, address and control bus.
4. ZQ resistors are $240\Omega \pm 1\%$. For all other resistor values refer to the appropriate wiring diagram.

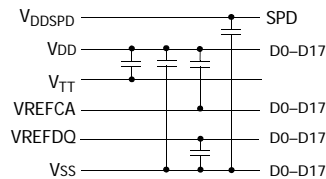

8GB, 1Gx72 Module(1Rank of x4) - page2

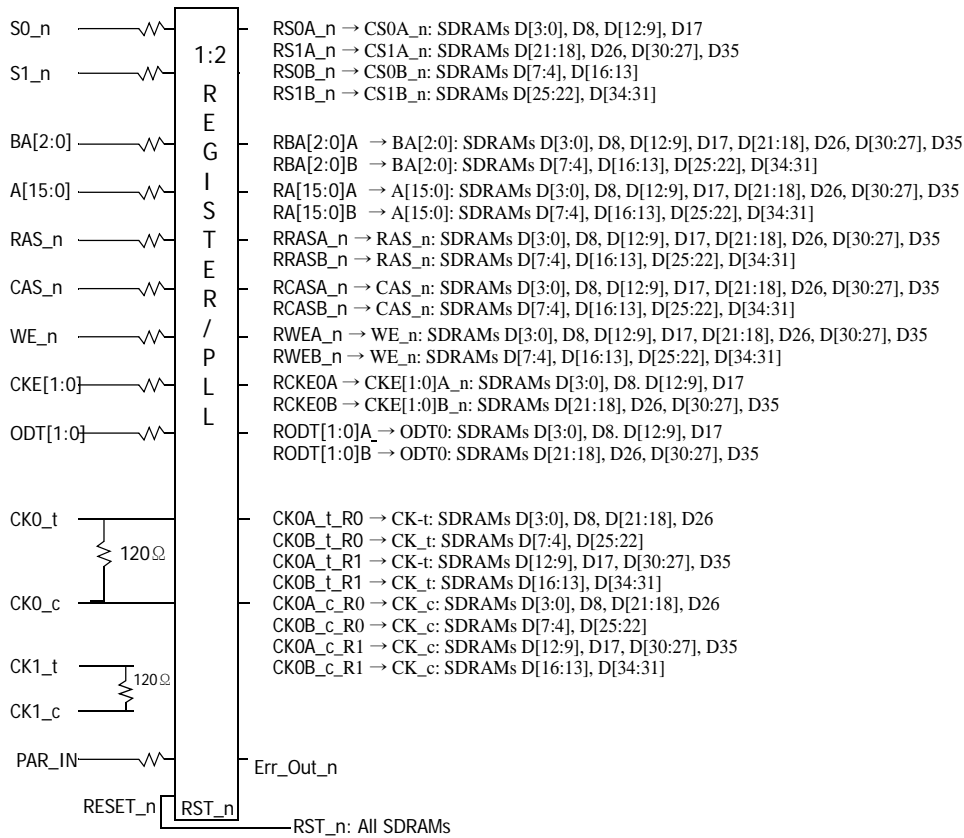

* S[3:2]_n are NC (Note: Otherwise stated differently all resistors values on this base are 22Ω±5%)

8GB, 1Gx72 Module(2Rank of x8) - page1

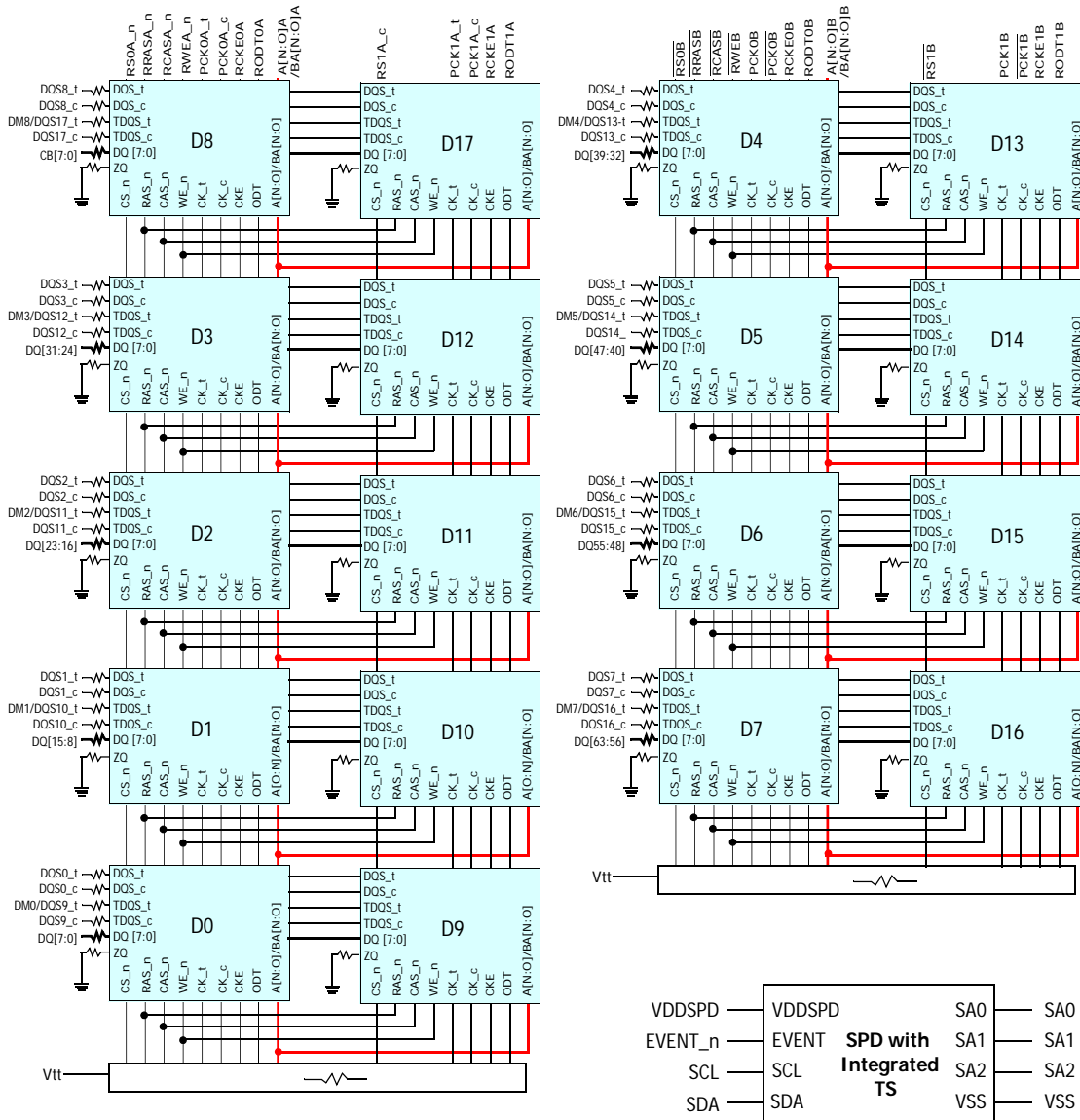

Note:

1. DQ-to-I/O wiring may be changed within a byte.
2. Unless otherwise noted, resistor values are $15\Omega \pm 5\%$.
3. ZQ resistors are $240\Omega \pm 1\%$. For all other resistor values refer to the appropriate wiring diagram.
4. See the wiring diagrams for all resistors associated with the command, address and control bus.

Plan to use SPD with Integrated TS of Class B and might be changed on customer's requests. For more details of SPD and Thermal sensor, please contact local SK hynix sales representative

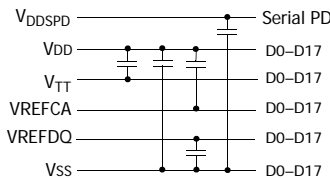

8GB, 1Gx72 Module(2Rank of x8) - page2

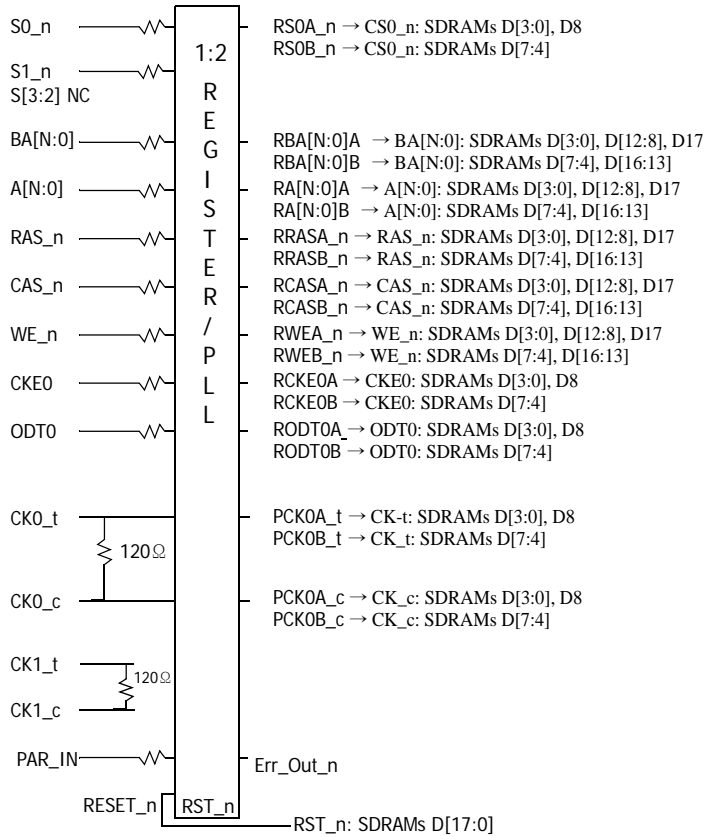

16GB, 2Gx72 Module(2Rank of x4) - page 1

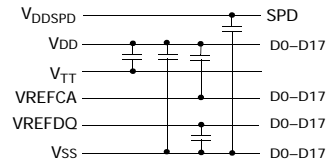
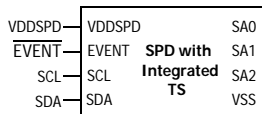

Plan to use SPD with Integrated TS of Class B and might be changed on customer's requests. For more details of SPD and Thermal sensor, please contact local SK SK hynix sales representative

Note:

1. DQ-to-I/O wiring may be changed within a nibble.
2. ZQ pins of each SDRAM are connected to individual RZQ resistors (240+/-1%) ohms.

16GB, 2Gx72 Module(2Rank of x4) - page2

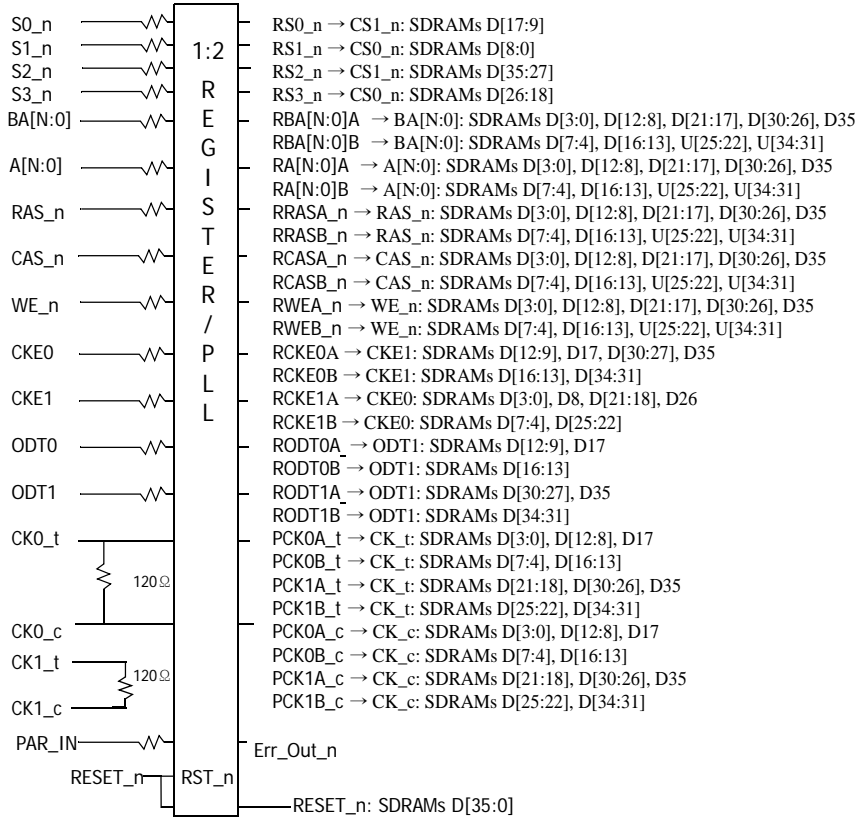

16GB, 2Gx72 Module(4Rank of x8) - page1

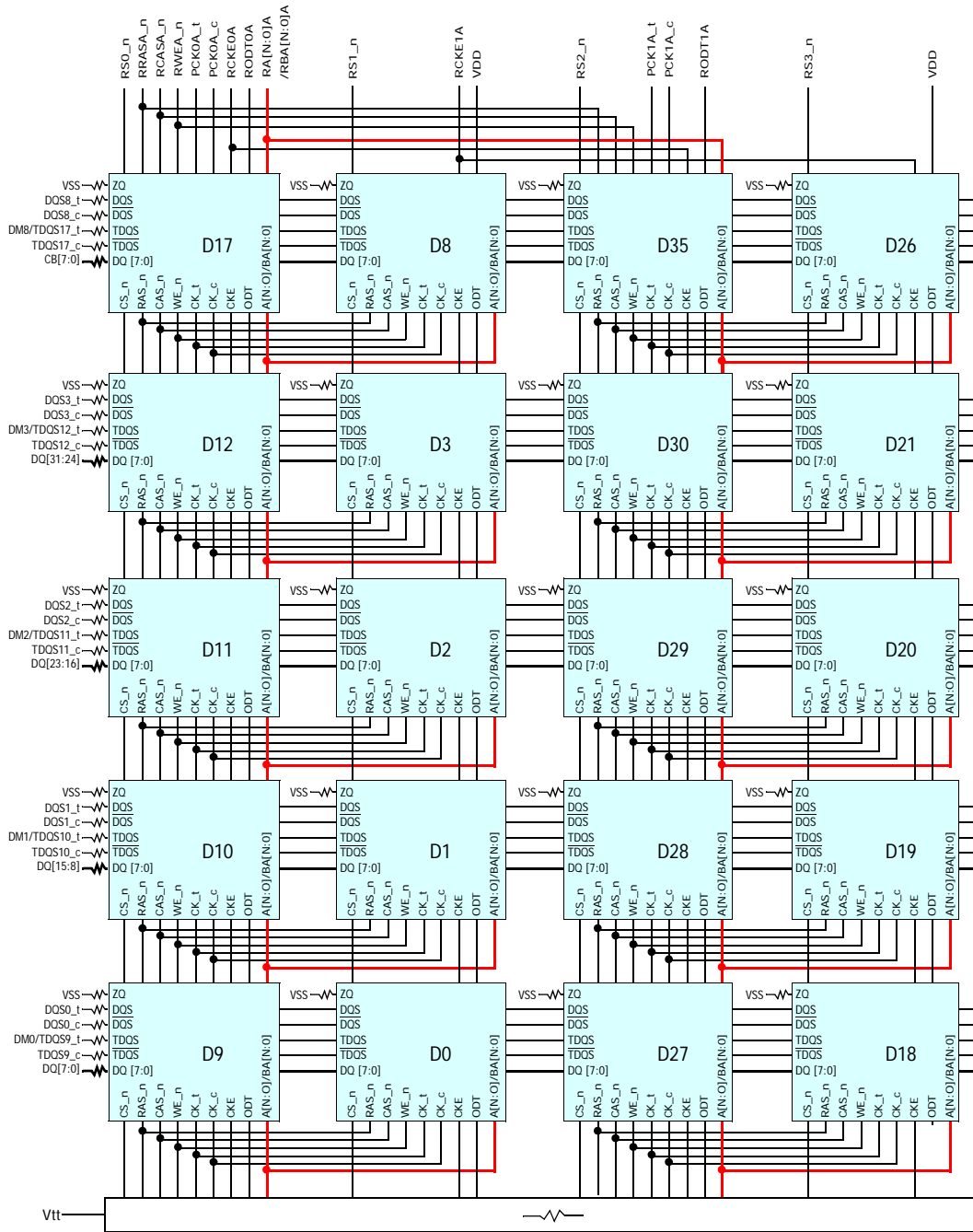

16GB, 2Gx72 Module(4Rank of x8) - page2

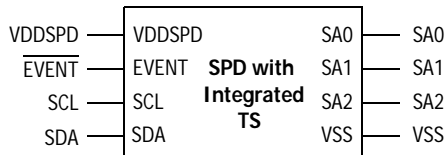
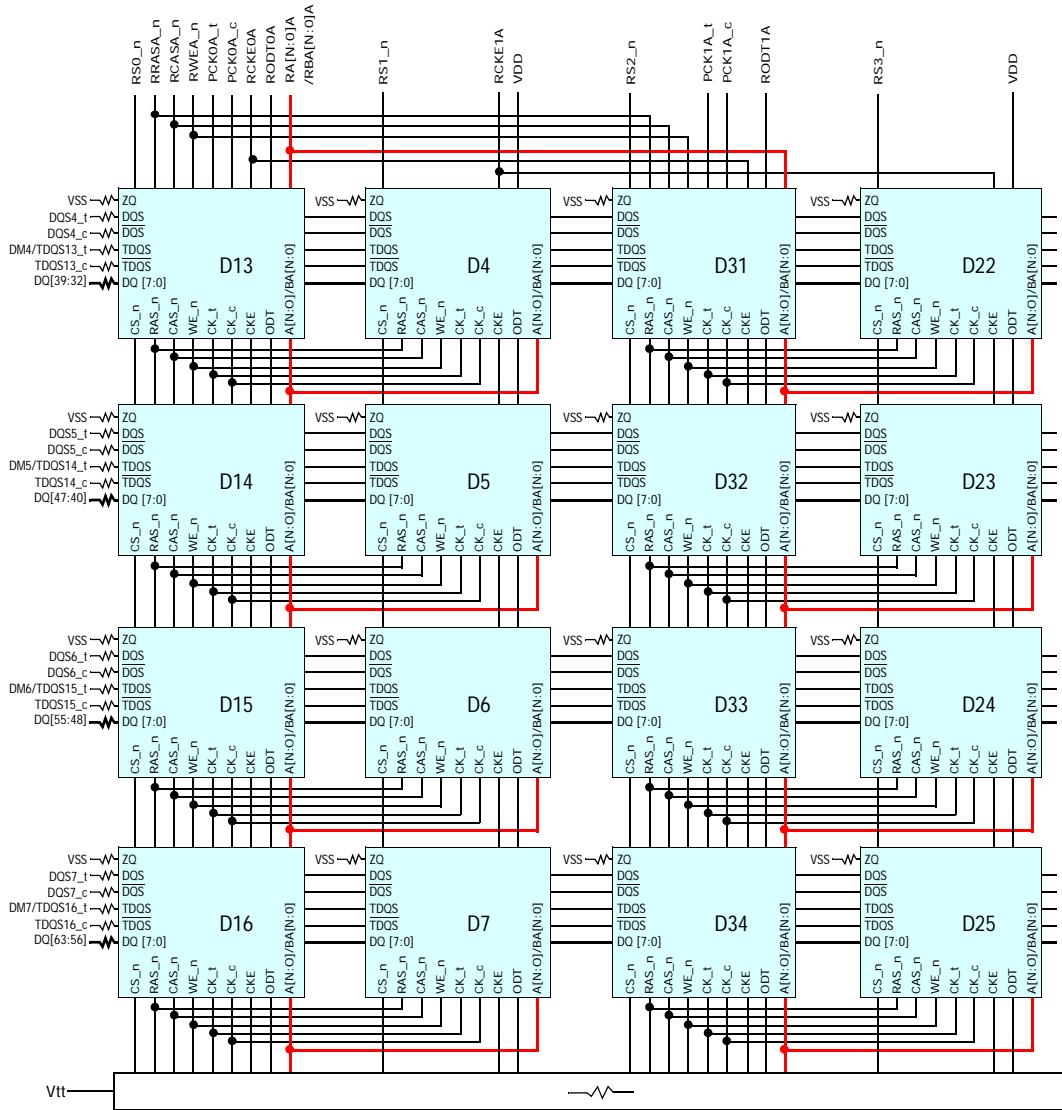

Plan to use SPD with Integrated TS of Class B and might be changed on customer's requests. For more details of SPD and Thermal sensor, please contact local SK hynix sales representative

Note:

1. DQ-to-I/O wiring may be changed within a nibble.
2. Unless otherwise noted, resistor values are $1\Omega \pm 5\%$.
3. See the wiring diagrams for all resistors associated with the command, address and control bus.
4. ZQ resistors are $240\Omega \pm 1\%$. For all other resistor values refer to the appropriate wiring diagram.

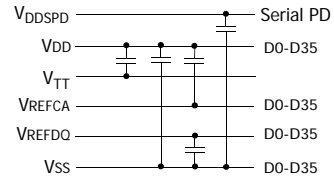

16GB, 2Gx72 Module(4Rank of x8) - page3

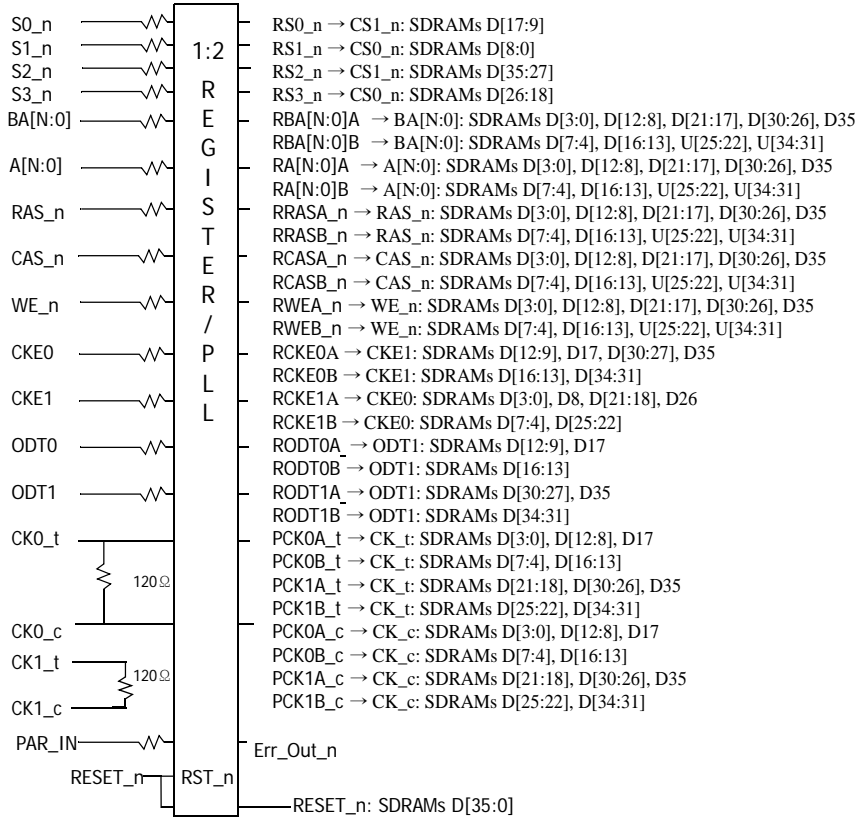

Absolute Maximum Ratings

Absolute Maximum DC Ratings

Absolute Maximum DC Ratings

| Symbol | Parameter | Rating | Units | Notes |
|------------------------------------|-------------------------------------|------------------|-------|-------|
| VDD | Voltage on VDD pin relative to Vss | - 0.4 V ~ 1.80 V | V | 1,3 |
| VDDQ | Voltage on VDDQ pin relative to Vss | - 0.4 V ~ 1.80 V | V | 1,3 |
| V _{IN} , V _{OUT} | Voltage on any pin relative to Vss | - 0.4 V ~ 1.80 V | V | 1 |
| T _{STG} | Storage Temperature | -55 to +100 | °C | 1, 2 |

Notes:

1. Stresses greater than those listed under "Absolute Maximum Ratings" may cause permanent damage to the device. This is a stress rating only and functional operation of the device at these or any other conditions above those indicated in the operational sections of this specification is not implied. Exposure to absolute maximum rating conditions for extended periods may affect reliability.
2. Storage Temperature is the case surface temperature on the center/top side of the DRAM. For the measurement conditions, please refer to JEDEC standard.
3. VDD and VDDQ must be within 300mV of each other at all times; and VREF must not be greater than 0.6XVDDQ, When VDD and VDDQ are less than 500mV; VREF may be equal to or less than 300mV.

DRAM Component Operating Temperature Range

Temperature Range

| Symbol | Parameter | Rating | Units | Notes |
|-------------------|------------------------------------|----------|-------|-------|
| T _{OPER} | Normal Operating Temperature Range | 0 to 85 | °C | 1,2 |
| | Extended Temperature Range | 85 to 95 | °C | 1,3 |

Notes:

1. Operating Temperature TOPER is the case surface temperature on the center / top side of the DRAM. For measurement conditions, please refer to the JEDEC document JESD51-2.
2. The Normal Temperature Range specifies the temperatures where all DRAM specifications will be supported. During operation, the DRAM case temperature must be maintained between 0 - 85°C under all operating conditions.
3. Some applications require operation of the DRAM in the Extended Temperature Range between 85°C and 95°C case temperature. Full specifications are guaranteed in this range, but the following additional conditions apply:
 - a. Refresh commands must be doubled in frequency, therefore reducing the Refresh interval tREFI to 3.9 μs. It is also possible to specify a component with 1X refresh (tREFI to 7.8μs) in the Extended Temperature Range. Please refer to the DIMM SPD for option availability
 - b. If Self-Refresh operation is required in the Extended Temperature Range, then it is mandatory to either use the Manual Self-Refresh mode with Extended Temperature Range capability (MR2 A6 = 0b and MR2 A7 = 1b) or enable the optional Auto Self-Refresh mode (MR2 A6 = 1b and MR2 A7 = 0b). DDR3 SDRAMs support Auto Self-Refresh and in Extended Temperature Range and please refer to component datasheet and/or the DIMM SPD for tREFI requirements in the Extended Temperature Range

AC & DC Operating Conditions

Recommended DC Operating Conditions

Recommended DC Operating Conditions - DDR3L (1.35V) operation

| Symbol | Parameter | Rating | | | Units | Notes |
|--------|---------------------------|--------|------|------|-------|---------|
| | | Min. | Typ. | Max. | | |
| VDD | Supply Voltage | 1.283 | 1.35 | 1.45 | V | 1,2,3,4 |
| VDDQ | Supply Voltage for Output | 1.283 | 1.35 | 1.45 | V | 1,2,3,4 |

Notes:

1. Maximum DC value may not be greater than 1.425V. The DC value is the linear average of VDD/VDDQ (t) over a very long period of time (e.g., 1 sec).
2. If maximum limit is exceeded, input levels shall be governed by DDR3 specifications.
3. Under these supply voltages, the device operates to this DDR3L specification.
4. Once initialized for DDR3L operation, DDR3 operation may only be used if the device is in reset while VDD and VDDQ are changed for DDR3 operation (see Figure 0).

Recommended DC Operating Conditions - - DDR3 (1.5V) operation

| Symbol | Parameter | Rating | | | Units | Notes |
|--------|---------------------------|--------|------|-------|-------|-------|
| | | Min. | Typ. | Max. | | |
| VDD | Supply Voltage | 1.425 | 1.5 | 1.575 | V | 1,2,3 |
| VDDQ | Supply Voltage for Output | 1.425 | 1.5 | 1.575 | V | 1,2,3 |

Notes:

1. If minimum limit is exceeded, input levels shall be governed by DDR3L specifications.
2. Under 1.5V operation, this DDR3L device operates to the DDR3 specifications under the same speed timings as defined for this device.
3. Once initialized for DDR3 operation, DDR3L operation may only be used if the device is in reset while VDD and VDDQ are changed for DDR3L operation (see Figure 0).

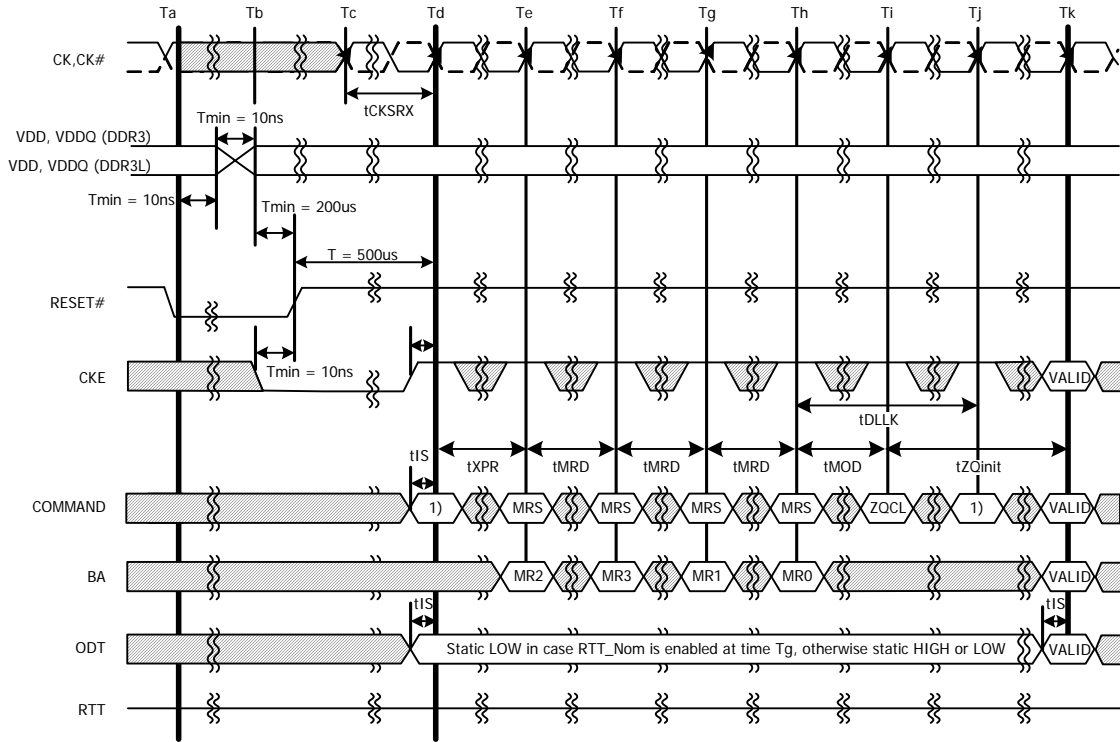

NOTE 1: From time point "Td" until "Tk" NOP or DES commands must be applied between MRS and ZQCL commands.

|| TIME BREAK ▨ DON'T CARE

Figure 0 - VDD/VDDQ Voltage Switch Between DDR3L and DDR3

AC & DC Input Measurement Levels

AC and DC Logic Input Levels for Single-Ended Signals

AC and DC Input Levels for Single-Ended Command and Address Signals

Single Ended AC and DC Input Levels for Command and Address

| Symbol | Parameter | DDR3L-800/1066 | | DDR3L-1333 | | Unit | Notes |
|-----------------|---------------------------------------|----------------|--------------|--------------|--------------|------|-------|
| | | Min | Max | Min | Max | | |
| VIH.CA(DC90) | DC input logic high | Vref + 0.09 | VDD | Vref + 0.09 | VDD | V | 1 |
| VIL.CA(DC90) | DC input logic low | VSS | Vref - 0.09 | VSS | Vref - 0.09 | V | 1 |
| VIH.CA(AC160) | AC input logic high | Vref + 0.160 | Note2 | Vref + 0.160 | Note2 | V | 1,2,5 |
| VIL.CA(AC160) | AC input logic low | Note2 | Vref - 0.160 | Note2 | Vref - 0.160 | V | 1,2,5 |
| VIH.CA(AC135) | AC Input logic high | Vref + 0.135 | Note2 | Vref + 0.135 | Note2 | V | 1,2,5 |
| VIL.CA(AC135) | AC input logic low | Note2 | Vref - 0.135 | Note2 | Vref - 0.135 | V | 1,2,5 |
| VIH.CA(AC125) | AC Input logic high | - | - | - | - | V | 1,2,5 |
| VIL.CA(AC125) | AC input logic low | - | - | - | - | V | 1,2,5 |
| $V_{RefCA(DC)}$ | Reference Voltage for ADD, CMD inputs | $0.49 * VDD$ | $0.51 * VDD$ | $0.49 * VDD$ | $0.51 * VDD$ | V | 3,4 |

Notes:

1. For input only pins except \overline{RESET} , Vref = VrefCA (DC).
2. Refer to "Overshoot and Undershoot Specifications" on page 38.
3. The ac peak noise on V_{Ref} may not allow V_{Ref} to deviate from $V_{RefCA(DC)}$ by more than +/-1% VDD (for reference: approx. +/- 13.5 mV).
4. For reference: approx. $VDD/2$ +/- 13.5 mV
5. These levels apply for 1.35 volt (see table above) operation only. If the device is operated at 1.5V (table "Single Ended AC and DC Input Levels for DQ and DM" on page 26), the respective levels in JESD79-3 (VIH/L.CA(DC100), VIH/L.CA(AC175), VIH/L.CA(AC150), VIH/L.CA(AC135), VIH/L.CA(AC125) etc.) apply. The 1.5V levels (VIH/L.CA(DC100), VIH/L.CA(AC175), VIH/L.CA(AC150), VIH/L.CA(AC135), VIH/L.CA(AC125) etc.) do not apply when the device is operated in the 1.35 voltage range.

AC and DC Input Levels for Single-Ended Signals

DDR3 SDRAM will support two V_{ih}/V_{il} AC levels for DDR3-800 and DDR3-1066s specified in table below. DDR3 SDRAM will also support corresponding tDS values (Table 43 and Table 51 in "DDR3L Device Operation") as well as derating tables Table 46 in "Device Operation" depending on V_{ih}/V_{il} AC levels.

Single Ended AC and DC Input Levels for DQ and DM

| Symbol | Parameter | DDR3L-800/1066 | | DDR3L-1333 | | Unit | Notes |
|--------------------|-------------------------------------|-------------------|-------------------|-------------------|-------------------|------|---------|
| | | Min | Max | Min | Max | | |
| $V_{IH.DQ}(DC90)$ | DC input logic high | $V_{ref} + 0.09$ | VDD | $V_{ref} + 0.09$ | VDD | V | 1 |
| $V_{IL.DQ}(DC90)$ | DC input logic low | VSS | $V_{ref} - 0.09$ | VSS | $V_{ref} - 0.09$ | V | 1 |
| $V_{IH.DQ}(AC160)$ | AC input logic high | $V_{ref} + 0.160$ | Note2 | - | - | V | 1, 2, 5 |
| $V_{IL.DQ}(AC160)$ | AC input logic low | Note2 | $V_{ref} - 0.160$ | - | - | V | 1, 2, 5 |
| $V_{IH.DQ}(AC135)$ | AC Input logic high | $V_{ref} + 0.135$ | Note2 | $V_{ref} + 0.135$ | Note2 | V | 1, 2, 5 |
| $V_{IL.DQ}(AC135)$ | AC input logic low | Note2 | $V_{ref} - 0.135$ | Note2 | $V_{ref} - 0.135$ | V | 1, 2, 5 |
| $V_{IH.DQ}(AC130)$ | AC Input logic high | - | - | - | - | V | 1, 2, 5 |
| $V_{IL.DQ}(AC130)$ | AC input logic low | - | - | - | - | V | 1, 2, 5 |
| $V_{RefDQ}(DC)$ | Reference Voltage for DQ, DM inputs | $0.49 * VDD$ | $0.51 * VDD$ | $0.49 * VDD$ | $0.51 * VDD$ | V | 3, 4 |

Notes:

1. $V_{ref} = V_{refDQ}(DC)$.
2. Refer to "Overshoot and Undershoot Specifications" on page 38.
3. The ac peak noise on V_{Ref} may not allow V_{Ref} to deviate from $V_{RefDQ}(DC)$ by more than +/-1% VDD (for reference: approx. +/- 13.5 mV).
4. For reference: approx. $VDD/2$ +/- 13.5 mV
5. These levels apply for 1.35 volt (table "Single Ended AC and DC Input Levels for Command and Address" on page 25) operation only. If the device is operated at 1.5V (table above), the respective levels in JESD79-3 ($V_{IH}/V_{IL.DQ}(DC100)$, $V_{IH}/V_{IL.DQ}(AC175)$, $V_{IH}/V_{IL.DQ}(AC150)$, $V_{IH}/V_{IL.DQ}(AC135)$ etc.) apply. The 1.5V levels ($V_{IH}/V_{IL.DQ}(DC100)$, $V_{IH}/V_{IL.DQ}(AC175)$, $V_{IH}/V_{IL.DQ}(AC150)$, $V_{IH}/V_{IL.DQ}(AC135)$ etc.) do not apply when the device is operated in the 1.35 voltage range.

Vref Tolerances

The dc-tolerance limits and ac-noise limits for the reference voltages V_{RefCA} and V_{RefDQ} are illustrated in figure below. It shows a valid reference voltage $V_{\text{Ref}}(t)$ as a function of time. (V_{Ref} stands for V_{RefCA} and V_{RefDQ} likewise).

$V_{\text{Ref}}(\text{DC})$ is the linear average of $V_{\text{Ref}}(t)$ over a very long period of time (e.g. 1 sec). This average has to meet the min/max requirements in the table "Differential Input Slew Rate Definition" on page 33. Furthermore $V_{\text{Ref}}(t)$ may temporarily deviate from $V_{\text{Ref}}(\text{DC})$ by no more than $\pm 1\% \text{ VDD}$.

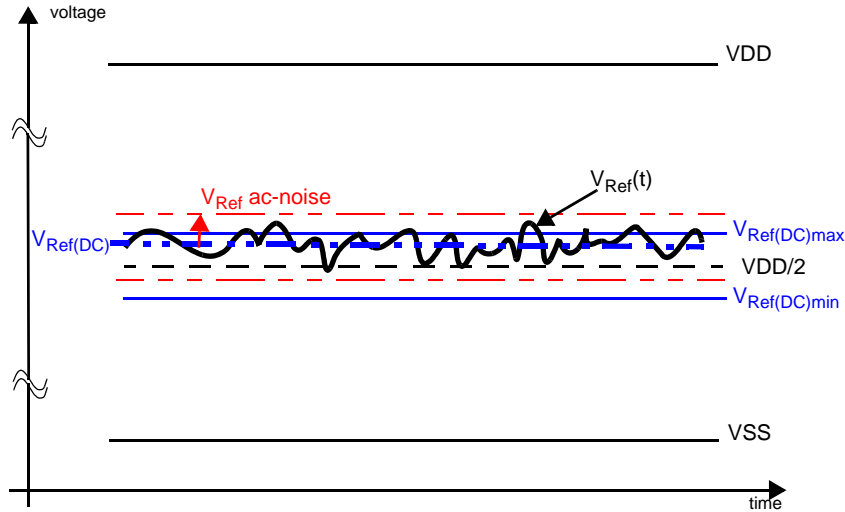

Illustration of $V_{\text{Ref}}(\text{DC})$ tolerance and V_{Ref} ac-noise limits

The voltage levels for setup and hold time measurements $V_{\text{IH}}(\text{AC})$, $V_{\text{IH}}(\text{DC})$, $V_{\text{IL}}(\text{AC})$, and $V_{\text{IL}}(\text{DC})$ are dependent on V_{Ref} .

" V_{Ref} " shall be understood as $V_{\text{Ref}}(\text{DC})$, as defined in figure above.

This clarifies that dc-variations of V_{Ref} affect the absolute voltage a signal has to reach to achieve a valid high or low level and therefore the time to which setup and hold is measured. System timing and voltage budgets need to account for $V_{\text{Ref}}(\text{DC})$ deviations from the optimum position within the data-eye of the input signals.

This also clarifies that the DRAM setup/hold specification and derating values need to include time and voltage associated with $V_{\text{Ref}}(\text{ac-noise})$. Timing and voltage effects due to ac-noise on V_{Ref} up to the specified limit ($\pm 1\% \text{ VDD}$) are included in DRAM timings and their associated deratings.

AC and DC Logic Input Levels for Differential Signals

Differential signal definition

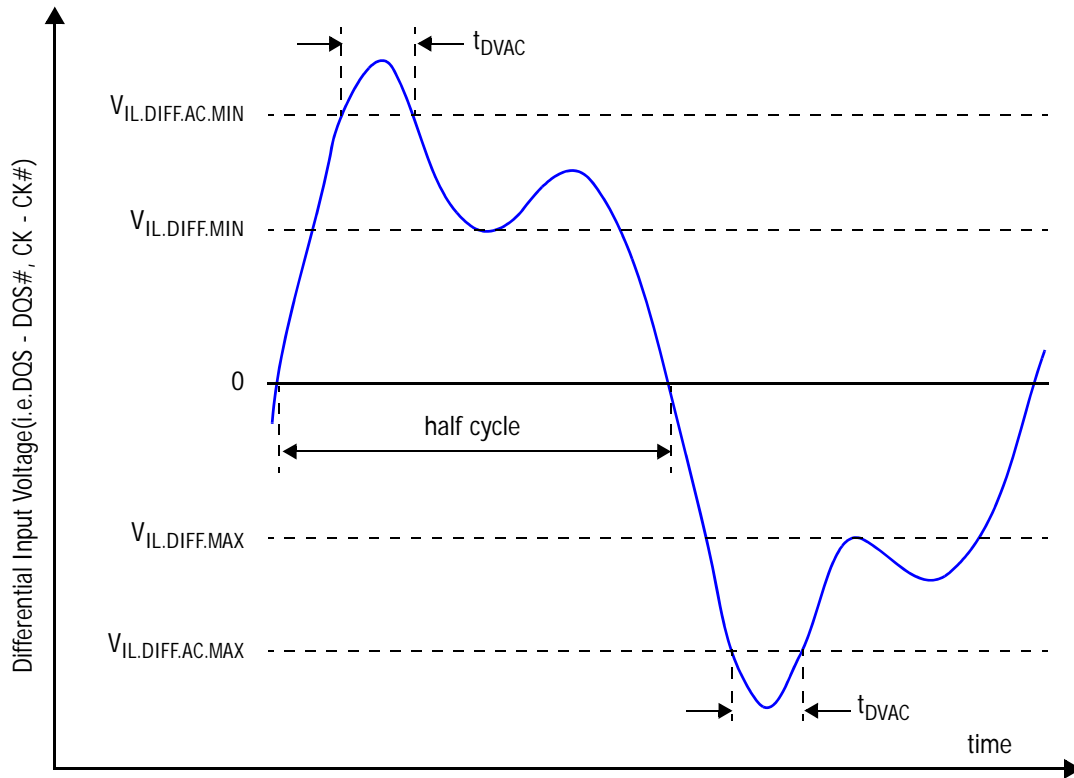

Definition of differential ac-swing and "time above ac-level" t_{DVAC}

Differential swing requirements for clock (CK - \overline{CK}) and strobe (DQS - \overline{DQS}) Differential AC and DC Input Levels

| Symbol | Parameter | DDR3L-800, 1066, 1333 | | Unit | Notes |
|--------------|------------------------------|-----------------------|-----------------------|------|-------|
| | | Min | Max | | |
| VIHdiff | Differential input high | + 0.180 | Note 3 | V | 1 |
| VILdiff | Differential input logic low | Note 3 | - 0.180 | V | 1 |
| VIHdiff (ac) | Differential input high ac | 2 x (VIH (ac) - Vref) | Note 3 | V | 2 |
| VILdiff (ac) | Differential input low ac | Note 3 | 2 x (VIL (ac) - Vref) | V | 2 |

Notes:

- Used to define a differential signal slew-rate.
- For CK - \overline{CK} use VIH/VIL (ac) of AADD/CMD and VREFCA; for DQS - \overline{DQS} , DQSL, \overline{DQSL} , DQSU, \overline{DQSU} use VIH/VIL (ac) of DQs and VREFDQ; if a reduced ac-high or ac-low levels is used for a signal group, then the reduced level applies also here.
- These values are not defined; however, the single-ended signals CK, \overline{CK} , DQS, \overline{DQS} , DQSL, \overline{DQSL} , DQSU, \overline{DQSU} need to be within the respective limits (VIH (dc) max, VIL (dc) min) for single-ended signals as well as the limitations for overshoot and undershoot. Refer to "Overshoot and Undershoot Specifications" on page 38.

Allowed time before ringback (tDVAC) for CK - \overline{CK} and DQS - \overline{DQS}

| Slew Rate [V/ns] | DDR3L-800/1066/1333 | | | |
|---------------------|--|-----|--|-----|
| | tDVAC [ps] @ VIH/Ldiff (ac) = 320mV | | tDVAC [ps] @ VIH/Ldiff (ac) = 270mV | |
| | min | max | min | max |
| > 4.0 | 189 | - | 201 | - |
| 4.0 | 189 | - | 201 | - |
| 3.0 | 162 | - | 179 | - |
| 2.0 | 109 | - | 134 | - |
| 1.8 | 91 | - | 119 | - |
| 1.6 | 69 | - | 100 | - |
| 1.4 | 40 | - | 76 | - |
| 1.2 | note | - | 44 | - |
| 1.0 | note | - | note | - |
| < 1.0 | note | - | note | - |

note : Rising input signal shall become equal to or greater than VIH(ac) level and Falling input signal shall become equal to or less than VIL(ac) level.

Single-ended requirements for differential signals

Each individual component of a differential signal (CK, DQS, DQSL, DQSU, $\overline{\text{CK}}$, $\overline{\text{DQS}}$, $\overline{\text{DQSL}}$, or $\overline{\text{DQSU}}$) has also to comply with certain requirements for single-ended signals.

CK and $\overline{\text{CK}}$ have to approximately reach VSEHmin / VSELmax (approximately equal to the ac-levels (VIH (ac) / VIL (ac)) for ADD/CMD signals) in every half-cycle.

DQS, DQSL, DQSU, $\overline{\text{DQS}}$, $\overline{\text{DQSL}}$ have to reach VSEHmin / VSELmax (approximately the ac-levels (VIH (ac) / VIL (ac)) for DQ signals) in every half-cycle preceding and following a valid transition.

Note that the applicable ac-levels for ADD/CMD and DQ's might be different per speed-bin etc. E.g., if VIH.CA(AC150)/VIL.CA(AC150) is used for ADD/CMD signals, then these ac-levels apply also for the single-ended signals CK and $\overline{\text{CK}}$.

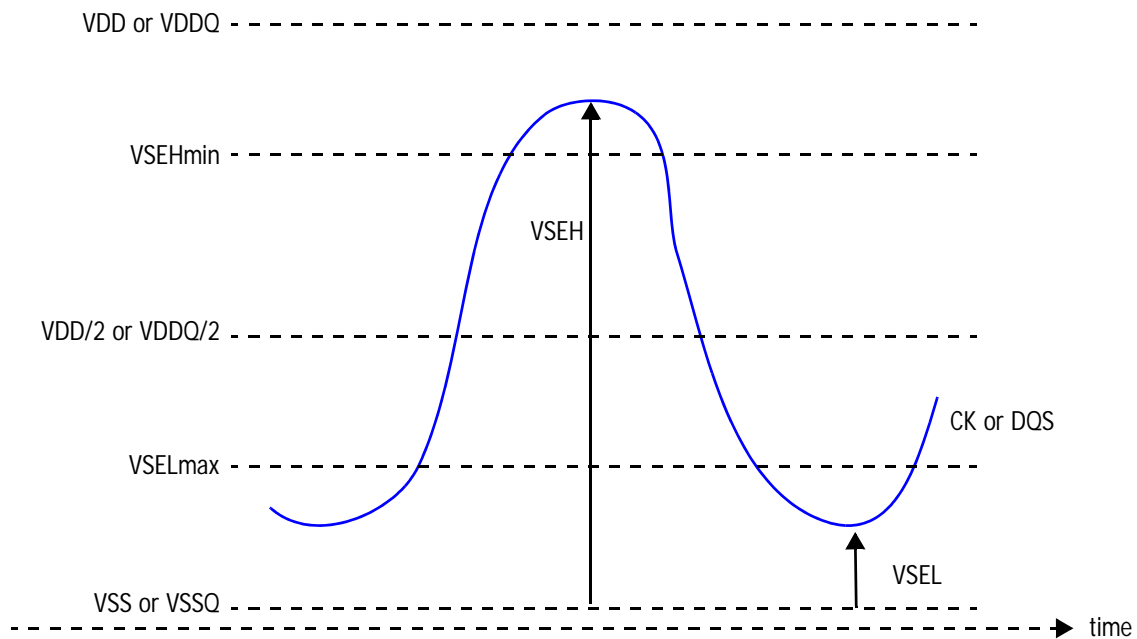

Single-ended requirements for differential signals.

Note that, while ADD/CMD and DQ signal requirements are with respect to Vref, the single-ended components of differential signals have a requirement with respect to $VDD / 2$; this is nominally the same. the transition of single-ended signals through the ac-levels is used to measure setup time. For single-ended components of differential signals the requirement to reach VSELmax, VSEHmin has no bearing on timing, but adds a restriction on the common mode characteristics of these signals.

Single-ended levels for CK, DQS, DQSL, DQSU, $\overline{\text{CK}}$, $\overline{\text{DQS}}$, $\overline{\text{DQSL}}$ or $\overline{\text{DQSU}}$

| Symbol | Parameter | DDR3L-800, 1066, 1333 | | Unit | Notes |
|--------|--|-----------------------|---------------------|------|-------|
| | | Min | Max | | |
| VSEH | Single-ended high level for strobes | $(VDD / 2) + 0.175$ | Note 3 | V | 1,2 |
| | Single-ended high level for Ck, $\overline{\text{CK}}$ | $(VDD / 2) + 0.175$ | Note 3 | V | 1,2 |
| VSEL | Single-ended low level for strobes | Note 3 | $(VDD / 2) - 0.175$ | V | 1,2 |
| | Single-ended low level for CK, $\overline{\text{CK}}$ | Note 3 | $(VDD / 2) - 0.175$ | V | 1,2 |

Notes:

1. For CK, $\overline{\text{CK}}$ use VIH/VIL (ac) of ADD/CMD; for strobes (DQS, $\overline{\text{DQS}}$, DQSL, $\overline{\text{DQSL}}$, DQSU, $\overline{\text{DQSU}}$) use VIH/VIL (ac) of DQs.
2. VIH (ac)/VIL (ac) for DQs is based on VREFDQ; VIH (ac)/VIL (ac) for ADD/CMD is based on VREFCA; if a reduced ac-high or ac-low level is used for a signal group, then the reduced level applies also here.
3. These values are not defined; however, the single-ended signals Ck, $\overline{\text{CK}}$, DQS, $\overline{\text{DQS}}$, DQSL, $\overline{\text{DQSL}}$, DQSU, $\overline{\text{DQSU}}$ need to be within the respective limits (VIH (dc) max, VIL (dc) min) for single-ended signals as well as the limitations for overshoot and undershoot. Refer to "Overshoot and Undershoot Specifications" on page 38.

Differential Input Cross Point Voltage

To guarantee tight setup and hold times as well as output skew parameters with respect to clock and strobe, each cross point voltage of differential input signals (CK, $\overline{\text{CK}}$ and DQS, $\overline{\text{DQS}}$) must meet the requirements in table below. The differential input cross point voltage V_{IX} is measured from the actual cross point of true and complement signals to the midlevel between of VDD and VSS

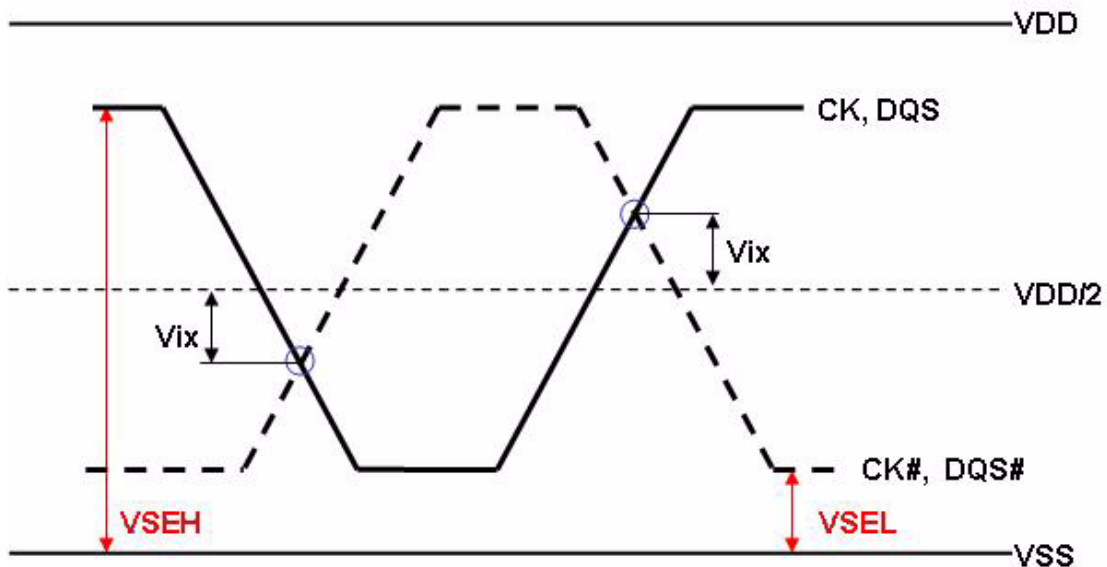

Vix Definition

Cross point voltage for differential input signals (CK, DQS)

| Symbol | Parameter | DDR3L-800, 1066, 1333 | | Unit | Notes |
|----------------------|---|-----------------------|-----|------|-------|
| | | Min | Max | | |
| $V_{IX}(\text{CK})$ | Differential Input Cross Point Voltage relative to VDD/2 for CK, $\overline{\text{CK}}$ | -150 | 150 | mV | 2 |
| | | -175 | 175 | mV | 1 |
| $V_{IX}(\text{DQS})$ | Differential Input Cross Point Voltage relative to VDD/2 for DQS, $\overline{\text{DQS}}$ | -150 | 150 | mV | 2 |

Notes:

1. Extended range for V_{IX} is only allowed for clock and if single-ended clock input signals CK and $\overline{\text{CK}}$ are monotonic with a single-ended swing VSEL / VSEH of at least VDD/2 +/- 250 mV, and when the differential slew rate of CK - $\overline{\text{CK}}$ is larger than 3 V/ns.

2. The relation between V_{IX} Min/Max and VSEL/VSEH should satisfy following.

$$(VDD/2) + V_{IX} (\text{Min}) - VSEL \geq 25\text{mV}$$

$$VSEH - ((VDD/2) + V_{IX} (\text{Max})) \geq 25\text{mV}$$

Slew Rate Definitions for Single-Ended Input Signals

See 7.5 “Address / Command Setup, Hold and Derating” on “DDR3L Device Operation” for single-ended slew rate definitions for address and command signals.

See 7.6 “Data Setup, Hold and Slew Rate Derating” on “DDR3L Device Operation” for single-ended slew rate definition for data signals.

Slew Rate Definitions for Differential Input Signals

Input slew rate for differential signals (\overline{CK} , \overline{CK} and \overline{DQS} , \overline{DQS}) are defined and measured as shown in table and figure below.

Differential Input Slew Rate Definition

| Description | Measured | | Defined by |
|---|-----------------|-----------------|--|
| | Min | Max | |
| Differential input slew rate for rising edge (\overline{CK} - \overline{CK} and \overline{DQS} - \overline{DQS}) | $V_{ILdiffmax}$ | $V_{IHdiffmin}$ | $[V_{IHdiffmin}-V_{ILdiffmax}] / \Delta TR_{diff}$ |
| Differential input slew rate for falling edge (\overline{CK} - \overline{CK} and \overline{DQS} - \overline{DQS}) | $V_{IHdiffmin}$ | $V_{ILdiffmax}$ | $[V_{IHdiffmin}-V_{ILdiffmax}] / \Delta TF_{diff}$ |

Notes:

The differential signal (i.e. \overline{CK} - \overline{CK} and \overline{DQS} - \overline{DQS}) must be linear between these thresholds.

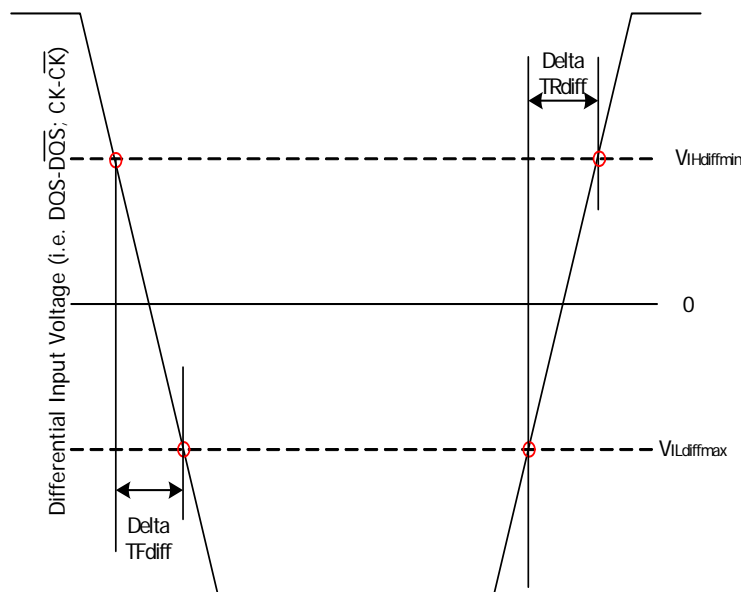

Differential Input Slew Rate Definition for \overline{DQS} , \overline{DQS} and \overline{CK} , \overline{CK}

AC & DC Output Measurement Levels

Single Ended AC and DC Output Levels

Table below shows the output levels used for measurements of single ended signals.

Single-ended AC and DC Output Levels

| Symbol | Parameter | DDR3L-800, 1066, | Unit | Notes |
|--------------|---|-------------------------------|------|-------|
| | | 1333 | | |
| $V_{OH(DC)}$ | DC output high measurement level (for IV curve linearity) | $0.8 \times V_{DDQ}$ | V | |
| $V_{OM(DC)}$ | DC output mid measurement level (for IV curve linearity) | $0.5 \times V_{DDQ}$ | V | |
| $V_{OL(DC)}$ | DC output low measurement level (for IV curve linearity) | $0.2 \times V_{DDQ}$ | V | |
| $V_{OH(AC)}$ | AC output high measurement level (for output SR) | $V_{TT} + 0.1 \times V_{DDQ}$ | V | 1 |
| $V_{OL(AC)}$ | AC output low measurement level (for output SR) | $V_{TT} - 0.1 \times V_{DDQ}$ | V | 1 |

Notes:

1. The swing of $\pm 0.1 \times V_{DDQ}$ is based on approximately 50% of the static single ended output high or low swing with a driver impedance of 40Ω and an effective test load of 25Ω to $V_{TT} = V_{DDQ} / 2$.

Differential AC and DC Output Levels

Table below shows the output levels used for measurements of single ended signals.

Differential AC and DC Output Levels

| Symbol | Parameter | DDR3L-800, 1066, | Unit | Notes |
|------------------|---|------------------------|------|-------|
| | | 1333 | | |
| $V_{OHdiff(AC)}$ | AC differential output high measurement level (for output SR) | $+ 0.2 \times V_{DDQ}$ | V | 1 |
| $V_{OLdiff(AC)}$ | AC differential output low measurement level (for output SR) | $- 0.2 \times V_{DDQ}$ | V | 1 |

Notes:

1. The swing of $\pm 0.2 \times V_{DDQ}$ is based on approximately 50% of the static differential output high or low swing with a driver impedance of 40Ω and an effective test load of 25Ω to $V_{TT} = V_{DDQ}/2$ at each of the differential outputs.

Single Ended Output Slew Rate

When the Reference load for timing measurements, output slew rate for falling and rising edges is defined and measured between $V_{OL(AC)}$ and $V_{OH(AC)}$ for single ended signals are shown in table and figure below.

Single-ended Output slew Rate Definition

| Description | Measured | | Defined by |
|--|--------------|--------------|--|
| | From | To | |
| Single-ended output slew rate for rising edge | $V_{OL(AC)}$ | $V_{OH(AC)}$ | $[V_{OH(AC)} - V_{OL(AC)}] / \Delta TR_{se}$ |
| Single-ended output slew rate for falling edge | $V_{OH(AC)}$ | $V_{OL(AC)}$ | $[V_{OH(AC)} - V_{OL(AC)}] / \Delta TF_{se}$ |

Notes:

- Output slew rate is verified by design and characterisation, and may not be subject to production test.

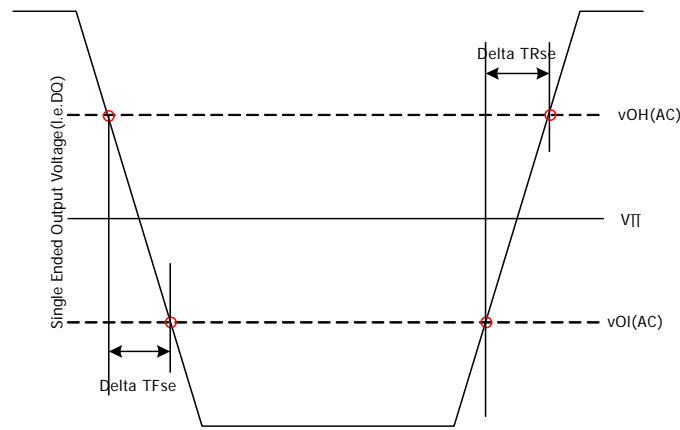

Single Ended Output Slew Rate Definition

Single Ended Output slew Rate Definition

Output Slew Rate (single-ended)

| | | DDR3L-800 | | DDR3L-1066 | | DDR3L-1333 | | Units |
|-------------------------------|--------|-----------|-----------------|------------|-----------------|------------|-----------------|-------|
| Parameter | Symbol | Min | Max | Min | Max | Min | Max | |
| Single-ended Output Slew Rate | SRQse | 1.75 | 5 ¹⁾ | 1.75 | 5 ¹⁾ | 1.75 | 5 ¹⁾ | V/ns |

Description: SR; Slew Rate

Q: Query Output (like in DQ, which stands for Data-in, Query-Output)

se: Single-ended Signals

For Ron = RZQ/7 setting

Note 1): In two cases, a maximum slew rate of 6V/ns applies for a single DQ signal within a byte lane.

Case 1 is a defined for a single DQ signal within a byte lane which is switching into a certain direction (either from high to low or low to high) while all remaining DQ signals in the same byte lane are static (i.e. they stay at either high or low).

Case 2 is a defined for a single DQ signal within a byte lane which is switching into a certain direction (either from high to low or low to high) while all remaining DQ signals in the same byte lane switching into the opposite direction (i.e. from low to high or high to low respectively). For the remaining DQ signal switching in to the opposite direction, the regular maximum limite of 5 V/ns applies.

Differential Output Slew Rate

With the reference load for timing measurements, output slew rate for falling and rising edges is defined and measured between VOLdiff (AC) and VOHdiff (AC) for differential signals as shown in table and figure below.

Differential Output Slew Rate Definition

| Description | Measured | | Defined by |
|--|--------------------------|--------------------------|--|
| | From | To | |
| Differential output slew rate for rising edge | V _{OLdiff} (AC) | V _{OHdiff} (AC) | $[V_{OHdiff} (AC) - V_{OLdiff} (AC)] / \Delta TR_{diff}$ |
| Differential output slew rate for falling edge | V _{OHdiff} (AC) | V _{OLdiff} (AC) | $[V_{OHdiff} (AC) - V_{OLdiff} (AC)] / \Delta TF_{diff}$ |

Notes:

- Output slew rate is verified by design and characterization, and may not be subject to production test.

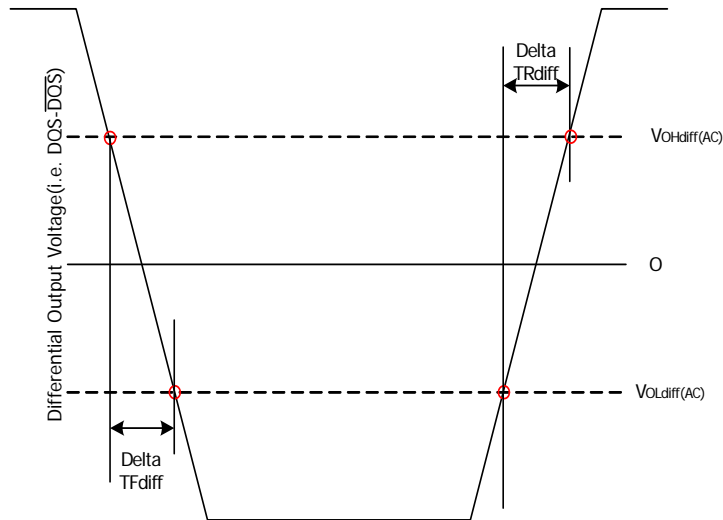

Differential Output slew Rate Definition

Differential Output Slew Rate

| | | DDR3L-800 | | DDR3L-1066 | | DDR3L-1333 | | Units |
|-------------------------------|---------|-----------|-----|------------|-----|------------|-----|-------|
| Parameter | Symbol | Min | Max | Min | Max | Min | Max | |
| Differential Output Slew Rate | SRQdiff | 3.5 | 12 | 3.5 | 12 | 3.5 | 12 | V/ns |

Description: SR; Slew Rate

Q: Query Output (like in DQ, which stands for Data-in, Query-Output)

se: Single-ended Signals

For Ron = RZQ/7 setting

Reference Load for AC Timing and Output Slew Rate

Figure below represents the effective reference load of 25 ohms used in defining the relevant AC timing parameters of the device as well as output slew rate measurements.

It is not intended as a precise representation of any particular system environment or a depiction of the actual load presented by a production tester. System designers should use IBIS or other simulation tools to correlate the timing reference load to a system environment. Manufacturers correlate to their production test conditions, generally one or more coaxial transmission lines terminated at the tester electronics.

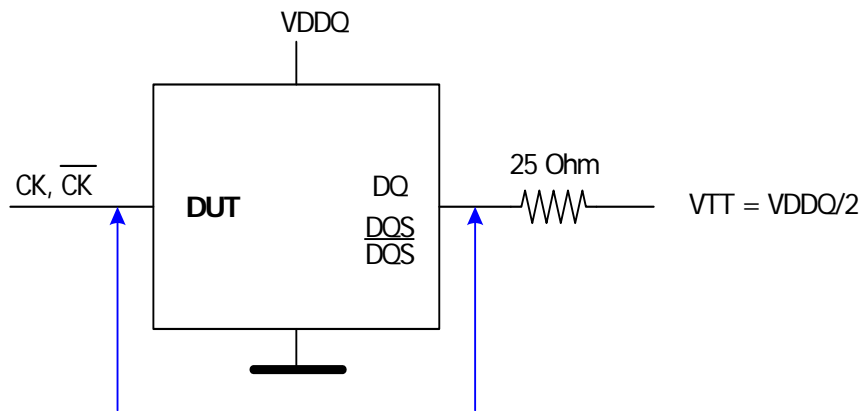

Reference Load for AC Timing and Output Slew Rate

Overshoot and Undershoot Specifications

Address and Control Overshoot and Undershoot Specifications

AC Overshoot/Undershoot Specification for Address and Control Pins

| Parameter | DDR3L-800 | DDR3L-1066 | DDR3L-1333 | Units |
|--|-----------|------------|------------|-------|
| Maximum peak amplitude allowed for overshoot area. (See Figure below) | 0.4 | 0.4 | 0.4 | V |
| Maximum peak amplitude allowed for undershoot area. (See Figure below) | 0.4 | 0.4 | 0.4 | V |
| Maximum overshoot area above VDD (See Figure below) | 0.67 | 0.5 | 0.4 | V-ns |
| Maximum undershoot area below VSS (See Figure below) | 0.67 | 0.5 | 0.4 | V-ns |

(A0-A15, BA0-BA3, CS, RAS, CAS, WE, CKE, ODT)

See figure below for each parameter definition

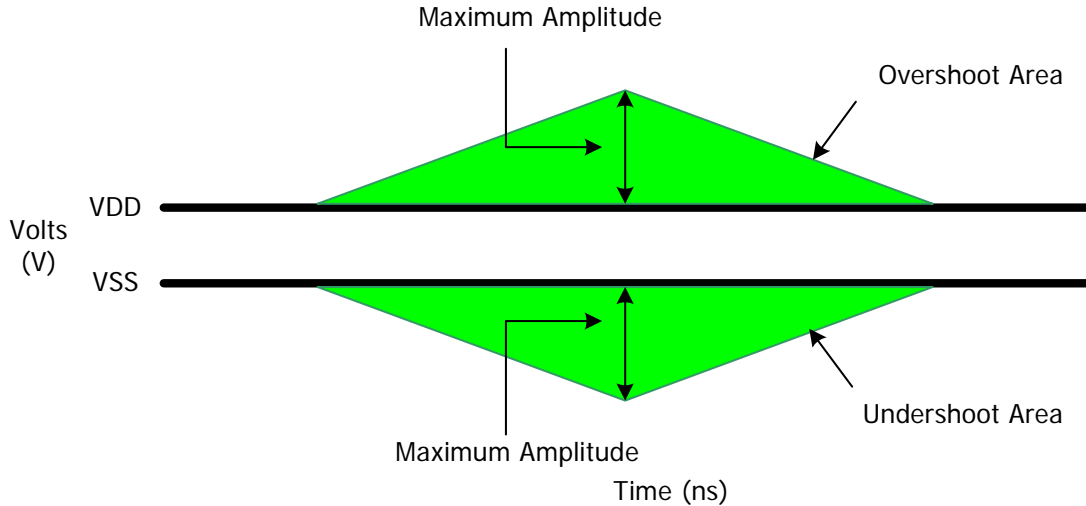

Address and Control Overshoot and Undershoot Definition

Clock, Data, Strobe and Mask Overshoot and Undershoot Specifications

AC Overshoot/Undershoot Specification for Clock, Data, Strobe and Mask

| Parameter | DDR3L-800 | DDR3L-1066 | DDR3L-1333 | Units |
|--|-----------|------------|------------|-------|
| Maximum peak amplitude allowed for overshoot area. (See Figure below) | 0.4 | 0.4 | 0.4 | V |
| Maximum peak amplitude allowed for undershoot area. (See Figure below) | 0.4 | 0.4 | 0.4 | V |
| Maximum overshoot area above VDD (See Figure below) | 0.25 | 0.19 | 0.15 | V-ns |
| Maximum undershoot area below VSS (See Figure below) | 0.25 | 0.19 | 0.15 | V-ns |

(CK, $\overline{\text{CK}}$, DQ, $\overline{\text{DQS}}$, $\overline{\text{DQS}}$, DM)

See figure below for each parameter definition

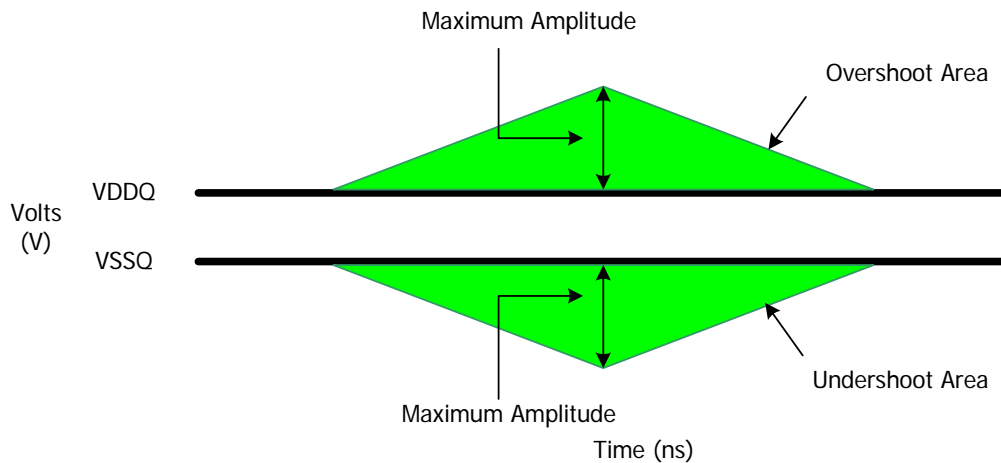

Clock, Data, Strobe and Mask Overshoot and Undershoot Definition

Refresh parameters by device density

Refresh parameters by device density

| Parameter | RTT_Nom Setting | 512Mb | 1Gb | 2Gb | 4Gb | 8Gb | Units | Notes |
|-------------------------------------|-----------------|--|-----|-----|-----|-----|-------|-------|
| REF command ACT or REF command time | tRFC | 90 | 110 | 160 | 260 | 350 | ns | |
| Average periodic refresh interval | tREFI | $0\text{ }^{\circ}\text{C} \leq T_{\text{CASE}} \leq 85\text{ }^{\circ}\text{C}$ | 7.8 | 7.8 | 7.8 | 7.8 | us | |
| | | $85\text{ }^{\circ}\text{C} < T_{\text{CASE}} \leq 95\text{ }^{\circ}\text{C}$ | 3.9 | 3.9 | 3.9 | 3.9 | us | 1 |

Standard Speed Bins

DDR3 SDRAM Standard Speed Bins include tCK, tRCD, tRP, tRAS and tRC for each corresponding bin.

DDR3L-800 Speed Bins

For specific Notes See "Speed Bin Table Notes" on page 44.

| Speed Bin | | | DDR3L-800E | | Unit | Notes |
|--|-----------|---------------|------------|-----|----------|------------|
| CL - nRCD - nRP | | | 6-6-6 | | | |
| Parameter | Symbol | min | max | | | |
| Internal read command to first data | t_{AA} | 15 | 20 | ns | | |
| ACT to internal read or write delay time | t_{RCD} | 15 | — | ns | | |
| PRE command period | t_{RP} | 15 | — | ns | | |
| ACT to ACT or REF command period | t_{RC} | 52.5 | — | ns | | |
| ACT to PRE command period | t_{RAS} | 37.5 | 9 * tREFI | ns | | |
| CL = 5 | CWL = 5 | $t_{CK(AVG)}$ | Reserved | | ns | 1, 2, 3, 4 |
| CL = 6 | CWL = 5 | $t_{CK(AVG)}$ | 2.5 | 3.3 | ns | 1, 2, 3 |
| Supported CL Settings | | | 6 | | n_{CK} | |
| Supported CWL Settings | | | 5 | | n_{CK} | |

DDR3L-1066 Speed Bins

For specific Notes See "Speed Bin Table Notes" on page 44.

| Speed Bin | | DDR3L-1066F | | Unit | Note | |
|--|-----------|---------------|-----------|----------|---------------|------------|
| CL - nRCD - nRP | | 7-7-7 | | | | |
| Parameter | Symbol | min | max | | | |
| Internal read command to first data | t_{AA} | 13.125 | 20 | ns | | |
| ACT to internal read or write delay time | t_{RCD} | 13.125 | — | ns | | |
| PRE command period | t_{RP} | 13.125 | — | ns | | |
| ACT to ACT or REF command period | t_{RC} | 50.625 | — | ns | | |
| ACT to PRE command period | t_{RAS} | 37.5 | 9 * tREFI | ns | | |
| CL = 5 | CWL = 5 | $t_{CK(AVG)}$ | Reserved | ns | 1, 2, 3, 4, 6 | |
| | CWL = 6 | $t_{CK(AVG)}$ | Reserved | ns | 4 | |
| CL = 6 | CWL = 5 | $t_{CK(AVG)}$ | 2.5 | 3.3 | ns | 1, 2, 3, 6 |
| | CWL = 6 | $t_{CK(AVG)}$ | Reserved | ns | 1, 2, 3, 4 | |
| CL = 7 | CWL = 5 | $t_{CK(AVG)}$ | Reserved | ns | 4 | |
| | CWL = 6 | $t_{CK(AVG)}$ | 1.875 | < 2.5 | ns | 1, 2, 3, 4 |
| CL = 8 | CWL = 5 | $t_{CK(AVG)}$ | Reserved | ns | 4 | |
| | CWL = 6 | $t_{CK(AVG)}$ | 1.875 | < 2.5 | ns | 1, 2, 3 |
| Supported CL Settings | | 6, 7, 8 | | n_{CK} | | |
| Supported CWL Settings | | 5, 6 | | n_{CK} | | |

DDR3L-1333 Speed Bins

For specific Notes See "Speed Bin Table Notes" on page 44.

| Speed Bin | | DDR3L-1333H | | Unit | Note | |
|--|---------------|----------------------------------|---------------------------|----------|---------------|---------------|
| CL - nRCD - nRP | | 9-9-9 | | | | |
| Parameter | Symbol | min | max | | | |
| Internal read command to first data | t_{AA} | 13.75 (13.125) ^{5,8} | 20 | ns | | |
| ACT to internal read or write delay time | t_{RCD} | 13.75 (13.125) ^{5,8} | — | ns | | |
| PRE command period | t_{RP} | 13.75 (13.125) ^{5,8} | — | ns | | |
| ACT to ACT or REF command period | t_{RC} | 48.75 (48.125) ^{5,8} | — | ns | | |
| ACT to PRE command period | t_{RAS} | 36 | 9 * tREFI | ns | | |
| CL = 5 | CWL = 5 | $t_{CK(AVG)}$ | Reserved | ns | 1, 2, 3, 4, 7 | |
| | CWL = 6, 7 | $t_{CK(AVG)}$ | Reserved | ns | 4 | |
| CL = 6 | CWL = 5 | $t_{CK(AVG)}$ | 2.5 | 3.3 | ns | 1, 2, 3, 7 |
| | CWL = 6 | $t_{CK(AVG)}$ | Reserved | Reserved | ns | 1, 2, 3, 4, 7 |
| | CWL = 7 | $t_{CK(AVG)}$ | Reserved | Reserved | ns | 4 |
| CL = 7 | CWL = 5 | $t_{CK(AVG)}$ | Reserved | Reserved | ns | 4 |
| | CWL = 6 | $t_{CK(AVG)}$ | 1.875 | < 2.5 | ns | 1, 2, 3, 4, 7 |
| | | | (Optional) ^{5,9} | | | |
| CWL = 7 | $t_{CK(AVG)}$ | Reserved | Reserved | ns | 1, 2, 3, 4 | |
| CL = 8 | CWL = 5 | $t_{CK(AVG)}$ | Reserved | Reserved | ns | 4 |
| | CWL = 6 | $t_{CK(AVG)}$ | 1.875 | < 2.5 | ns | 1, 2, 3, 7 |
| | CWL = 7 | $t_{CK(AVG)}$ | Reserved | Reserved | ns | 1, 2, 3, 4 |
| CL = 9 | CWL = 5, 6 | $t_{CK(AVG)}$ | Reserved | Reserved | ns | 4 |
| | CWL = 7 | $t_{CK(AVG)}$ | 1.5 | < 1.875 | ns | 1, 2, 3, 4 |
| CL = 10 | CWL = 5, 6 | $t_{CK(AVG)}$ | Reserved | Reserved | ns | 4 |
| | CWL = 7 | $t_{CK(AVG)}$ | 1.5 | < 1.875 | ns | 1, 2, 3 |
| | | | (Optional) | | ns | 5 |
| Supported CL Settings | | 6, (7), 8, 9, (10) | | t_{CK} | | |
| Supported CWL Settings | | 5, 6, 7 | | t_{CK} | | |

Speed Bin Table Notes

Absolute Specification (T_{OPER} ; $V_{DDQ} = V_{DD} = 1.35V + 1.000/- 0.067 V$);

Notes:

1. The CL setting and CWL setting result in tCK(AVG).MIN and tCK(AVG).MAX requirements. When making a selection of tCK(AVG), both need to be fulfilled: Requirements from CL setting as well as requirements from CWL setting.
2. tCK(AVG).MIN limits: Since CAS Latency is not purely analog - data and strobe output are synchronized by the DLL - all possible intermediate frequencies may not be guaranteed. An application should use the next smaller JEDEC standard tCK(AVG) value (3.0, 2.5, 1.875, 1.5, or 1.25 ns) when calculating CL [nCK] = tAA [ns] / tCK(AVG) [ns], rounding up to the next 'Supported CL', where tCK(AVG) = 3.0 ns should only be used for CL = 5 calculation.
3. tCK(AVG).MAX limits: Calculate tCK(AVG) = tAA.MAX / CL SELECTED and round the resulting tCK(AVG) down to the next valid speed bin (i.e. 3.3ns or 2.5ns or 1.875 ns or 1.25 ns). This result is tCK(AVG).MAX corresponding to CL SELECTED.
4. 'Reserved' settings are not allowed. User must program a different value.
5. 'Optional' settings allow certain devices in the industry to support this setting, however, it is not a mandatory feature. Refer to DIMM data sheet and/or the DIMM SPD information if and how this setting is supported.
6. Any DDR3-1066 speed bin also supports functional operation at lower frequencies as shown in the table which are not subject to Production Tests but verified by Design/Characterization.
7. Any DDR3-1333 speed bin also supports functional operation at lower frequencies as shown in the table which are not subject to Production Tests but verified by Design/Characterization.
8. DDR3 SDRAM devices supporting optional down binning to CL=7 and CL=9, and tAA/tRCD/tRP must be 13.125 ns or lower. SPD settings must be programmed to match. For example, DDR3-1333H devices supporting down binning to DDR3-1066F should program 13.125 ns in SPD bytes for tAAmin (Byte 16), tRCDmin (Byte 18), and tRPmin (Byte 20). DDR3-1600K devices supporting down binning to DDR3-1333H or DDR3-1600F should program 13.125 ns in SPD bytes for tAAmin (Byte 16), tRCDmin (Byte 18), and tRPmin (Byte 20). Once tRP (Byte 20) is programmed to 13.125ns, tRCmin (Byte 21,23) also should be programmed accordingly. For example, 49.125ns (tRASmin + tRPmin = 36 ns + 13.125 ns) for DDR3-1333H and 48.125ns (tRASmin + tRPmin = 35 ns + 13.125 ns) for DDR3-1600K.

Environmental Parameters

| Symbol | Parameter | Rating | Units | Notes |
|------------------|---|-------------|----------|-------|
| T _{OPR} | Operating temperature | See Note | | 3 |
| H _{OPR} | Operating humidity (relative) | 10 to 90 | % | 1 |
| T _{STG} | Storage temperature | -50 to +100 | °C | 1 |
| H _{STG} | Storage humidity (without condensation) | 5 to 95 | % | 1 |
| P _{BAR} | Barometric Pressure (operating & storage) | 105 to 69 | K Pascal | 1, 2 |

Note:

1. Stress greater than those listed may cause permanent damage to the device. This is a stress rating only, and device functional operation at or above the conditions indicated is not implied. Exposure to absolute maximum rating conditions for extended periods may affect reliability.
2. Up to 9850 ft.
3. The designer must meet the case temperature specifications for individual module components.

IDD and IDDQ Specification Parameters and Test Conditions

IDD and IDDQ Measurement Conditions

In this chapter, IDD and IDDQ measurement conditions such as test load and patterns are defined. Figure 1. shows the setup and test load for IDD and IDDQ measurements.

- IDD currents (such as IDD0, IDD1, IDD2N, IDD2NT, IDD2P0, IDD2P1, IDD2Q, IDD3N, IDD3P, IDD4R, IDD4W, IDD5B, IDD6, IDD6ET and IDD7) are measured as time-averaged currents with all VDD balls of the DDR3 SDRAM under test tied together. Any IDDQ current is not included in IDD currents.
- IDDQ currents (such as IDDQ2NT and IDDQ4R) are measured as time-averaged currents with all VDDQ balls of the DDR3 SDRAM under test tied together. Any IDD current is not included in IDDQ currents.

Attention: IDDQ values cannot be directly used to calculate IO power of the DDR3 SDRAM. They can be used to support correlation of simulated IO power to actual IO power as outlined in Figure 2. In DRAM module application, IDDQ cannot be measured separately since VDD and VDDQ are using one merged-power layer in Module PCB.

For IDD and IDDQ measurements, the following definitions apply:

- "0" and "LOW" is defined as $V_{IN} \leq V_{ILAC(max)}$.
- "1" and "HIGH" is defined as $V_{IN} \geq V_{IHAC(max)}$.
- "MID_LEVEL" is defined as inputs are $V_{REF} = V_{DD}/2$.
- Timing used for IDD and IDDQ Measurement-Loop Patterns are provided in Table 1.
- Basic IDD and IDDQ Measurement Conditions are described in Table 2.
- Detailed IDD and IDDQ Measurement-Loop Patterns are described in Table 3 through Table 10.
- IDD Measurements are done after properly initializing the DDR3 SDRAM. This includes but is not limited to setting
 $RON = RZQ/7$ (34 Ohm in MR1);
 $Q_{off} = 0_B$ (Output Buffer enabled in MR1);
 $RTT_{Nom} = RZQ/6$ (40 Ohm in MR1);
 $RTT_{Wr} = RZQ/2$ (120 Ohm in MR2);
 TDQS Feature disabled in MR1
- Attention: The IDD and IDDQ Measurement-Loop Patterns need to be executed at least one time before actual IDD or IDDQ measurement is started.
- Define $\overline{D} = \{\overline{CS}, \overline{RAS}, \overline{CAS}, \overline{WE}\} = \{HIGH, LOW, LOW, LOW\}$
- Define $\overline{\overline{D}} = \{\overline{\overline{CS}}, \overline{\overline{RAS}}, \overline{\overline{CAS}}, \overline{\overline{WE}}\} = \{HIGH, HIGH, HIGH, HIGH\}$

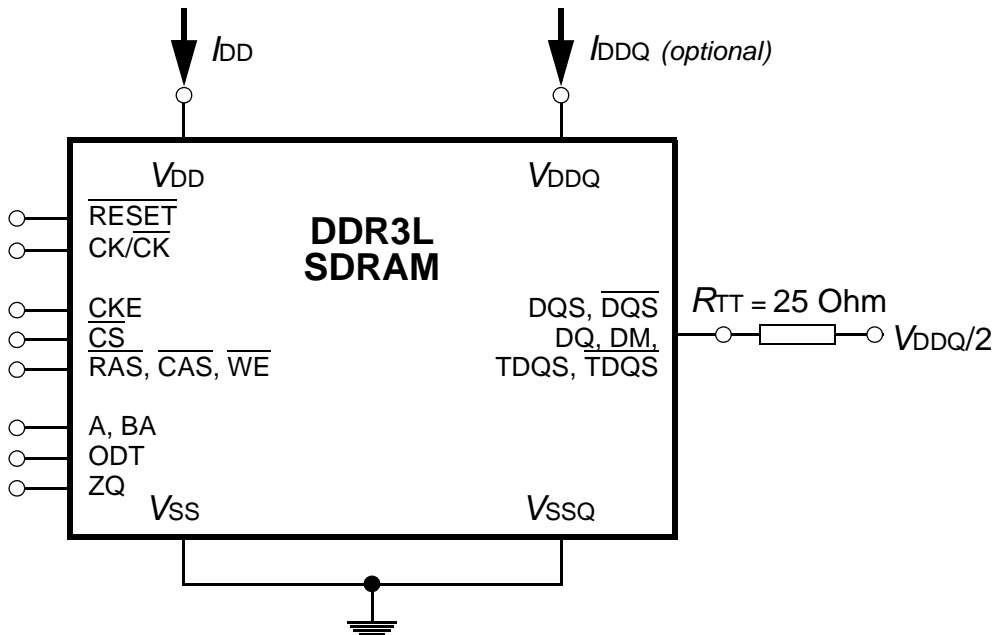

Figure 1 - Measurement Setup and Test Load for I_{DD} and I_{DDQ} (optional) Measurements
 [Note: DIMM level Output test load condition may be different from above]

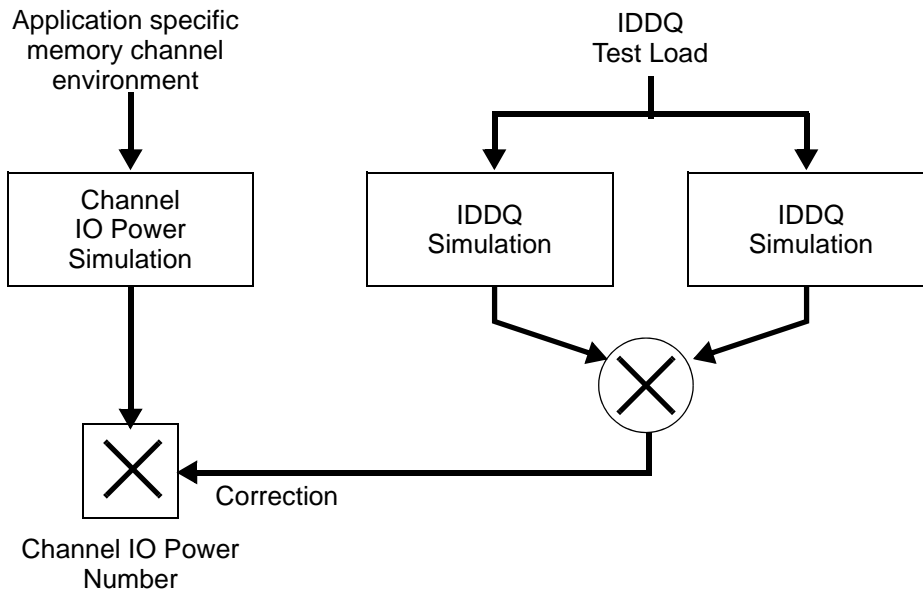

Figure 2 - Correlation from simulated Channel IO Power to actual Channel IO Power supported by I_{DDQ} Measurement

Table 1 -Timings used for IDD and IDDQ Measurement-Loop Patterns

| Symbol | | DDR3L-1066 | DDR3L-1333 | Unit |
|------------------|---------------|------------|------------|------|
| | | 7-7-7 | 9-9-9 | |
| t_{CK} | | 1.875 | 1.5 | ns |
| CL | | 7 | 9 | nCK |
| n_{RCD} | | 7 | 9 | nCK |
| n_{RC} | | 27 | 33 | nCK |
| n_{RAS} | | 20 | 24 | nCK |
| n_{RP} | | 7 | 9 | nCK |
| n_{FAW} | 1KB page size | 20 | 20 | nCK |
| | 2KB page size | 27 | 30 | nCK |
| n_{RRD} | 1KB page size | 4 | 4 | nCK |
| | 2KB page size | 6 | 5 | nCK |
| n_{RFC} -512Mb | | 48 | 60 | nCK |
| n_{RFC} -1 Gb | | 59 | 74 | nCK |
| n_{RFC} - 2 Gb | | 86 | 107 | nCK |
| n_{RFC} - 4 Gb | | 139 | 174 | nCK |
| n_{RFC} - 8 Gb | | 187 | 234 | nCK |

Table 2 -Basic IDD and IDDQ Measurement Conditions

| Symbol | Description |
|-----------|---|
| I_{DD0} | <p>Operating One Bank Active-Precharge Current</p> <p>CKE: High; External clock: On; tCK, nRC, nRAS, CL: see Table 1; BL: 8^a); AL: 0; \overline{CS}: High between ACT and PRE; Command, Address, Bank Address Inputs: partially toggling according to Table 3; Data IO: MID-LEVEL; DM: stable at 0; Bank Activity: Cycling with one bank active at a time: 0,0,1,1,2,2,... (see Table 3); Output Buffer and RTT: Enabled in Mode Registers^b); ODT Signal: stable at 0; Pattern Details: see Table 3.</p> |
| I_{DD1} | <p>Operating One Bank Active-Precharge Current</p> <p>CKE: High; External clock: On; tCK, nRC, nRAS, nRCD, CL: see Table 1; BL: 8^a); AL: 0; \overline{CS}: High between ACT, RD and PRE; Command, Address; Bank Address Inputs, Data IO: partially toggling according to Table 4; DM: stable at 0; Bank Activity: Cycling with on bank active at a time: 0,0,1,1,2,2,... (see Table 4); Output Buffer and RTT: Enabled in Mode Registers^b); ODT Signal: stable at 0; Pattern Details: see Table 4.</p> |

| Symbol | Description |
|-------------|---|
| I_{DD2N} | Precharge Standby Current CKE: High; External clock: On; tCK, CL: see Table 1; BL: 8 ^{a)} ; AL: 0; \overline{CS} : stable at 1; Command, Address, Bank Address Inputs: partially toggling according to Table 5; Data IO: MID_LEVEL; DM: stable at 0; Bank Activity: all banks closed; Output Buffer and RTT: Enabled in Mode Registers ^{b)} ; ODT Signal: stable at 0; Pattern Details: see Table 5. |
| I_{DD2NT} | Precharge Standby ODT Current CKE: High; External clock: On; tCK, CL: see Table 1; BL: 8 ^{a)} ; AL: 0; \overline{CS} : stable at 1; Command, Address, Bank Address Inputs: partially toggling according to Table 6; Data IO: MID_LEVEL; DM: stable at 0; Bank Activity: all banks closed; Output Buffer and RTT: Enabled in Mode Registers ^{b)} ; ODT Signal: toggling according to Table 6; Pattern Details: see Table 6. |
| I_{DD2P0} | Precharge Power-Down Current Slow Exit CKE: Low; External clock: On; tCK, CL: see Table 1; BL: 8 ^{a)} ; AL: 0; \overline{CS} : stable at 1; Command, Address, Bank Address Inputs: stable at 0; Data IO: MID_LEVEL; DM: stable at 0; Bank Activity: all banks closed; Output Buffer and RTT: Enabled in Mode Registers ^{b)} ; ODT Signal: stable at 0; Precharge Power Down Mode: Slow Exit ^{c)} |
| I_{DD2P1} | Precharge Power-Down Current Fast Exit CKE: Low; External clock: On; tCK, CL: see Table 1; BL: 8 ^{a)} ; AL: 0; \overline{CS} : stable at 1; Command, Address, Bank Address Inputs: stable at 0; Data IO: MID_LEVEL; DM: stable at 0; Bank Activity: all banks closed; Output Buffer and RTT: Enabled in Mode Registers ^{b)} ; ODT Signal: stable at 0; Precharge Power Down Mode: Fast Exit ^{c)} |
| I_{DD2Q} | Precharge Quiet Standby Current CKE: High; External clock: On; tCK, CL: see Table 1; BL: 8 ^{a)} ; AL: 0; \overline{CS} : stable at 1; Command, Address, Bank Address Inputs: stable at 0; Data IO: MID_LEVEL; DM: stable at 0; Bank Activity: all banks closed; Output Buffer and RTT: Enabled in Mode Registers ^{b)} ; ODT Signal: stable at 0 |
| I_{DD3N} | Active Standby Current CKE: High; External clock: On; tCK, CL: see Table 1; BL: 8 ^{a)} ; AL: 0; \overline{CS} : stable at 1; Command, Address, Bank Address Inputs: partially toggling according to Table 5; Data IO: MID_LEVEL; DM: stable at 0; Bank Activity: all banks open; Output Buffer and RTT: Enabled in Mode Registers ^{b)} ; ODT Signal: stable at 0; Pattern Details: see Table 5. |
| I_{DD3P} | Active Power-Down Current CKE: Low; External clock: On; tCK, CL: see Table 1; BL: 8 ^{a)} ; AL: 0; \overline{CS} : stable at 1; Command, Address, Bank Address Inputs: stable at 0; Data IO: MID_LEVEL; DM: stable at 0; Bank Activity: all banks open; Output Buffer and RTT: Enabled in Mode Registers ^{b)} ; ODT Signal: stable at 0 |

| Symbol | Description |
|-------------|---|
| I_{DD4R} | <p>Operating Burst Read Current</p> <p>CKE: High; External clock: On; tCK, CL: see Table 1; BL: 8^{a)}; AL: 0; \overline{CS}: High between RD; Command, Address, Bank Address Inputs: partially toggling according to Table 7; Data IO: seamless read data burst with different data between one burst and the next one according to Table 7; DM: stable at 0; Bank Activity: all banks open, RD commands cycling through banks: 0,0,1,1,2,2,...(see Table 7); Output Buffer and RTT: Enabled in Mode Registers^{b)}; ODT Signal: stable at 0; Pattern Details: see Table 7.</p> |
| I_{DD4W} | <p>Operating Burst Write Current</p> <p>CKE: High; External clock: On; tCK, CL: see Table 1; BL: 8^{a)}; AL: 0; \overline{CS}: High between WR; Command, Address, Bank Address Inputs: partially toggling according to Table 8; Data IO: seamless read data burst with different data between one burst and the next one according to Table 8; DM: stable at 0; Bank Activity: all banks open, WR commands cycling through banks: 0,0,1,1,2,2,...(see Table 8); Output Buffer and RTT: Enabled in Mode Registers^{b)}; ODT Signal: stable at HIGH; Pattern Details: see Table 8.</p> |
| I_{DD5B} | <p>Burst Refresh Current</p> <p>CKE: High; External clock: On; tCK, CL, nRFC: see Table 1; BL: 8^{a)}; AL: 0; \overline{CS}: High between REF; Command, Address, Bank Address Inputs: partially toggling according to Table 9; Data IO: MID_LEVEL; DM: stable at 0; Bank Activity: REF command every nREF (see Table 9); Output Buffer and RTT: Enabled in Mode Registers^{b)}; ODT Signal: stable at 0; Pattern Details: see Table 9.</p> |
| I_{DD6} | <p>Self-Refresh Current: Normal Temperature Range</p> <p>T_{CASE}: 0 - 85 °C; Auto Self-Refresh (ASR): Disabled^{d)}; Self-Refresh Temperature Range (SRT): Normal^{e)}; CKE: Low; External clock: Off; CK and \overline{CK}: LOW; CL: see Table 1; BL: 8^{a)}; AL: 0; \overline{CS}, Command, Address, Bank Address Inputs, Data IO: MID_LEVEL; DM: stable at 0; Bank Activity: Self-Refresh operation; Output Buffer and RTT: Enabled in Mode Registers^{b)}; ODT Signal: MID_LEVEL</p> |
| I_{DD6ET} | <p>Self-Refresh Current: Extended Temperature Range (optional)</p> <p>T_{CASE}: 0 - 95 °C; Auto Self-Refresh (ASR): Disabled^{d)}; Self-Refresh Temperature Range (SRT): Extended^{e)}; CKE: Low; External clock: Off; CK and \overline{CK}: LOW; CL: see Table 1; BL: 8^{a)}; AL: 0; \overline{CS}, Command, Address, Bank Address Inputs, Data IO: MID_LEVEL; DM: stable at 0; Bank Activity: Extended Temperature Self-Refresh operation; Output Buffer and RTT: Enabled in Mode Registers^{b)}; ODT Signal: MID_LEVEL</p> |

| Symbol | Description |
|------------------------|--|
| I_{DD7} | Operating Bank Interleave Read Current CKE: High; External clock: On; tCK, nRC, nRAS, nRCD, NRRD, nFAW, CL: see Table 1; BL: 8 ^{a),f)} ; AL: CL-1; \overline{CS} : High between ACT and RDA; Command, Address, Bank Address Inputs: partially toggling according to Table 10; Data IO: read data burst with different data between one burst and the next one according to Table 10; DM: stable at 0; Bank Activity: two times interleaved cycling through banks (0, 1,...7) with different addressing, see Table 10; Output Buffer and RTT: Enabled in Mode Registers ^{b)} ; ODT Signal: stable at 0; Pattern Details: see Table 10. |

- a) Burst Length: BL8 fixed by MRS: set MR0 A[1,0]=00B
- b) Output Buffer Enable: set MR1 A[12] = 0B; set MR1 A[5,1] = 01B; RTT_Nom enable: set MR1 A[9,6,2] = 011B; RTT_Wr enable: set MR2 A[10,9] = 10B
- c) Precharge Power Down Mode: set MR0 A12=0B for Slow Exit or MR0 A12 = 1B for Fast Exit
- d) Auto Self-Refresh (ASR): set MR2 A6 = 0B to disable or 1B to enable feature
- e) Self-Refresh Temperature Range (SRT): set MR2 A7 = 0B for normal or 1B for extended temperature range
- f) Read Burst Type: Nibble Sequential, set MR0 A[3] = 0B

Table 3 - IDD0 Measurement-Loop Pattern^{a)}

| $\overline{\text{CK}}, \text{CK}$ | CKE | Sub-Loop | Cycle Number | Command | $\overline{\text{CS}}$ | $\overline{\text{RAS}}$ | $\overline{\text{CAS}}$ | $\overline{\text{WE}}$ | ODT | BA[2:0] | A[15:11] | A[10] | A[9:7] | A[6:3] | A[2:0] | Data ^{b)} | | |
|-----------------------------------|-------------|--|---|--|------------------------|-------------------------|-------------------------|------------------------|-----|---------|----------|-------|--------|--------|--------|--------------------|---|--|
| toggling | Static High | 0 | 0 | ACT | 0 | 0 | 1 | 1 | 0 | 0 | 00 | 0 | 0 | 0 | 0 | - | | |
| | | | 1,2 | D, D | 1 | 0 | 0 | 0 | 0 | 0 | 0 | 00 | 0 | 0 | 0 | 0 | - | |
| | | | 3,4 | $\overline{\text{D}}, \overline{\text{D}}$ | 1 | 1 | 1 | 1 | 0 | 0 | 0 | 00 | 0 | 0 | 0 | 0 | - | |
| | | | ... | repeat pattern 1...4 until nRAS - 1, truncate if necessary | | | | | | | | | | | | | | |
| | | | nRAS | PRE | 0 | 0 | 1 | 0 | 0 | 0 | 0 | 00 | 0 | 0 | 0 | 0 | - | |
| | | | ... | repeat pattern 1...4 until nRC - 1, truncate if necessary | | | | | | | | | | | | | | |
| | | | 1*nRC+0 | ACT | 0 | 0 | 1 | 1 | 0 | 0 | 00 | 0 | 0 | F | 0 | - | | |
| | | | 1*nRC+1, 2 | D, D | 1 | 0 | 0 | 0 | 0 | 0 | 00 | 0 | 0 | F | 0 | - | | |
| | | | 1*nRC+3, 4 | $\overline{\text{D}}, \overline{\text{D}}$ | 1 | 1 | 1 | 1 | 0 | 0 | 00 | 0 | 0 | F | 0 | - | | |
| | | | ... | repeat pattern 1...4 until 1*nRC + nRAS - 1, truncate if necessary | | | | | | | | | | | | | | |
| | | | 1*nRC+nRAS | PRE | 0 | 0 | 1 | 0 | 0 | 0 | 00 | 0 | 0 | F | 0 | - | | |
| | | ... | repeat pattern 1...4 until 2*nRC - 1, truncate if necessary | | | | | | | | | | | | | | | |
| | | 1 | 2*nRC | repeat Sub-Loop 0, use BA[2:0] = 1 instead | | | | | | | | | | | | | | |
| | | 2 | 4*nRC | repeat Sub-Loop 0, use BA[2:0] = 2 instead | | | | | | | | | | | | | | |
| | | 3 | 6*nRC | repeat Sub-Loop 0, use BA[2:0] = 3 instead | | | | | | | | | | | | | | |
| | | 4 | 8*nRC | repeat Sub-Loop 0, use BA[2:0] = 4 instead | | | | | | | | | | | | | | |
| | | 5 | 10*nRC | repeat Sub-Loop 0, use BA[2:0] = 5 instead | | | | | | | | | | | | | | |
| 6 | 12*nRC | repeat Sub-Loop 0, use BA[2:0] = 6 instead | | | | | | | | | | | | | | | | |
| 7 | 14*nRC | repeat Sub-Loop 0, use BA[2:0] = 7 instead | | | | | | | | | | | | | | | | |

a) DM must be driven LOW all the time. DQS, $\overline{\text{DQS}}$ are MID-LEVEL.

b) DQ signals are MID-LEVEL.

Table 4 - IDD1 Measurement-Loop Pattern^{a)}

| CK, CK | CKE | Sub-Loop | Cycle Number | Command | $\overline{\text{CS}}$ | $\overline{\text{RAS}}$ | $\overline{\text{CAS}}$ | $\overline{\text{WE}}$ | ODT | BA[2:0] | A[15:11] | A[10] | A[9:7] | A[6:3] | A[2:0] | Data ^{b)} | | |
|----------|-------------|--|---|---|------------------------|-------------------------|-------------------------|------------------------|-----|---------|----------|-------|--------|--------|--------|--------------------|----------|----------|
| toggling | Static High | 0 | 0 | ACT | 0 | 0 | 1 | 1 | 0 | 0 | 00 | 0 | 0 | 0 | 0 | - | | |
| | | | 1,2 | D, D | 1 | 0 | 0 | 0 | 0 | 0 | 0 | 00 | 0 | 0 | 0 | 0 | - | |
| | | | 3,4 | $\overline{\text{D}}, \overline{\text{D}}$ | 1 | 1 | 1 | 1 | 0 | 0 | 0 | 00 | 0 | 0 | 0 | 0 | - | |
| | | | ... | repeat pattern 1...4 until nRCD - 1, truncate if necessary | | | | | | | | | | | | | | |
| | | | nRCD | RD | 0 | 1 | 0 | 1 | 0 | 0 | 0 | 00 | 0 | 0 | 0 | 0 | 0 | 00000000 |
| | | | ... | repeat pattern 1...4 until nRAS - 1, truncate if necessary | | | | | | | | | | | | | | |
| | | | nRAS | PRE | 0 | 0 | 1 | 0 | 0 | 0 | 0 | 00 | 0 | 0 | 0 | 0 | - | |
| | | | ... | repeat pattern 1...4 until nRC - 1, truncate if necessary | | | | | | | | | | | | | | |
| | | | 1*nRC+0 | ACT | 0 | 0 | 1 | 1 | 0 | 0 | 0 | 00 | 0 | 0 | F | 0 | - | |
| | | | 1*nRC+1,2 | D, D | 1 | 0 | 0 | 0 | 0 | 0 | 0 | 00 | 0 | 0 | F | 0 | - | |
| | | | 1*nRC+3,4 | $\overline{\text{D}}, \overline{\text{D}}$ | 1 | 1 | 1 | 1 | 0 | 0 | 0 | 00 | 0 | 0 | F | 0 | - | |
| | | | ... | repeat pattern nRC + 1,...4 until nRC + nRCE - 1, truncate if necessary | | | | | | | | | | | | | | |
| | | | 1*nRC+nRCD | RD | 0 | 1 | 0 | 1 | 0 | 0 | 0 | 00 | 0 | 0 | F | 0 | 00110011 | |
| | | | ... | repeat pattern nRC + 1,...4 until nRC + nRAS - 1, truncate if necessary | | | | | | | | | | | | | | |
| | | 1*nRC+nRAS | PRE | 0 | 0 | 1 | 0 | 0 | 0 | 0 | 00 | 0 | 0 | F | 0 | - | | |
| | | ... | repeat pattern nRC + 1,...4 until *2 nRC - 1, truncate if necessary | | | | | | | | | | | | | | | |
| | | 1 | 2*nRC | repeat Sub-Loop 0, use BA[2:0] = 1 instead | | | | | | | | | | | | | | |
| | | 2 | 4*nRC | repeat Sub-Loop 0, use BA[2:0] = 2 instead | | | | | | | | | | | | | | |
| | | 3 | 6*nRC | repeat Sub-Loop 0, use BA[2:0] = 3 instead | | | | | | | | | | | | | | |
| | | 4 | 8*nRC | repeat Sub-Loop 0, use BA[2:0] = 4 instead | | | | | | | | | | | | | | |
| 5 | 10*nRC | repeat Sub-Loop 0, use BA[2:0] = 5 instead | | | | | | | | | | | | | | | | |
| 6 | 12*nRC | repeat Sub-Loop 0, use BA[2:0] = 6 instead | | | | | | | | | | | | | | | | |
| 7 | 14*nRC | repeat Sub-Loop 0, use BA[2:0] = 7 instead | | | | | | | | | | | | | | | | |

a) DM must be driven LOW all the time. DQS, $\overline{\text{DQS}}$ are used according to RD Commands, otherwise MID-LEVEL.

b) Burst Sequence driven on each DQ signal by Read Command. Outside burst operation, DQ signals are MID-LEVEL.

Table 5 - IDD2N and IDD3N Measurement-Loop Pattern^{a)}

| $\overline{\text{CK}}$, CK | CKE | Sub-Loop | Cycle Number | Command | $\overline{\text{CS}}$ | $\overline{\text{RAS}}$ | $\overline{\text{CAS}}$ | $\overline{\text{WE}}$ | ODT | BA[2:0] | A[15:11] | A[10] | A[9:7] | A[6:3] | A[2:0] | Data ^{b)} | |
|-----------------------------|-------------|----------|--------------|--|------------------------|-------------------------|-------------------------|------------------------|-----|---------|----------|-------|--------|--------|--------|--------------------|---|
| toggling | Static High | 0 | 0 | D | 1 | 0 | 0 | 0 | 0 | 0 | 0 | 0 | 0 | 0 | 0 | - | |
| | | | 1 | D | 1 | 0 | 0 | 0 | 0 | 0 | 0 | 0 | 0 | 0 | 0 | 0 | - |
| | | | 2 | D | 1 | 1 | 1 | 1 | 1 | 0 | 0 | 0 | 0 | 0 | F | 0 | - |
| | | | 3 | D | 1 | 1 | 1 | 1 | 1 | 0 | 0 | 0 | 0 | 0 | F | 0 | - |
| | | 1 | 4-7 | repeat Sub-Loop 0, use BA[2:0] = 1 instead | | | | | | | | | | | | | |
| | | 2 | 8-11 | repeat Sub-Loop 0, use BA[2:0] = 2 instead | | | | | | | | | | | | | |
| | | 3 | 12-15 | repeat Sub-Loop 0, use BA[2:0] = 3 instead | | | | | | | | | | | | | |
| | | 4 | 16-19 | repeat Sub-Loop 0, use BA[2:0] = 4 instead | | | | | | | | | | | | | |
| | | 5 | 20-23 | repeat Sub-Loop 0, use BA[2:0] = 5 instead | | | | | | | | | | | | | |
| | | 6 | 24-17 | repeat Sub-Loop 0, use BA[2:0] = 6 instead | | | | | | | | | | | | | |
| | | 7 | 28-31 | repeat Sub-Loop 0, use BA[2:0] = 7 instead | | | | | | | | | | | | | |

a) DM must be driven LOW all the time. DQS, $\overline{\text{DQS}}$ are MID-LEVEL.

b) DQ signals are MID-LEVEL.

Table 6 - IDD2NT and IDDQ2NT Measurement-Loop Pattern^{a)}

| $\overline{\text{CK}}$, CK | CKE | Sub-Loop | Cycle Number | Command | $\overline{\text{CS}}$ | $\overline{\text{RAS}}$ | $\overline{\text{CAS}}$ | $\overline{\text{WE}}$ | ODT | BA[2:0] | A[15:11] | A[10] | A[9:7] | A[6:3] | A[2:0] | Data ^{b)} | |
|-----------------------------|-------------|----------|--------------|--|------------------------|-------------------------|-------------------------|------------------------|-----|---------|----------|-------|--------|--------|--------|--------------------|---|
| toggling | Static High | 0 | 0 | D | 1 | 0 | 0 | 0 | 0 | 0 | 0 | 0 | 0 | 0 | 0 | - | |
| | | | 1 | D | 1 | 0 | 0 | 0 | 0 | 0 | 0 | 0 | 0 | 0 | 0 | 0 | - |
| | | | 2 | D | 1 | 1 | 1 | 1 | 1 | 0 | 0 | 0 | 0 | 0 | F | 0 | - |
| | | | 3 | D | 1 | 1 | 1 | 1 | 1 | 0 | 0 | 0 | 0 | 0 | F | 0 | - |
| | | 1 | 4-7 | repeat Sub-Loop 0, but ODT = 0 and BA[2:0] = 1 | | | | | | | | | | | | | |
| | | 2 | 8-11 | repeat Sub-Loop 0, but ODT = 1 and BA[2:0] = 2 | | | | | | | | | | | | | |
| | | 3 | 12-15 | repeat Sub-Loop 0, but ODT = 1 and BA[2:0] = 3 | | | | | | | | | | | | | |
| | | 4 | 16-19 | repeat Sub-Loop 0, but ODT = 0 and BA[2:0] = 4 | | | | | | | | | | | | | |
| | | 5 | 20-23 | repeat Sub-Loop 0, but ODT = 0 and BA[2:0] = 5 | | | | | | | | | | | | | |
| | | 6 | 24-17 | repeat Sub-Loop 0, but ODT = 1 and BA[2:0] = 6 | | | | | | | | | | | | | |
| | | 7 | 28-31 | repeat Sub-Loop 0, but ODT = 1 and BA[2:0] = 7 | | | | | | | | | | | | | |

a) DM must be driven LOW all the time. DQS, $\overline{\text{DQS}}$ are MID-LEVEL.

b) DQ signals are MID-LEVEL.

Table 7 - IDD4R and IDDQ4R Measurement-Loop Pattern^{a)}

| $\overline{\text{CK}}, \text{CK}$ | CKE | Sub-Loop | Cycle Number | Command | $\overline{\text{CS}}$ | $\overline{\text{RAS}}$ | $\overline{\text{CAS}}$ | $\overline{\text{WE}}$ | ODT | BA[2:0] | A[15:11] | A[10] | A[9:7] | A[6:3] | A[2:0] | Data ^{b)} | | |
|-----------------------------------|-------------|----------|--|--|------------------------|-------------------------|-------------------------|------------------------|-----|---------|----------|-------|--------|--------|--------|--------------------|--|--|
| toggling | Static High | 0 | 0 | RD | 0 | 1 | 0 | 1 | 0 | 0 | 00 | 0 | 0 | 0 | 0 | 00000000 | | |
| | | | 1 | D | 1 | 0 | 0 | 0 | 0 | 0 | 00 | 0 | 0 | 0 | 0 | - | | |
| | | | 2,3 | $\overline{\text{D}}, \overline{\text{D}}$ | 1 | 1 | 1 | 1 | 0 | 0 | 00 | 0 | 0 | 0 | 0 | - | | |
| | | | 4 | RD | 0 | 1 | 0 | 1 | 0 | 0 | 00 | 0 | 0 | F | 0 | 00110011 | | |
| | | 5 | D | 1 | 0 | 0 | 0 | 0 | 0 | 0 | 00 | 0 | 0 | F | 0 | - | | |
| | | 6,7 | $\overline{\text{D}}, \overline{\text{D}}$ | 1 | 1 | 1 | 1 | 0 | 0 | 00 | 0 | 0 | 0 | F | 0 | - | | |
| | | 1 | 8-15 | repeat Sub-Loop 0, but BA[2:0] = 1 | | | | | | | | | | | | | | |
| | | 2 | 16-23 | repeat Sub-Loop 0, but BA[2:0] = 2 | | | | | | | | | | | | | | |
| | | 3 | 24-31 | repeat Sub-Loop 0, but BA[2:0] = 3 | | | | | | | | | | | | | | |
| | | 4 | 32-39 | repeat Sub-Loop 0, but BA[2:0] = 4 | | | | | | | | | | | | | | |
| | | 5 | 40-47 | repeat Sub-Loop 0, but BA[2:0] = 5 | | | | | | | | | | | | | | |
| | | 6 | 48-55 | repeat Sub-Loop 0, but BA[2:0] = 6 | | | | | | | | | | | | | | |
| | | 7 | 56-63 | repeat Sub-Loop 0, but BA[2:0] = 7 | | | | | | | | | | | | | | |

a) DM must be driven LOW all the time. DQS, $\overline{\text{DQS}}$ are used according to RD Commands, otherwise MID-LEVEL.

b) Burst Sequence driven on each DQ signal by Read Command. Outside burst operation, DQ signals are MID-LEVEL.

Table 8 - IDD4W Measurement-Loop Pattern^{a)}

| $\overline{\text{CK}}, \text{CK}$ | CKE | Sub-Loop | Cycle Number | Command | $\overline{\text{CS}}$ | $\overline{\text{RAS}}$ | $\overline{\text{CAS}}$ | $\overline{\text{WE}}$ | ODT | BA[2:0] | A[15:11] | A[10] | A[9:7] | A[6:3] | A[2:0] | Data ^{b)} | | |
|-----------------------------------|-------------|----------|--|--|------------------------|-------------------------|-------------------------|------------------------|-----|---------|----------|-------|--------|--------|--------|--------------------|--|--|
| toggling | Static High | 0 | 0 | WR | 0 | 1 | 0 | 0 | 1 | 0 | 00 | 0 | 0 | 0 | 0 | 00000000 | | |
| | | | 1 | D | 1 | 0 | 0 | 0 | 1 | 0 | 00 | 0 | 0 | 0 | 0 | - | | |
| | | | 2,3 | $\overline{\text{D}}, \overline{\text{D}}$ | 1 | 1 | 1 | 1 | 1 | 0 | 00 | 0 | 0 | 0 | 0 | - | | |
| | | | 4 | WR | 0 | 1 | 0 | 0 | 1 | 0 | 00 | 0 | 0 | F | 0 | 00110011 | | |
| | | 5 | D | 1 | 0 | 0 | 0 | 1 | 0 | 00 | 0 | 0 | F | 0 | - | | | |
| | | 6,7 | $\overline{\text{D}}, \overline{\text{D}}$ | 1 | 1 | 1 | 1 | 1 | 0 | 00 | 0 | 0 | 0 | F | 0 | - | | |
| | | 1 | 8-15 | repeat Sub-Loop 0, but BA[2:0] = 1 | | | | | | | | | | | | | | |
| | | 2 | 16-23 | repeat Sub-Loop 0, but BA[2:0] = 2 | | | | | | | | | | | | | | |
| | | 3 | 24-31 | repeat Sub-Loop 0, but BA[2:0] = 3 | | | | | | | | | | | | | | |
| | | 4 | 32-39 | repeat Sub-Loop 0, but BA[2:0] = 4 | | | | | | | | | | | | | | |
| | | 5 | 40-47 | repeat Sub-Loop 0, but BA[2:0] = 5 | | | | | | | | | | | | | | |
| | | 6 | 48-55 | repeat Sub-Loop 0, but BA[2:0] = 6 | | | | | | | | | | | | | | |
| | | 7 | 56-63 | repeat Sub-Loop 0, but BA[2:0] = 7 | | | | | | | | | | | | | | |

a) DM must be driven LOW all the time. DQS, $\overline{\text{DQS}}$ are used according to WR Commands, otherwise MID-LEVEL.

b) Burst Sequence driven on each DQ signal by Write Command. Outside burst operation, DQ signals are MID-LEVEL.

Table 9 - IDD5B Measurement-Loop Pattern^{a)}

| $\overline{\text{CK}}$, CK | CKE | Sub-Loop | Cycle Number | Command | $\overline{\text{CS}}$ | $\overline{\text{RAS}}$ | $\overline{\text{CAS}}$ | $\overline{\text{WE}}$ | ODT | BA[2:0] | A[15:11] | A[10] | A[9:7] | A[6:3] | A[2:0] | Data ^{b)} | |
|-----------------------------|-------------|----------|--------------|--------------------------------------|--|-------------------------|-------------------------|------------------------|-----|---------|----------|-------|--------|--------|--------|--------------------|---|
| toggling | Static High | 0 | 0 | REF | 0 | 0 | 0 | 1 | 0 | 0 | 0 | 0 | 0 | 0 | 0 | - | |
| | | 1 | 1,2 | D, D | 1 | 0 | 0 | 0 | 0 | 0 | 0 | 00 | 0 | 0 | 0 | 0 | - |
| | | | 3,4 | D, D | 1 | 1 | 1 | 1 | 1 | 0 | 0 | 00 | 0 | 0 | F | 0 | - |
| | | | 5...8 | repeat cycles 1...4, but BA[2:0] = 1 | | | | | | | | | | | | | |
| | | | 9...12 | repeat cycles 1...4, but BA[2:0] = 2 | | | | | | | | | | | | | |
| | | | 13...16 | repeat cycles 1...4, but BA[2:0] = 3 | | | | | | | | | | | | | |
| | | | 17...20 | repeat cycles 1...4, but BA[2:0] = 4 | | | | | | | | | | | | | |
| | | | 21...24 | repeat cycles 1...4, but BA[2:0] = 5 | | | | | | | | | | | | | |
| | | | 25...28 | repeat cycles 1...4, but BA[2:0] = 6 | | | | | | | | | | | | | |
| | | | 29...32 | repeat cycles 1...4, but BA[2:0] = 7 | | | | | | | | | | | | | |
| | | | 2 | 33...nRFC-1 | repeat Sub-Loop 1, until nRFC - 1. Truncate, if necessary. | | | | | | | | | | | | |

a) DM must be driven LOW all the time. DQS, $\overline{\text{DQS}}$ are MID-LEVEL.

b) DQ signals are MID-LEVEL.

Table 10 - IDD7 Measurement-Loop Pattern^{a)}

ATTENTION! Sub-Loops 10-19 have inverse A[6:3] Pattern and Data Pattern than Sub-Loops 0-9

| CK, $\overline{\text{CK}}$ | CKE | Sub-Loop | Cycle Number | Command | $\overline{\text{CS}}$ | $\overline{\text{RAS}}$ | $\overline{\text{CAS}}$ | $\overline{\text{WE}}$ | ODT | BA[2:0] | A[15:11] | A[10] | A[9:7] | A[6:3] | A[2:0] | Data ^{b)} | | | |
|----------------------------|---------------|---|--|---|------------------------|-------------------------|-------------------------|------------------------|-----|---------|----------|-------|--------|--------|--------|--------------------|----------|---|--|
| toggling | Static High | 0 | 0 | ACT | 0 | 0 | 1 | 1 | 0 | 0 | 00 | 0 | 0 | 0 | 0 | - | | | |
| | | | 1 | RDA | 0 | 1 | 0 | 1 | 0 | 0 | 00 | 1 | 0 | 0 | 0 | 0 | 00000000 | | |
| | | | 2 | D | 1 | 0 | 0 | 0 | 0 | 0 | 0 | 00 | 0 | 0 | 0 | 0 | 0 | - | |
| | | ... | repeat above D Command until nRRD - 1 | | | | | | | | | | | | | | | | |
| | | 1 | nRRD | ACT | 0 | 0 | 1 | 1 | 0 | 1 | 00 | 0 | 0 | 0 | F | 0 | - | | |
| | | | nRRD+1 | RDA | 0 | 1 | 0 | 1 | 0 | 1 | 00 | 1 | 0 | 0 | F | 0 | 00110011 | | |
| | | | nRRD+2 | D | 1 | 0 | 0 | 0 | 0 | 1 | 00 | 0 | 0 | 0 | F | 0 | - | | |
| | | ... | repeat above D Command until 2* nRRD - 1 | | | | | | | | | | | | | | | | |
| | | 2 | 2*nRRD | repeat Sub-Loop 0, but BA[2:0] = 2 | | | | | | | | | | | | | | | |
| | | 3 | 3*nRRD | repeat Sub-Loop 1, but BA[2:0] = 3 | | | | | | | | | | | | | | | |
| | | 4 | 4*nRRD | D | 1 | 0 | 0 | 0 | 0 | 3 | 00 | 0 | 0 | 0 | F | 0 | - | | |
| | | | | Assert and repeat above D Command until nFAW - 1, if necessary | | | | | | | | | | | | | | | |
| | | 5 | nFAW | repeat Sub-Loop 0, but BA[2:0] = 4 | | | | | | | | | | | | | | | |
| | | 6 | nFAW+nRRD | repeat Sub-Loop 1, but BA[2:0] = 5 | | | | | | | | | | | | | | | |
| | | 7 | nFAW+2*nRRD | repeat Sub-Loop 0, but BA[2:0] = 6 | | | | | | | | | | | | | | | |
| | | 8 | nFAW+3*nRRD | repeat Sub-Loop 1, but BA[2:0] = 7 | | | | | | | | | | | | | | | |
| | | 9 | nFAW+4*nRRD | D | 1 | 0 | 0 | 0 | 0 | 7 | 00 | 0 | 0 | 0 | F | 0 | - | | |
| | | | | Assert and repeat above D Command until 2* nFAW - 1, if necessary | | | | | | | | | | | | | | | |
| | | 10 | 2*nFAW+0 | ACT | 0 | 0 | 1 | 1 | 0 | 0 | 00 | 0 | 0 | 0 | F | 0 | - | | |
| | | | | RDA | 0 | 1 | 0 | 1 | 0 | 0 | 00 | 1 | 0 | 0 | F | 0 | 00110011 | | |
| | | | | D | 1 | 0 | 0 | 0 | 0 | 0 | 00 | 0 | 0 | 0 | F | 0 | - | | |
| | | 2&nFAW+2 | Repeat above D Command until 2* nFAW + nRRD - 1 | | | | | | | | | | | | | | | | |
| | | 11 | 2*nFAW+nRRD | ACT | 0 | 0 | 1 | 1 | 0 | 1 | 00 | 0 | 0 | 0 | 0 | 0 | - | | |
| | | | | RDA | 0 | 1 | 0 | 1 | 0 | 1 | 00 | 1 | 0 | 0 | 0 | 0 | 00000000 | | |
| | | | | D | 1 | 0 | 0 | 0 | 0 | 1 | 00 | 0 | 0 | 0 | 0 | 0 | - | | |
| | | 2&nFAW+nRRD+2 | Repeat above D Command until 2* nFAW + 2* nRRD - 1 | | | | | | | | | | | | | | | | |
| | | 12 | 2*nFAW+2*nRRD | repeat Sub-Loop 10, but BA[2:0] = 2 | | | | | | | | | | | | | | | |
| | | 13 | 2*nFAW+3*nRRD | repeat Sub-Loop 11, but BA[2:0] = 3 | | | | | | | | | | | | | | | |
| | | 14 | 2*nFAW+4*nRRD | D | 1 | 0 | 0 | 0 | 0 | 3 | 00 | 0 | 0 | 0 | 0 | 0 | - | | |
| | | | | Assert and repeat above D Command until 3* nFAW - 1, if necessary | | | | | | | | | | | | | | | |
| 15 | 3*nFAW | repeat Sub-Loop 10, but BA[2:0] = 4 | | | | | | | | | | | | | | | | | |
| 16 | 3*nFAW+nRRD | repeat Sub-Loop 11, but BA[2:0] = 5 | | | | | | | | | | | | | | | | | |
| 17 | 3*nFAW+2*nRRD | repeat Sub-Loop 10, but BA[2:0] = 6 | | | | | | | | | | | | | | | | | |
| 18 | 3*nFAW+3*nRRD | repeat Sub-Loop 11, but BA[2:0] = 7 | | | | | | | | | | | | | | | | | |
| 19 | 3*nFAW+4*nRRD | D | 1 | 0 | 0 | 0 | 0 | 7 | 00 | 0 | 0 | 0 | 0 | 0 | - | | | | |
| | | Assert and repeat above D Command until 4* nFAW - 1, if necessary | | | | | | | | | | | | | | | | | |

a) DM must be driven LOW all the time. DQS, $\overline{\text{DQS}}$ are used according to RD Commands, otherwise MID-LEVEL.

b) Burst Sequence driven on each DQ signal by Read Command. Outside burst operation, DQ signals are MID-LEVEL.

IDD Specifications (Tcase: 0 to 95°C)

* Module IDD values in the datasheet are only a calculation based on the component IDD spec and register power. The actual measurements may vary according to DQ loading cap.

4GB, 512M x 72 R-DIMM: HMT451V7MFR8A

| Symbol | DDR3L 1066 | DDR3L 1333 | Unit | note |
|--------|------------|------------|------|------|
| IDD0 | 1169 | 1169 | mA | |
| IDD1 | 1259 | 1259 | mA | |
| IDD2N | 989 | 989 | mA | |
| IDD2NT | 1034 | 1034 | mA | |
| IDD2P0 | 408 | 408 | mA | |
| IDD2P1 | 426 | 426 | mA | |
| IDD2Q | 989 | 1034 | mA | |
| IDD3N | 1034 | 1079 | mA | |
| IDD3P | 408 | 453 | mA | |
| IDD4R | 1574 | 1709 | mA | |
| IDD4W | 1574 | 1709 | mA | |
| IDD5B | 2024 | 2069 | mA | |
| IDD6 | 408 | 408 | mA | |
| IDD6ET | 426 | 426 | mA | |
| IDD7 | 2069 | 2249 | mA | |

8GB, 1G x 72 R-DIMM: HMT41GV7MFR4A

| Symbol | DDR3L 1066 | DDR3L 1333 | Unit | note |
|--------|------------|------------|------|------|
| IDD0 | 1574 | 1574 | mA | |
| IDD1 | 1754 | 1754 | mA | |
| IDD2N | 1214 | 1214 | mA | |
| IDD2NT | 1304 | 1304 | mA | |
| IDD2P0 | 588 | 588 | mA | |
| IDD2P1 | 624 | 624 | mA | |
| IDD2Q | 1214 | 1304 | mA | |
| IDD3N | 1304 | 1394 | mA | |
| IDD3P | 588 | 678 | mA | |
| IDD4R | 2204 | 2474 | mA | |
| IDD4W | 2204 | 2384 | mA | |
| IDD5B | 3284 | 3374 | mA | |
| IDD6 | 588 | 588 | mA | |
| IDD6ET | 624 | 624 | mA | |
| IDD7 | 3284 | 3644 | mA | |

8GB, 1G x 72 R-DIMM: HMT41GV7MFR8A

| Symbol | DDR3L 1066 | DDR3L 1333 | Unit | note |
|--------|------------|------------|------|------|
| IDD0 | 1394 | 1394 | mA | |
| IDD1 | 1484 | 1484 | mA | |
| IDD2N | 1214 | 1214 | mA | |
| IDD2NT | 1304 | 1304 | mA | |
| IDD2P0 | 588 | 588 | mA | |
| IDD2P1 | 624 | 624 | mA | |
| IDD2Q | 1214 | 1304 | mA | |
| IDD3N | 1304 | 1394 | mA | |
| IDD3P | 588 | 678 | mA | |
| IDD4R | 1799 | 1934 | mA | |
| IDD4W | 1799 | 1934 | mA | |
| IDD5B | 2249 | 2294 | mA | |
| IDD6 | 588 | 588 | mA | |
| IDD6ET | 624 | 624 | mA | |
| IDD7 | 2294 | 2474 | mA | |

16GB, 2G x 72 R-DIMM: HMT82GV7MMR4A

| Symbol | DDR3L 1066 | DDR3L 1333 | Unit | note |
|--------|------------|------------|------|------|
| IDD0 | 2024 | 2024 | mA | |
| IDD1 | 2204 | 2204 | mA | |
| IDD2N | 1664 | 1664 | mA | |
| IDD2NT | 1844 | 1844 | mA | |
| IDD2P0 | 948 | 948 | mA | |
| IDD2P1 | 1020 | 1020 | mA | |
| IDD2Q | 1664 | 1844 | mA | |
| IDD3N | 1844 | 2024 | mA | |
| IDD3P | 948 | 1128 | mA | |
| IDD4R | 2654 | 2924 | mA | |
| IDD4W | 2654 | 2834 | mA | |
| IDD5B | 3734 | 3824 | mA | |
| IDD6 | 948 | 948 | mA | |
| IDD6ET | 1020 | 1020 | mA | |
| IDD7 | 3734 | 4094 | mA | |

16GB, 2G x 72 R-DIMM: HMT82GV7MMR8A

| Symbol | DDR3L 1066 | DDR3L 1333 | Unit | note |
|--------|------------|------------|------|------|
| IDD0 | 1844 | 1844 | mA | |
| IDD1 | 1934 | 1934 | mA | |
| IDD2N | 1664 | 1664 | mA | |
| IDD2NT | 1844 | 1844 | mA | |
| IDD2P0 | 948 | 948 | mA | |
| IDD2P1 | 1020 | 1020 | mA | |
| IDD2Q | 1664 | 1844 | mA | |
| IDD3N | 1844 | 2024 | mA | |
| IDD3P | 948 | 1128 | mA | |
| IDD4R | 2249 | 2384 | mA | |
| IDD4W | 2249 | 2384 | mA | |
| IDD5B | 2699 | 2744 | mA | |
| IDD6 | 948 | 948 | mA | |
| IDD6ET | 1020 | 1020 | mA | |
| IDD7 | 2744 | 2924 | mA | |

Module Dimensions

512Mx72 - HMT451V7MFR8A

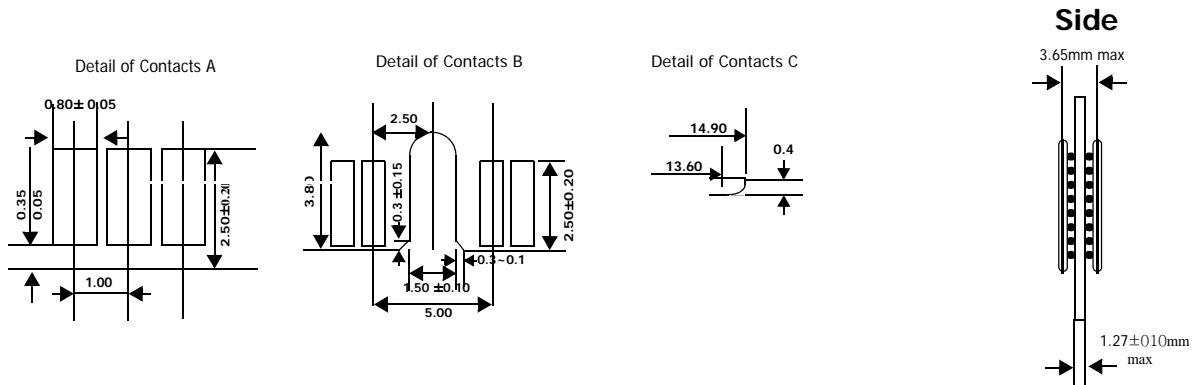
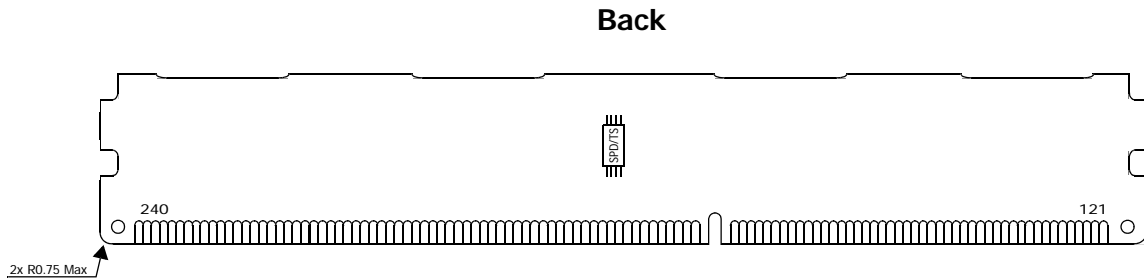
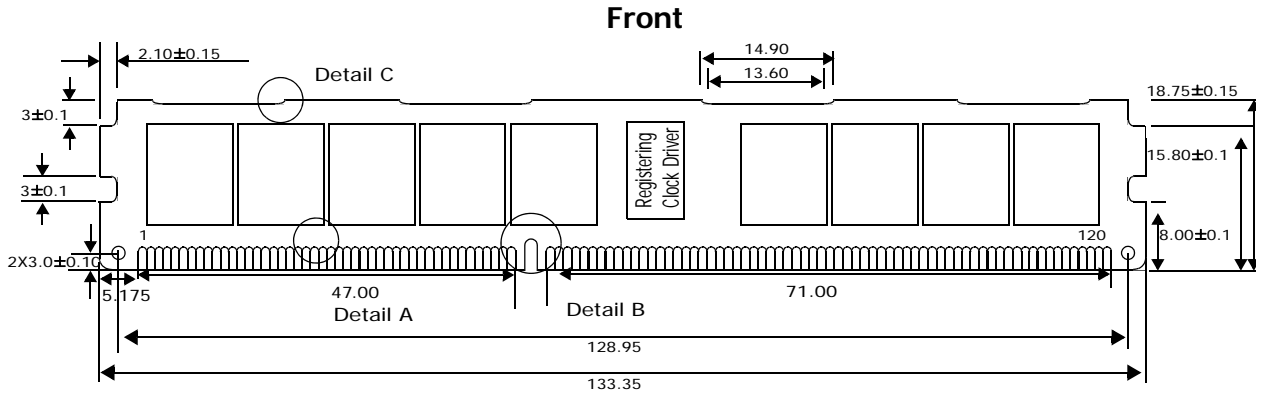

Note:

1. ±0.13 tolerance on all dimensions unless otherwise stated.

Units: millimeters

1Gx72 - HMT41GV7MFR4A

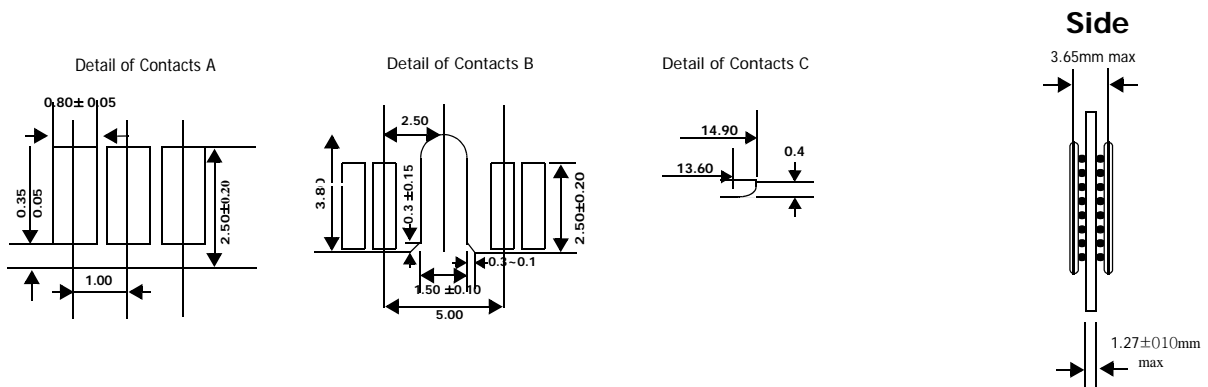
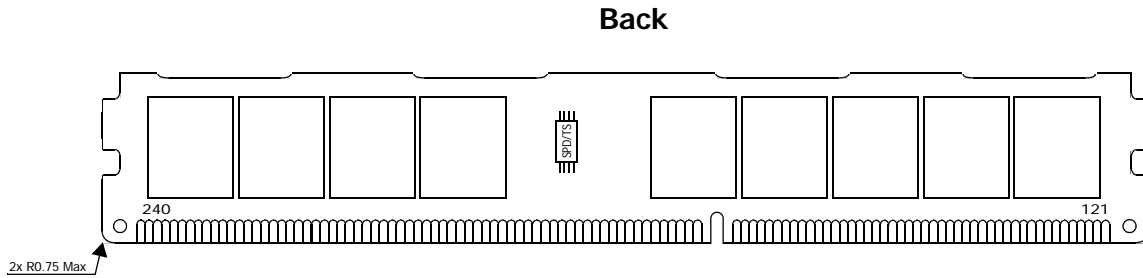
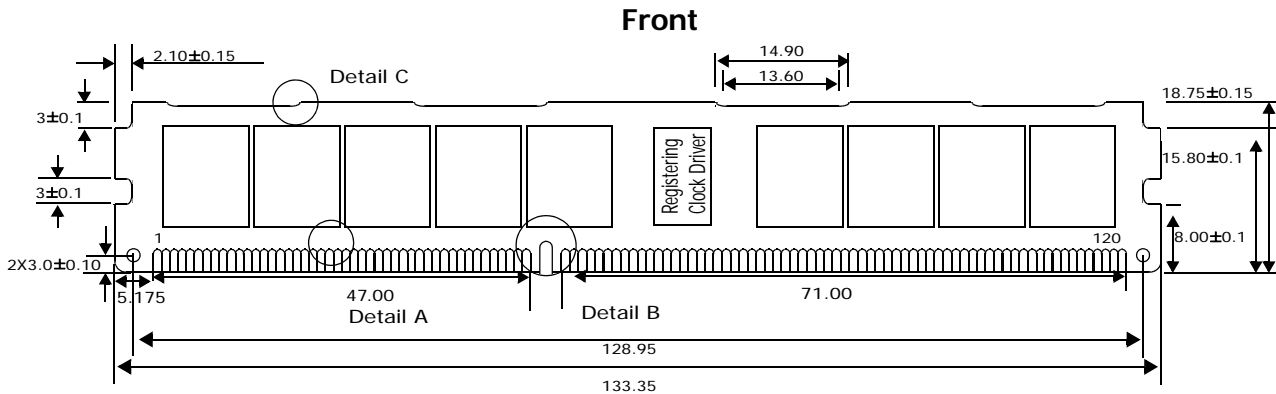

Note:

1. ± 0.13 tolerance on all dimensions unless otherwise stated.

Units: millimeters

1Gx72 - HMT41GV7MFR8A

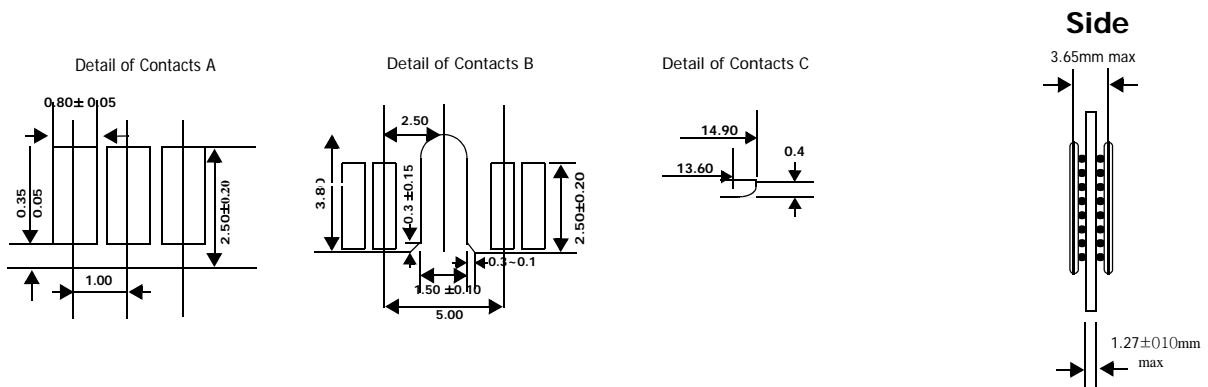
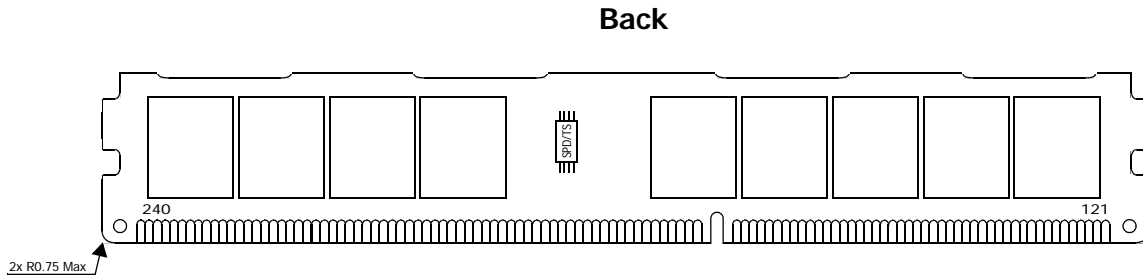
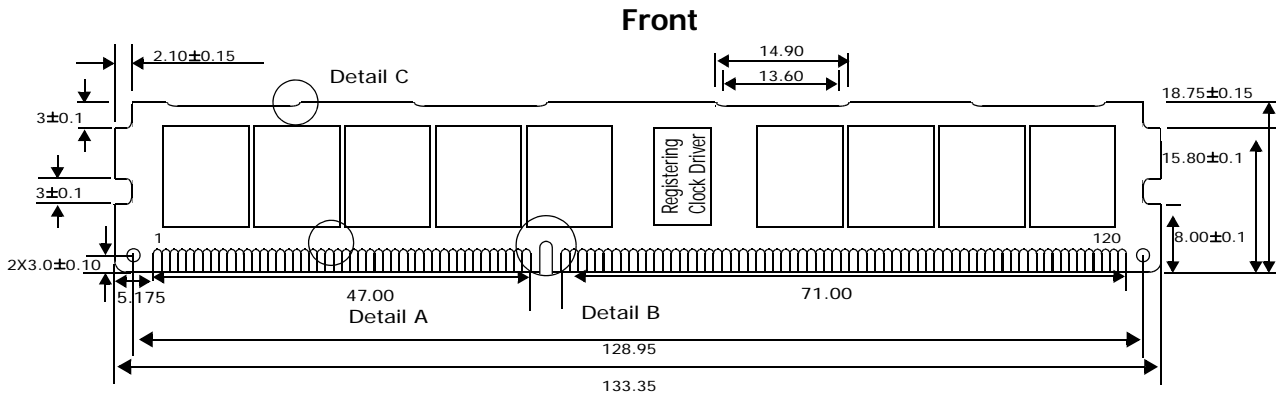

Note:

1. ±0.13 tolerance on all dimensions unless otherwise stated.

Units: millimeters

2Gx72 - HMT82GV7MMR4A

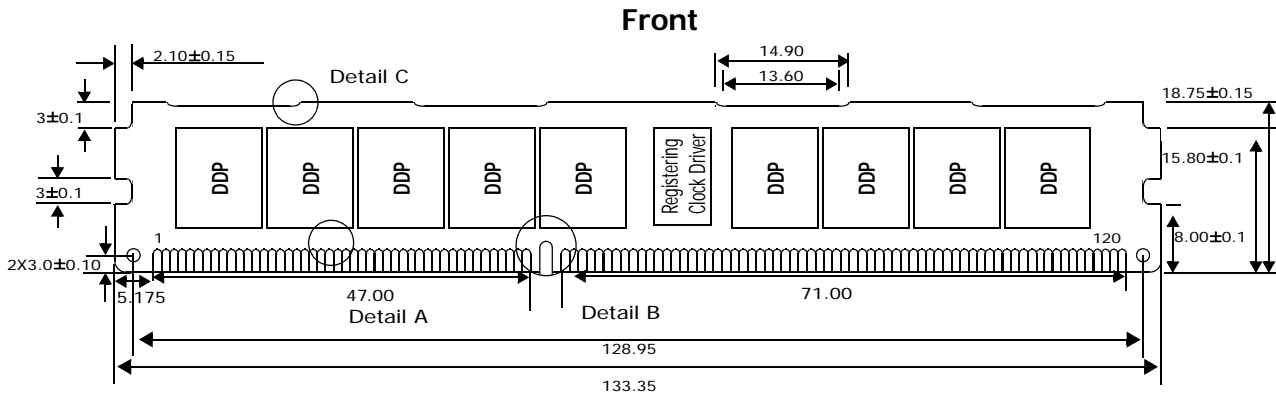

Back

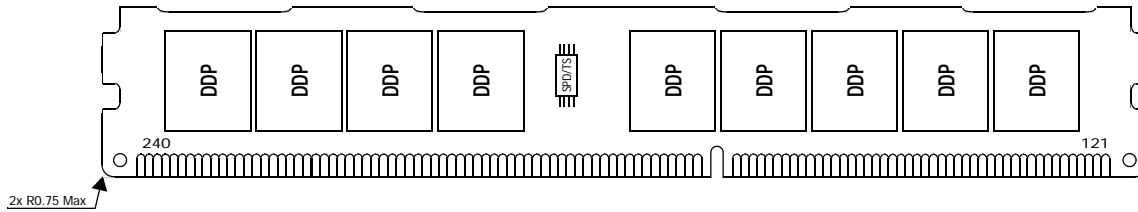

Detail of Contacts A

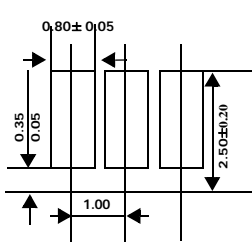

Detail of Contacts B

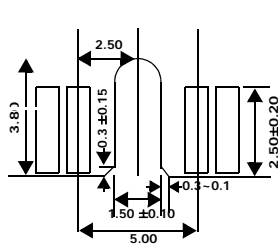

Detail of Contacts C

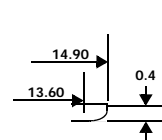

Side

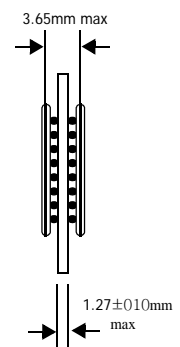

Note:

1. ±0.13 tolerance on all dimensions unless otherwise stated.

Units: millimeters

2Gx72 - HMT82GV7MMR4A - Heat Spreader

Front

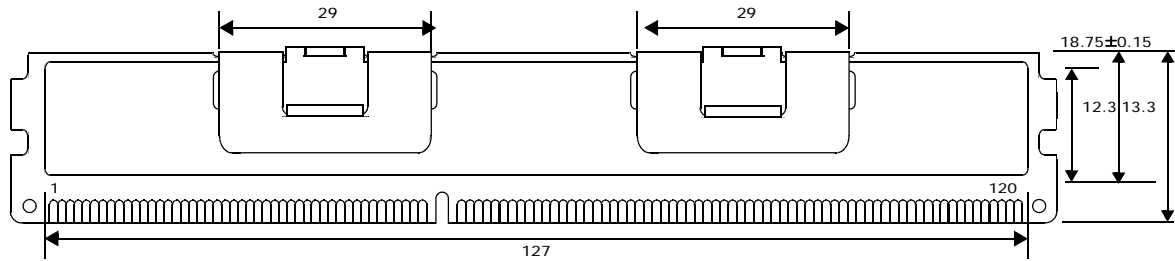

Back

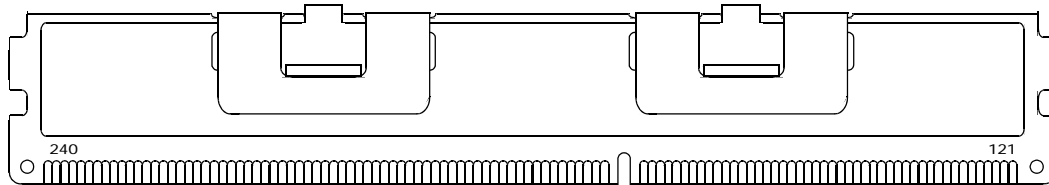

Detail of Contacts A

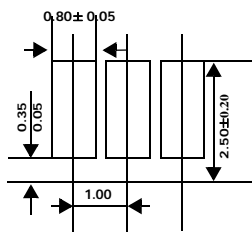

Detail of Contacts B

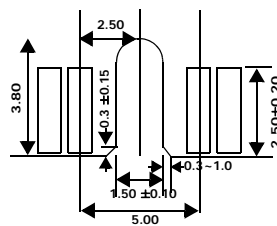

Detail of Contacts C

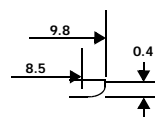

Side

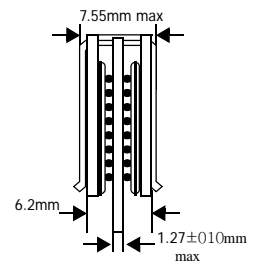

Note:

1. ± 0.13 tolerance on all dimensions unless otherwise stated.
2. In order to uninstall FDHS, please contact sales administrator.

Units: millimeters

2Gx72 - HMT82GV7MMR8A

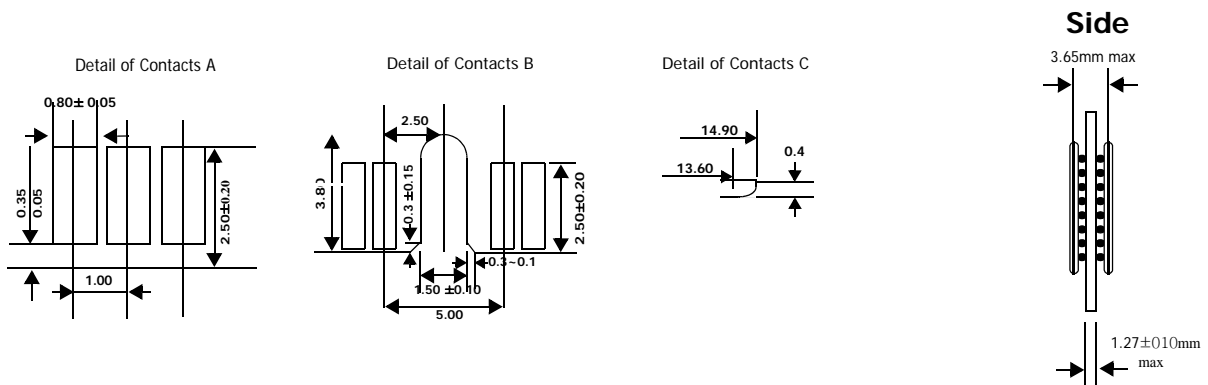
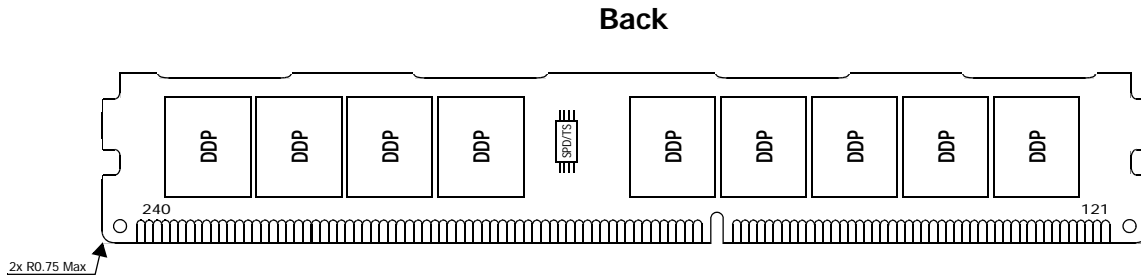
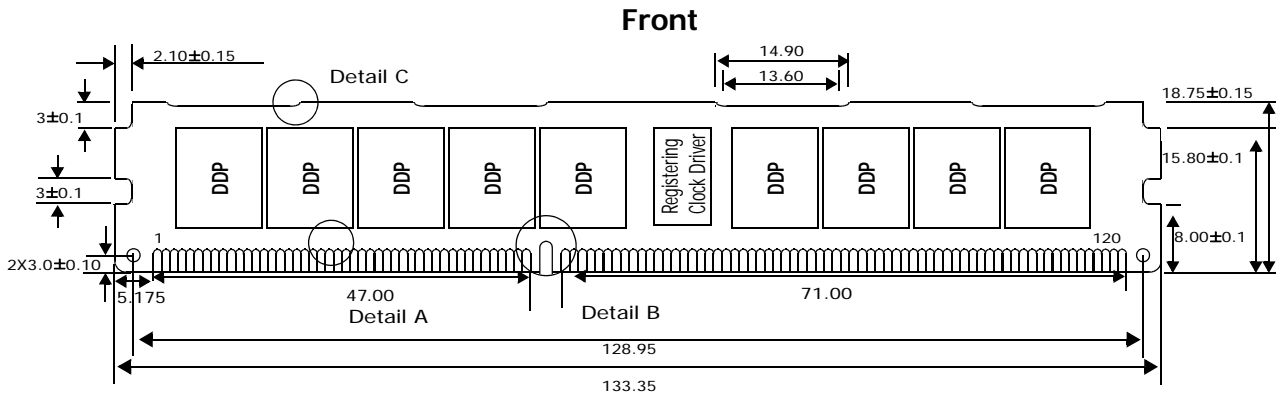

Note:

1. ±0.13 tolerance on all dimensions unless otherwise stated.

Units: millimeters

2Gx72 - HMT82GV7MMR8A - Heat Spreader

Front

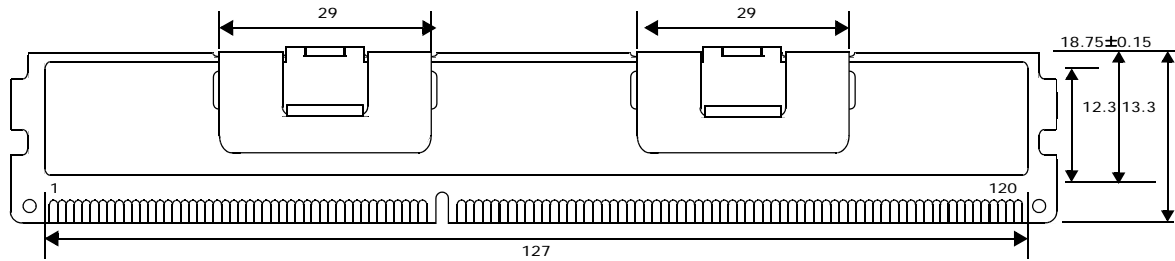

Back

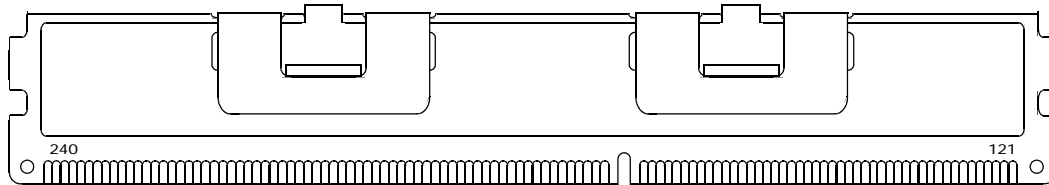

Detail of Contacts A

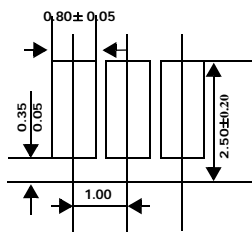

Detail of Contacts B

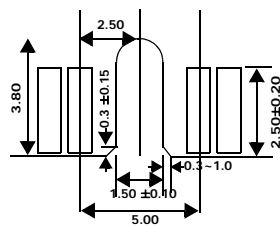

Detail of Contacts C

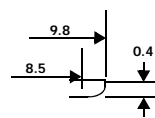

Side

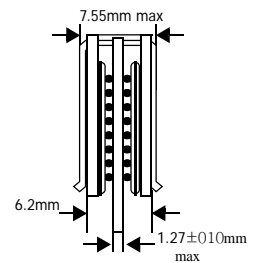

Note:

1. ± 0.13 tolerance on all dimensions unless otherwise stated.
2. In order to uninstall FDHS, please contact sales administrator.

Units: millimeters