

Press Fit SCR ½", 20 Amps

Features

- Improved glass passivation for high reliability
- Exceptional stability at high temperatures
- Metric thread type available
- Low thermal resistance



TO-203/F

Electrical Characteristics ($T_A = 25^\circ\text{C}$ unless otherwise specified)			
Parameter	Symbol	Part Numbers	Units
Maximum repetitive peak reverse voltage, V_{RRM}	50	NPS200	V
	100	NPS201	
	200	NPS202	
	400	NPS204	
	600	NPS206	
RMS on-state current	$I_{T(RMS)}$	20	A
Non-repetitive peak surge on-state current, one cycle	I_{TSM}	200	A
Peak gate trigger current	I_{GTM}	2	A
Peak gate power dissipation @ $I_{GT} \leq I_{GTM}$	P_{GM}	20	W
Average gate power dissipation	$P_{G(AV)}$	0.5	W
Peak off-state current	I_{DRM} & I_{RRM}	1.0	mA
Maximum instantaneous forward voltage drop	V_{TM}	1.9	V
DC holding current	I_H	50	mA
Critical rate-of-rise of off-state voltage	dv/dt	200	V/ μsec
DC gate trigger current	I_{GT}	25	mA
DC gate trigger voltage	V_{GT}	2.0	V
Gate controlled turn-on time	Tgt	2.5	μsec

Thermal and Mechanical Specifications ($T_A = 25^\circ\text{C}$, unless otherwise noted)			
Parameters	Symbol	Values	Units
Maximum operating junction temperature range	T_J	- 40 to +110	$^\circ\text{C}$
Maximum storage temperature range	T_{Stg}	- 40 to +150	$^\circ\text{C}$
Maximum thermal resistance, junction to case	$R_{\theta(j-c)}$	1.3	$^\circ\text{C}/\text{W}$
Approximate weight	W	15	g

Package Outline

(All dimensions in mm)

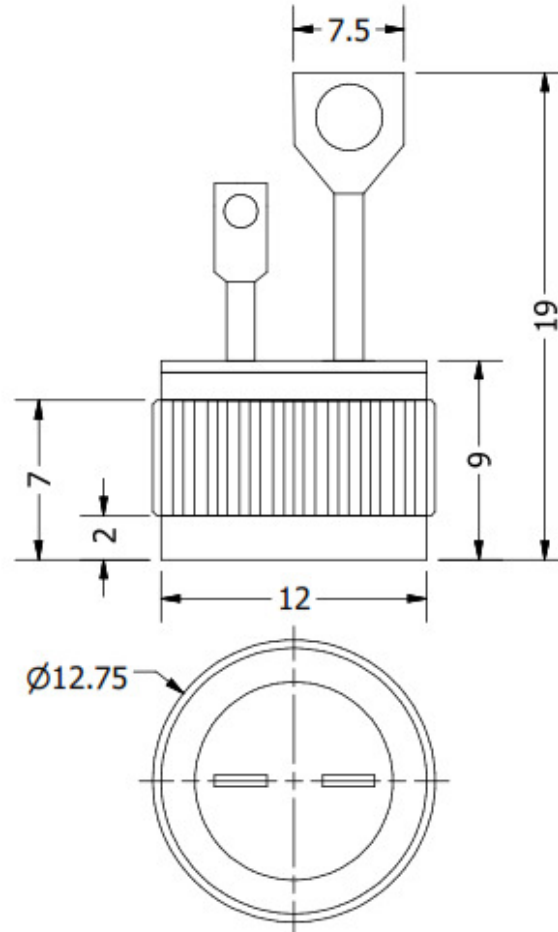

Ordering Table

NPS	20	0,1,2,4,6
1	2	3

- 1 – Press Fit SCR
- 2 – Current, $I_{F(AV)}$
- 3 – Voltage, V_{RRM} (See table)