

PRELIMINARY DATA SHEET

# SKY13402-466LF: 0.4-2.2 GHz GaAs SP10T Switch with MIPI Decoder

## Applications

- 2G/3G multimode cellular handsets (UMTS, CDMA2000, EDGE, GSM)
- Embedded data cards

## Features

- Broadband frequency range: 0.4 to 2.2 GHz
- Single, positive DC power supply (2.5 to 3.3 V)
- Excellent triple beat ratio performance
- Integrated, low-pass harmonic filter for GSM transmit paths
- Integrated MIPI decoder
- Small QFN (26-pin, 2.6 x 3.4 x 0.55 mm) package (MSL1, 260 °C per JEDEC J-STD-020)



**NEW** Skyworks Green™ products are RoHS (Restriction of Hazardous Substances)-compliant, conform to the EIA/EICTA/JEITA Joint Industry Guide (JIG) Level A guidelines, are halogen free according to IEC-61249-2-21, and contain <1,000 ppm antimony trioxide in polymeric materials.

## Description

The SKY13402-466LF is a GaAs pHEMT Single Pole, Ten-Throw (SP10T) antenna switch with an integrated Mobile Industry Processor Interface (MIPI) decoder and dual low-pass harmonic filters. The switch has six transmit/receive ports that make it ideal for any combination of 2G/3G multimode cellular applications.

Using advance switching technologies, the SKY13402-466LF maintains low insertion loss and high isolation for both transmit and receive switching paths. The switch also exhibits an excellent triple beat ratio and 2<sup>nd</sup>/3<sup>rd</sup> order modulation distortion performance.

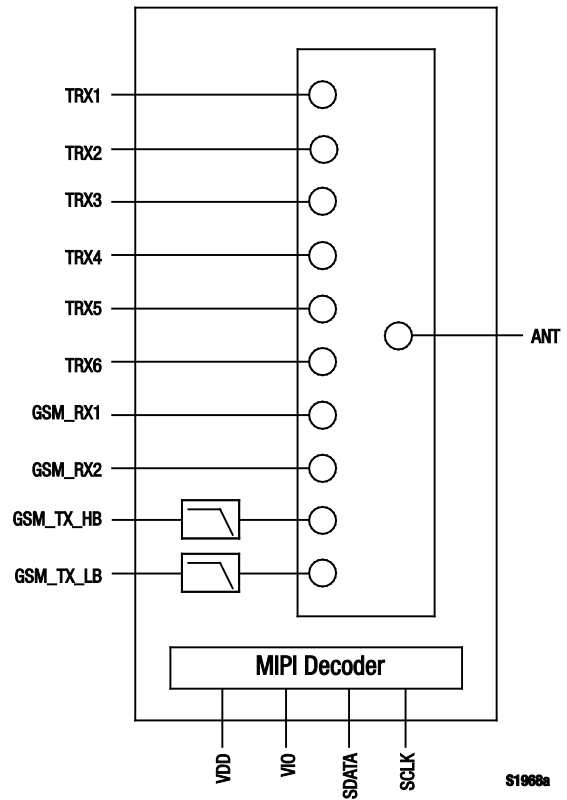

**Figure 1. SKY13402-466LF Block Diagram**

Switching is controlled by an integrated MIPI decoder. The VIO signal (pin 23) enables and disables the decoder. The SDATA and SCLK signals (pins 24 and 25, respectively) clock in the data to the decoder. Depending on the logic applied to the decoder, the antenna pin is connected to one of ten switched RF ports using a low insertion loss path, while the paths between the antenna pin and the other RF pins are in a high isolation state. No external DC blocking capacitors are required on the RF paths.

The SKY13402-466LF is manufactured in a compact, 2.6 x 3.4 x 0.55 mm, 26-pin Quad Flat No-Lead (QFN) package.

A functional block diagram is shown in Figure 1. The pin configuration and package are shown in Figure 2. Signal pin assignments and functional pin descriptions are provided in Table 1.

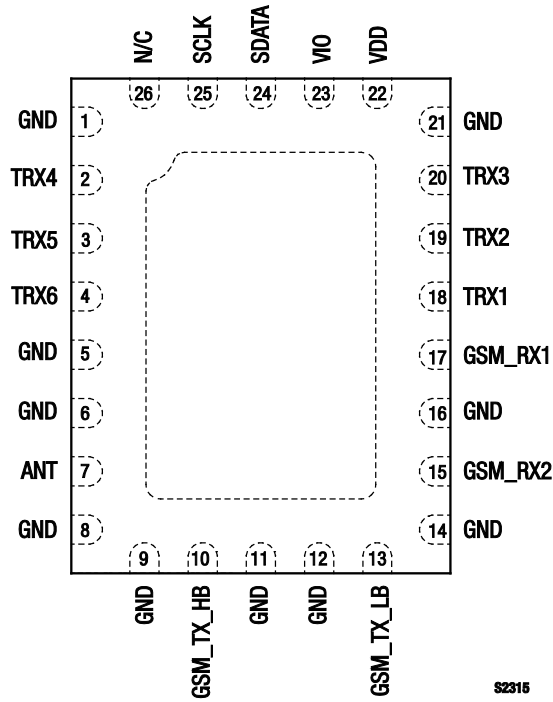

Figure 2. SKY13402-466LF Pinout – 26-Pin QFN (Top View)

Table 1. SKY13402-466LF Signal Descriptions

Pin #	Name	Description	Pin #	Name	Description
1	GND	Ground	14	GND	Ground
2	TRX4	RF input/output port 4	15	GSM_RX2	GSM RF output port 2
3	TRX5	RF input/output port 5	16	GND	Ground
4	TRX6	RF input/output port 6	17	GSM_RX1	GSM RF output port 1
5	GND	Ground	18	TRX1	RF input/output port 1
6	GND	Ground	19	TRX2	RF input/output port 2
7	ANT	Antenna RF port	20	TRX3	RF input/output port 3
8	GND	Ground	21	GND	Ground
9	GND	Ground	22	VDD	DC power supply
10	GSM_TX_HB	GSM high band transmit RF input port with integrated harmonic filter	23	VIO	MIPI decoder enable
11	GND	Ground	24	SDATA	Serial data input
12	GND	Ground	25	SCLK	Clock input
13	GSM_TX_LB	GSM low band transmit RF input port with integrated harmonic filter	26	N/C	No connection. Pin may be connected to ground with no change in performance.

Note: Bottom ground paddles must be connected to ground.

**Table 2. SKY13402-466LF Absolute Maximum Ratings**

Parameter	Symbol	Minimum	Maximum	Units
RF input power	$P_{IN}$		+36	dBm
Power supply			5	V
Interface supply	$V_{IO}$		1.9	V
Storage temperature	$T_{STG}$	-40	+125	°C
Operating temperature	$T_{OP}$	-30	+90	°C

**Note:** Exposure to maximum rating conditions for extended periods may reduce device reliability. There is no damage to device with only one parameter set at the limit and all other parameters set at or below their nominal value. Exceeding any of the limits listed here may result in permanent damage to the device.

---

**CAUTION:** Although this device is designed to be as robust as possible, Electrostatic Discharge (ESD) can damage this device. This device must be protected at all times from ESD. Static charges may easily produce potentials of several kilovolts on the human body or equipment, which can discharge without detection. Industry-standard ESD precautions should be used at all times.

---

## Electrical and Mechanical Specifications

The absolute maximum ratings of the SKY13402-466LF are provided in Table 2. Electrical specifications are provided in Table 3.

Typical performance characteristics of the SKY13402-466LF are illustrated in Figures 3 to 19.

The MIPI interface is programmed serially according to the logic shown in Tables 4, 5, and 6.

Figure 20 illustrates the test setup used to measure data for Figure 17. This industry standardized test is used to simulate the

WCDMA Band 1 linearity of the antenna switch. A +20 dBm Continuous Wave (CW) signal,  $f_{FUND}$ , is sequentially applied to the TRX1 through TRX6 ports, while a -15 dBm CW blocker signal,  $f_{BLK}$ , is applied to the ANT port.

The resulting 3<sup>rd</sup> Order Intermodulation Distortion (IMD3),  $f_{RX}$ , is measured over all phases of  $f_{FUND}$ . The SKY13402-466LF exhibits exceptional performance for all TRX ports.

**Table 3. SKY13402-466LF Electrical Specifications (Note 1) (1 of 2)**

(V<sub>DD</sub> = 2.65 V, V<sub>1</sub> = V<sub>2</sub> = V<sub>3</sub> = V<sub>4</sub> = 0/1.8 V, T<sub>OP</sub> = +25 °C, P<sub>IN</sub> = 0 dBm, Characteristic Impedance [Z<sub>0</sub>] = 50 Ω, Unless Otherwise Noted)

Parameter	Symbol	Test Condition	Min	Typical	Max	Units
<b>RF Specifications</b>						
Insertion loss: ANT to TRX1/2/3 ports	IL	824 to 960 MHz		0.5	0.7	dB
		1710 to 2170 MHz		0.6	0.8	dB
		2300 to 2690 MHz		0.9	1.1	dB
Insertion loss: ANT to TRX4/5/6 ports	IL	824 to 960 MHz		0.50	0.70	dB
		1710 to 2170 MHz		0.65	0.85	dB
		2300 to 2690 MHz		0.90	1.10	dB
Insertion loss: ANT to GSM_TX_LB port	IL	824 to 915 MHz		1.35	1.55	dB
Insertion loss: ANT to GSM_TX_HB port	IL	1710 to 1910 MHz		1.2	1.4	dB
Insertion loss: ANT to GSM_RX1/2/3 ports	IL	869 to 960 MHz		0.8	1.0	dB
		1805 to 1990 MHz		1.0	1.2	dB
Isolation (TRX1/2/3 to TRX4/5/6 ports)	ISO	824 to 1910 MHz	32	35		dB
Isolation (GSM_TX_LB to TRX1/2/3/4/5/6 and GSM_RX1/2 ports)	ISO	824 to 915 MHz	30	33		dB
Isolation (GSM_TX_HB to TRX1/2/3/4/5/6 and GSM_RX1/2 ports)	ISO	1710 to 1910 MHz	32	35		dB
Isolation (TRX4 to TRX6 port)	ISO	824 to 1910 MHz	25	28		dB
Isolation (TRX1 to TRX2, TRX2 to TRX3, TRX4 to TRX5, TRX5 to TRX6 ports)	ISO	824 to 1910 MHz	18	21		dB
Isolation (ANT to GSM_RX2 ports)	ISO	1805 to 1990 MHz	30	33		dB
Harmonics		UMTS, P <sub>IN</sub> = +27 dBm		-48	-36	dBm
		GSM_TX_LB port, P <sub>IN</sub> = +35 dBm		-45	-36	dBm
		GSM_TX_HB port, P <sub>IN</sub> = +33 dBm		-44	-36	dBm
Attenuation (GSM_TX_LB port)		GSM850				
		2f	18	22	dB	
		3f	25	28	dB	
		>4f	17	20	dB	
		EGSM900				
		2f	22	25	dB	
3f	22	25	dB			
>4f	17	20	dB			
Attenuation (GSM_TX_HB port)		DCS1800				
		2f	20	25	dB	
		3f	25	28	dB	
		>4f	17	20	dB	
		PCS1900				
		2f	22	25	dB	
3f	25	28	dB			
>4f	17	20	dB			
Return loss	IS111	0.4 to 2.2 GHz	14	18		dB

**Table 3. SKY13402-466LF Electrical Specifications (Note 1) (2 of 2)**

( $V_{DD} = 2.65\text{ V}$ ,  $V_1 = V_2 = V_3 = V_4 = 0/1.8\text{ V}$ ,  $T_{OP} = +25\text{ }^\circ\text{C}$ ,  $P_{IN} = 0\text{ dBm}$ , Characteristic Impedance [ $Z_0$ ] =  $50\ \Omega$ , Unless Otherwise Noted)

Parameter	Symbol	Test Condition	Min	Typical	Max	Units
<b>RF Specifications (continued)</b>						
2 <sup>nd</sup> Order Input Intercept Point	IIP2	AWS, PCS, IMT to CDMA2000 modes	+95.5			dBm
2 <sup>nd</sup> Order Intermodulation Distortion	IMD2	UMTS mode		-105	-97	dBm
3 <sup>rd</sup> Order Intermodulation Distortion	IMD3	UMTS mode		-105	-97	dBm
Triple Beat Ratio	TBR	650 to 900 MHz		81		dBc
		1710 to 2155 MHz		81		dBc
1 dB Input Compression Point	IP1dB	GSM_TX_LB port, 824 to 915 MHz	+40			dBm
		GSM_TX_HB port, 1710 to 1910 MHz	+39			dBm
Switching speed		10/90% RF		3	5	$\mu\text{s}$
<b>DC Specifications</b>						
Supply voltage	$V_{DD}$		2.50	2.65	3.30	V
Supply current	$I_{DD}$			0.4	0.5	mA
Control voltage:	V1, V2, V3, V4					
High		1.35	1.80	3.10	V	
Low		0		0.3	V	
Control current:						
High				10	$\mu\text{A}$	
Low				5	$\mu\text{A}$	

**Note 1:** Performance is guaranteed only under the conditions listed in this Table.

**Typical Performance Characteristics**

( $V_{DD} = 2.65\text{ V}$ ,  $V_1 = V_2 = V_3 = V_4 = 0/1.8\text{ V}$ ,  $T_{OP} = +25\text{ }^\circ\text{C}$ ,  $P_{IN} = 0\text{ dBm}$ , Characteristic Impedance [ $Z_0$ ] =  $50\ \Omega$ , Unless Otherwise Noted)

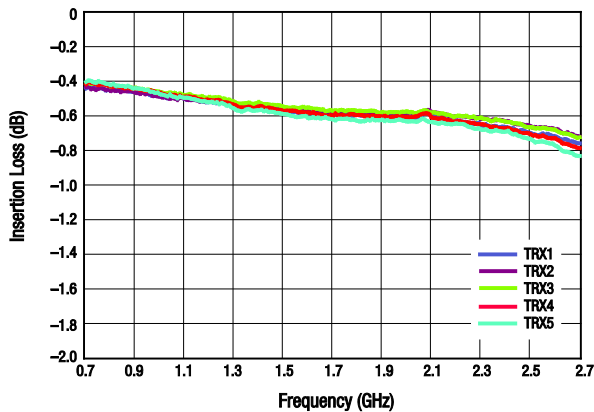

**Figure 3. Insertion Loss vs Frequency (ANT to TRX Ports)**

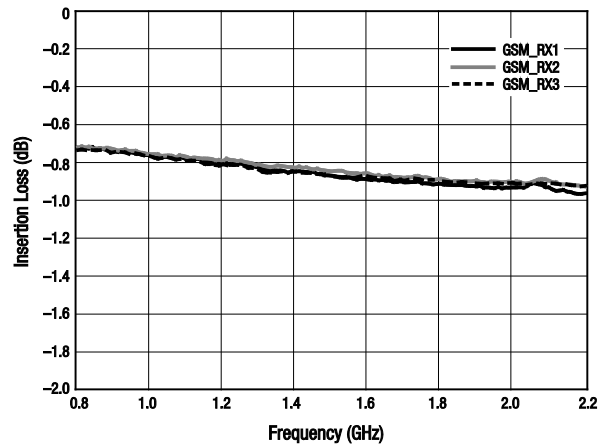

**Figure 4. Insertion Loss vs Frequency (ANT to GSM\_RX Ports)**

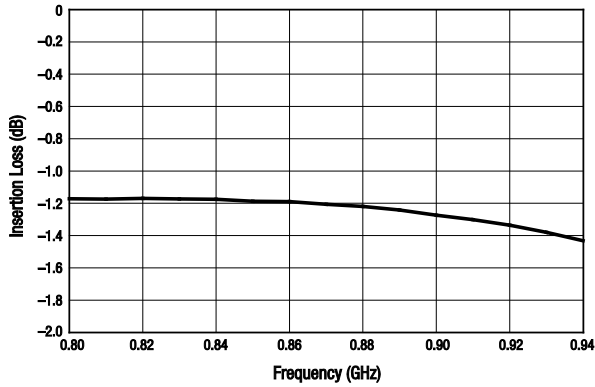

**Figure 5. Insertion Loss vs Frequency (ANT to GSM\_TX\_LB Port)**

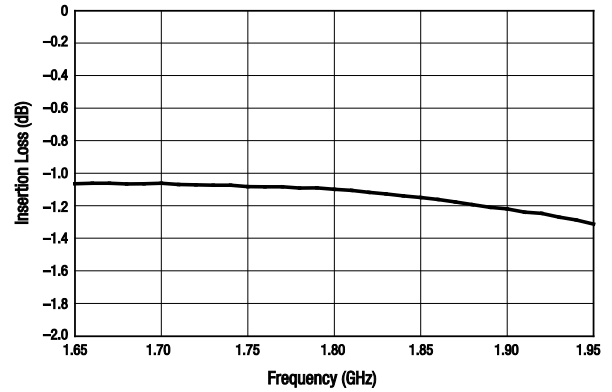

**Figure 6. Insertion Loss vs Frequency (ANT to GSM\_TX\_HB Port)**

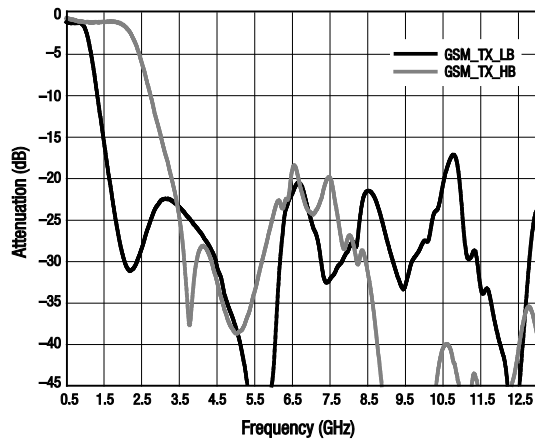

**Figure 7. Attenuation vs Frequency (ANT to GSM\_TX\_HB/LB Ports)**

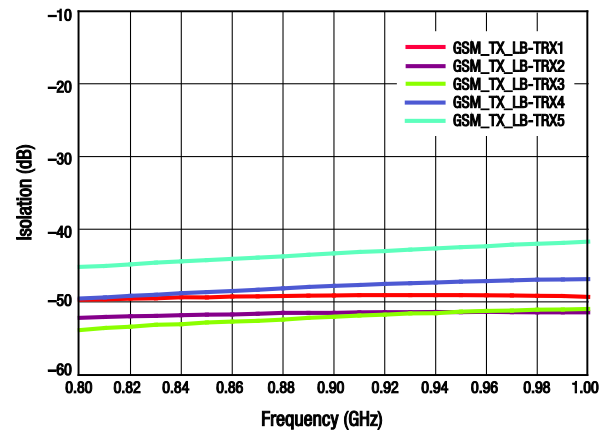

**Figure 8. Isolation vs Frequency (GSM\_TX\_LB to TRX Ports)**

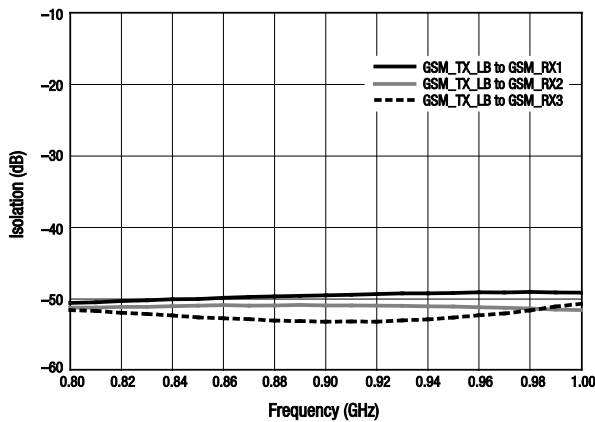

**Figure 9. Isolation vs Frequency (GSM\_TX\_LB to GSM\_RX1/2 Ports)**

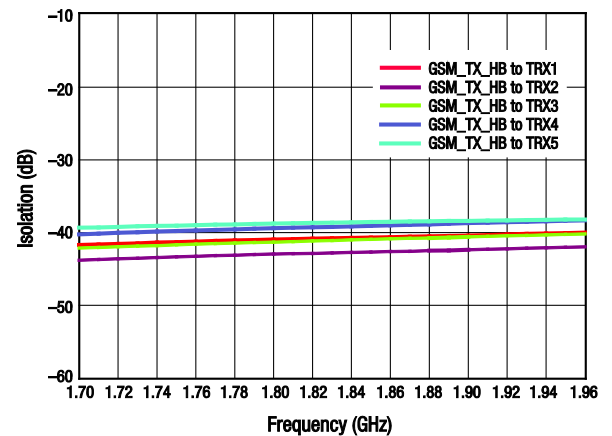

**Figure 10. Isolation vs Frequency (GSM\_TX\_HB to TRX Ports)**

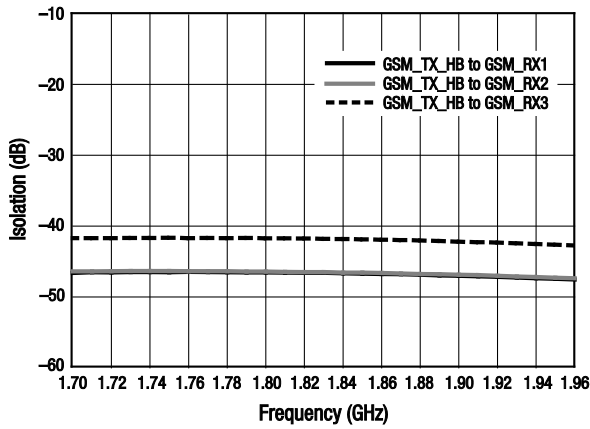

**Figure 11. Isolation vs Frequency (GSM\_TX\_HB to GSM\_RX1/2 Ports)**

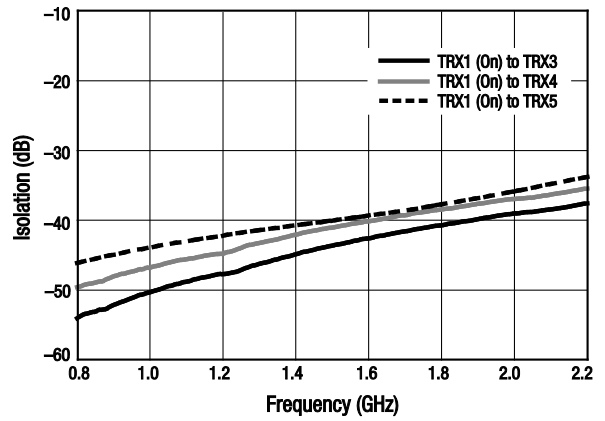

**Figure 12. Isolation vs Frequency (TRX1 to TRX4/5/6 Ports)**

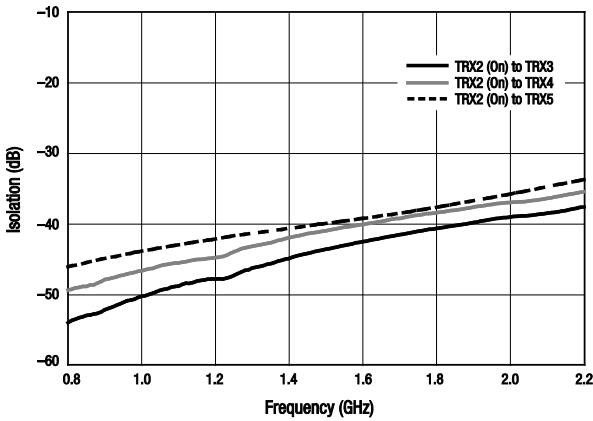

**Figure 13. Isolation vs Frequency (TRX2 to TRX4/5/6 Ports)**

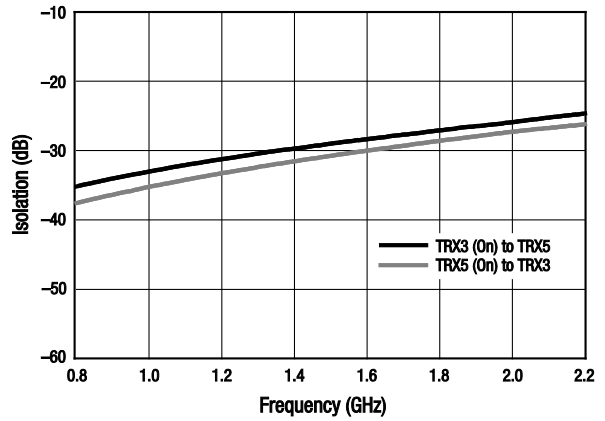

**Figure 14. Isolation vs Frequency (TRX3 to TRX5 Port)**

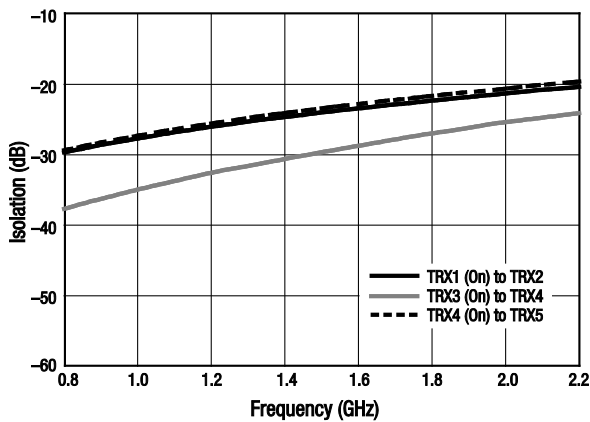

**Figure 15. Isolation vs Frequency (TRX Adjacent Ports)**

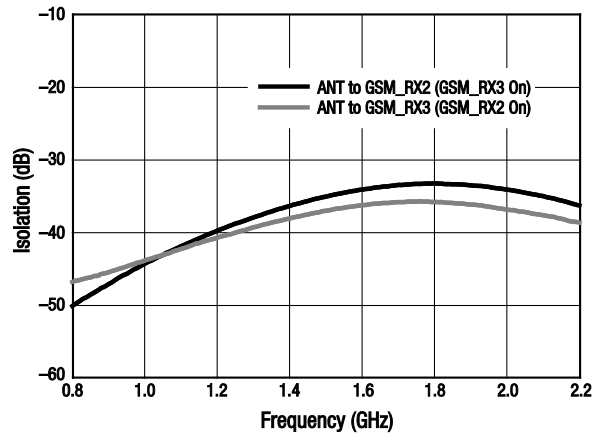

**Figure 16. Isolation vs Frequency (ANT to GSM\_RX1/2 Ports)**

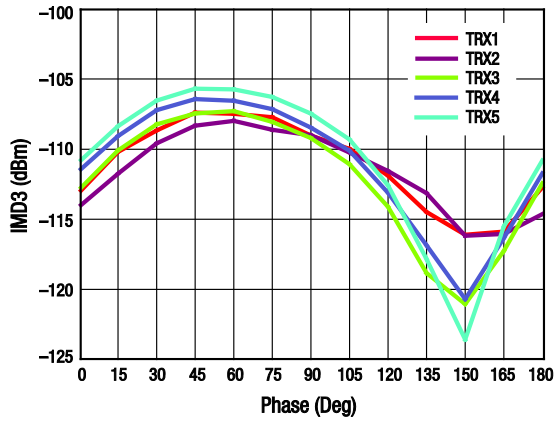

**Figure 17. 3<sup>rd</sup> Order Intermodulation Distortion vs Phase, TRX Ports (f<sub>FUND</sub> = 1.95 GHz, f<sub>BLK</sub> = 1.76 GHz, f<sub>RX</sub> = 2.14 GHz)**

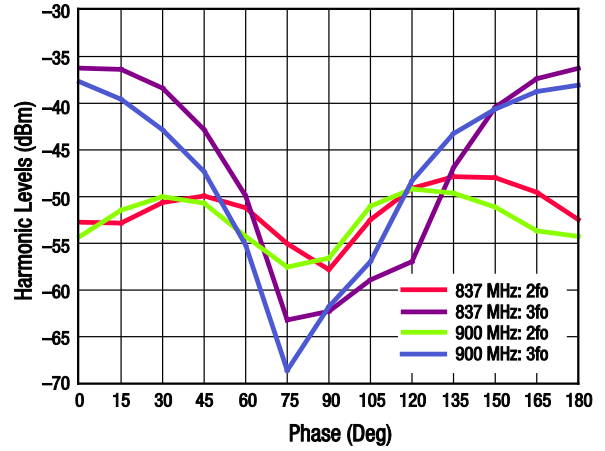

**Figure 18. Harmonics vs Phase (ANT to GSM\_TX\_LB, P<sub>IN</sub> = +35 dBm, 5:1 VSWR Mismatch)**

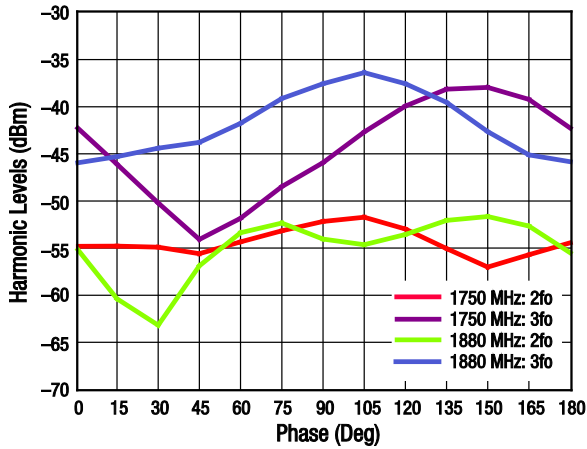

**Figure 19. Harmonics vs Phase (ANT to GSM\_TX\_HB, P<sub>IN</sub> = +33 dBm, 5:1 VSWR Mismatch)**



**Table 4. MIPI Interface Insertion Loss Logic, Register 0x01 (Note 1)**

Insertion Loss State	SDATA Signal (Pin 24)			
	Bit 3	Bit 2	Bit 1	Bit 0
ANT to GSM_TX_LB	0	0	0	1
ANT to GSM_TX_HB	0	0	1	0
ANT to GSM_RX1	1	1	0	0
ANT to GSM_RX2	1	1	0	1
ANT to TRX1	0	1	0	0
ANT to TRX2	0	1	0	1
ANT to TRX3	0	1	1	0
ANT to TRX4	1	0	0	0
ANT to TRX5	1	0	0	1
ANT to TRX6	1	0	1	0
Power off (low current)	0	0	0	0
Isolation	1	1	1	1

**Note 1:** “1” =  $(0.8 \times VIO - VIO)$ ; “0” =  $(0 - 0.2 \times VIO)$ . Any state other than that described in this Table places the switch into an undefined state. An undefined state will not damage the device.

**Table 5. MIPI Interface Unique Slave Identifier (USID) Logic**

USID	SDATA Signal (Pin 24)			
	Bit 3	Bit 2	Bit 1	Bit 0
	1	0	1	1

**Table 6. MIPI Interface Skyworks Product ID (P\_ID) Logic, Register 0x1D**

P_ID	SDATA Signal (Pin 24)							
	Bit 7	Bit 6	Bit 5	Bit 4	Bit 3	Bit 2	Bit 1	Bit 0
Skyworks	0	0	1	1	0	0	0	0

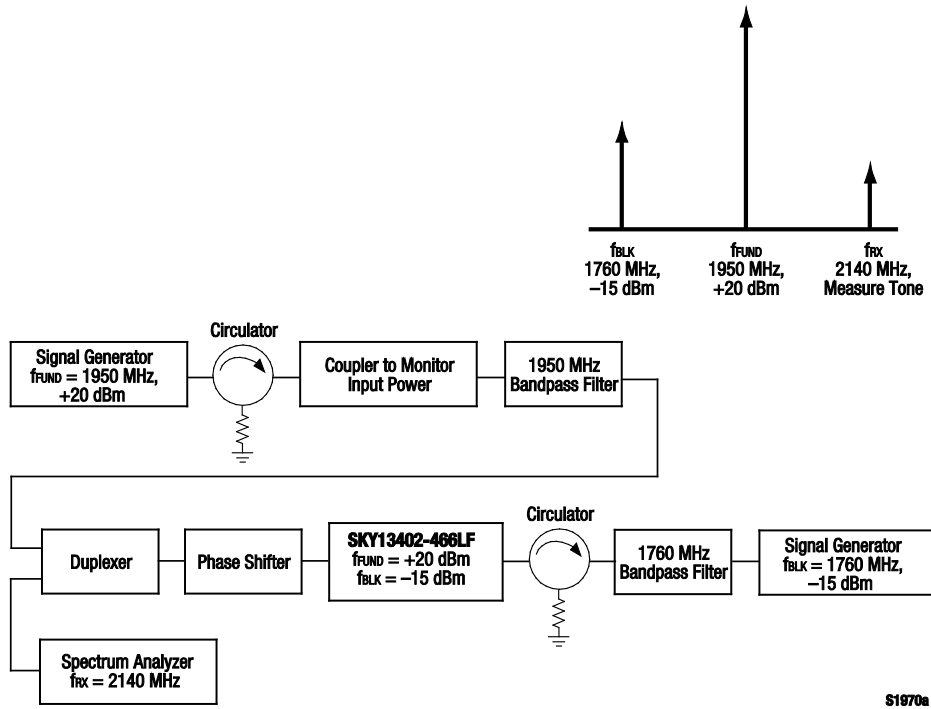

Figure 20. 3<sup>rd</sup> Order Intermodulation Test Setup

### Evaluation Board Description

The SKY13402-466LF Evaluation Board is used to test the performance of the SKY13402-466LF SP10T Switch. An Evaluation Board schematic diagram is provided in Figure 21. An assembly drawing for the Evaluation Board is shown in Figure 22.

### Package Dimensions

The PCB layout footprint for the SKY13402-466LF is provided in Figure 23. Typical case markings are shown in Figure 24. Package dimensions for the 26-pin QFN are shown in Figure 25, and tape and reel dimensions are provided in Figure 26.

### Package and Handling Information

Instructions on the shipping container label regarding exposure to moisture after the container seal is broken must be followed. Otherwise, problems related to moisture absorption may occur when the part is subjected to high temperature during solder assembly.

THE SKY13402-466LF is rated to Moisture Sensitivity Level 1 (MSL1) at 260 °C. It can be used for lead or lead-free soldering. For additional information, refer to the Skyworks Application Note, *Solder Reflow Information*, document number 200164.

Care must be taken when attaching this product, whether it is done manually or in a production solder reflow environment. Production quantities of this product are shipped in a standard tape and reel format.

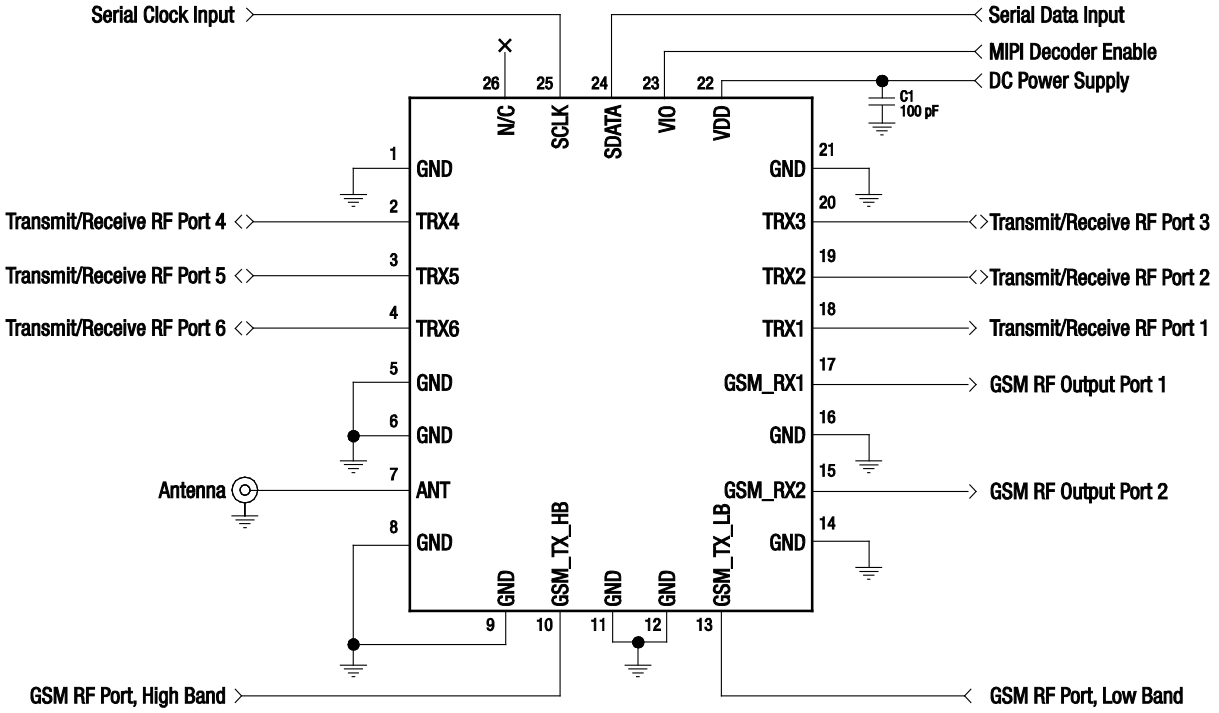

S1971a

Figure 21. SKY13402-466LF Evaluation Board Schematic

\*\*\* TBD \*\*\*

**Figure 22. SKY13402-466LF Evaluation Board Assembly Diagram**

\*\*\* TBD \*\*\*

**Figure 23. SKY13402-466LF PCB Layout Footprint  
(Top View)**

\*\*\* TBD \*\*\*

**Figure 24. Typical Part Markings  
(Top View)**

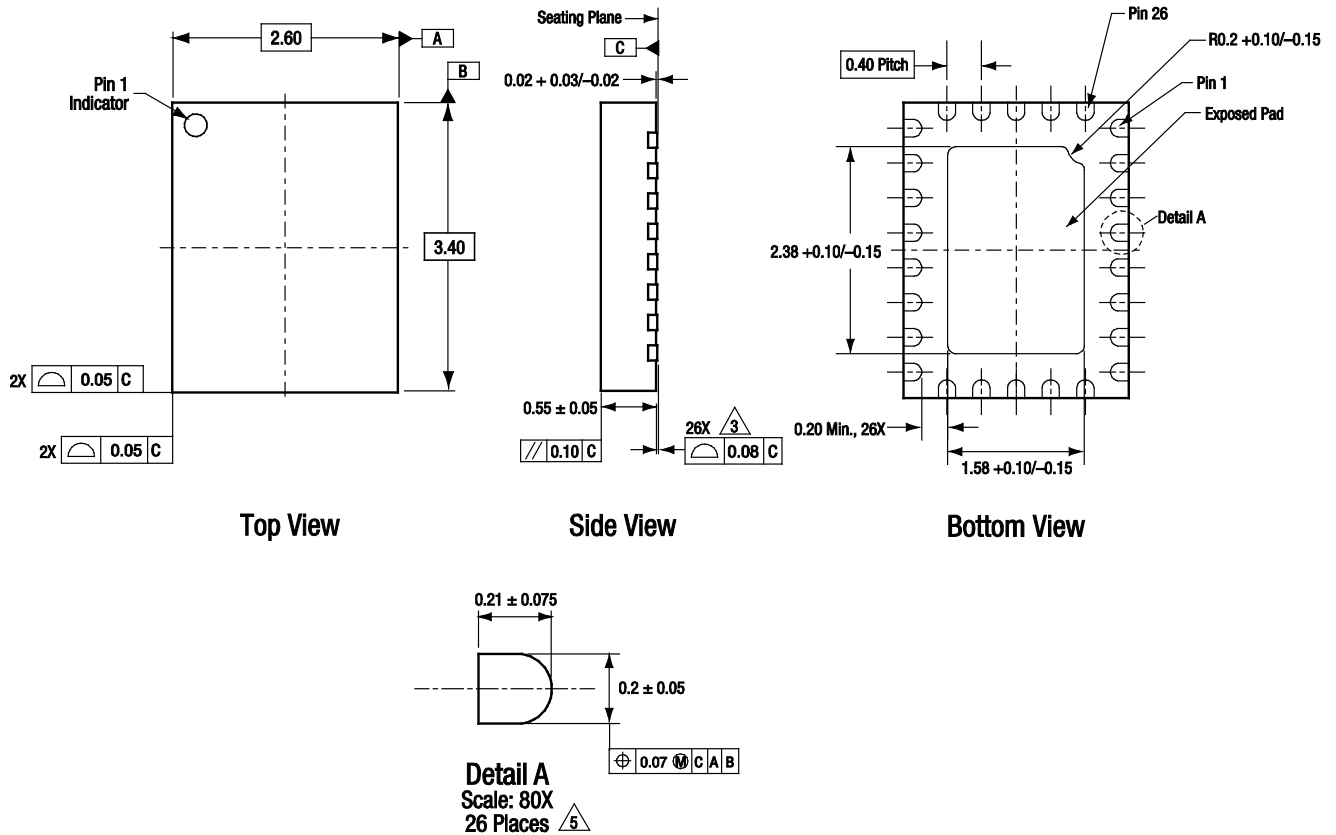

All measurements are in millimeters.  
 Dimensioning and tolerancing according to ASME Y14.5M-1994.  
 Coplanarity applies to the exposed bottom surface metalization, as well as the terminals.  
 Plating requirement per source control drawing (SCD) 2504.

S2314

Figure 25. SKY13402-466LF 26-Pin QFN Package Dimensions

\*\*\* TBD \*\*\*

**Figure 26. SKY13402-466LF Tape and Reel Dimensions**

## Ordering Information

Model Name	Manufacturing Part Number	Evaluation Board Part Number
SKY13402-466LF 0.4-2.2 GHz SP10T Switch	SKY13402-466LF	SKY13402-466LF-EVB

Copyright © 2011 Skyworks Solutions, Inc. All Rights Reserved.

Information in this document is provided in connection with Skyworks Solutions, Inc. ("Skyworks") products or services. These materials, including the information contained herein, are provided by Skyworks as a service to its customers and may be used for informational purposes only by the customer. Skyworks assumes no responsibility for errors or omissions in these materials or the information contained herein. Skyworks may change its documentation, products, services, specifications or product descriptions at any time, without notice. Skyworks makes no commitment to update the materials or information and shall have no responsibility whatsoever for conflicts, incompatibilities, or other difficulties arising from any future changes.

No license, whether express, implied, by estoppel or otherwise, is granted to any intellectual property rights by this document. Skyworks assumes no liability for any materials, products or information provided hereunder, including the sale, distribution, reproduction or use of Skyworks products, information or materials, except as may be provided in Skyworks Terms and Conditions of Sale.

THE MATERIALS, PRODUCTS AND INFORMATION ARE PROVIDED "AS IS" WITHOUT WARRANTY OF ANY KIND, WHETHER EXPRESS, IMPLIED, STATUTORY, OR OTHERWISE, INCLUDING FITNESS FOR A PARTICULAR PURPOSE OR USE, MERCHANTABILITY, PERFORMANCE, QUALITY OR NON-INFRINGEMENT OF ANY INTELLECTUAL PROPERTY RIGHT; ALL SUCH WARRANTIES ARE HEREBY EXPRESSLY DISCLAIMED. SKYWORKS DOES NOT WARRANT THE ACCURACY OR COMPLETENESS OF THE INFORMATION, TEXT, GRAPHICS OR OTHER ITEMS CONTAINED WITHIN THESE MATERIALS. SKYWORKS SHALL NOT BE LIABLE FOR ANY DAMAGES, INCLUDING BUT NOT LIMITED TO ANY SPECIAL, INDIRECT, INCIDENTAL, STATUTORY, OR CONSEQUENTIAL DAMAGES, INCLUDING WITHOUT LIMITATION, LOST REVENUES OR LOST PROFITS THAT MAY RESULT FROM THE USE OF THE MATERIALS OR INFORMATION, WHETHER OR NOT THE RECIPIENT OF MATERIALS HAS BEEN ADVISED OF THE POSSIBILITY OF SUCH DAMAGE.

Skyworks products are not intended for use in medical, lifesaving or life-sustaining applications, or other equipment in which the failure of the Skyworks products could lead to personal injury, death, physical or environmental damage. Skyworks customers using or selling Skyworks products for use in such applications do so at their own risk and agree to fully indemnify Skyworks for any damages resulting from such improper use or sale.

Customers are responsible for their products and applications using Skyworks products, which may deviate from published specifications as a result of design defects, errors, or operation of products outside of published parameters or design specifications. Customers should include design and operating safeguards to minimize these and other risks. Skyworks assumes no liability for applications assistance, customer product design, or damage to any equipment resulting from the use of Skyworks products outside of stated published specifications or parameters.

Skyworks, the Skyworks symbol, and "Breakthrough Simplicity" are trademarks or registered trademarks of Skyworks Solutions, Inc., in the United States and other countries. Third-party brands and names are for identification purposes only, and are the property of their respective owners. Additional information, including relevant terms and conditions, posted at [www.skyworksinc.com](http://www.skyworksinc.com), are incorporated by reference.