

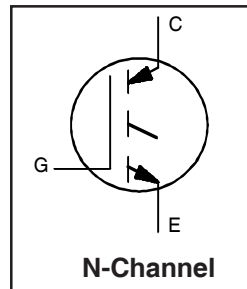
# IRG4MC40U

INSULATED GATE BIPOLAR TRANSISTOR

UltraFast Speed IGBT

## Features

- Electrically Isolated and Hermetically Sealed
- Simple Drive Requirements
- Latch-proof
- UltraFast Speed Operation 8KHz - 40KHz, > 200KHz in Resonant Mode
- High Operating Frequency
- Switching-loss Rating includes all "tail" Losses
- Ceramic Eyelets

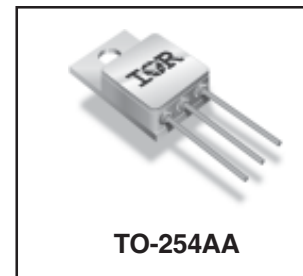


$V_{CES} = 600V$
$V_{CE(on)max} = 2.1V$
@ $V_{GE} = 15V, I_C = 20A$

## Benefits

- Generation 4 IGBTs offer highest efficiency available
- IGBT's optimized for specified application conditions
- Designed to be a "drop-in" replacement for equivalent IR A&D Generation 3 IGBTs

Insulated Gate Bipolar Transistors (IGBTs) from International Rectifier have higher usable current densities than comparable bipolar transistors, while at the same time having simpler gate-drive requirements of the familiar power MOSFET. They provide substantial benefits to a host of high-voltage, high-current applications.



TO-254AA

## Absolute Maximum Ratings

	Parameter	Max.	Units
$V_{CES}$	Collector-to-Emitter Breakdown Voltage	600	V
$I_C @ T_C = 25^\circ C$	Continuous Collector Current	35*	A
$I_C @ T_C = 100^\circ C$	Continuous Collector Current	20	
$I_{CM}$	Pulsed Collector Current $\text{\textcircled{D}}$	140	
$I_{LM}$	Clamped Inductive Load Current $\text{\textcircled{D}}$	140	
$V_{GE}$	Gate-to-Emitter Voltage	$\pm 20$	V
$P_D @ T_C = 25^\circ C$	Maximum Power Dissipation	114	W
$P_D @ T_C = 100^\circ C$	Maximum Power Dissipation	45	
$T_J$ $T_{STG}$	Operating Junction and Storage Temperature Range	-55 to + 150	$^\circ C$
	Lead Temperature	300 (0.063in./1.6mm from case for 10s)	
	Weight	9.3 (typical)	

\* Current is limited by package

## Thermal Resistance

	Parameter	Min	Typ	Max	Units	Test Conditions
$R_{thJC}$	Junction-to-Case	—	—	1.1	$^\circ C/W$	

## Electrical Characteristics @ $T_J = 25^\circ\text{C}$ (unless otherwise specified)

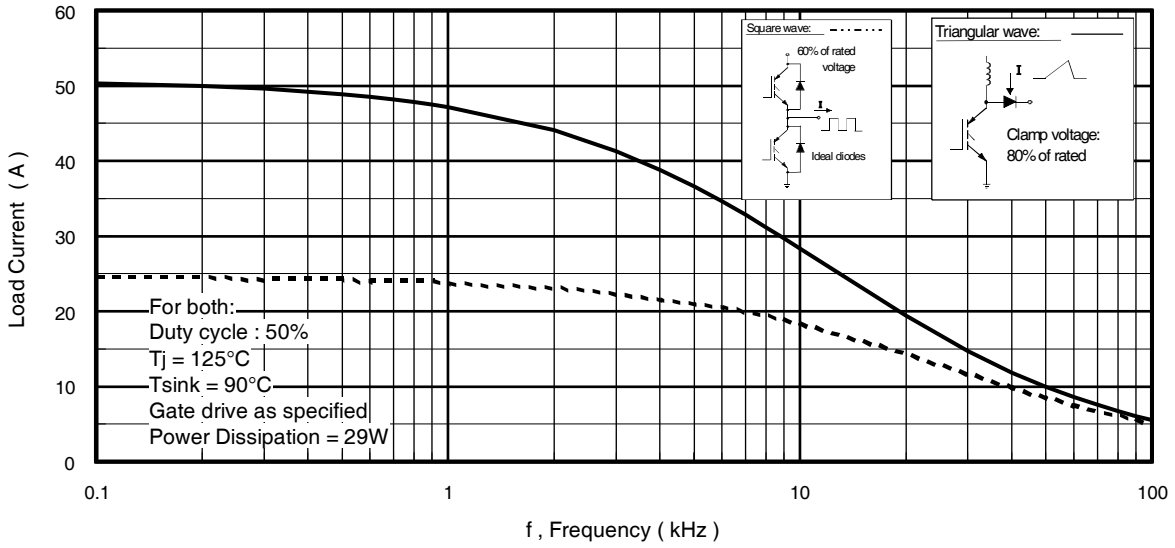
	Parameter	Min.	Typ.	Max.	Units	Conditions
$V_{(BR)CES}$	Collector-to-Emitter Breakdown Voltage	600	—	—	V	$V_{GE} = 0V, I_C = 1.0\text{ mA}$
$V_{(BR)ECS}$	Emitter-to-Collector Breakdown Voltage <sup>③</sup>	17	—	—	V	$V_{GE} = 0V, I_C = 1.0\text{ A}$
$\Delta V_{(BR)CES}/\Delta T_J$	Temperature Coeff. of Breakdown Voltage	—	0.5	—	V/°C	$V_{GE} = 0V, I_C = 1.0\text{ mA}$
$V_{CE(ON)}$	Collector-to-Emitter Saturation Voltage	—	—	2.1	V	$I_C = 20A$ $V_{GE} = 15V$ See Fig.2, 5
		—	—	2.5		
		—	—	2.1		
$V_{GE(th)}$	Gate Threshold Voltage	3.0	—	6.0		$V_{CE} = V_{GE}, I_C = 1.0\text{ mA}$
$\Delta V_{GE(th)}/\Delta T_J$	Temperature Coeff. of Threshold Voltage	—	-12	—	mV/°C	$V_{CE} = V_{GE}, I_C = 250\text{ }\mu\text{A}$
$g_{fe}$	Forward Transconductance <sup>④</sup>	11	—	—	S	$V_{CE} \geq 15V, I_C = 20A$
$I_{CES}$	Zero Gate Voltage Collector Current	—	—	50	$\mu\text{A}$	$V_{GE} = 0V, V_{CE} = 480V$
		—	—	2000		$V_{GE} = 0V, V_{CE} = 480V, T_J = 125^\circ\text{C}$
$I_{GES}$	Gate-to-Emitter Leakage Current	—	—	$\pm 100$	nA	$V_{GE} = \pm 20V$

## Switching Characteristics @ $T_J = 25^\circ\text{C}$ (unless otherwise specified)

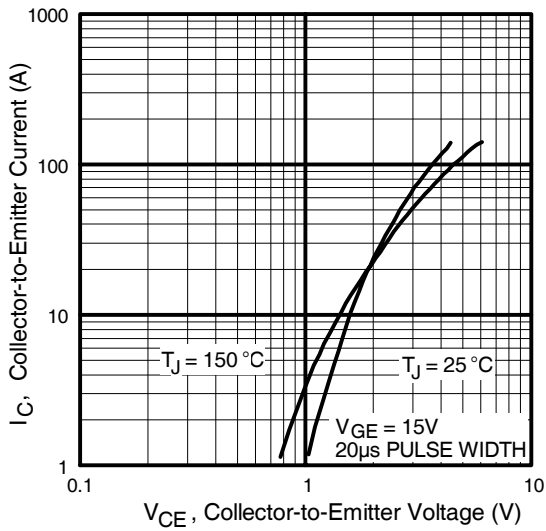
	Parameter	Min.	Typ.	Max.	Units	Conditions
$Q_g$	Total Gate Charge (turn-on)	—	—	150	nC	$I_C = 20A$ $V_{CC} = 300V$ See Fig. 8 $V_{GE} = 15V$
$Q_{ge}$	Gate - Emitter Charge (turn-on)	—	—	25		
$Q_{gc}$	Gate - Collector Charge (turn-on)	—	—	60		
$t_{d(on)}$	Turn-On Delay Time	—	—	50	ns	$T_J = 25^\circ\text{C}$ $I_C = 20A, V_{CC} = 480V$ $V_{GE} = 15V, R_G = 9.1\Omega$ Energy losses include "tail"
$t_r$	Rise Time	—	—	42		
$t_{d(off)}$	Turn-Off Delay Time	—	—	190		
$t_f$	Fall Time	—	—	150		
$E_{ts}$	Total Switching Loss	—	—	1.0	mJ	See Fig. 10, 11, 13, 14
$t_{d(on)}$	Turn-On Delay Time	—	—	40	ns	$T_J = 125^\circ\text{C}$ , $I_C = 20A, V_{CC} = 480V$ $V_{GE} = 15V, R_G = 9.1\Omega$ Energy losses include "tail"
$t_r$	Rise Time	—	—	40		
$t_{d(off)}$	Turn-Off Delay Time	—	—	300		
$t_f$	Fall Time	—	—	250		
$E_{ts}$	Total Switching Loss	—	—	1.8	mJ	See Fig. 13, 14
$L_C+L_E$	Total Inductance	—	6.8	—	nH	Measured from Collector lead (6mm/ 0.25in. from package) to Emitter lead (6mm / 0.25in. from package)
$C_{ies}$	Input Capacitance	—	2215	—	pF	$V_{GE} = 0V$ $V_{CC} = 30V$ See Fig. 7 $f = 1.0\text{ MHz}$
$C_{oes}$	Output Capacitance	—	135	—		
$C_{res}$	Reverse Transfer Capacitance	—	25	—		

### Notes:

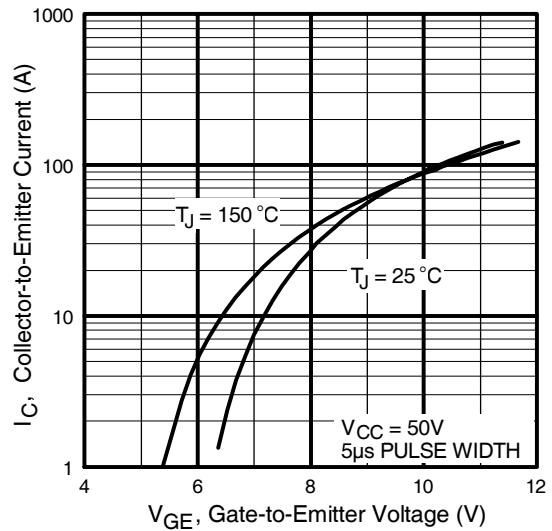
- ① Repetitive rating;  $V_{GE} = 20V$ , pulse width limited by max. junction temperature. (See Fig.13b)
- ②  $V_{CC} = 80\%(V_{CES})$ ,  $V_{GE} = 20V$ ,  $L = 100\mu\text{H}$ ,  $R_G = 9.1\Omega$ , (See Fig.13a)
- ③ Pulse width  $\leq 80\mu\text{s}$ ; duty factor  $\leq 0.1\%$ .
- ④ Pulse width  $5.0\mu\text{s}$ , single shot.



**Fig. 1 - Typical Load Current vs. Frequency**  
 (For square wave,  $I = I_{\text{RMS}}$  of fundamental; for triangular wave,  $I = I_{\text{PK}}$ )

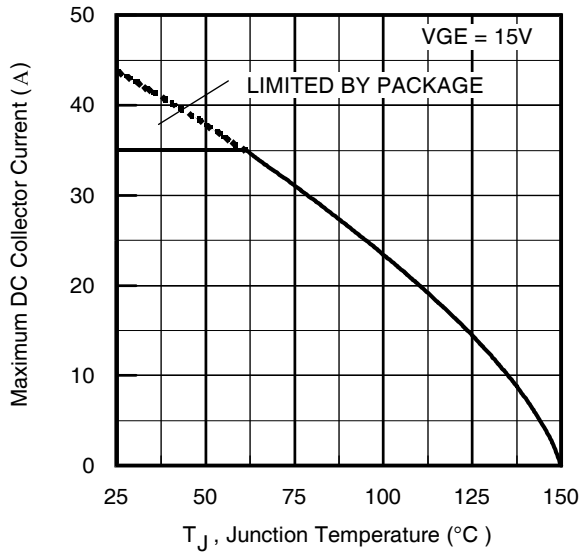


**Fig. 2 - Typical Output Characteristics**

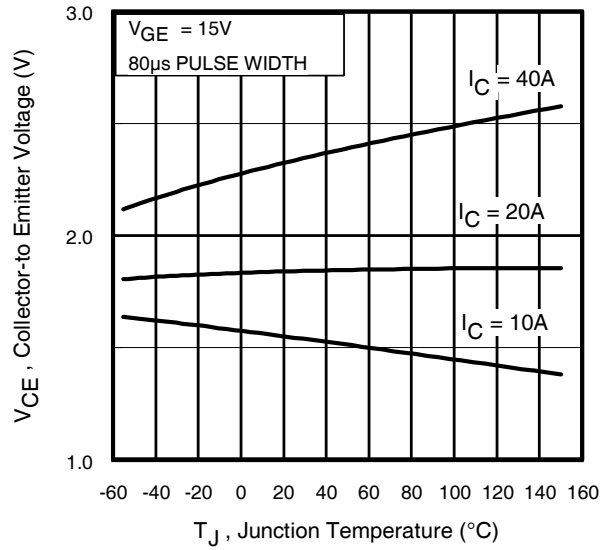


**Fig. 3 - Typical Transfer Characteristics**

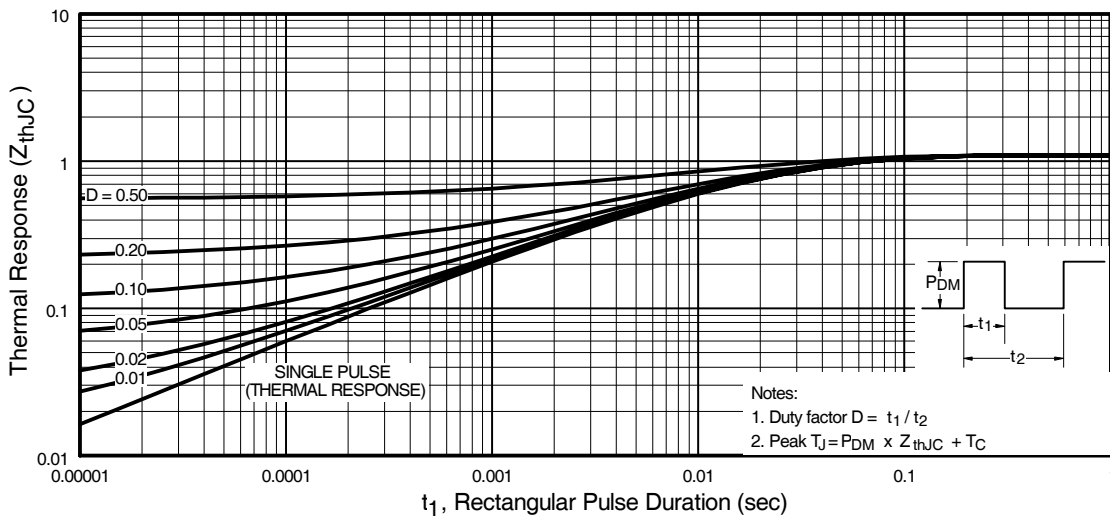
# IRG4MC40U



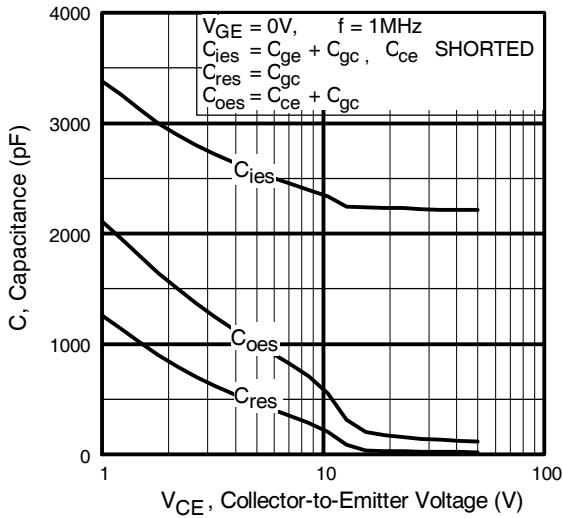
**Fig. 4** - Maximum Collector Current vs. Case Temperature



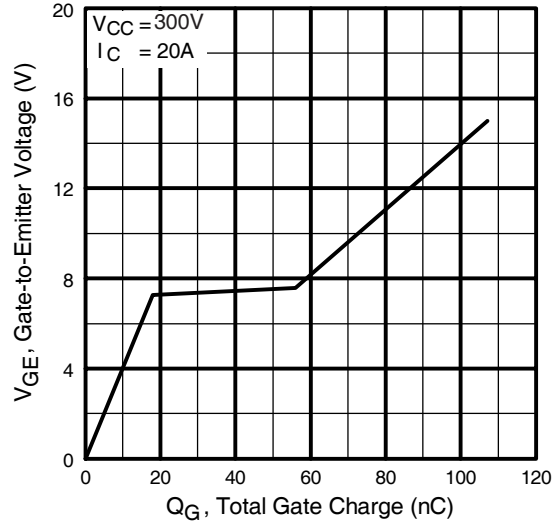
**Fig. 5** - Collector-to-Emitter Voltage vs. Junction Temperature



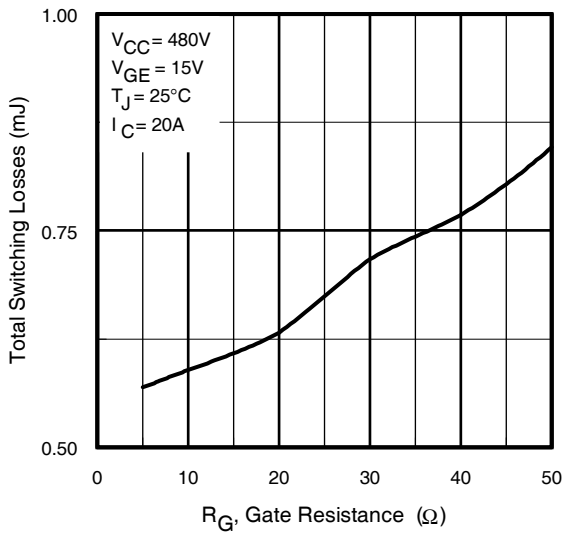
**Fig. 6** - Maximum Effective Transient Thermal Impedance, Junction-to-Case



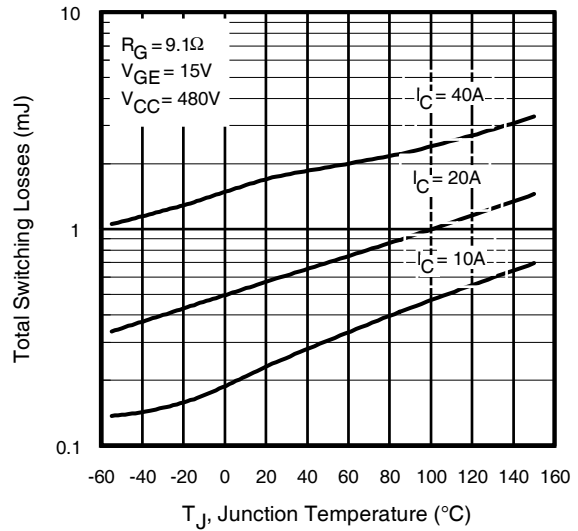
**Fig. 7** - Typical Capacitance vs. Collector-to-Emitter Voltage



**Fig. 8** - Typical Gate Charge vs. Gate-to-Emitter Voltage



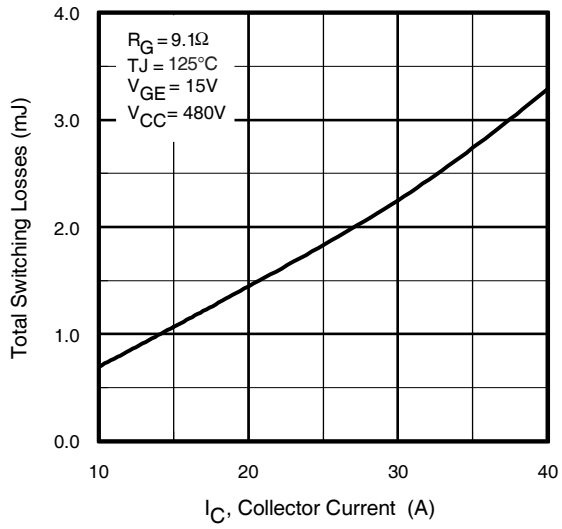
**Fig. 9** - Typical Switching Losses vs. Gate Resistance



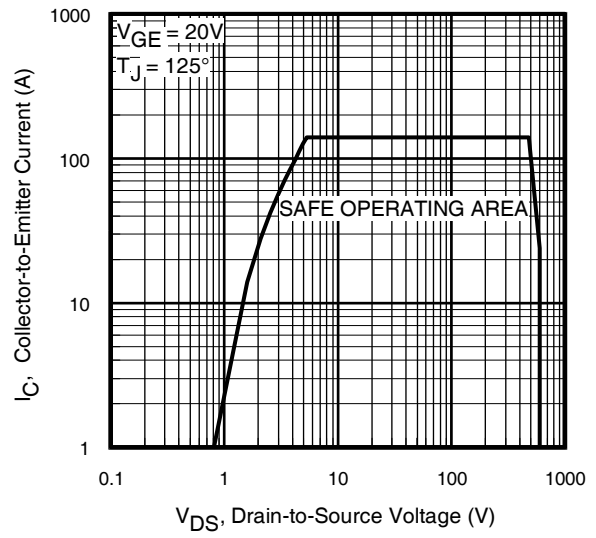
**Fig. 10** - Typical Switching Losses vs. Junction Temperature

# IRG4MC40U

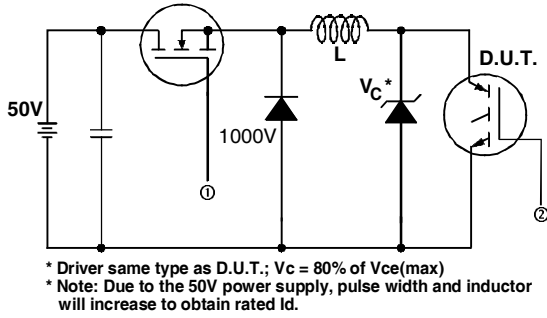
International  
**IR** Rectifier



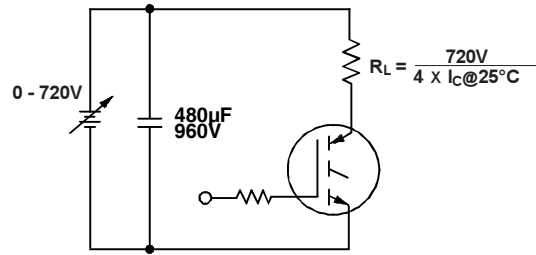
**Fig. 11** - Typical Switching Losses vs. Collector-to-Emitter Current



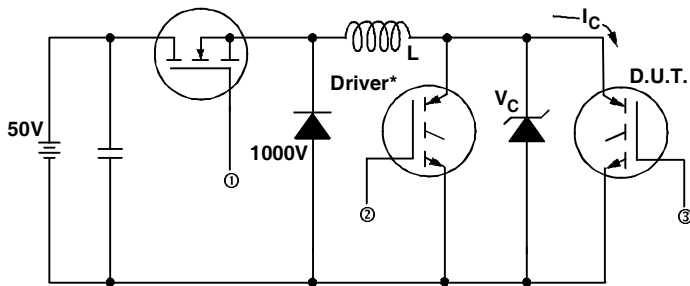
**Fig. 12** - Turn-Off SOA



**Fig. 13a** - Clamped Inductive Load Test Circuit

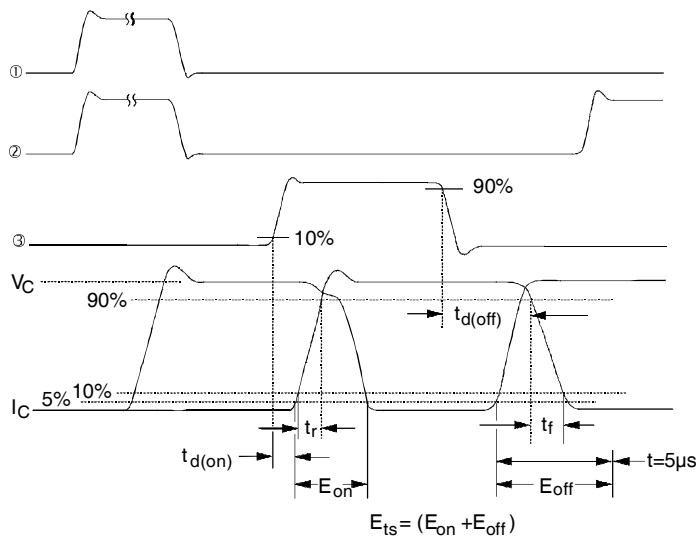


**Fig. 13b** - Pulsed Collector Current Test Circuit



**Fig. 14a** - Switching Loss Test Circuit

\* Driver same type as D.U.T.,  $V_C = 720V$

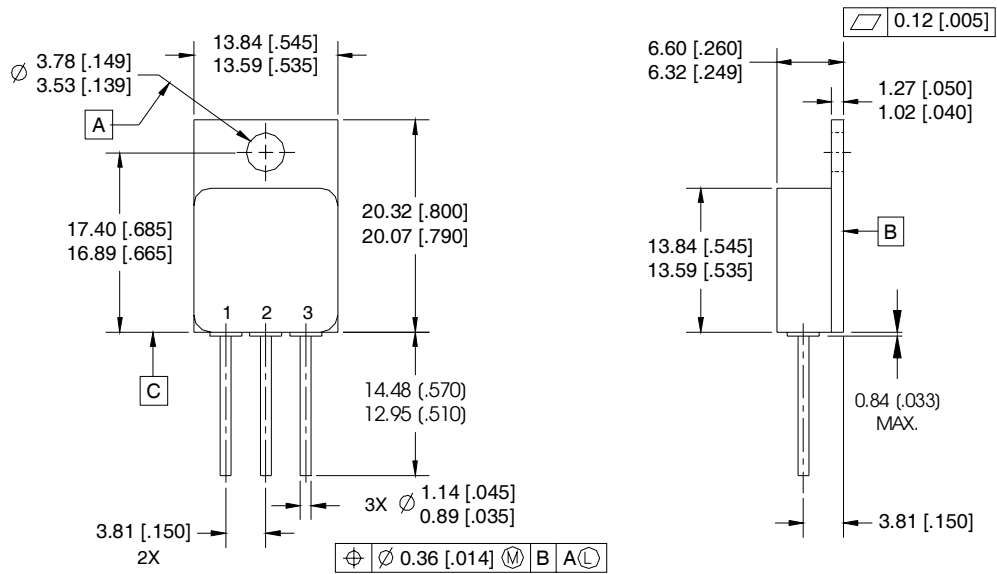


**Fig. 14b** - Switching Loss Waveforms

# IRG4MC40U

International  
**IR** Rectifier

## Case Outline and Dimensions — TO-254AA



### NOTES:

1. DIMENSIONING & TOLERANCING PER ASME Y14.5M-1994.
2. ALL DIMENSIONS ARE SHOWN IN MILLIMETERS [INCHES].
3. CONTROLLING DIMENSION: INCH.
4. CONFORMS TO JEDEC OUTLINE TO-254AA.

### PIN ASSIGNMENTS

- 1 = COLLECTOR
- 2 = EMITTER
- 3 = GATE

### CAUTION

#### BERYLLIA WARNING PER MIL-PRF-19500

Package containing beryllia shall not be ground, sandblasted, machined, or have other operations performed on them which will produce beryllia or beryllium dust. Furthermore, beryllium oxide packages shall not be placed in acids that will produce fumes containing beryllium.

International  
**IR** Rectifier

IR WORLD HEADQUARTERS: 233 Kansas St., El Segundo, California 90245, USA Tel: (310) 252-7105

IR LEOMINSTER : 205 Crawford St., Leominster, Massachusetts 01453, USA Tel: (978) 534-5776

TAC Fax: (310) 252-7903

Visit us at [www.irf.com](http://www.irf.com) for sales contact information.

Data and specifications subject to change without notice. 06/2008