

MSF2N40

400V N-Channel MOSFET

Description

The MSF2N40 is a N-channel enhancement-mode MOSFET , providing the designer with the best combination of fast switching, ruggedized device design, low on-resistance and cost effectiveness. The TO-220F package is universally preferred for all commercial-industrial applications

Features

- BVDSS=400V typically @ Tj=150°C
- Low On Resistance
- Simple Drive Requirement
- Low Gate Charge
- Fast Switching Characteristic
- RoHS compliant package

Application

- Adapter
- Switching Mode Power Supply

Packing & Order Information

50/Tube ; 1,000/Box



**RoHS
COMPLIANT**

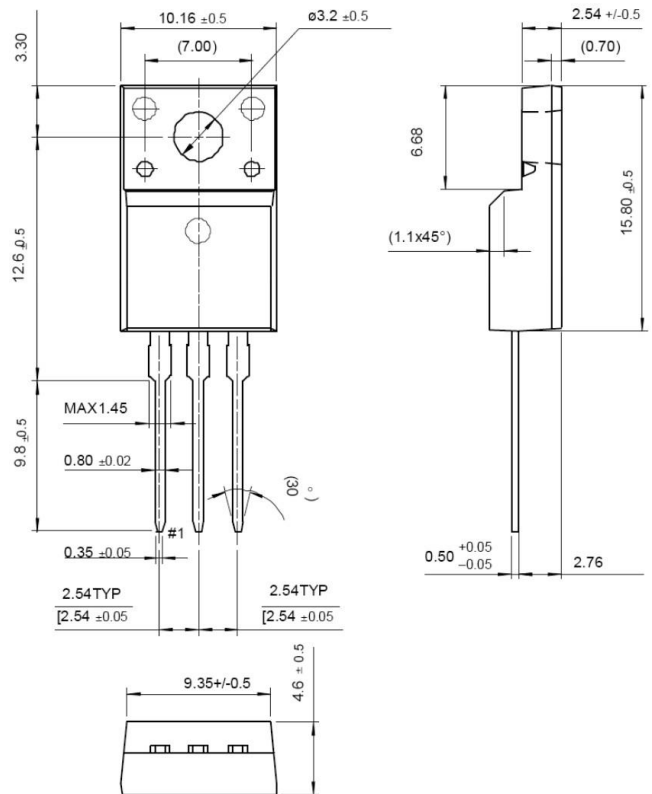

Graphic symbol

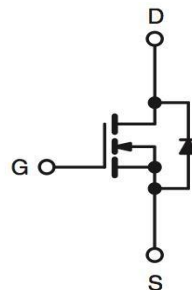

MAXIMUM RATINGS AND ELECTRICAL CHARACTERISTICS

Absolute Maximum Ratings

Symbol	Parameter	Value	Unit
V _{DSS}	Drain-Source Voltage	400	V
V _{GS}	Gate-Source Voltage	±30	V
I _D	Drain Current -Continuous (TC=25°C)	2.0	A
	Drain Current -Continuous (TC=100°C)	1.8	A
I _{DM}	Drain Current Pulsed	5.4	A
E _{AS}	Single Pulsed Avalanche Energy	100	mJ
E _{AR}	Repetitive Avalanche Energy	10	mJ
dv/dt	Peak Diode Recovery dv/dt	5.5	V/ns

MSF2N40

400V N-Channel MOSFET

Absolute Maximum Ratings			
Symbol	Parameter	Value	Unit
T_L	Maximum lead temperature for soldering purposes, 1/8" from case for 5 seconds	300	°C
TPKG	Maximum Temperature for Soldering @ Package Body for 10 seconds	260	°C
P_D	Total Power Dissipation (@TC = 25 °C) 44 W	24	W
	Derating Factor above 25 °C	0.3	W/°C
T_{STG}	Operating and Storage Temperature Range	-55 to +150	°C
T_J	Storage Temperature	150	°C

Note:

1. Repetitive rating; pulse width limited by maximum junction temperature.
2. $I_{AS}=5.5A$, $V_{DD}=50V$, $L=8mH$, $V_G=10V$, starting $T_J=+25°C$.
3. $I_{SD} \leq 5.5A$, $dI/dt \leq 100A/\mu s$, $V_{DD} \leq BVDSS$, starting $T_J=+25°C$.

Thermal characteristics (Tc=25°C unless otherwise noted)			
Symbol	Parameter	Max.	Units
Rthjc	Typical thermal resistance	2.87	°C/W
$R_{\theta JA}$	Typical thermal resistance	62.5	

* When mounted on the minimum pad size recommended (PCB Mount)

Static Characteristics					
Symbol	Test Conditions	Min	Typ.	Max.	Units
V_{GS}	$V_{DS} = V_{GS}, I_D = 250\mu A$	2.0	--	4.0	V
* $R_{DS(ON)}$	$V_{GS} = 10 V, I_D = 1.0 A$	--	1.0	1.5	Ω
BV_{DSS}	$V_{GS} = 0 V, I_D = 250\mu A$	400	--	--	V
$\Delta BV_{DSS}/\Delta T_J$	$I_D = 250\mu A$, Referenced to 25°C	--	0.4	--	
I_{DSS}	$V_{DS} = 400 V, V_{GS} = 0 V$	--	--	1	μA
	$V_{DS} = 320 V, V_{GS} = 0 V, T_C = 125°C$			10	
I_{GSSF}	$V_{GS} = 30 V, V_{DS} = 0 V$	--	--	100	nA
I_{GSSR}	$V_{GS} = -30 V, V_{DS} = 0 V$	--	--	-100	nA

Dynamic Characteristics					
Symbol	Test Conditions	Min	Typ.	Max.	Units
C_{ISS}	$V_{DS} = 25 V, V_{GS} = 0 V,$ $f = 1.0MHz$	--	670	870	pF
C_{OSS}		--	95	125	pF
C_{RSS}		--	16	21	pF

MSF2N40

400V N-Channel MOSFET

Dynamic Characteristics					
Symbol	Test Conditions	Min	Typ.	Max.	Units
$t_{d(on)}$	$V_{DS} = 200\text{ V}, I_D = 5.5\text{ A},$ $R_G = 25\ \Omega$	--	20	50	ns
t_r		--	50	110	ns
$t_{d(off)}$		--	90	190	ns
t_f		--	55	120	ns
Q_g	$V_{DS} = 320\text{ V}, I_D = 5.5\text{ A},$ $V_{GS} = 10\text{ V}$	--	25	33	nC
Q_{gs}		--	5.0	--	
Q_{gd}		--	10.0	--	

Source-Drain Diode Characteristics					
Symbol	Test Conditions	Min	Typ.	Max.	Units
I_S		--	--	2	A
I_{SM}		--	--	2.5	
V_{SD}	$I_S = 2\text{ A}, V_{GS} = 0\text{ V}$	--	--	1.5	V
t_{rr}	$I_S = 2\text{ A}, V_{GS} = 0\text{ V}$ $diF/dt = 100\text{ A}/\mu\text{s}$	--	220	--	ns
Q_{rr}		--	2	--	μC

Notes;

1. Repetitive Rating: Pulse width limited by maximum junction temperature
2. $I_{AS}=2\text{A}, V_{DD}=50\text{V}, R_G=25\text{W},$ Starting $T_J=25^\circ\text{C}$
3. $I_{SD}\leq 2\text{A}, di/dt\leq 300\text{A}/\mu\text{s}, V_{DD}\leq BV_{DSS},$ Starting $T_J=25^\circ\text{C}$
4. Pulse Test: Pulse Width $\leq 300\mu\text{s},$ Duty Cycle $\leq 2\%$
5. Essentially Independent of Operating Temperature

MSF2N40

400V N-Channel MOSFET

■ Characteristics Curve

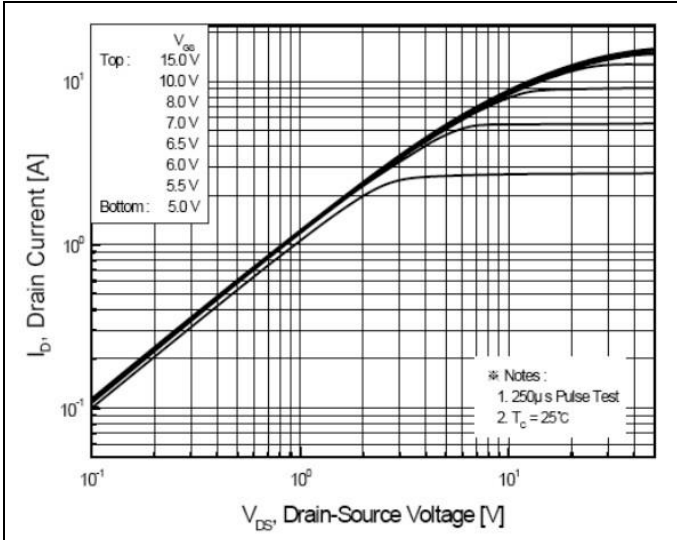

FIG.1-ON REGION CHARACTERISTICS

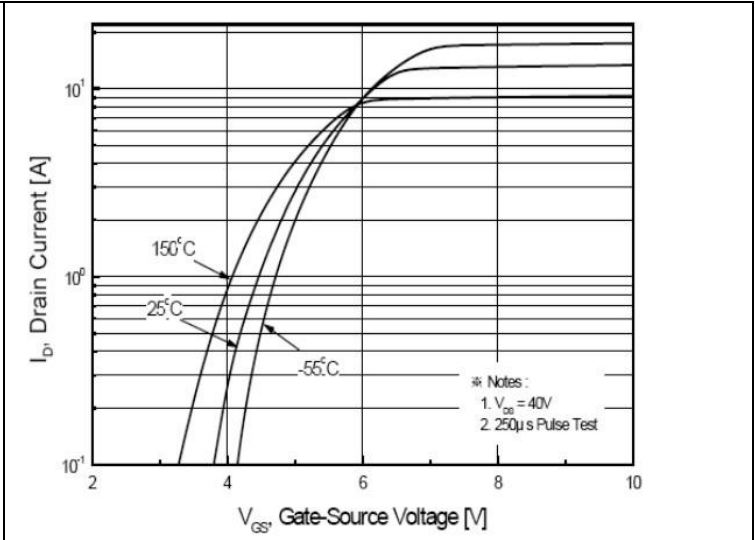

FIG.2-TRANSFER CHARACTERISTICS

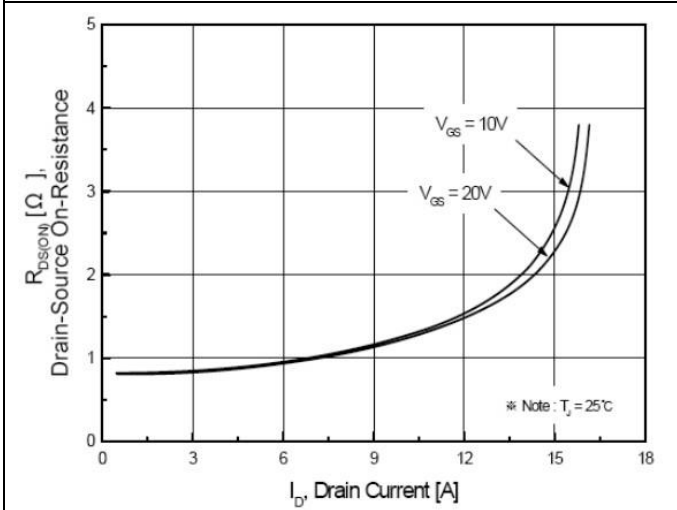

FIG.3-ON RESISTANCE VARIATION VS DRAIN CURRENT AND GATE VOLTAGE

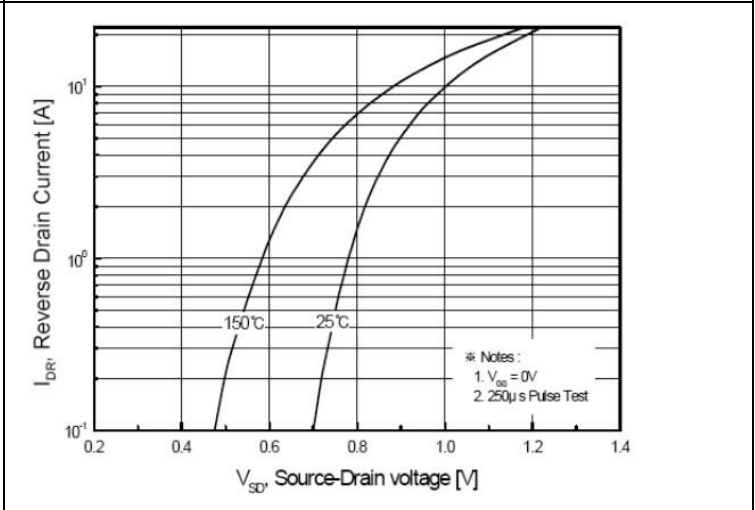

FIG.4-BODY DIODE FORWARD VOLTAGE VARIATION WITH SOURCE CURRENT AND TEMPERATURE

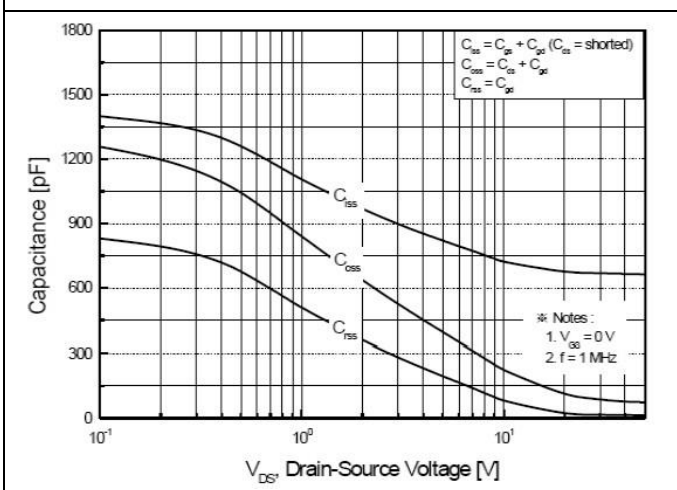

FIG.5-CAPACITANCE CHARACTERISTICS

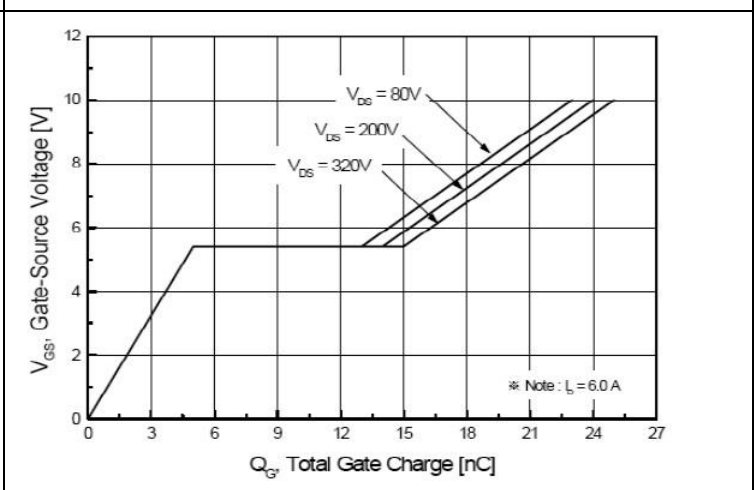

FIG.6-GATE CHARGE CHARACTERISTICS

MSF2N40

400V N-Channel MOSFET

■ Characteristics Curve

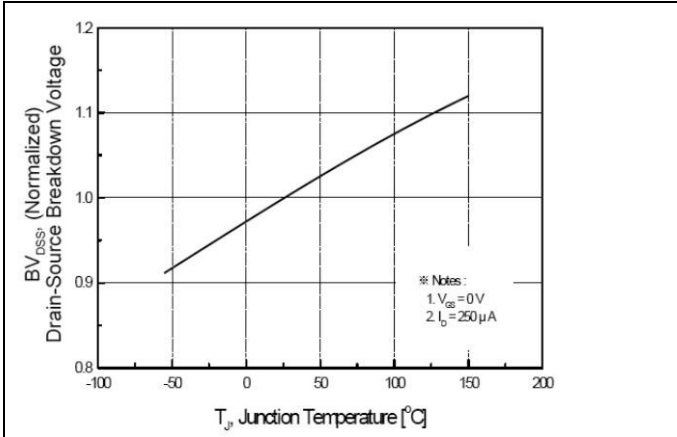

FIG.7-BREAKDOWN VOLTAGE VARIATION VS TEMPERATURE

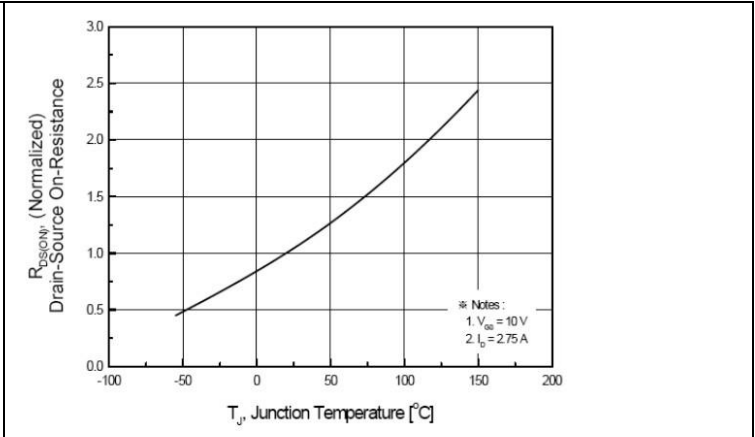

FIG.8-ON-RESISTANCE VARIATION VS TEMPERATURE

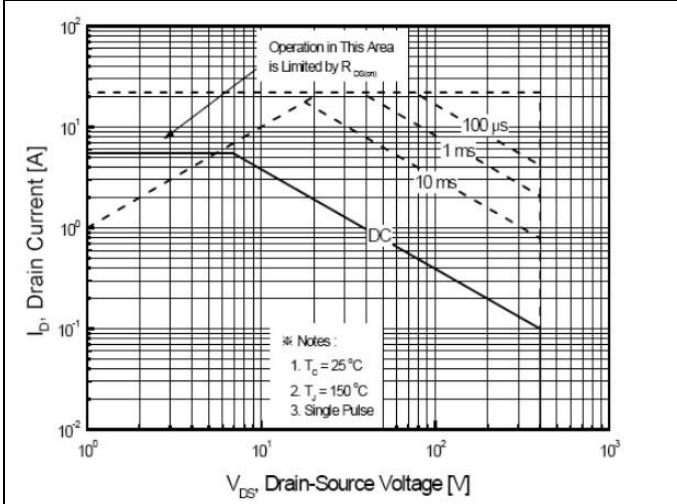

FIG.9-MAXIMUM SAFE OPERATING AREA

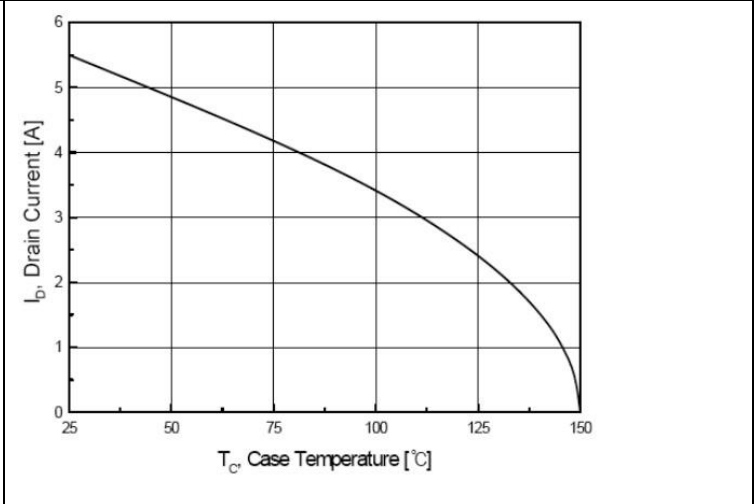

FIG.10-MAXIMUM DRAIN CURRENT VS CASE TEMPERATURE

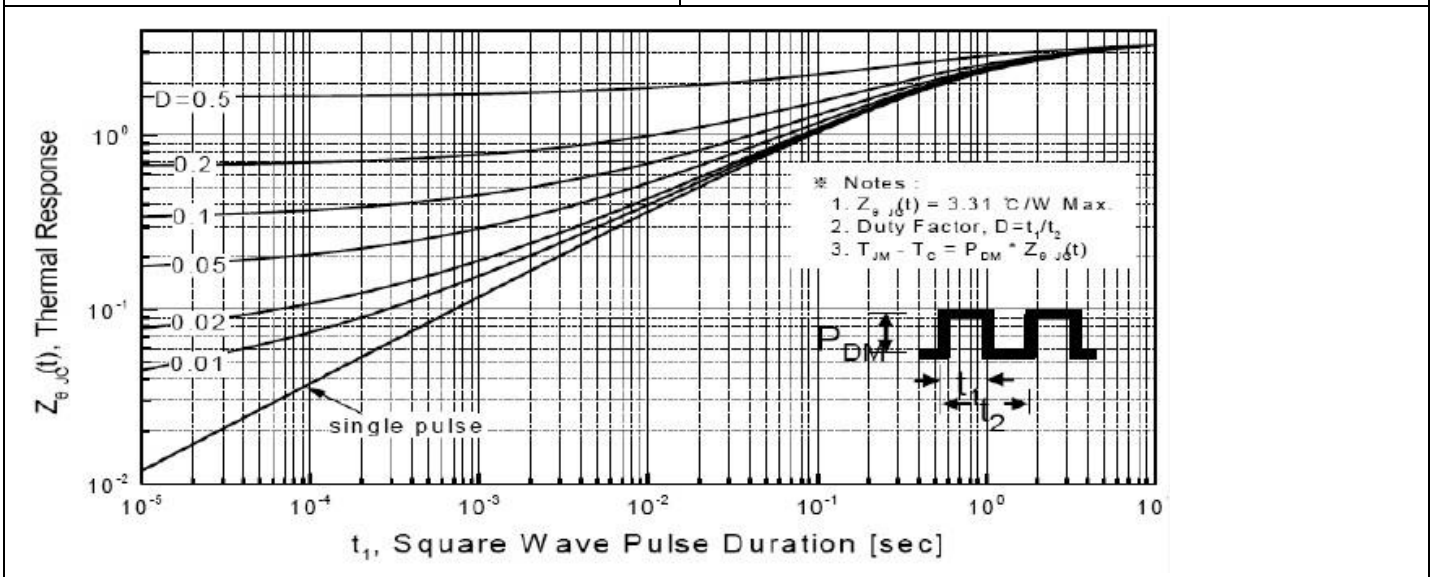

FIG.11-TRANSIENT THERMAL RESPONSE CURVE

MSF2N40

400V N-Channel MOSFET

Disclaimer

ALL PRODUCT, PRODUCT SPECIFICATIONS AND DATA ARE SUBJECT TO CHANGE WITHOUT NOTICE TO IMPROVE RELIABILITY, FUNCTION OR DESIGN OR OTHERWISE.

Bruckewell Technology Inc., its affiliates, agents, and employees, and all persons acting on its or their behalf (collectively, "Bruckewell"), disclaim any and all liability for any errors, inaccuracies or incompleteness contained in any datasheet or in any other disclosure relating to any product.

Bruckewell makes no warranty, representation or guarantee regarding the suitability of the products for any particular purpose or the continuing production of any product. To the maximum extent permitted by applicable law, Bruckewell disclaims

- (i) Any and all liability arising out of the application or use of any product.
- (ii) Any and all liability, including without limitation special, consequential or incidental damages.
- (iii) Any and all implied warranties, including warranties of fitness for particular purpose, non-infringement and merchantability.

Statements regarding the suitability of products for certain types of applications are based on Bruckewell's knowledge of typical requirements that are often placed on Bruckewell products in generic applications.

Such statements are not binding statements about the suitability of products for a particular application. It is the customer's responsibility to validate that a particular product with the properties described in the product specification is suitable for use in a particular application. Parameters provided in datasheets and/or specifications may vary in different applications and performance may vary over time.

Product specifications do not expand or otherwise modify Bruckewell's terms and conditions of purchase, including but not limited to the warranty expressed therein.