

# SDP8406

## Silicon Phototransistor

### FEATURES

- Side-looking plastic package
- 50° (nominal) acceptance angle
- Wide sensitivity ranges
- Mechanically and spectrally matched to SEP8506 and SEP8706 infrared emitting diodes

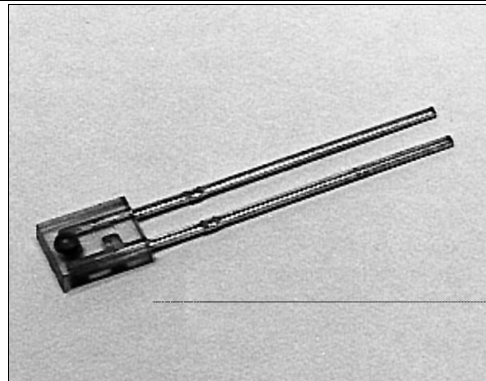

INFRA-21.TIF

### DESCRIPTION

The SDP8406 is an NPN silicon phototransistor molded in a side-looking clear plastic package. The chip is positioned to accept radiation through a plastic lens from the side of the package.

### OUTLINE DIMENSIONS in inches (mm)

Tolerance 3 plc decimals ±0.005(0.12)  
2 plc decimals ±0.020(0.51)

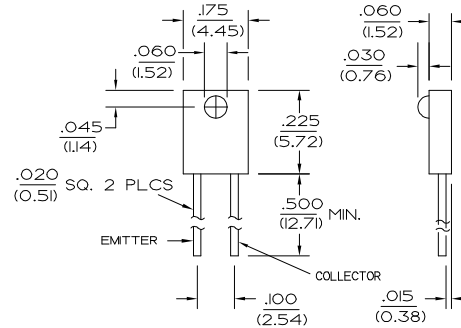

DIM\_017.d54

# SDP8406

## Silicon Phototransistor

### ELECTRICAL CHARACTERISTICS (25°C unless otherwise noted)

PARAMETER	SYMBOL	MIN	TYP	MAX	UNITS	TEST CONDITIONS
Light Current	$I_L$				mA	$V_{CE}=5\text{ V}$ $H=1\text{ mW/cm}^2$ (1)
SDP8406-001		0.15	1.90			
SDP8406-002		1.80	3.60			
SDP8406-003		3.40	6.50			
SDP8406-004		6.40	12.0			
Collector Dark Current	$I_{CEO}$			100	nA	$V_{CE}=15\text{ V}$ , $H=0$
Collector-Emitter Breakdown Voltage	$V_{(BR)CEO}$	30			V	$I_C=100\text{ }\mu\text{A}$
Emitter-Collector Breakdown Voltage	$V_{(BR)ECO}$	5.0			V	$I_E=100\text{ }\mu\text{A}$
Collector-Emitter Saturation Voltage	$V_{CE(SAT)}$			0.4	V	$I_C=I_L/8$ $H=1\text{ mW/cm}^2$
Angular Response (2)	$\varnothing$		50		degr.	$I_F=\text{Constant}$
Rise And Fall Time	$t_r, t_f$		15		$\mu\text{s}$	$V_{CC}=5\text{ V}$ , $I_L=1\text{ mA}$ $R_L=1000\text{ }\Omega$

#### Notes

- The radiation source is an IRED with a peak wavelength of 935 nm.
- Angular response is defined as the total included angle between the half sensitivity points.

### ABSOLUTE MAXIMUM RATINGS

(25°C Free-Air Temperature unless otherwise noted)

Collector-Emitter Voltage	30 V
Emitter-Collector Voltage	5 V
Power Dissipation	100 mW (1)
Operating Temperature Range	-40°C to 85°C
Storage Temperature Range	-40°C to 85°C
Soldering Temperature (5 sec)	240°C

#### Notes

- Derate linearly from 25°C free-air temperature at the rate of 0.78 mW/°C.

### SCHEMATIC

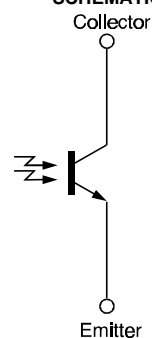

Honeywell reserves the right to make changes in order to improve design and supply the best products possible.

# Honeywell

# SDP8406

## Silicon Phototransistor

### SWITCHING TIME TEST CIRCUIT

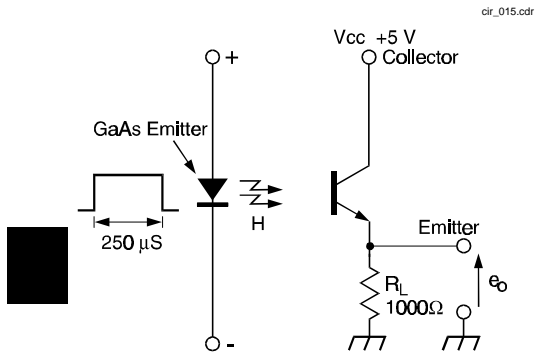

Fig. 1 Responsivity vs Angular Displacement

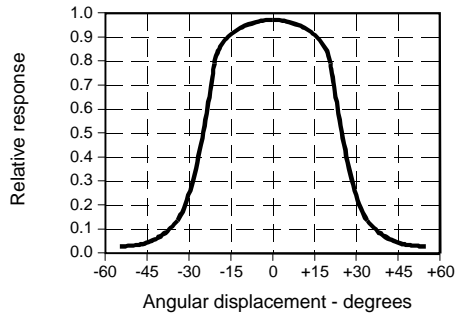
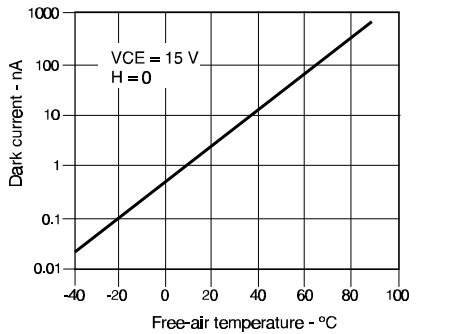

Fig. 3 Dark Current vs Temperature



### SWITCHING WAVEFORM

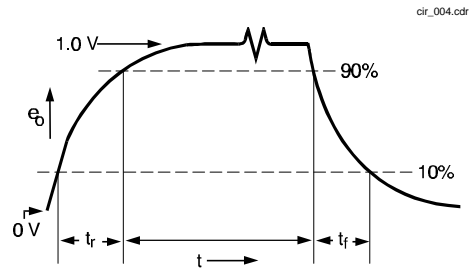

Fig. 2 Collector Current vs Ambient Temperature

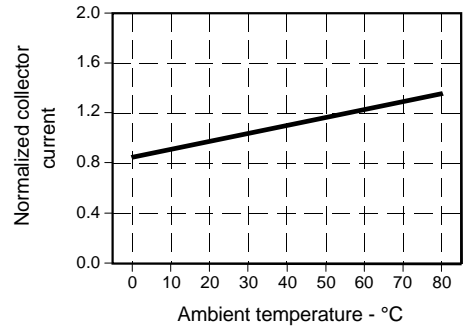
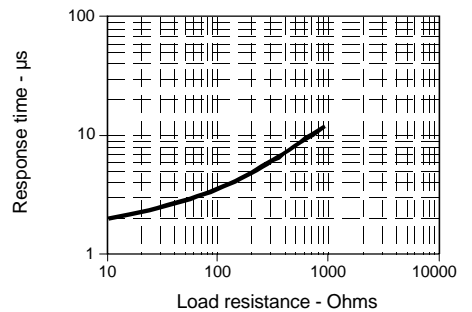

Fig. 4 Non-Saturated Switching Time vs Load Resistance



# SDP8406

## Silicon Phototransistor

Fig. 5 Spectral Responsivity

gra\_036.ds4

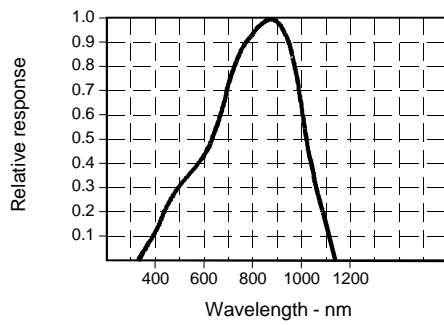

All Performance Curves Show Typical Values

Fig. 6 Coupling Characteristics with SEP8506

gra\_031.ds4

