

### Applications

- Small-Cell Basestations
- Enterprise Femtocell
- Bands 5, 6, 8, 12, 13, 14, 17, 20, 26, 27, 28, 29

### Product Features

- Frequency Range : 0.7-1.0 GHz
- Covers multiple bands with one component
- Fully integrated, 2-stage Power Amplifier
- Internally matched 50  $\Omega$  input/output
- -50dBc ACLR (corrected) @ +28 dBm Pavg
- 32 dB Gain
- 27% PAE @ +28 dBm Pavg
- In-built Control Bias and Temp. Comp Circuit
- Single Supply Voltage : 5V
- Lead-free / RoHS compliant
- POE Capable

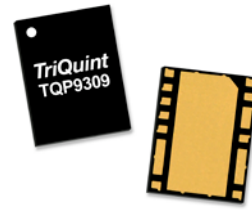

3.5x4.5 mm Leadless SMT Package

### Functional Block Diagram

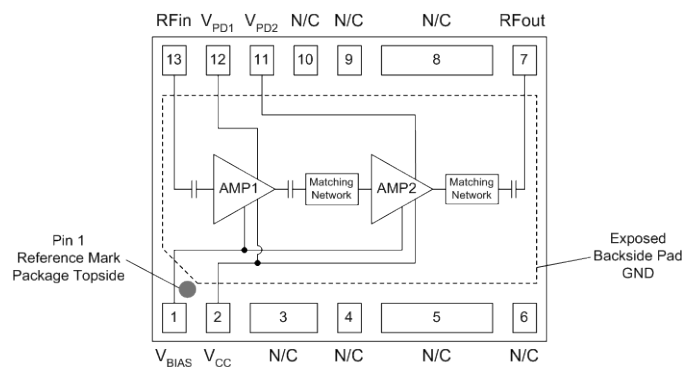

### General Description

The TQP9309 is a high-efficiency two-stage power amplifier in a low-cost surface-mount package with on-chip bias control and temperature compensation circuitry, suitable for small cell base station applications.

TQP9309 provides 32 dB gain and >+28 dBm linear power with pre-distortion correction over the 0.7-1.0 GHz frequency range for Bands 5, 6, 8, 12, 13, 14, 17, 20, 26, 27, 28, and 29. With pre-distortion, the amplifier is able to achieve -50dBc ACLR at 28 dBm output power using a 20 MHz LTE signal.

The TQP9309 integrates two high performance amplifier stages onto a module to allow for a compact system design and requires very few external components for operation. The amplifier is bias adjustable allowing the amplifier's power consumption to be optimized. The TQP9309 is available in a lead-free/RoHS-compliant 3.5x4.5mm surface mount package and is pin-compatible to the 1.8-2.2 GHz TQP9321 and 2.5-2.7 GHz TQP9326.

### Pin Configuration

Pin No.	Label
1	Vbias
2	Vcc
3, 4, 5, 6, 8, 9, 10	GND or NC
7	RFout
11	Vpd2
12	Vpd1
13	RFin
Backside Paddle	RF/DC Ground

### Ordering Information

Part No.	Description
TQP9309	0.7-1.0 GHz Power Amplifier
TQP9309-PCB	Evaluation board

Standard T/R size: 2500 pcs. on a 13" reel

### Absolute Maximum Ratings

Parameter	Rating
Storage Temperature	-40 to 150°C
Supply Voltage (V <sub>CC</sub> )	6V
RF Input Power, CW, 50Ω, T=25°C	10dBm

Operation of this device outside the parameter ranges given above may cause permanent damage.

### Recommended Operating Conditions

Parameter	Min	Typ	Max	Units
V <sub>DD</sub>		5		V
T <sub>AMB</sub>	-40	25	+85	°C
T <sub>j</sub> for >10 <sup>6</sup> hours MTTF			+190	°C

Notes:

- Electrical specifications are measured at specified test conditions. Specifications are not guaranteed over all recommended operating conditions.

### Electrical Specifications

Test conditions unless otherwise noted: V<sub>CC</sub> = +5V, V<sub>pd</sub> = +5V, Temp = +25°C, Test Frequency : 900MHz

Parameter	Conditions	Min	Typ	Max	Units
Operational Frequency Range		700		960	MHz
Output Channel Power			+28		dBm
Gain	700 - 800MHz	28.6	31		dB
	800 - 960MHz	<b>29.6</b>	<b>32</b>	<b>33.3</b>	dB
Gain Temperature Coefficient			-0.026		dB/°C
ACLR Uncorrected	See note 1		-37		dBc
ACLR Corrected	See note 1		-50		dBc
Power Added Efficiency	See note 1		27		%
Noise Figure			4		dB
Output P3dB		<b>+33.9</b>	<b>+35</b>		dBm
P3dB Temperature Coefficient			-0.005		dBm/°C
Supply Voltage			5		V
Quiescent Current, I <sub>CO</sub>		<b>85</b>	<b>100</b>	<b>127</b>	mA
Operational Current, I <sub>CC</sub>			380		mA
VSWR Survivability	P <sub>out</sub> = +26 dBm Signal : WCDMA 1C, PAR = 8 dB	7:1			-
Thermal Resistance, θ <sub>jc</sub>	Module (junction to case)		28.3		°C/W

Notes:

- Using LTE signal, 20MHz, IBW = 18.02 MHz, PAR 7.5dB, P<sub>out</sub> = +28 dBm
- Items in min/max columns in **bold** at guaranteed by production test at 900 MHz
- Items in min/max columns that are not a bold font are guaranteed by design characterization.

**Performance Plots**

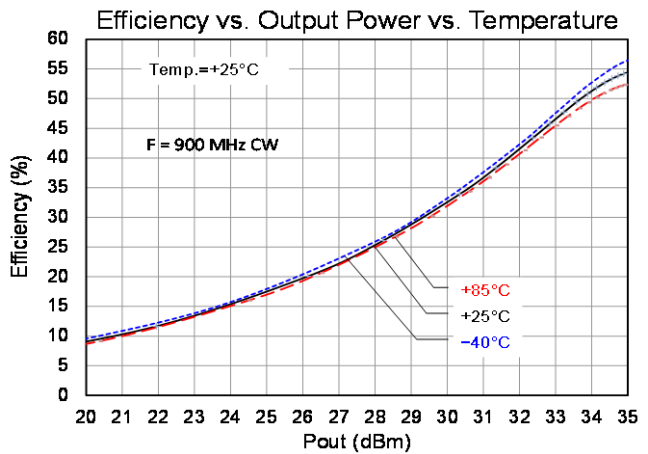
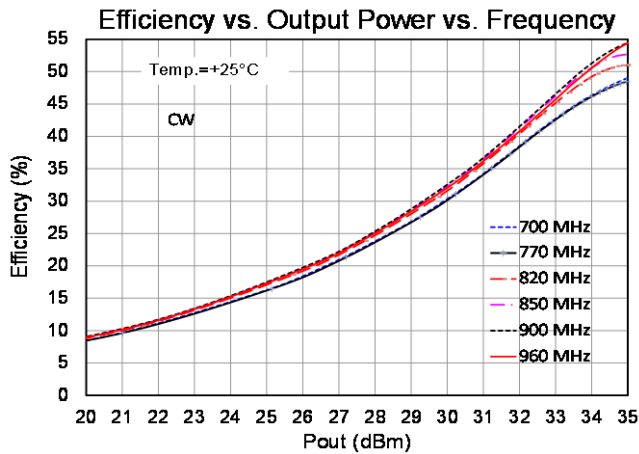
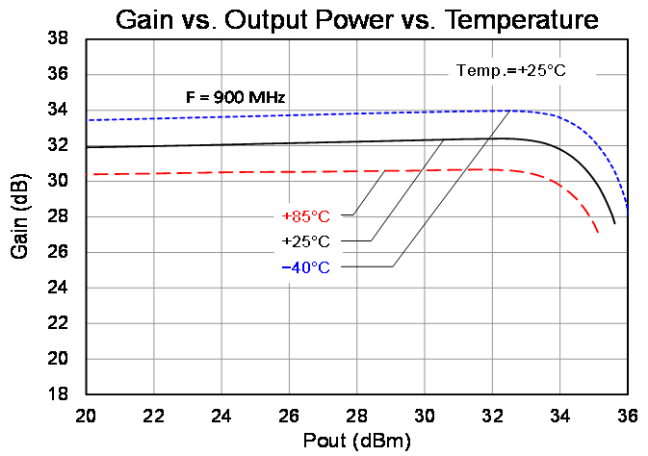
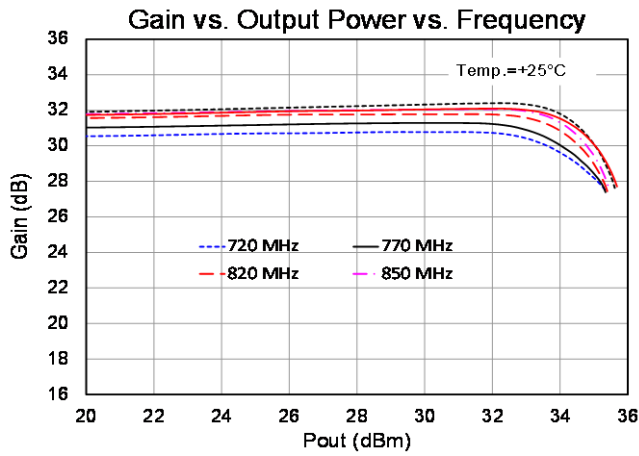

## Performance Plots (continued)

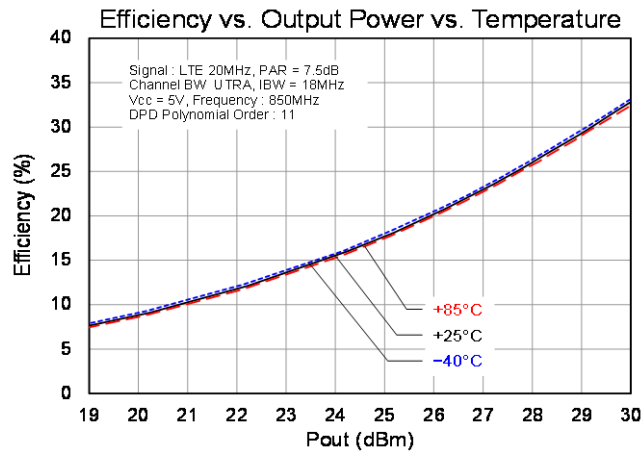
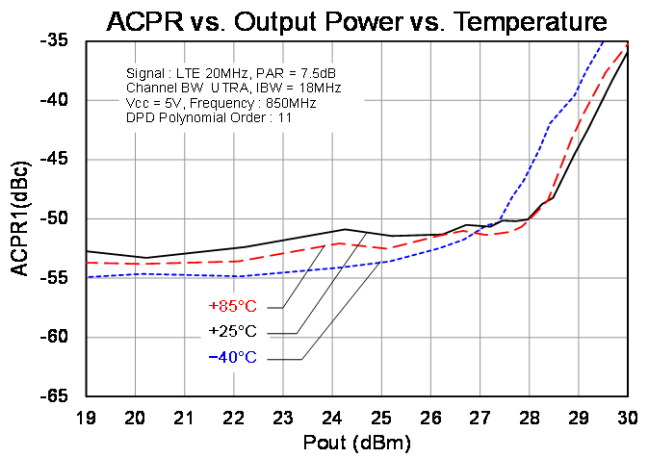
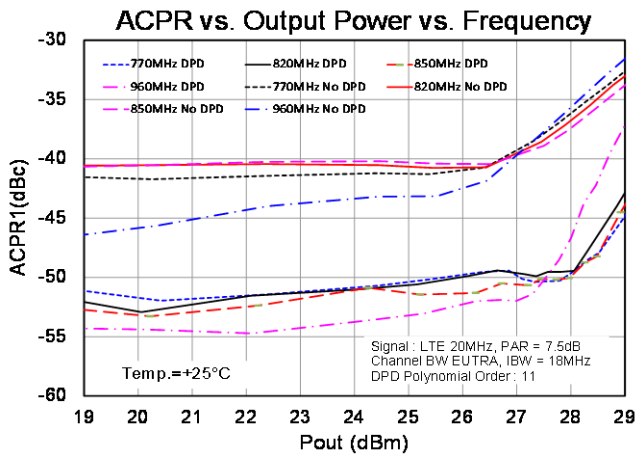
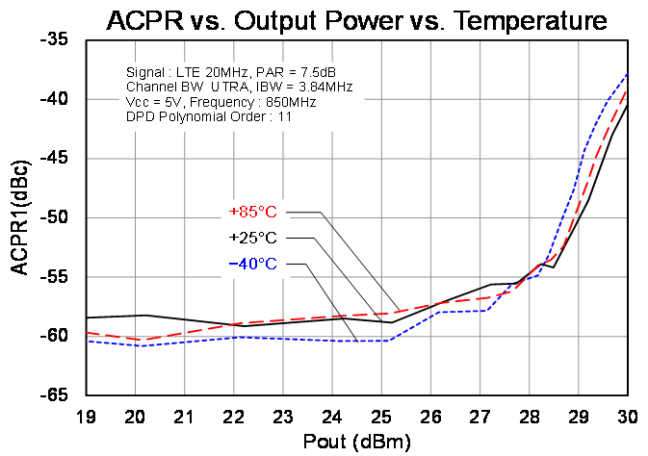
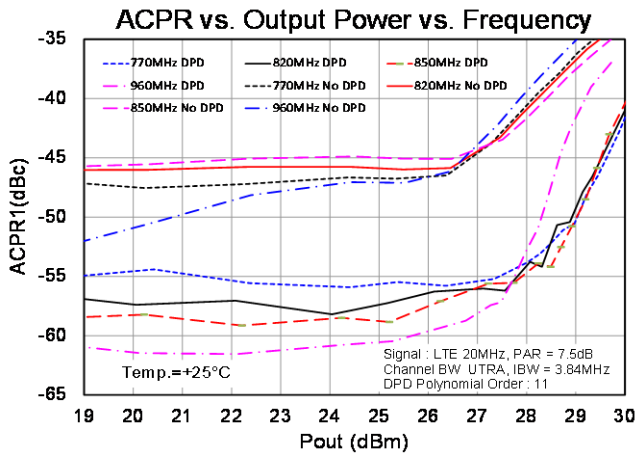

## Application Circuit

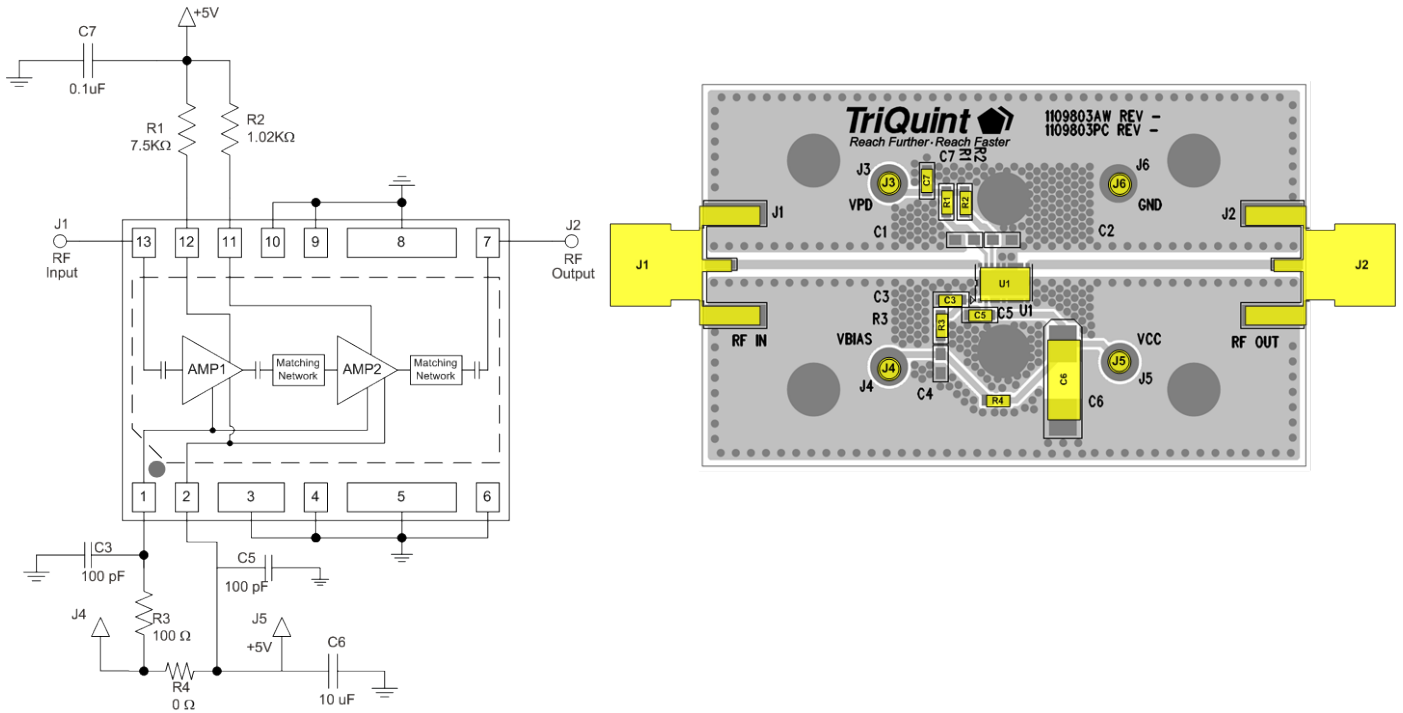

## Bill of Material

Ref Des	Value	Description	Manuf.	Part Number
n/a	n/a	Printed Circuit Board		1109803
U1	n/a	High Efficiency 2-stage PA	TriQuint	TQP9309
R3, R4	0 Ω	Resistor, Chip, 0603, 5%	various	
C7	0.1 uF	Capacitor, Chip, 0603, 5%	various	
C6	10 uF	Capacitor, Chip, 6032, 10%, Tantalum	various	
C3, C5	100 pF	Capacitor, Chip, 0603, NPO/COG, 5%	various	
R2	1.0 KΩ	Resistor, Chip, 0603, 5%, 1/16W	various	
R1	7.5 KΩ	Resistor, Chip, 0603, 5%, 1/16W	various	
C1, C2, C4		Do Not Place		

### Pin Configuration and Description

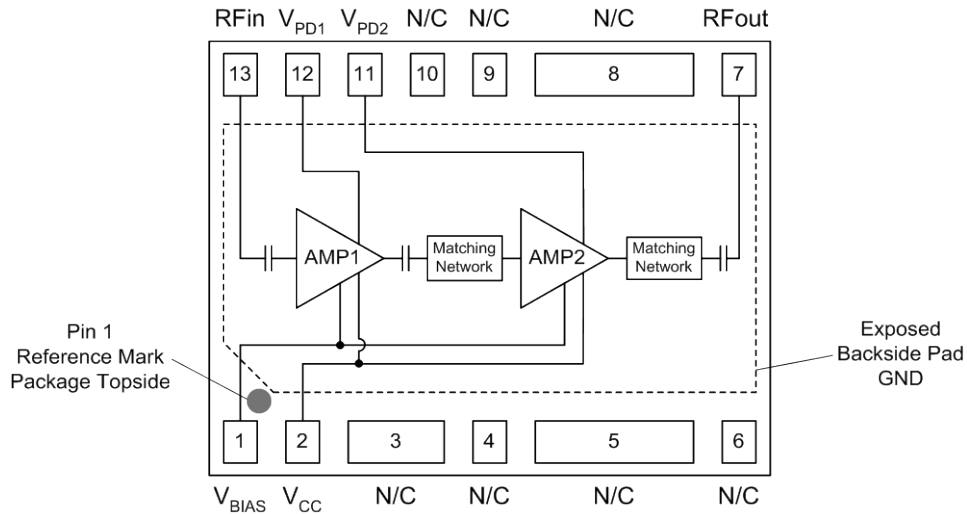

Pin No.	Label	Description
1	Vbias	Provides reference voltage for internal active biasing circuit
2	Vcc	DC voltage supply connection
3, 4, 5, 6, 8, 9, 10	GND/NC	No internal connection. Provide grounded land pads for PCB mounting integrity.
7	RFout	RF output pin. The DC is internally blocked at this pin.
11	Vpd2	Power down for Amp 1. This voltage adjusts for the current draw in Amp 1.
12	Vpd1	Power down for Amp 2. This voltage adjusts for the current draw in Amp 2.
13	RFin	RF input pin. The DC is internally blocked at this pin.
Backside Paddle	RF/DC GND	RF/DC ground. Use recommended via pattern to minimize inductance and thermal resistance; see PCB Mounting Pattern for suggested footprint.

**Mechanical Information**

**Package Marking and Dimensions**

Marking: Part number – 9309  
Assembly Code - YYWW  
Lot code –aaXXXX

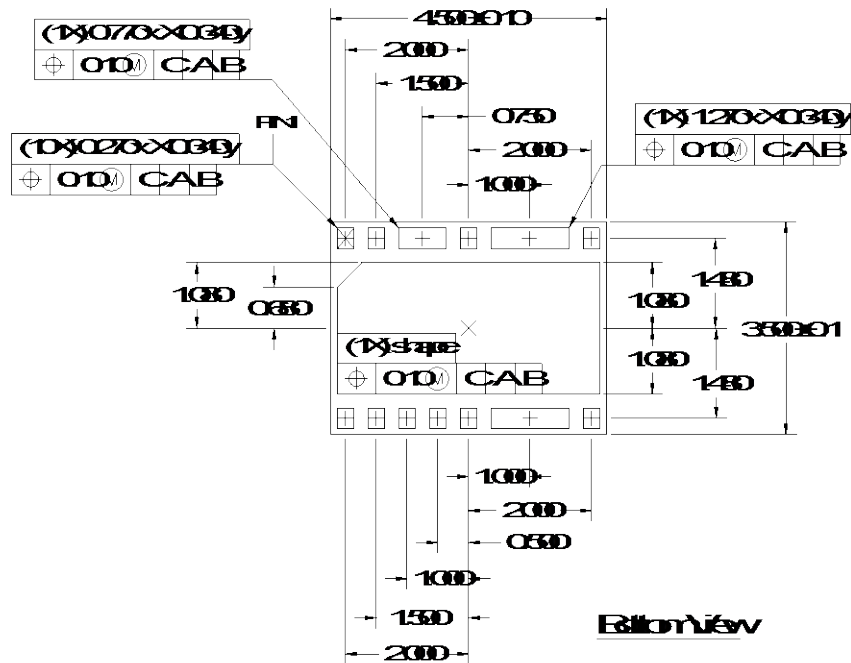
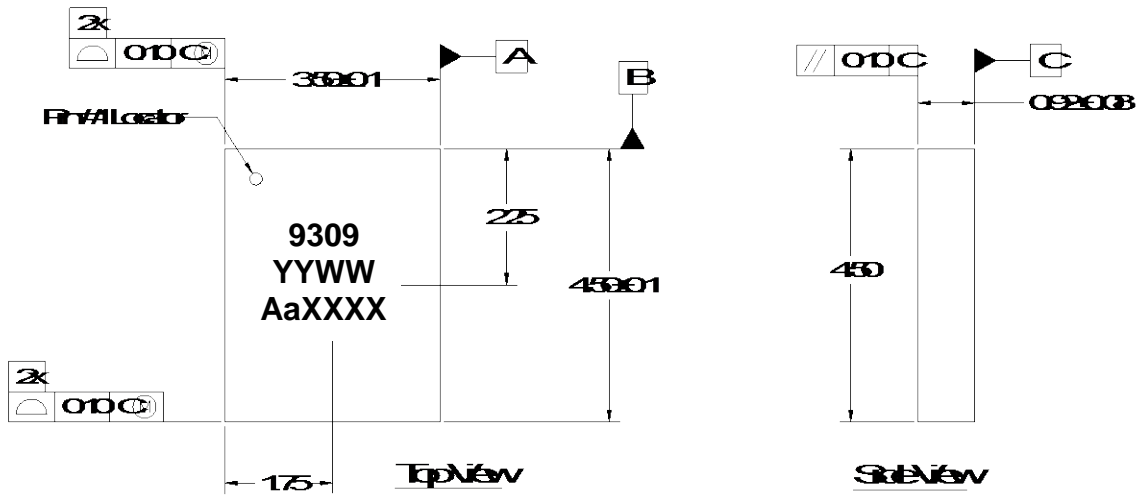

Notes:

1. All dimensions are in millimeters. Angles are in degrees.
2. Dimension and tolerance formats conform to ASME Y14.4M-1994.
3. The terminal #1 identifier and terminal numbering conform to JESD 95-1 SPP-012.

## Product Compliance Information

### ESD Sensitivity Ratings



Caution! ESD-Sensitive Device

ESD Rating: Class 2  
Value: Passes  $\geq 2000V$  and  $< 4000V$   
Test: Human Body Model (HBM)  
Standard: JEDEC Standard JESD22-A114

ESD Rating: Class C3  
Value: Passes  $\geq 1000V$   
Test: Charged Device Model (CDM)  
Standard: JEDEC Standard JESD22-C101

### MSL Rating

MSL Rating: MSL3  
Test:  $260^{\circ}C$  convection reflow  
Standard: JEDEC Standard IPC/JEDEC J-STD-020

### Solderability

Compatible with both lead-free ( $260^{\circ}C$  maximum reflow temperature) and tin/lead ( $245^{\circ}C$  maximum reflow temperature) soldering processes.

Contact plating: Electrolytic plated Au over Ni

### RoHS Compliance

This part is compliant with EU 2002/95/EC RoHS directive (Restrictions on the Use of Certain Hazardous Substances in Electrical and Electronic Equipment).

This product also has the following attributes:

- Lead Free
- Halogen Free (Chlorine, Bromine)
- Antimony Free
- TBBP-A ( $C_{15}H_{12}Br_4O_2$ ) Free
- PFOS Free
- SVHC Free

## Important Notice

The information contained herein is believed to be reliable. TriQuint makes no warranties regarding the information contained herein. TriQuint assumes no responsibility or liability whatsoever for any of the information contained herein. TriQuint assumes no responsibility or liability whatsoever for the use of the information contained herein. The information contained herein is provided "AS IS, WHERE IS" and with all faults, and the entire risk associated with such information is entirely with the user. All information contained herein is subject to change without notice. Customers should obtain and verify the latest relevant information before placing orders for TriQuint products. The information contained herein or any use of such information does not grant, explicitly or implicitly, to any party any patent rights, licenses, or any other intellectual property rights, whether with regard to such information itself or anything described by such information.

TriQuint products are not warranted or authorized for use as critical components in medical, life-saving, or life-sustaining applications, or other applications where a failure would reasonably be expected to cause severe personal injury or death.

## Contact Information

For the latest specifications, additional product information, worldwide sales and distribution locations, and information about TriQuint:

Web: [www.triquint.com](http://www.triquint.com)  
Email: [info-sales@triquint.com](mailto:info-sales@triquint.com)

Tel: +1.503.615.9000  
Fax: +1.503.615.8902

For technical questions and application information: Email: [sjcappliations.engineering@triquint.com](mailto:sjcappliations.engineering@triquint.com)