

# TS79M00A Series

## 3-Terminal 500mA Negative Voltage Regulator

TO-220



TO-252 (DPAK)

**Pin Definition:**

1. Input
2. Ground (tab)
3. Output

### General Description

The TS79M00A series of fixed output negative voltage regulators are intended as complements to the popular TS78M00A series device. These negative regulators are available in the same seven-voltage options as the TS7900A devices. In addition, one extra voltage option commonly employed in MECL systems is also available in the negative TS79M00A Series. Available in fixed output voltage options from -5.0 to -24 volts, these regulators employ current limiting, thermal shutdown, and safe-area compensation--making them remarkably rugged under most operating conditions. With adequate heat sinking they can deliver output currents in excess of 0.5 ampere. This series is offered in 3-pin TO-220 & TO-252 package.

### Features

- Output Voltage Range -5 to -24V
- Output current up to 0.5A
- No external components required
- Internal thermal overload protection
- Internal short-circuit current limiting
- Output transistor safe-area compensation
- Output voltage offered in 2% tolerance

### Ordering Information

Part No.	Package	Packing
TS79MxxACZ C0	TO-220	50pcs / Tube
TS79MxxACP RO	TO-252	2.5Kpcs / 13" Reel

Note: Where **xx** denote voltage option

### Standard Application Circuit

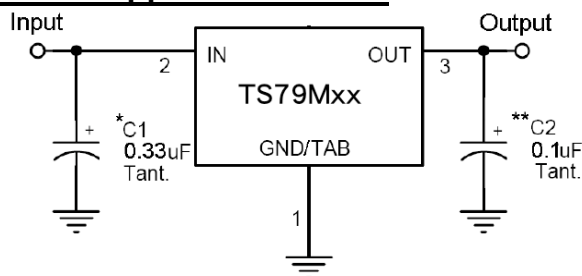

A common ground is required between the input and the output voltages. The input voltage must remain typically 2.0V above the output voltage even during the low point on the Input ripple voltage.

XX = these two digits of the type number indicate voltage.

\* = Cin is required if regulator is located an appreciable distance from power supply filter.

\*\* = Co is not needed for stability; however, it does improve transient response.

### Absolute Maximum Rating (Ta = 25°C unless otherwise noted)

Parameter	Symbol	Limit	Unit
Input Voltage	V <sub>IN</sub> *	-35	V
Input Voltage	V <sub>IN</sub> **	-40	V
Power Dissipation	P <sub>D</sub>	Internal Limited	W
Operating Junction Temperature	T <sub>J</sub>	0~+125	°C
Storage Temperature Range	T <sub>STG</sub>	-65~+150	°C

Note: \* TS79M05A to TS79M18A

\*\* TS79M24A

\*\*\* Follow the derating curve

# TS79M00A Series

## 3-Terminal 500mA Negative Voltage Regulator

### TS79M05A Electrical Characteristics

( $V_{in} = -10V$ ,  $I_{out} = 350mA$ ,  $0^{\circ}C \leq T_j \leq 125^{\circ}C$ ,  $C_{in} = 0.33\mu F$ ,  $C_{out} = 0.1\mu F$ ; unless otherwise specified.)

Parameter	Symbol	Test Condition	Min	Typ	Max	Unit	
Output voltage	Vout	$T_j = 25^{\circ}C$	-4.90	-5	-5.10	V	
		$-7.5V \leq V_{in} \leq -20V$ , $5mA \leq I_{out} \leq 500mA$ , $PD \leq 5W$	-4.85	-5	-5.15		
Line Regulation	REGline	$T_j = 25^{\circ}C$	$-7.5V \leq V_{in} \leq -25V$	--	7	50	mV
			$-8V \leq V_{in} \leq -18V$	--	2	30	
Load Regulation	REGload	$T_j = 25^{\circ}C$	$5mA \leq I_{out} \leq 500mA$	--	20	100	
			$250mA \leq I_{out} \leq 200mA$	--	10	50	
Quiescent Current	Iq	$I_{out} = 0$ , $T_j = 25^{\circ}C$	--	4	8	mA	
Quiescent Current Change	$\Delta Iq$	$-7.5V \leq V_{in} \leq -25V$	--	--	1		
		$5mA \leq I_{out} \leq 500mA$	--	--	0.5		
Output Noise Voltage	Vn	$10Hz \leq f \leq 100KHz$ , $T_j = 25^{\circ}C$	--	40	--	$\mu V$	
Ripple Rejection Ratio	RR	$f = 120Hz$ , $-8V \leq V_{in} \leq -18V$	54	66	--	dB	
Voltage Drop	Vdrop	$I_{out} = 500mA$ , $T_j = 25^{\circ}C$	--	2	--	V	
Peak Output Current	I <sub>o peak</sub>	$T_j = 25^{\circ}C$	--	0.7	--	A	
Temperature Coefficient of Output Voltage	$\Delta V_{out} / \Delta T_j$	$I_{out} = 5mA$ , $0^{\circ}C \leq T_j \leq 125^{\circ}C$	--	-0.1	--	$mV/^{\circ}C$	

### TS79M06A Electrical Characteristics

( $V_{in} = -11V$ ,  $I_{out} = 350mA$ ,  $0^{\circ}C \leq T_j \leq 125^{\circ}C$ ,  $C_{in} = 0.33\mu F$ ,  $C_{out} = 0.1\mu F$ ; unless otherwise specified.)

Parameter	Symbol	Test Condition	Min	Typ	Max	Unit	
Output Voltage	Vout	$T_j = 25^{\circ}C$	-5.88	-6	-6.12	V	
		$-8.5V \leq V_{in} \leq -21V$ , $5mA \leq I_{out} \leq 500mA$ , $PD \leq 5W$	-5.76	-6	-6.24		
Line Regulation	REGline	$T_j = 25^{\circ}C$	$-8.5V \leq V_{in} \leq -25V$	--	5	120	mV
			$-9V \leq V_{in} \leq -13V$	--	1.5	60	
Load Regulation	REGload	$T_j = 25^{\circ}C$	$5mA \leq I_{out} \leq 500mA$	--	14	120	
			$250mA \leq I_{out} \leq 200mA$	--	4	60	
Quiescent Current	Iq	$I_{out} = 0$ , $T_j = 25^{\circ}C$	--	4	8	mA	
Quiescent Current Change	$\Delta Iq$	$-8.5V \leq V_{in} \leq -25V$	--	--	1		
		$5mA \leq I_{out} \leq 500mA$	--	--	0.5		
Output Noise Voltage	Vn	$10Hz \leq f \leq 100KHz$ , $T_j = 25^{\circ}C$	--	44	--	$\mu V$	
Ripple Rejection Ratio	RR	$f = 120Hz$ , $-9V \leq V_{in} \leq -19V$	60	73	--	dB	
Voltage Drop	Vdrop	$I_{out} = 500mA$ , $T_j = 25^{\circ}C$	--	2	--	V	
Peak Output Current	I <sub>o peak</sub>	$T_j = 25^{\circ}C$	--	0.7	--	A	
Temperature Coefficient of Output Voltage	$\Delta V_{out} / \Delta T_j$	$I_{out} = 5mA$ , $0^{\circ}C \leq T_j \leq 125^{\circ}C$	--	-0.1	--	$mV/^{\circ}C$	

- Pulse testing techniques are used to maintain the junction temperature as close to the ambient temperature as possible, and thermal effects must be taken into account separately.
- This specification applies only for DC power dissipation permitted by absolute maximum ratings.

# TS79M00A Series

## 3-Terminal 500mA Negative Voltage Regulator

### TS79M08A Electrical Characteristics

$V_{in} = -14V$ ,  $I_{out} = 350mA$ ,  $0^{\circ}C \leq T_j \leq 125^{\circ}C$ ,  $C_{in} = 0.33\mu F$ ,  $C_{out} = 0.1\mu F$ ; unless otherwise specified.)

Parameter	Symbol	Test Condition	Min	Typ	Max	Unit	
Output voltage	Vout	$T_j = 25^{\circ}C$	-7.84	-8	-8.16	V	
		$-10.5V \leq V_{in} \leq -23V$ , $5mA \leq I_{out} \leq 500mA$ , $PD \leq 5W$	-7.68	-8	-8.32		
Line Regulation	REGline	$T_j = 25^{\circ}C$	$-10.5V \leq V_{in} \leq -25V$	--	6	160	mV
			$-11V \leq V_{in} \leq -17V$	--	2	80	
Load Regulation	REGload	$T_j = 25^{\circ}C$	$5mA \leq I_{out} \leq 500mA$	--	12	160	
			$250mA \leq I_{out} \leq 200mA$	--	4	80	
Quiescent Current	Iq	$I_{out} = 0$ , $T_j = 25^{\circ}C$	--	4.3	8	mA	
Quiescent Current Change	$\Delta Iq$	$10.5V \leq V_{in} \leq 25V$	--	--	1		
		$5mA \leq I_{out} \leq 500mA$	--	--	0.5		
Output Noise Voltage	Vn	$10Hz \leq f \leq 100KHz$ , $T_j = 25^{\circ}C$	--	52	--	$\mu V$	
Ripple Rejection Ratio	RR	$f = 120Hz$ , $11V \leq V_{in} \leq 21V$	56	72	--	dB	
Voltage Drop	Vdrop	$I_{out} = 500mA$ , $T_j = 25^{\circ}C$	--	2	--	V	
Peak Output Current	I <sub>o peak</sub>	$T_j = 25^{\circ}C$	--	0.7	--	A	
Temperature Coefficient of Output Voltage	$\Delta V_{out} / \Delta T_j$	$I_{out} = 5mA$ , $0^{\circ}C \leq T_j \leq 125^{\circ}C$	--	-1	--	$mV/^{\circ}C$	

### TS79M09A Electrical Characteristics

$V_{in} = -15V$ ,  $I_{out} = 350mA$ ,  $0^{\circ}C \leq T_j \leq 125^{\circ}C$ ,  $C_{in} = 0.33\mu F$ ,  $C_{out} = 0.1\mu F$ ; unless otherwise specified.)

Parameter	Symbol	Test Condition	Min	Typ	Max	Unit	
Output Voltage	Vout	$T_j = 25^{\circ}C$	-8.82	-9	-9.18	V	
		$-11.5V \leq V_{in} \leq -23V$ , $5mA \leq I_{out} \leq 500mA$ , $PD \leq 5W$	-8.64	-9	-9.36		
Line Regulation	REGline	$T_j = 25^{\circ}C$	$-11.5V \leq V_{in} \leq -26V$	--	6	180	mV
			$-12V \leq V_{in} \leq -17V$	--	2	90	
Load Regulation	REGload	$T_j = 25^{\circ}C$	$5mA \leq I_{out} \leq 500mA$	--	12	180	
			$250mA \leq I_{out} \leq 200mA$	--	4	90	
Quiescent Current	Iq	$I_{out} = 0$ , $T_j = 25^{\circ}C$	--	4.3	8	mA	
Quiescent Current Change	$\Delta Iq$	$-11.5V \leq V_{in} \leq -26V$	--	--	1		
		$5mA \leq I_{out} \leq 500mA$	--	--	0.5		
Output Noise Voltage	Vn	$10Hz \leq f \leq 100KHz$ , $T_j = 25^{\circ}C$	--	58	--	$\mu V$	
Ripple Rejection Ratio	RR	$f = 120Hz$ , $-12V \leq V_{in} \leq -22V$	56	71	--	dB	
Voltage Drop	Vdrop	$I_{out} = 500mA$ , $T_j = 25^{\circ}C$	--	2	--	V	
Peak Output Current	I <sub>o peak</sub>	$T_j = 25^{\circ}C$	--	0.7	--	A	
Temperature Coefficient of Output Voltage	$\Delta V_{out} / \Delta T_j$	$I_{out} = 5mA$ , $0^{\circ}C \leq T_j \leq 125^{\circ}C$	--	-1	--	$mV/^{\circ}C$	

- Pulse testing techniques are used to maintain the junction temperature as close to the ambient temperature as possible, and thermal effects must be taken into account separately.
- This specification applies only for DC power dissipation permitted by absolute maximum ratings.

# TS79M00A Series

## 3-Terminal 500mA Negative Voltage Regulator

### TS79M12A Electrical Characteristics

( $V_{in} = -19V$ ,  $I_{out} = 350mA$ ,  $0^{\circ}C \leq T_j \leq 125^{\circ}C$ ,  $C_{in} = 0.33\mu F$ ,  $C_{out} = 0.1\mu F$ ; unless otherwise specified.)

Parameter	Symbol	Test Condition	Min	Typ	Max	Unit	
Output voltage	Vout	$T_j = 25^{\circ}C$	-11.76	-12	-12.24	V	
		$-14.5V \leq V_{in} \leq -27V$ , $5mA \leq I_{out} \leq 500mA$ , $PD \leq 5W$	-11.52	-12	-12.48		
Line Regulation	REGline	$T_j = 25^{\circ}C$	$-14.5V \leq V_{in} \leq -30V$	--	10	240	mV
			$-15V \leq V_{in} \leq -19V$	--	3	120	
Load Regulation	REGload	$T_j = 25^{\circ}C$	$5mA \leq I_{out} \leq 500mA$	--	12	240	mV
			$250mA \leq I_{out} \leq 200mA$	--	4	120	
Quiescent Current	Iq	$T_j = 25^{\circ}C$ , $I_{out} = 0$	--	4.3	8	mA	
Quiescent Current Change	$\Delta Iq$	$-14.5V \leq V_{in} \leq -30V$	--	--	1		
		$5mA \leq I_{out} \leq 500mA$	--	--	0.5		
Output Noise Voltage	Vn	$10Hz \leq f \leq 100KHz$ , $T_j = 25^{\circ}C$	--	75	--	$\mu V$	
Ripple Rejection Ratio	RR	$f = 120Hz$ , $-15V \leq V_{in} \leq -25V$	55	70	--	dB	
Voltage Drop	Vdrop	$I_{out} = 500mA$ , $T_j = 25^{\circ}C$	--	2	--	V	
Peak Output Current	I <sub>o peak</sub>	$T_j = 25^{\circ}C$	--	2.1	--	A	
Temperature Coefficient of Output Voltage	$\Delta V_{out} / \Delta T_j$	$I_{out} = 5mA$ , $0^{\circ}C \leq T_j \leq 125^{\circ}C$	--	-1	--	$mV/^{\circ}C$	

### TS79M15A Electrical Characteristics

( $V_{in} = -23V$ ,  $I_{out} = 350mA$ ,  $0^{\circ}C \leq T_j \leq 125^{\circ}C$ ,  $C_{in} = 0.33\mu F$ ,  $C_{out} = 0.1\mu F$ ; unless otherwise specified.)

Parameter	Symbol	Test Condition	Min	Typ	Max	Unit	
Output Voltage	Vout	$T_j = 25^{\circ}C$	-14.70	-15	-15.30	V	
		$-17.5V \leq V_{in} \leq -30V$ , $5mA \leq I_{out} \leq 500mA$ , $PD \leq 5W$	-14.40	-15	-15.60		
Line Regulation	REGline	$T_j = 25^{\circ}C$	$-17.5V \leq V_{in} \leq -30V$	--	12	300	mV
			$-18V \leq V_{in} \leq -22V$	--	3	150	
Load Regulation	REGload	$T_j = 25^{\circ}C$	$5mA \leq I_{out} \leq 500mA$	--	12	300	mV
			$250mA \leq I_{out} \leq 200mA$	--	4	150	
Quiescent Current	Iq	$T_j = 25^{\circ}C$ , $I_{out} = 0$	--	4.3	8	mA	
Quiescent Current Change	$\Delta Iq$	$-17.5V \leq V_{in} \leq -30V$	--	--	1		
		$5mA \leq I_{out} \leq 500mA$	--	--	0.5		
Output Noise Voltage	Vn	$10Hz \leq f \leq 100KHz$ , $T_j = 25^{\circ}C$	--	90	--	$\mu V$	
Ripple Rejection Ratio	RR	$f = 120Hz$ , $-18V \leq V_{in} \leq -28V$	54	69	--	dB	
Voltage Drop	Vdrop	$I_{out} = 500mA$ , $T_j = 25^{\circ}C$	--	2	--	V	
Peak Output Current	I <sub>o peak</sub>	$T_j = 25^{\circ}C$	--	0.7	--	A	
Temperature Coefficient of Output Voltage	$\Delta V_{out} / \Delta T_j$	$I_{out} = 5mA$ , $0^{\circ}C \leq T_j \leq 125^{\circ}C$	--	-1	--	$mV/^{\circ}C$	

- Pulse testing techniques are used to maintain the junction temperature as close to the ambient temperature as possible, and thermal effects must be taken into account separately.
- This specification applies only for DC power dissipation permitted by absolute maximum ratings.

# TS79M00A Series

## 3-Terminal 500mA Negative Voltage Regulator

### TS79M18A Electrical Characteristics

( $V_{in} = -24V$ ,  $I_{out} = 350mA$ ,  $0^{\circ}C \leq T_j \leq 125^{\circ}C$ ,  $C_{in} = 0.33\mu F$ ,  $C_{out} = 0.1\mu F$ ; unless otherwise specified.)

Parameter	Symbol	Test Condition	Min	Typ	Max	Unit	
Output voltage	Vout	$T_j = 25^{\circ}C$	-17.64	-18	-18.36	V	
		$-21V \leq V_{in} \leq -33V$ , $5mA \leq I_{out} \leq 500mA$ , $PD \leq 5W$	-17.28	-18	-18.72		
Line Regulation	REGline	$T_j = 25^{\circ}C$	$-21V \leq V_{in} \leq -33V$	--	15	360	mV
			$-22V \leq V_{in} \leq -26V$	--	5	180	
Load Regulation	REGload	$T_j = 25^{\circ}C$	$5mA \leq I_{out} \leq 500mA$	--	12	360	mV
			$250mA \leq I_{out} \leq 200mA$	--	4	180	
Quiescent Current	Iq	$I_{out} = 0$ , $T_j = 25^{\circ}C$	--	4.5	8	mA	
Quiescent Current Change	$\Delta Iq$	$-21V \leq V_{in} \leq -33V$	--	--	1		
		$5mA \leq I_{out} \leq 500mA$	--	--	0.5		
Output Noise Voltage	Vn	$10Hz \leq f \leq 100KHz$ , $T_j = 25^{\circ}C$	--	110	--	$\mu V$	
Ripple Rejection Ratio	RR	$f = 120Hz$ , $-21V \leq V_{in} \leq -31V$	53	68	--	dB	
Voltage Drop	Vdrop	$I_{out} = 500mA$ , $T_j = 25^{\circ}C$	--	2	--	V	
Peak Output Current	I <sub>o peak</sub>	$T_j = 25^{\circ}C$	--	0.7	--	A	
Temperature Coefficient of Output Voltage	$\Delta V_{out} / \Delta T_j$	$I_{out} = 5mA$ , $0^{\circ}C \leq T_j \leq 125^{\circ}C$	--	-1	--	$mV/^{\circ}C$	

### TS79M24A Electrical Characteristics

( $V_{in} = -33V$ ,  $I_{out} = 350mA$ ,  $0^{\circ}C \leq T_j \leq 125^{\circ}C$ ,  $C_{in} = 0.33\mu F$ ,  $C_{out} = 0.1\mu F$ ; unless otherwise specified.)

Parameter	Symbol	Test Condition	Min	Typ	Max	Unit	
Output Voltage	Vout	$T_j = 25^{\circ}C$	-23.52	-24	-24.48	V	
		$-27V \leq V_{in} \leq -38V$ , $5mA \leq I_{out} \leq 500mA$ , $PD \leq 5W$	-23.07	-24	-25.96		
Line Regulation	REGline	$T_j = 25^{\circ}C$	$-27V \leq V_{in} \leq -38V$	--	18	480	mV
			$-28V \leq V_{in} \leq -32V$	--	6	240	
Load Regulation	REGload	$T_j = 25^{\circ}C$	$5mA \leq I_{out} \leq 500mA$	--	12	480	mV
			$250mA \leq I_{out} \leq 200mA$	--	4	240	
Quiescent Current	Iq	$I_{out} = 0$ , $T_j = 25^{\circ}C$	--	4.6	8	mA	
Quiescent Current Change	$\Delta Iq$	$-27V \leq V_{in} \leq -38V$	--	--	1		
		$5mA \leq I_{out} \leq 500mA$	--	--	0.5		
Output Noise Voltage	Vn	$10Hz \leq f \leq 100KHz$ , $T_j = 25^{\circ}C$	--	170	--	$\mu V$	
Ripple Rejection Ratio	RR	$f = 120Hz$ , $-27V \leq V_{in} \leq -37V$	50	65	--	dB	
Voltage Drop	Vdrop	$I_{out} = 500mA$ , $T_j = 25^{\circ}C$	--	2	--	V	
Peak Output Current	I <sub>o peak</sub>	$T_j = 25^{\circ}C$	--	0.7	--	A	
Temperature Coefficient of Output Voltage	$\Delta V_{out} / \Delta T_j$	$I_{out} = 5mA$ , $0^{\circ}C \leq T_j \leq 125^{\circ}C$	--	-1	--	$mV/^{\circ}C$	

- Pulse testing techniques are used to maintain the junction temperature as close to the ambient temperature as possible, and thermal effects must be taken into account separately.
- This specification applies only for DC power dissipation permitted by absolute maximum ratings.

# TS79M00A Series

## 3-Terminal 500mA Negative Voltage Regulator

### Electrical Characteristics Curve

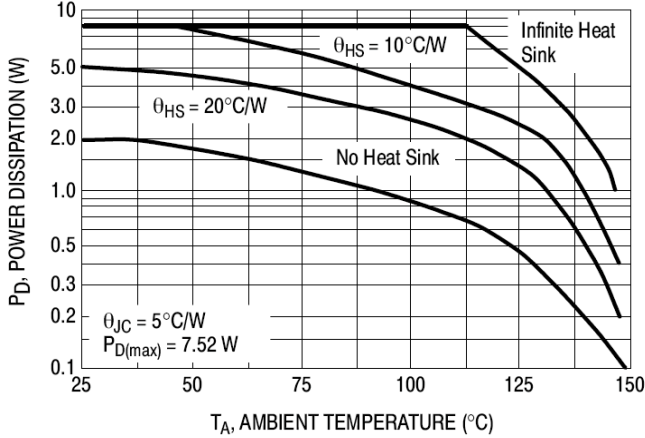

**Figure 1. Worst Case Power Dissipation vs. Ambient Temperature (TO-220)**

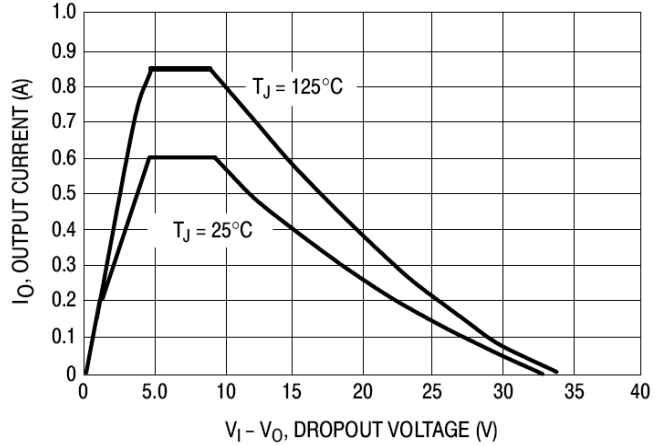

**Figure 2. Peak Output Current as a Function of Input-Output Differential Voltage**

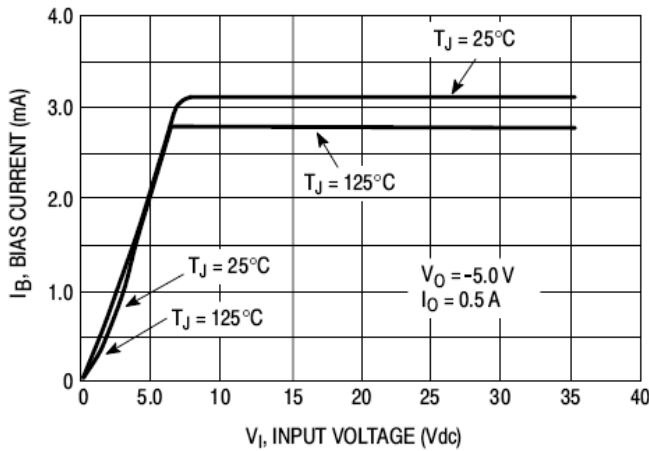

**Figure 3. Bias Current vs. Input Voltage**

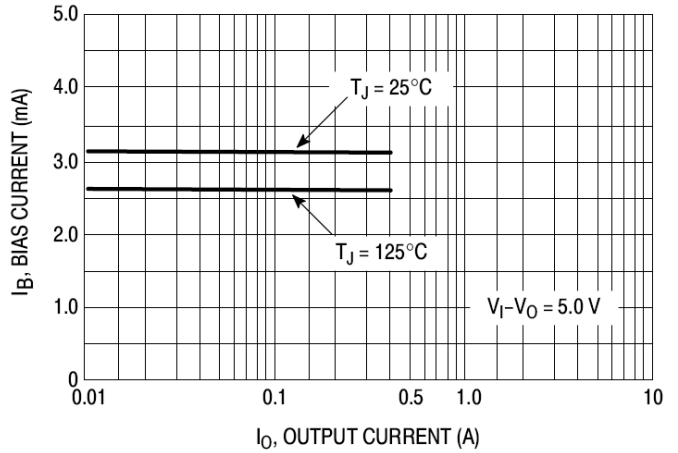

**Figure 4. Bias Current vs. Output Current**

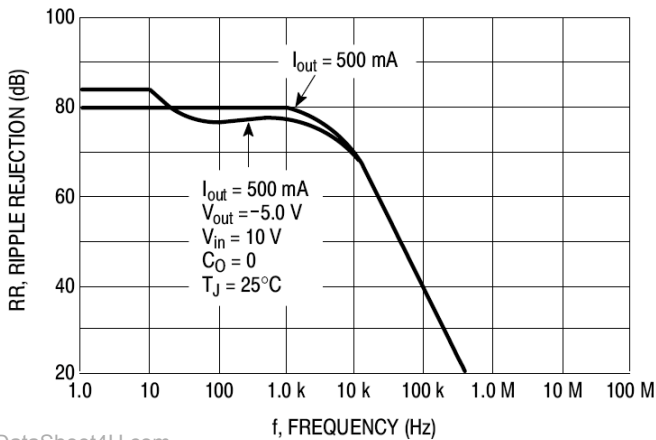

**Figure 5. Ripple Rejection vs. Frequency**

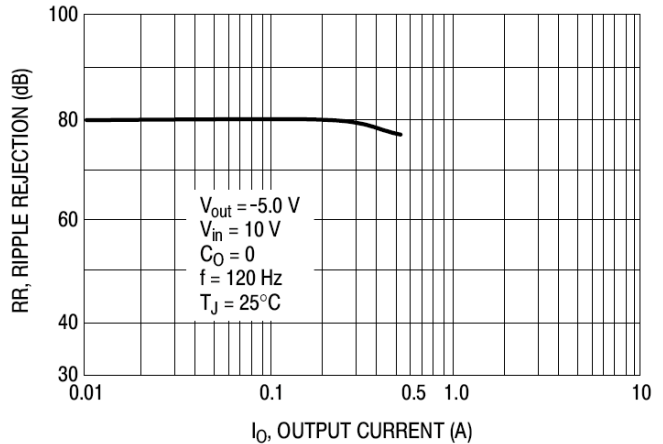
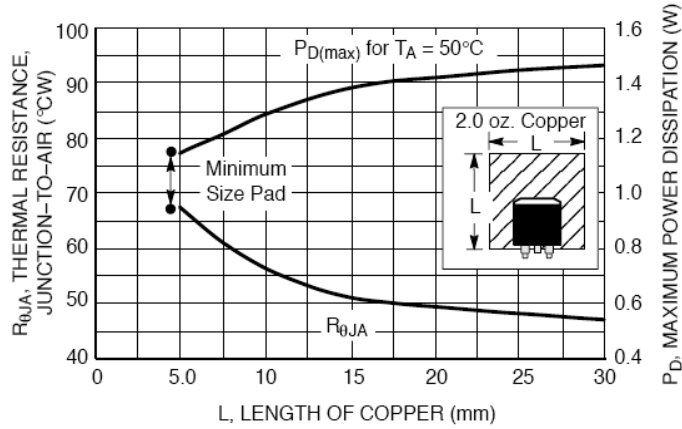

**Figure 6. Ripple Rejection vs. Output Voltage**

# TS79M00A Series

## 3-Terminal 500mA Negative Voltage Regulator

### Application information

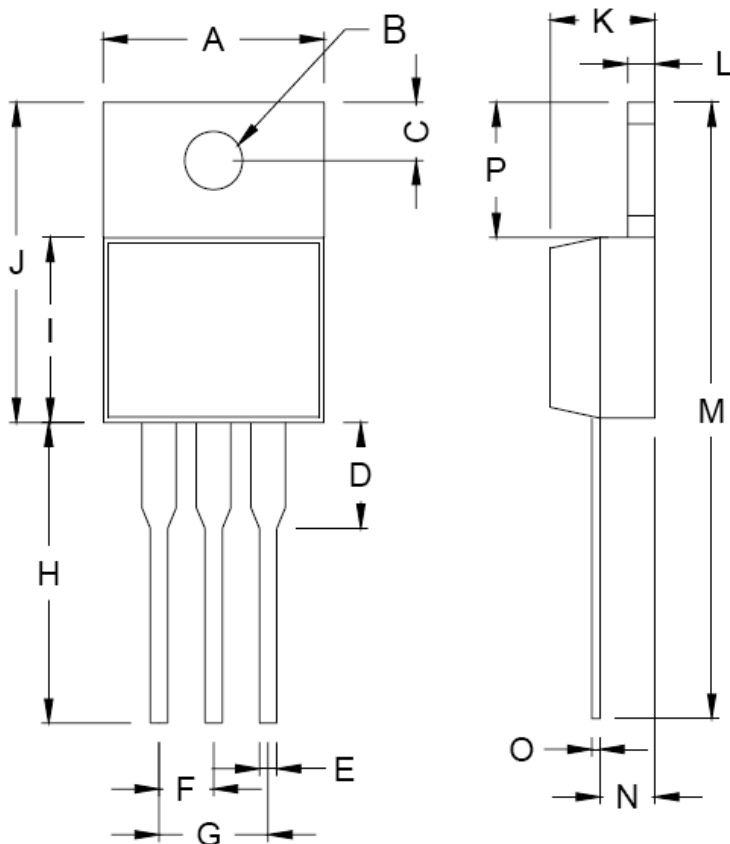

**Figure 7. DPAK Thermal Resistance and Maximum Power Dissipation vs. P.C.B Copper Length**

# TS79M00A Series

## 3-Terminal 500mA Negative Voltage Regulator

### TO-220 Mechanical Drawing



TO-220 DIMENSION				
DIM	MILLIMETERS		INCHES	
	MIN	MAX	MIN	MAX
A	10.000	10.500	0.394	0.413
B	3.740	3.910	0.147	0.154
C	2.440	2.940	0.096	0.116
D	-	6.350	-	0.250
E	0.381	1.106	0.015	0.040
F	2.345	2.715	0.092	0.058
G	4.690	5.430	0.092	0.107
H	12.700	14.732	0.500	0.581
I	8.382	9.017	0.330	0.355
J	14.224	16.510	0.560	0.650
K	3.556	4.826	0.140	0.190
L	0.508	1.397	0.020	0.055
M	27.700	29.620	1.060	1.230
N	2.032	2.921	0.080	0.115
O	0.255	0.610	0.010	0.024
P	5.842	6.858	0.230	0.270

### Marking Diagram

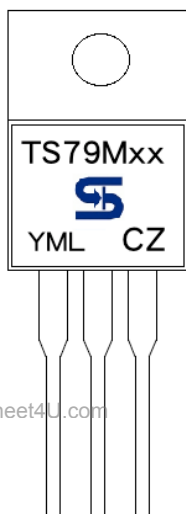

- XX** = Output Voltage  
(05=-5V, 06=-6V, 08=-8V, 09=-9V, 12=-12V, 15=-15V, 18=-18V, 24=-24V)
- Y** = Year Code
- M** = Month Code  
(**A**=Jan, **B**=Feb, **C**=Mar, **D**=Apr, **E**=May, **F**=Jun, **G**=Jul, **H**=Aug, **I**=Sep, **J**=Oct, **K**=Nov, **L**=Dec)
- L** = Lot Code
- CZ** = Package Code for TO-220



# TS79M00A Series

## 3-Terminal 500mA Negative Voltage Regulator

### TO-252 Mechanical Drawing

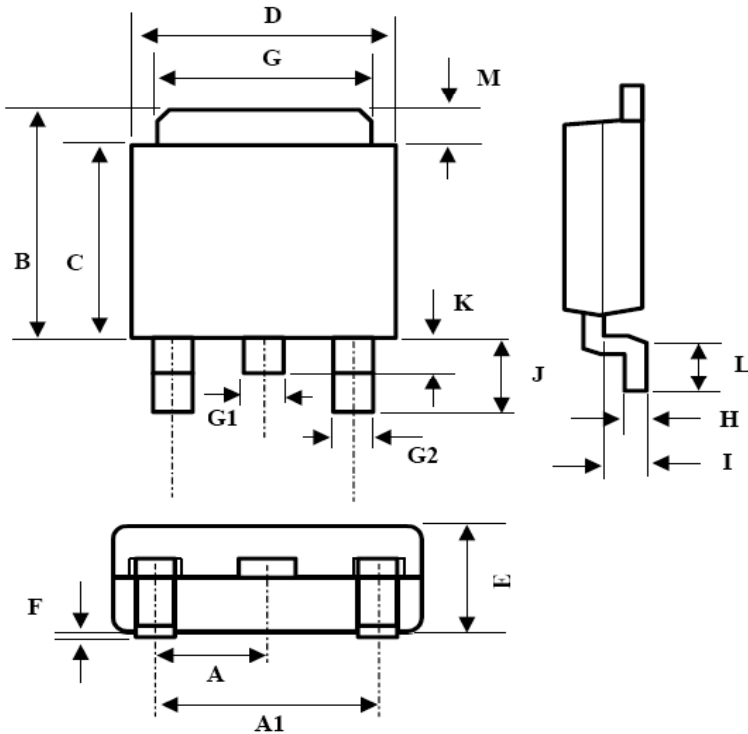

DIM	TO-252 DIMENSION			
	MILLIMETERS		INCHES	
	MIN	MAX	MIN	MAX
A	2.3BSC		0.09BSC	
A1	4.6BSC		0.18BSC	
B	6.80	7.20	0.268	0.283
C	5.40	5.60	0.213	0.220
D	6.40	6.65	0.252	0.262
E	2.20	2.40	0.087	0.094
F	0.00	0.20	0.000	0.008
G	5.20	5.40	0.205	0.213
G1	0.75	0.85	0.030	0.033
G2	0.55	0.65	0.022	0.026
H	0.35	0.65	0.014	0.026
I	0.90	1.50	0.035	0.059
J	2.20	2.80	0.087	0.110
K	0.50	1.10	0.020	0.043
L	0.90	1.50	0.035	0.059
M	1.30	1.70	0.051	0.67

### Marking Diagram

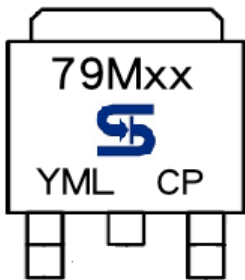

- XX** = Output Voltage  
(05=-5V, 06=-6V, 08=-8V, 09=-9V, 12=-12V, 15=-15V, 18=-18V, 24=-24V)
- Y** = Year Code
- M** = Month Code  
(**A**=Jan, **B**=Feb, **C**=Mar, **D**=Apr, **E**=May, **F**=Jun, **G**=Jul, **H**=Aug, **I**=Sep, **J**=Oct, **K**=Nov, **L**=Dec)
- L** = Lot Code
- CP** = Package Code for TO-252



# TS79M00A Series

## 3-Terminal 500mA Negative Voltage Regulator

### Notice

Specifications of the products displayed herein are subject to change without notice. TSC or anyone on its behalf, assumes no responsibility or liability for any errors or inaccuracies.

Information contained herein is intended to provide a product description only. No license, express or implied, to any intellectual property rights is granted by this document. Except as provided in TSC's terms and conditions of sale for such products, TSC assumes no liability whatsoever, and disclaims any express or implied warranty, relating to sale and/or use of TSC products including liability or warranties relating to fitness for a particular purpose, merchantability, or infringement of any patent, copyright, or other intellectual property right.

The products shown herein are not designed for use in medical, life-saving, or life-sustaining applications. Customers using or selling these products for use in such applications do so at their own risk and agree to fully indemnify TSC for any damages resulting from such improper use or sale.