

EVALPM8803-FLY: IEEE802.3at compliant demonstration kit with synchronous flyback converter

By Antonio Rotta

Introduction

The PM8803 is a highly integrated device embedding an IEEE802.3at-2009 compliant powered device (PD) interface together with a PWM controller and support for auxiliary sources. [Figure 1](#) is an image of the EVALPM8803-FLY PoE+ demonstration board. The same PCB can be populated with different components to support various configurations and topologies (synchronous flyback with or without active clamp, flyback with diode rectification).

This document focuses on a reference design for PoE+ based on flyback topology with synchronous rectification, with the PM8803 as the main controller.

The schematics and board layout of the PoE+ converter are given in [Section 2](#) and [3](#) while the related bill of material is detailed in [Section 5](#). In [Section 7](#) efficiency measurements together with main waveforms of the PoE interface and flyback converter are shown.

Figure 1. EVALPM8803-FLY demonstration kit

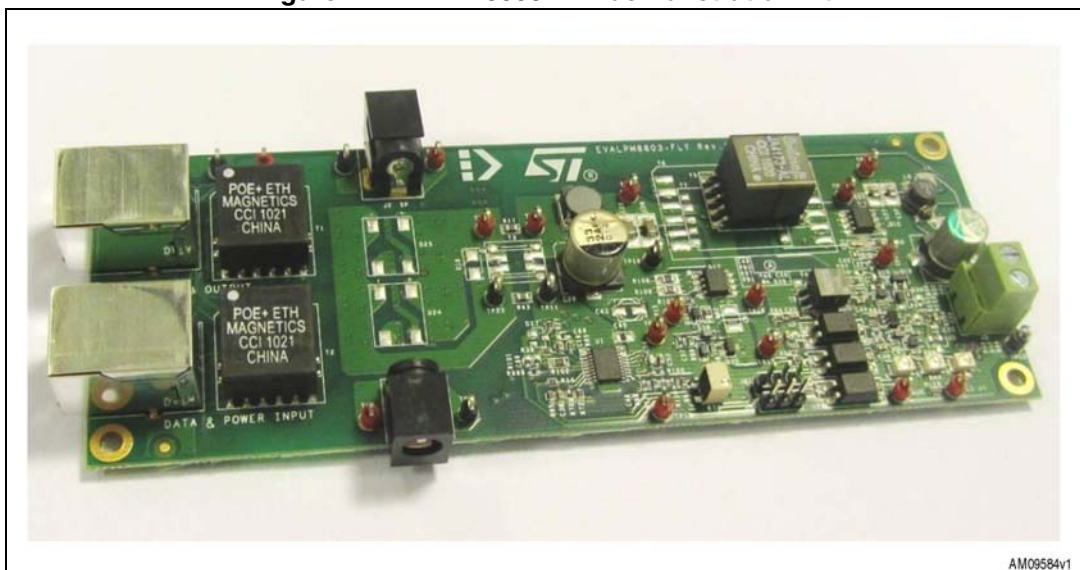

Contents

1	Electrical specifications	5
2	Demonstration kit schematic	6
3	Board layout	8
4	I/O connectors and test points	11
5	Bill of material	13
6	Power-up sequence	19
7	Test results	20
7.1	Efficiency measurement with 3.3 V output	20
7.2	Efficiency measurements with 5 V output	21
7.3	Waveforms	23
7.3.1	Startup sequence from PoE/PoE+ injectors	23
7.3.2	Transition from PoE to auxiliary and auxiliary to PoE	24
7.3.3	Primary side MOSFET	25
7.3.4	Secondary side MOSFET	26
7.3.5	Line transient	28
7.3.6	Load transient	29
7.3.7	Output ripple	30
8	Revision history	31

List of tables

Table 1.	Specifications for 3.3 V output	5
Table 2.	Specifications for 5 V output	5
Table 3.	Connectors	11
Table 4.	LEDs	11
Table 5.	Test points	11
Table 6.	EVALPM8803-FWD BOM	13
Table 7.	Document revision history	31

List of figures

Figure 1.	EVALPM8803-FLY demonstration kit	1
Figure 2.	Demonstration kit schematic: detail of the PoE+ input section including data transformer, diode bridges, protection, and optional CM choke	6
Figure 3.	Demonstration kit schematic: detail of the PoE+ section based on flyback topology with synchronous rectification	7
Figure 4.	Assembly view: top layer	8
Figure 5.	Assembly view: bottom layer	8
Figure 6.	Top layer	9
Figure 7.	Inner layer 1	9
Figure 8.	Inner layer 2	10
Figure 9.	Bottom layer	10
Figure 10.	Efficiency measurements at 48 V input	20
Figure 11.	DC-DC only efficiency measurements	20
Figure 12.	Overall efficiency measurements	21
Figure 13.	Efficiency measurements at 48 V input	21
Figure 14.	DC-DC only efficiency measurements	22
Figure 15.	Overall efficiency measurements	22
Figure 16.	Startup from an IEEE 802.3af injector with 2 A load.	23
Figure 17.	Startup from an IEEE 802.3at injector with 4 A load.	23
Figure 18.	Switching between PoE and auxiliary source	24
Figure 19.	Primary side power MOSFET waveforms at 0 A load.	25
Figure 20.	Primary side power MOSFET waveforms at 4 A load.	25
Figure 21.	Details of primary side power MOSFET waveforms at 4 A load.	26
Figure 22.	Secondary side power MOSFET waveforms at 0 A load	26
Figure 23.	Secondary side power MOSFET waveforms at 4 A load	27
Figure 24.	Effect of a 12 V line transient on the converter at 4 A load.	28
Figure 25.	Effect of a 12 V line transient on the converter at 0 A load.	28
Figure 26.	Response of the converter to a 2 A - 4 A load transient	29
Figure 27.	Response of the converter to a 0 A - 4 A load transient	29
Figure 28.	Output ripple measurement at 4 A	30
Figure 29.	Output ripple measurement at 4 A with infinite persistence	30

1 Electrical specifications

Table 1. Specifications for 3.3 V output

Parameter	Description	Min.	Typ.	Max.	Unit
Input voltage range	Applied at J3 connector	0		57	V
Operative input voltage		42		57	V
UVLO	Vin rising edge			36	V
	Vin falling edge	30			V
Auxiliary input voltage range		35		60	V
Output voltage (Vout)	Vin= 42 V to 57 V, Iout 0 to Imax	3.25	3.35	3.45	V
Output current (Iout)	Vin= 42 V to 57 V	0		6	A
Peak-to-peak output ripple	48 Vin, Iout=Imax		20	30	mVpp
Inrush current limit			140		mA
DC current limit			640		mA
3.3 V efficiency DC-DC only	Vin=48 V, Iout=Imax		90		%
3.3 V overall efficiency	Vin=48 V, Iout=Imax		87		%
Switching frequency			200		kHz

Table 2. Specifications for 5 V output

Parameter	Description	Min.	Typ.	Max.	Unit
Input voltage range	Applied at J3 connector	0		57	V
Operative input voltage		42		57	V
UVLO	Vin rising edge			36	V
	Vin falling edge	30			V
Auxiliary input voltage range		35		60	V
Output voltage (Vout)	Vin= 42 V to 57 V, Iout 0 to Imax	4.95	5.1	5.25	V
Output current (Iout)	Vin= 42 V to 57 V	0		4	A
Peak-to-peak output ripple	48Vin, Iout=Imax		20	30	mVpp
Inrush current limit			140		mA
DC current limit			640		mA
5 V efficiency DC-DC only	Vin=48 V, Iout=Imax		92		%
5 V overall efficiency	Vin=48 V, Iout=Imax		89		%
Switching frequency			200		kHz

2 Demonstration kit schematic

Figure 2. Demonstration kit schematic: detail of the PoE+ input section including data transformer, diode bridges, protection, and optional CM choke

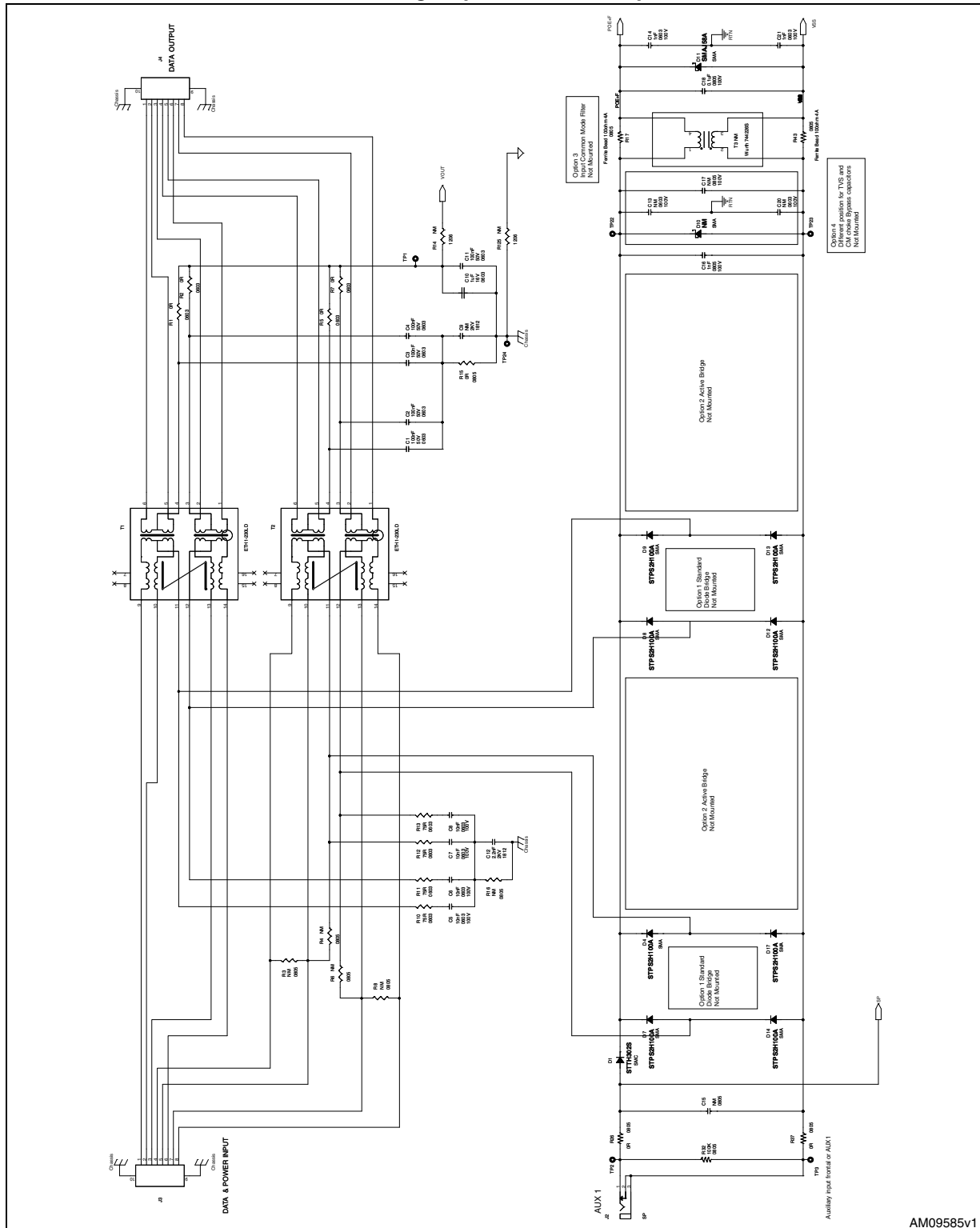
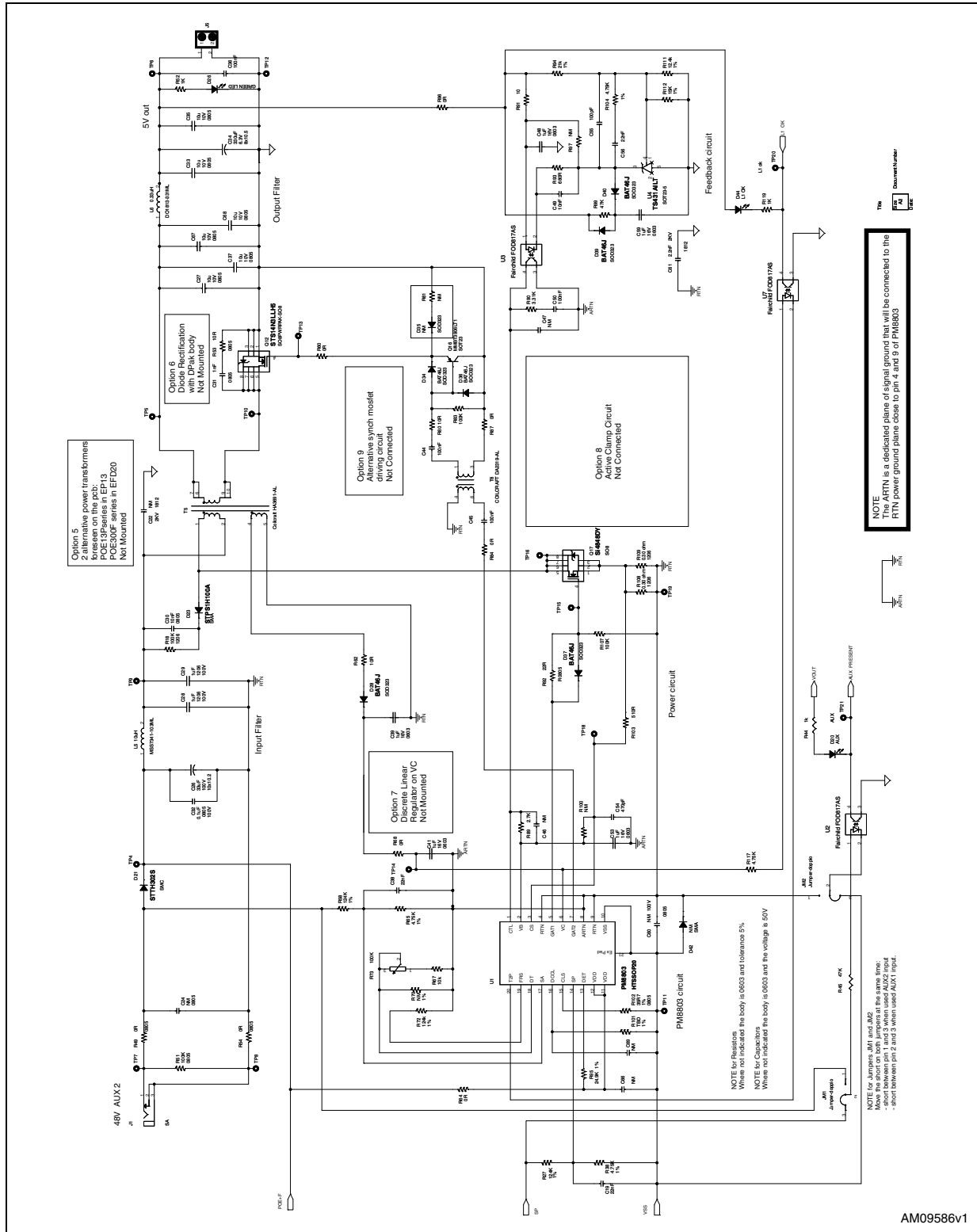

Figure 3. Demonstration kit schematic: detail of the PoE+ section based on flyback topology with synchronous rectification



AM09586v1

3 Board layout

Board size: 10 x 16 cm. Layer copper thickness: 70 micron.

Figure 4. Assembly view: top layer

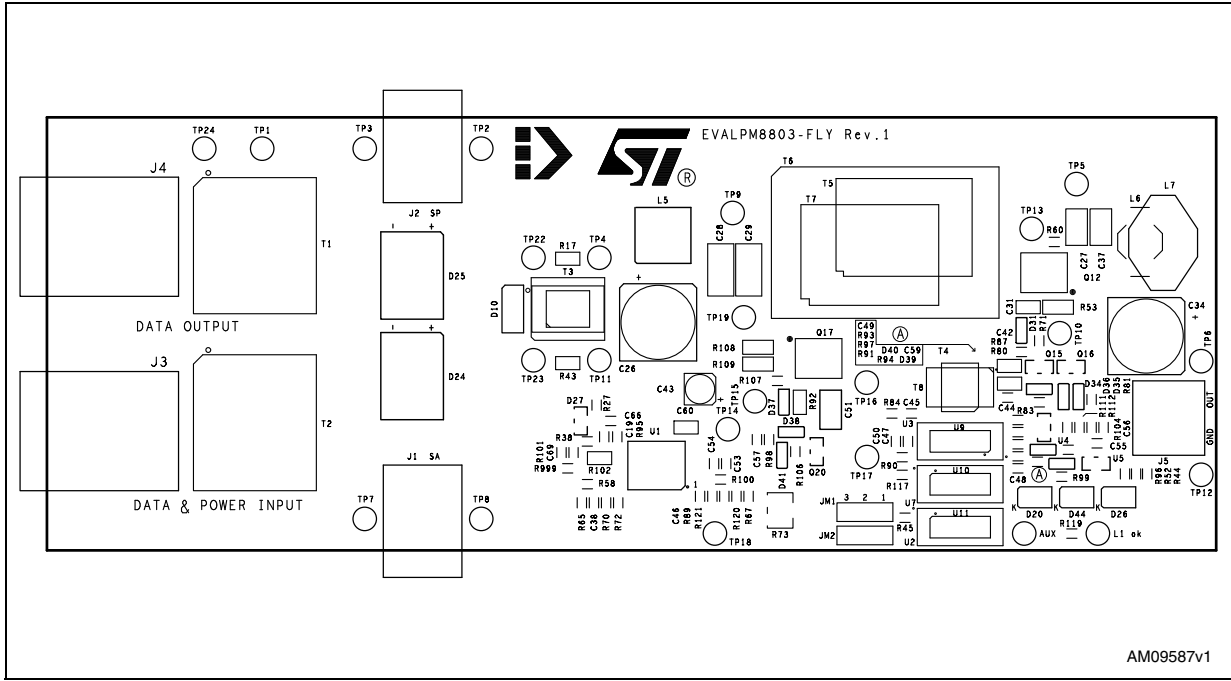

Figure 5. Assembly view: bottom layer

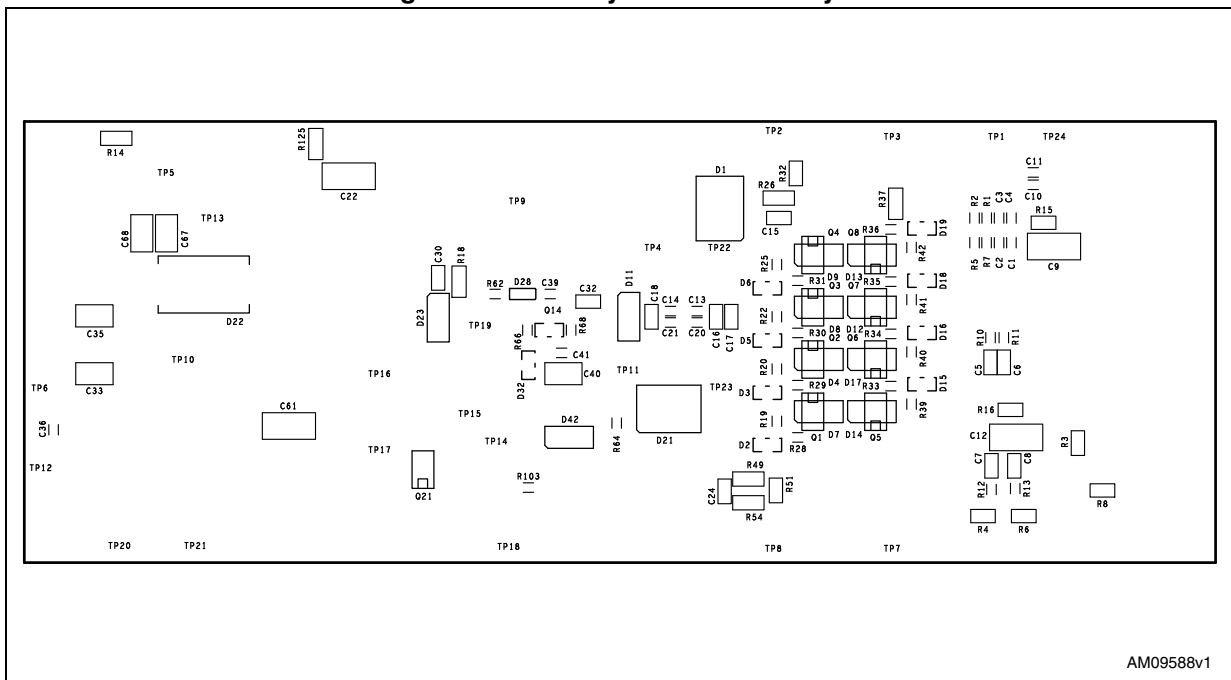
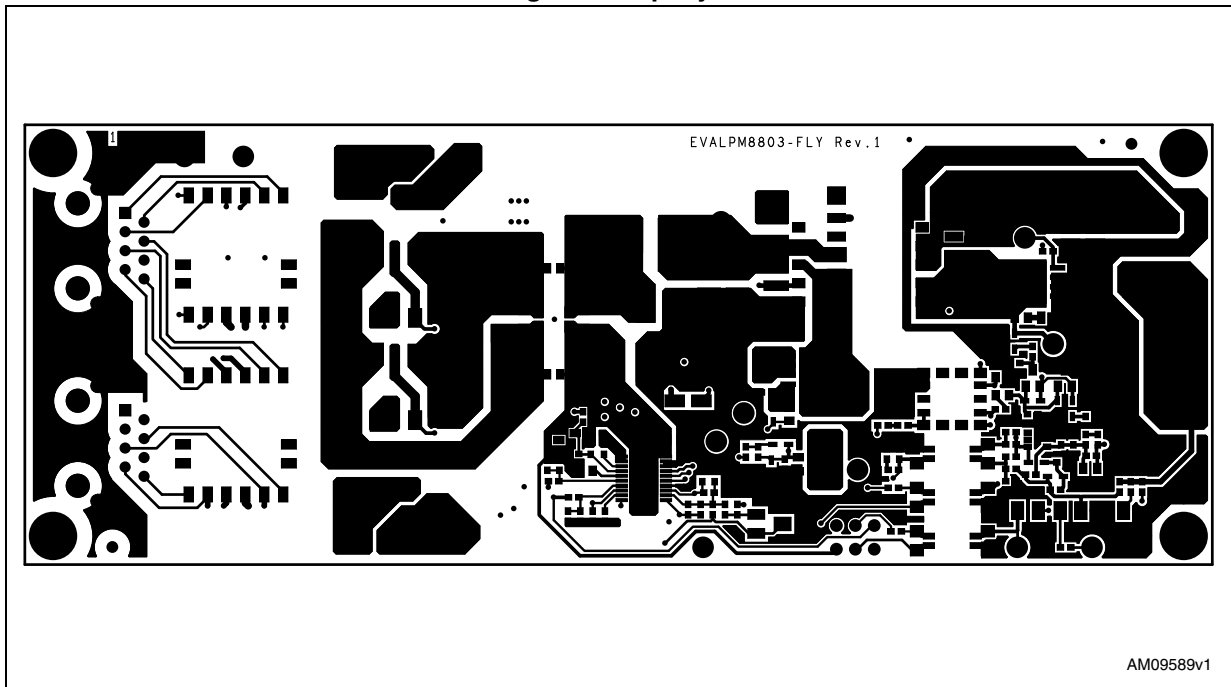
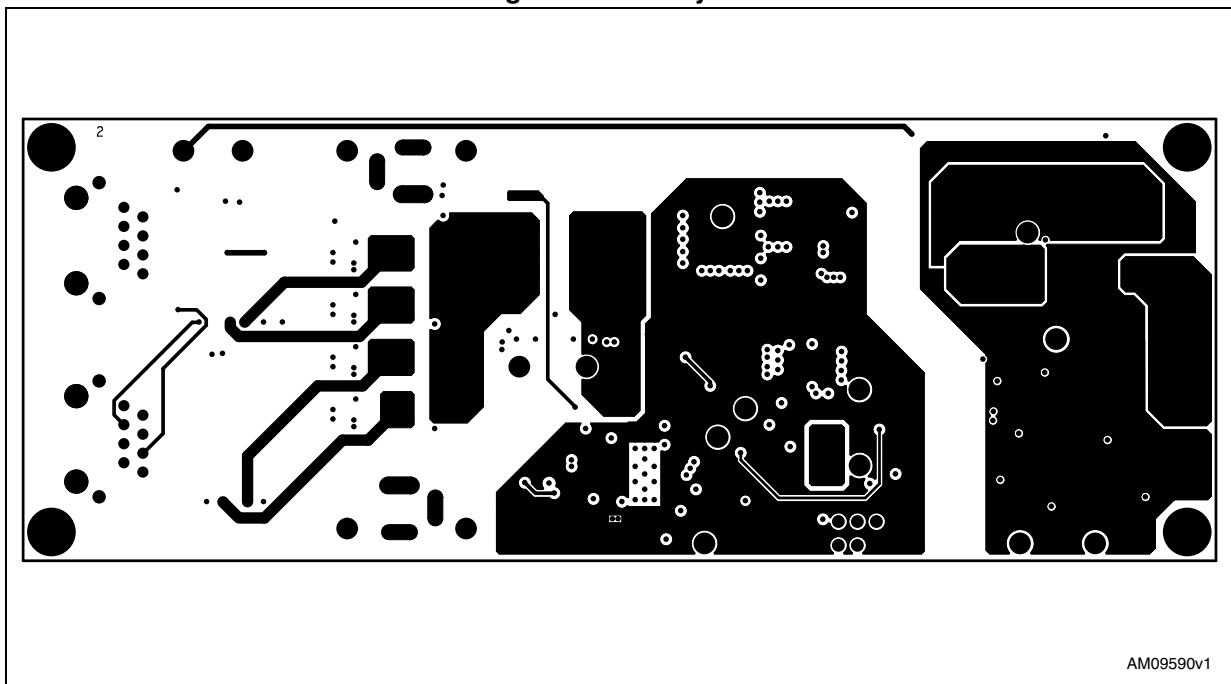

Figure 6. Top layer



AM09589v1

Figure 7. Inner layer 1



AM09590v1

Figure 8. Inner layer 2

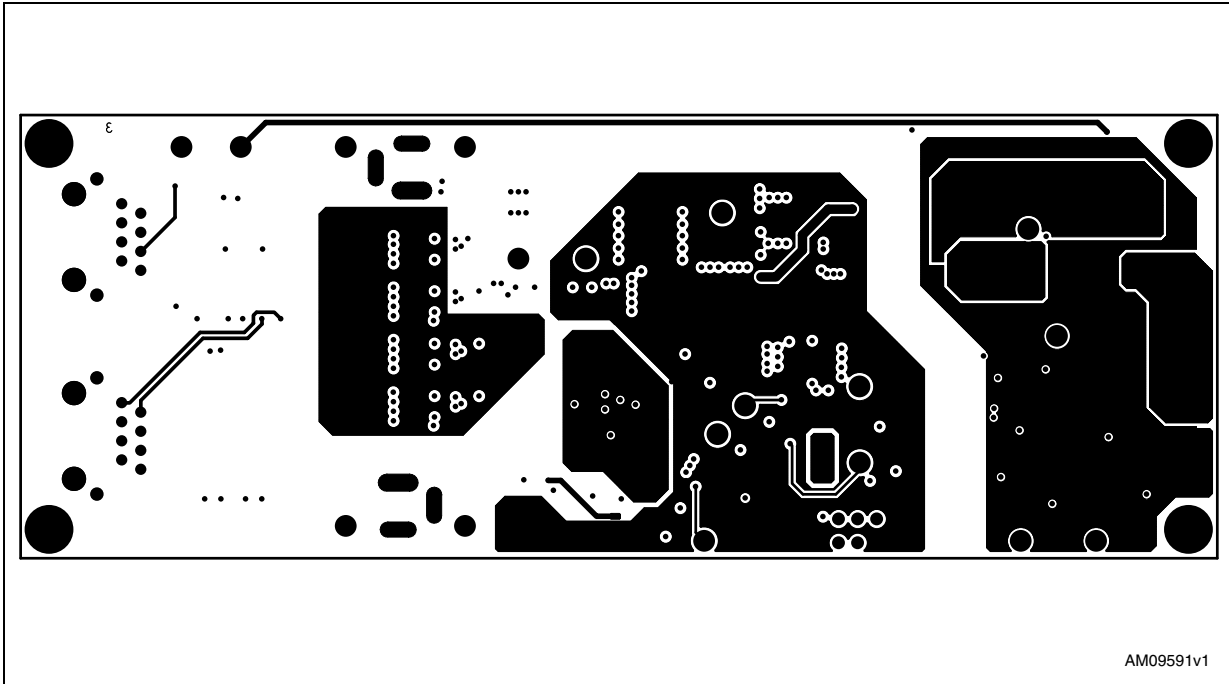
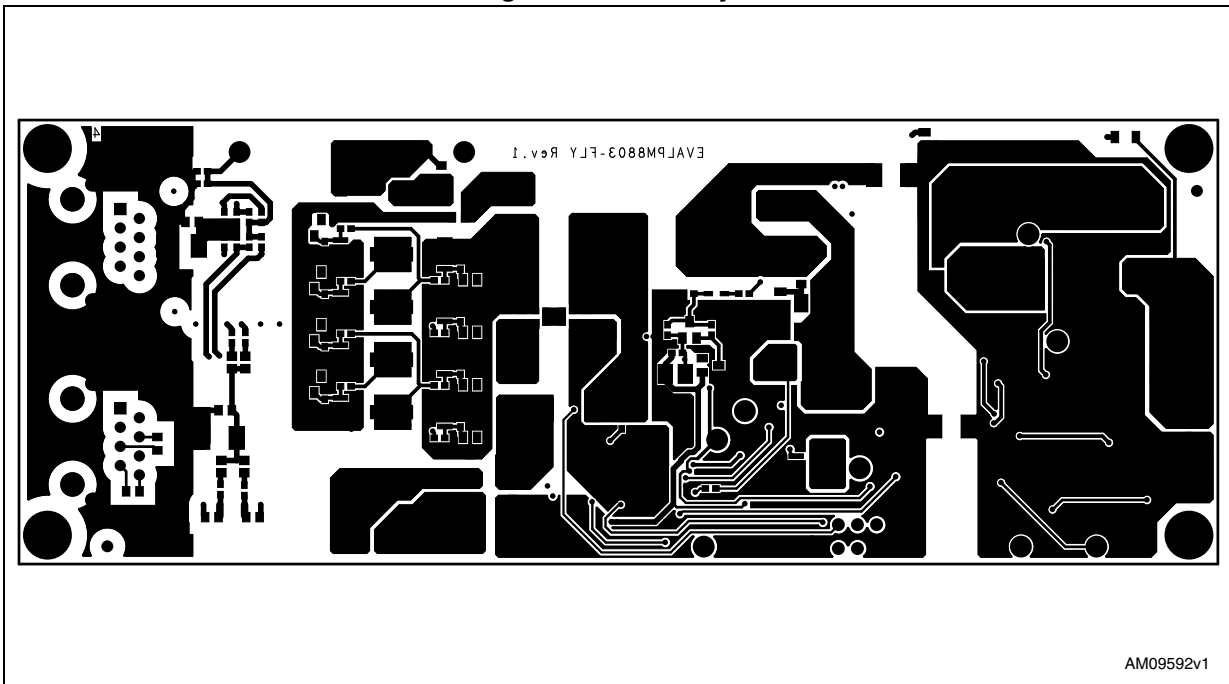

Figure 9. Bottom layer



4 I/O connectors and test points

This section provides a description of input/output connectors ([Table 3](#)), LED indicators and commands ([Table 4](#)), as well as the available test points ([Table 5](#)).

Table 3. Connectors

Connector	Label	Description
J3	Data and power input	Power and Ethernet data input port
J4	Data output	Ethernet data output port
J2	SP	Wall adapter input. Use this input jack to connect auxiliary source without priority in respect to PoE.
J1	SA	Wall adapter input. Use this input jack to connect auxiliary source with priority in respect to PoE.
J5	-	Output voltage connector
JM1	-	Move the short on both jumpers at the same time: short between pin 1 and 2 when SA auxiliary source is used on J1 connector; short between pin 2 and 3 when SP auxiliary source is used on J2 connector
JM2	-	Move the short on both jumpers at the same time: short between pin 1 and 2 when SA auxiliary source is used on J1 connector; short between pin 2 and 3 when SP auxiliary source is used on J2 connector

Table 4. LEDs

LED	Label	Description
D20	AUX	ON when an auxiliary source is applied to the board; proper selection of the auxiliary source connection is done with jumpers JM1 and JM2
D44	L1_OK	ON when T2P is asserted. This is achieved when a 2-finger event is detected. If, after a successful PoE+ layer-1 classification, an auxiliary voltage is connected, the T2P signal is de-asserted and the L1_OK LED is turned off.
D26	GREEN LED	ON when output voltage is present.

Table 5. Test points

Test point	Color	Description
TP1	Red	Data transformer bias voltage
TP2	Red	Positive of auxiliary source AUX 1 on J2
TP3	Black	Ground of auxiliary source AUX 1 on J2

Table 5. Test points (continued)

Test point	Color	Description
TP4	Red	Input voltage VDD
TP5	Red	Secondary winding output
TP6	Red	Output voltage at J5
TP7	Red	Positive of auxiliary source AUX 2 on J1
TP8	Black	Ground of auxiliary source AUX 2 on J1
TP9	Red	Input of the primary side winding
TP10	Red	Secondary winding output
TP11	Red	VSS - I/F ground voltage
TP12	Black	Output voltage ground at J5
TP13	Red	Gate drive of the secondary side MOSFET
TP14	Red	VC supply voltage
TP15	Red	Gate drive of the primary side MOSFET (connected to GAT1)
TP16	Red	Drain of the primary side MOSFET
TP17	Red	Gate drive of the active clamp MOSFET (connected to GAT2)
TP18	Red	Current sense input
TP19	Black	RTN - DC-DC ground voltage
TP20	Red	L1 status indicator - referred to output voltage ground
TP21	Red	Aux present indicator - referred to output voltage ground
TP22	Red	PoE voltage after the input diode bridges
TP23	Black	Ground of the PoE voltage after the input diode bridges
TP24	Black	Chassis ground of the RJ45 connectors



5 Bill of material

Table 6 shows the bill of material for the PoE+ section based on the PM8803 configured in flyback topology with synchronous rectification using a gatedriver transformer.

With minimal BOM changes it is possible to switch from 3.3 V to 5 V output voltage.

Table 6. EVALPM8803-FWD BOM

3.3 V	5 V	Reference	Description	Value	Tol.	Voltage	Body	Vendor
1	1	EVALPM8803 FLY rev1	Board PCB					
8	8	C1,C2,C3,C4,C11C36, C44,C45	Ceramic capacitor	100 nF		50 V	603	Std
5	5	C5,C6,C7,C8,C30	Ceramic capacitor	10 nF	10%	100 V	603	TDK
NM	NM	C9,C22	Ceramic capacitor	NM			1812	NM
6	6	C10,C39,C41,C48C53, C59	Ceramic capacitor	1 μ F	20%	16 V	603	Std
1	1	C12	Ceramic capacitor	2.2 nF		2 kV	1812	TDK
NM	NM	C13,C20	Ceramic capacitor	NM		100 V	603	NM
3	3	C14,C16,C21	Ceramic capacitor	1 nF	10%	100 V	603	TDK
NM	NM	C15,C17,C24,C60	Ceramic capacitor	NM		100 V	805	NM
2	2	C18,C32	Ceramic capacitor	0.1 μ F	10%	100 V	805	TDK
2	2	C19,C38	Ceramic capacitor	22 nF		50 V	603	Std
NM	NM	C42,C46,C57,C66C69	Ceramic capacitor	NM			603	NM
1	1	C26	Aluminium capacitor	33 μ F	20%	100 V	10x10.2	Std
6	6	C27,C33,C35,C37C67, C68	Ceramic capacitor	10 μ F	20%	6.3 V	805	Std
2	2	C28,C29	Ceramic capacitor	1 μ F	20%	100 V	1206	TDK
1	1	C31	Ceramic capacitor	1 nF	10%	100 V	805	Std
1	1	C34	Aluminium capacitor	330 μ F		6.3 V	8x10.5	Suncon



Table 6. EVALPM8803-FWD BOM (continued)

3.3 V	5 V	Reference	Description	Value	Tol.	Voltage	Body	Vendor
NM	NM	C40	Ceramic capacitor	NM			805	NM
NM	NM	C43	Aluminium capacitor	NM			4x6	NM
NM	NM	C47	Ceramic capacitor	NM			603	NM
1	1	C49	Ceramic capacitor	10 nF		50 V	603	Std
1	1	C50	Ceramic capacitor	100 nF		50 V	603	Std
NM	NM	C51	Ceramic capacitor	NM			1206	NM option AC
1	1	C54	Ceramic capacitor	470 pF		50 V	603	Std
1	1	C55	Ceramic capacitor	100 pF		50 V	603	Std
1	1	C56	Ceramic capacitor	22 nF		50 V	603	Std
1	1	C61	Ceramic capacitor	2.2 nF		2 kV	1812	TDK
1	1	D1, D21	Std diode	STTH302S		200 V	SMC	ST
NM	NM	D2,D3,D5,D6,D15D16, D18,D19	Zener diode	(BZX84C10)			SOT23	NM
1	1	D32	Zener diode	BZX84C10			SOT23	Std
8	8	D4,D7,D8,D9,D12D13, D14, D17	Schottky diode	STPS2H100A		100 V	SMA	ST
NM	NM	D10	TVS diode	NM			SMA	NM
1	1	D11	TVS diode	SMAJ58A			SMA	ST
1	1	D20	LED diode	AUX		2.2 V	PLCC-2	Std
NM	NM	D22	Schottky diode	(STPS15L45CB)			DPAK	NM
1	1	D23	Schottky diode	STPS1H100A		100 V	SMA	ST
NM	NM	D24,D25	Bridge rectifier	NM			SDIP	NM
1	1	D26	LED diode	Green LED		2.2 V	PLCC-2	Std
NM	NM	D27	Zener diode	NM			SOT23	NM
6	6	D28,D34,D36,D37D39, D41	Schottky diode	BAT46J		100 V	SOD323	ST



Table 6. EVALPM8803-FWD BOM (continued)

3.3 V	5 V	Reference	Description	Value	Tol.	Voltage	Body	Vendor
2	2	D38, D41	Schottky diode	BAT46J		100 V	SOD323	ST option AC
NM	NM	D31,D35	Schottky diode	NM			SOD323	NM
NM	NM	D42	Schottky diode	NM			SMA	NM
1	1	D44	LED diode	L1 OK		2.2 V	PLCC-2	Std
2	2	JM1,JM2	Connector	Jumper 3 pins male			Pitch 2.54 mm	Std
2	2	Jumper	Jumper	Jumper 2 pins female			Pitch 2.54 mm	Std
2	2	J1,J2	Power jack	SA, SP				Std
1	1	J3	RJ45 connector	Data and power input				Std
1	1	J4	RJ45 connector	Data output				Std
1	1	J5	Terminal block 2-way	MOR-10X10.5-P5-2PIN				Std
1	1	L5	SMT inductor	10 μ H			MSS7341-103ML	Coilcraft
1	1	L6	SMT inductor	0.33 μ H			DO1813-331ML	Coilcraft
NM	NM	L7	SMT inductor					NM
NM	NM	Q1,Q2,Q3,Q4	MOSFET, P-ch	(IRF6216PbF)			SO8	NM
NM	NM	Q5,Q6,Q7,Q8	MOSFET, N-ch	(STS4NF100)			SO8	NM
1	1	Q12	MOSFET, N-ch	STS14N3LLH5		30 V	SO8	ST
1	1	Q14	Transistor, NPN	MMBT3904LT1		40 V	SOT23	Std
1	1	Q16	Transistor, PNP	MMBT3906LT1		40 V	SOT23	Std
1	1	Q17	MOSFET, N-ch	Si4848DY		150 V	SO8	Vishay
1	1	Q20	MOSFET, P-ch	Si2325DS		150 V	SOT23	Option AC
NM	NM	Q21	MOSFET, P-ch	IRF6216PbF		150 V	SO8	NM
4	4	R1,R2,R5,R7	Chip resistor	0			603	Std
NM	NM	R3,R4,R6,R8,R16	Chip resistor	NM			805	NM
4	4	R10,R11,R12,R13	Chip resistor	75 Ω			603	Std
NM	NM	R14,R125	Chip resistor	NM			1206	NM



Table 6. EVALPM8803-FWD BOM (continued)

3.3 V	5 V	Reference	Description	Value	Tol.	Voltage	Body	Vendor
1	1	R15	Chip resistor	0			805	Std
2	2	R17,R43	Ferrite bead	MPZ012101A		100 Ω , 4 A	805	TDK
1	1	R18	Chip resistor	100 k Ω			1206	Std
NM	NM	R19,R20,R22,R25R39, R40,R41,R42	Chip resistor	NM			603	NM
4	4	R26,R37,R49,R54	Chip resistor	0			0805	Std
2	2	R27,R58	Chip resistor	124 k Ω	1%		603	Std
NM	NM	R28,R29,R30,R31R33, R34,R35,R36R70,R71, R100, R120,R121	Chip resistor	NM			603	NM
2	2	R32,R51	Chip resistor	100 k Ω			805	Std
3	3	R38,R65,R117	Chip resistor	4.75 k Ω	1%		603	Std
3	3	R44,R52,R119	Chip resistor	1 k Ω			603	Std
2	2	R45,R99	Chip resistor	47 k Ω			603	Std
1	1	R53	Chip resistor	10 Ω			805	Std
6	6	R60,R64,R68, R84,R87,R98	Chip resistor	0			603	Std
2	2	R62,R80	Chip resistor	10 Ω			603	Std
NM	NM	R66,R81,R97	Chip resistor	NM			603	NM
2	2	R67,R106	Chip resistor	10 k Ω			603	Std
1	1	R72	Chip resistor	124 k Ω	1%		603	Std
1	1	R73	Trimmer resistor	100 k Ω				Vishay
2	2	R83,R107	Chip resistor	100 k Ω			603	Std
1	1	R89	Chip resistor	2.7 k Ω			603	Std
1	1	R90	Chip resistor	3.31 k Ω	1%		603	Std



Table 6. EVALPM8803-FWD BOM (continued)

3.3 V	5 V	Reference	Description	Value	Tol.	Voltage	Body	Vendor
1	1	R91	Chip resistor	10 Ω			603	Std
1	1	R92	Chip resistor	22 Ω			603	Std
1	1	R93	Chip resistor	680 Ω			603	Std
1	1	R94	Chip resistor	21 k Ω	1%		603	Std
1	1	R95	Chip resistor	24.9 k Ω	1%		603	Std
1	1	R96	Chip resistor	0			603	Std
NM	NM	R101	Chip resistor	NM			603	NM
1	1	R102	Chip resistor	35.6	1%		805	Std
1	1	R103	Chip resistor	510 Ω			603	Std
1	NM	R104	Chip resistor	3.31 k Ω	1%		603	Std
NM	1	R104	Chip resistor	4.75 k Ω	1%		603	Std
2	2	R108,R109	Chip resistor	0.30 Ω	1%		1206	Std low value
1	1	R111	Chip resistor	12.4 k Ω	1%		603	Std
NM	1	R112	Chip resistor	15 k Ω	1%		603	Std
17	17	TP1,TP2,TP4,TP5TP6, TP7,TP9, TP10,TP13,TP14,TP15, TP16,TP17,TP18,TP20, TP21,TP22	Test points	Red				Std
7	7	TP3,TP8,TP11, TP12,TP19,TP23,TP24	Test points	Black				Std
2	2	T1,T2	POE+ Magnetics	ETH1-230LD				Coilcraft
NM	NM	T3	CM choke	NM				NM
NM	1	T5	Power transformer	HA3691-AL				Coilcraft
1	NM	T5	Power transformer	JA4173-AL				Coilcraft
NM	NM	T6	Power transformer	(POE300F series)				NM



Table 6. EVALPM8803-FWD BOM (continued)

3.3 V	5 V	Reference	Description	Value	Tol.	Voltage	Body	Vendor
NM	NM	T7	Power transformer	(POE13P series)				NM
1	1	T8	Gate driver transformer	DA2319-AL				Coilcraft
1	1	U1	POE+ controller	PM8803			HTSSOP20	ST
3	3	U2,U3,U7	SMT optocoupler	Fairchild FOD817AS			4PDIP	Fairchild
1	1	U4	Shunt regulator	TS431AILT			SOT23-5	ST
NM	NM	U5	Shunt regulator	(TS2431AILT)			SOT23	NM

6 Power-up sequence

It is recommended to apply power at PoE input first, slowly increasing the voltage to verify the absence of abnormal input current levels.

From about 2 V to about 12 V input, the demonstration kit performs the detection signature. At 10 V input the current drawn is about 400 μ A.

In the range of 14 V to 23 V, the demonstration kit performs a class-4 classification, and the current drawn is about 40 mA.

After those two steps are verified, the voltage can be increased to 48 V typical. The PoE converter starts operations at about 36 V input.

Three green LEDs indicate proper operation of the PoE and DC-DC section of the PM8803 demonstration kit:

- D44 is the T2P LED and is ON when the PM8803 has successfully recognized a type 2 PSE or a 802.3at compliant injector; using a bench power supply to power up the PM8803 demonstration board, this LED is OFF.
- D26 indicates the presence of the output voltage.
- D20 is the AUX LED and indicates the presence of an auxiliary voltage applied to the converter; proper selection of the auxiliary voltage is done with jumper JM1 and JM2: put a short between pin 1 and 2 when SA auxiliary source on J1 connector is used; put the short between pin 2 and 3 when SP auxiliary source on J2 connector is used.

Note: Set the R73 trimmer at a value around 10 k Ω

Adjust this value for best converter performances in terms of efficiency over its actual load range.

Note: In the case of SA external auxiliary source tests, it is strongly recommended to change the position of the 100 nF, 100 V from C18, at the input filter, where it is soldered to C60, across the internal hot-swap MOSFET. This change of position, that has no impact on the standard compliance, permits an optimal behavior of the PM8803 device during the change of ground reference consequent to the power jack insertion/removal.

7 Test results

7.1 Efficiency measurement with 3.3 V output

Figure 10. Efficiency measurements at 48 V input

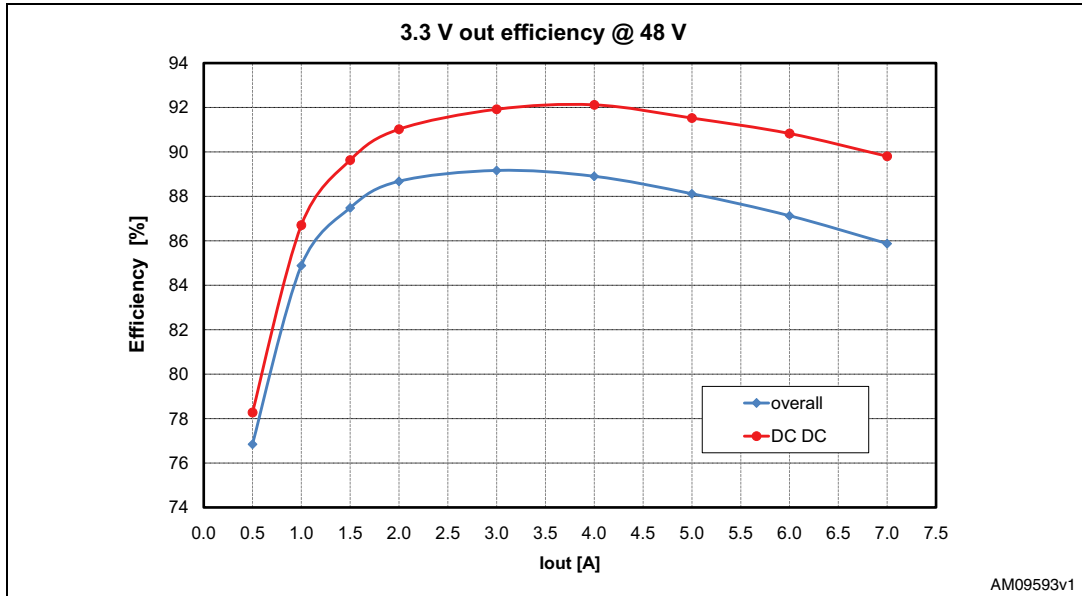

Figure 11. DC-DC only efficiency measurements

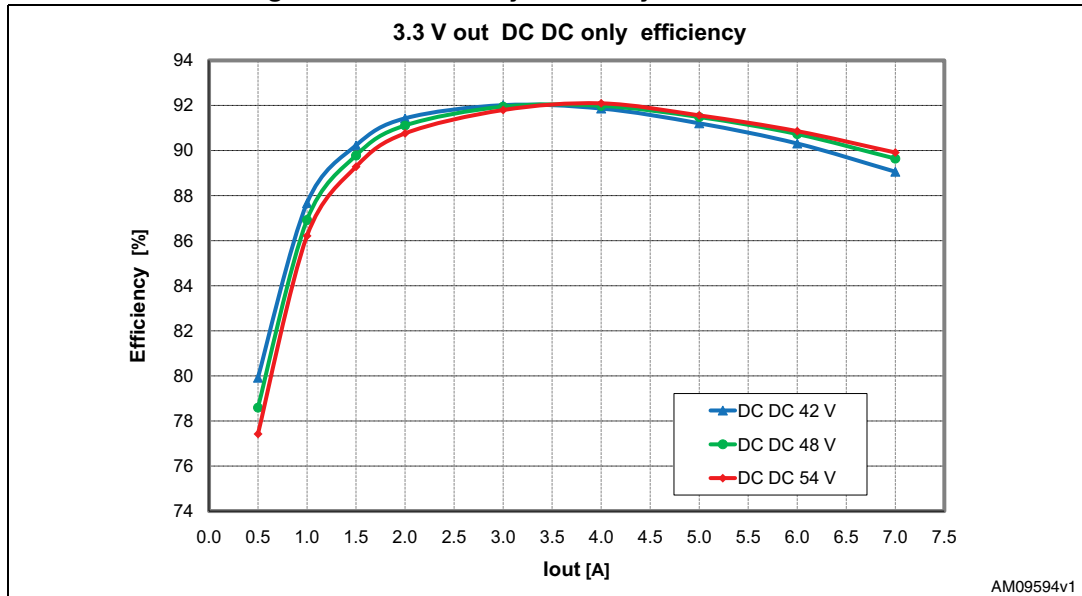
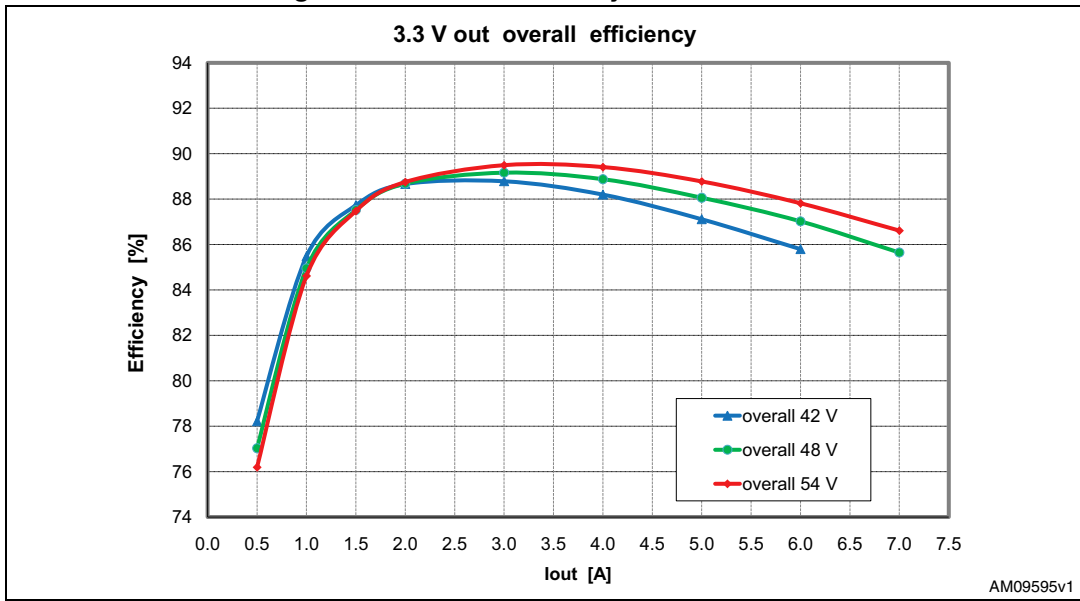

Figure 12. Overall efficiency measurements



7.2 Efficiency measurements with 5 V output

Figure 13. Efficiency measurements at 48 V input

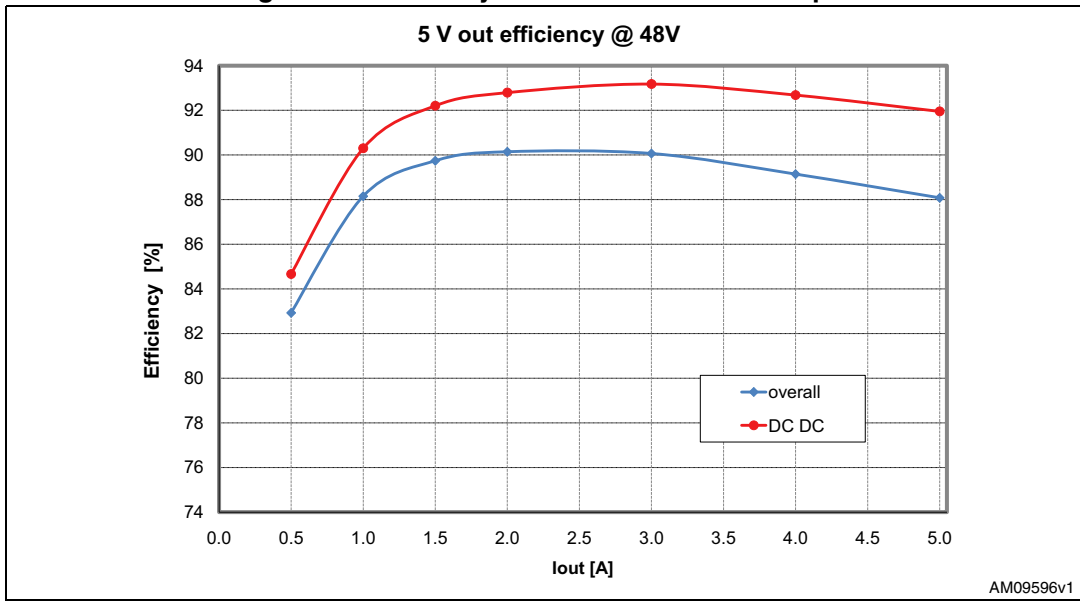

Figure 14. DC-DC only efficiency measurements

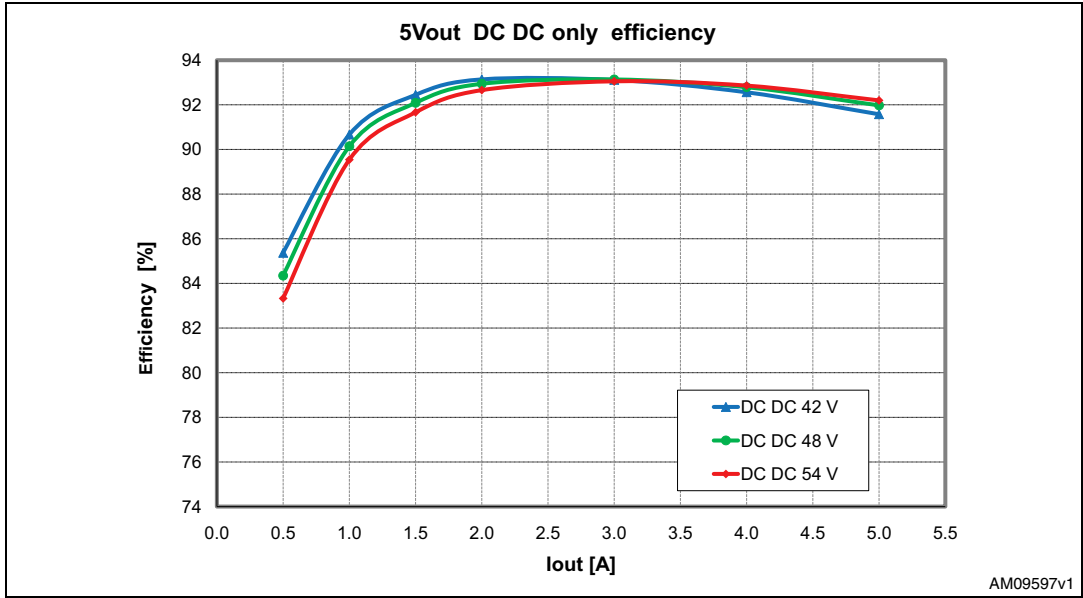
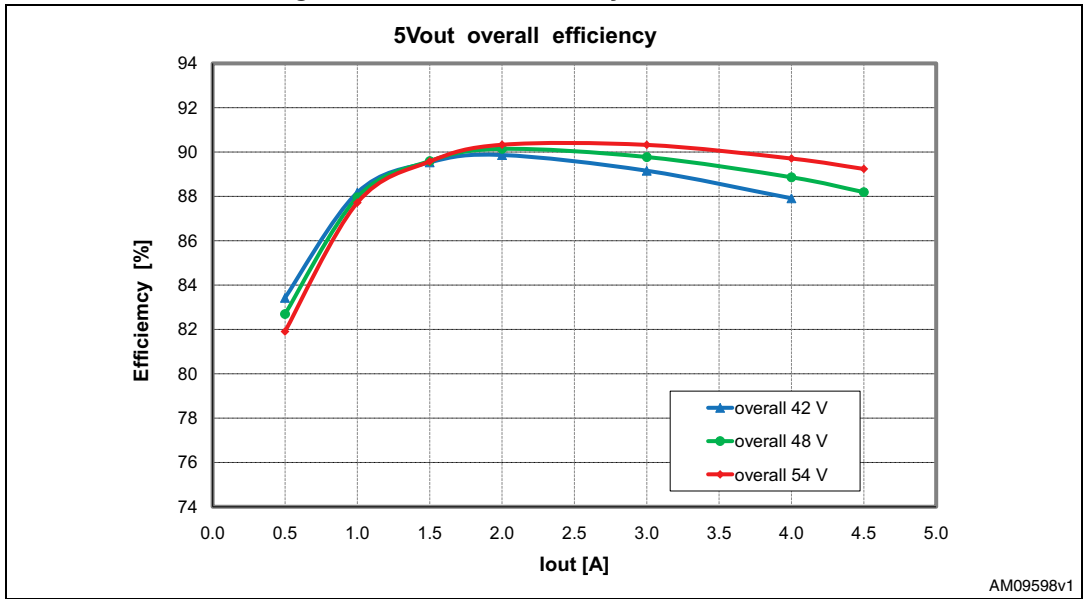

Figure 15. Overall efficiency measurements



7.3 Waveforms

The following images were taken on a 5 V output demonstration board. Similar waveforms are also applicable for the 3.3 V output version.

7.3.1 Startup sequence from PoE/PoE+ injectors

Figure 16. Startup from an IEEE 802.3af injector with 2 A load

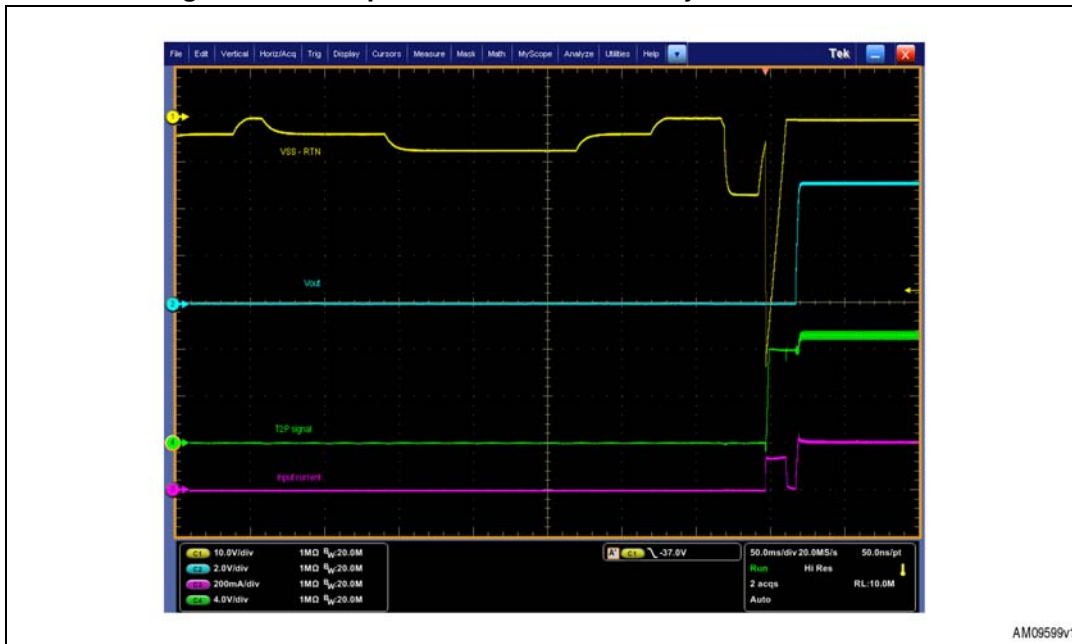

AM09599v1

Note the inrush current limited at about 140 mA and the T2P signal not asserted.

Figure 17. Startup from an IEEE 802.3at injector with 4 A load



AM09600v1

Note, in this case, the presence of the 2-finger during the classification phase and the T2P signal now asserted (T2P is valid low).

7.3.2 Transition from PoE to auxiliary and auxiliary to PoE

Figure 18 shows the behavior of the PM8803 when commuting sources. The image depicts the transition from PoE to an auxiliary source whose voltage is ~10 V lower than PoE. It can be seen that when the auxiliary voltage is applied (SA pin goes above its threshold) the current drawn from the PoE drops to a few milliAmps. Smooth transition occurs as can be seen from the output voltage (blue line).

Figure 18. Switching between PoE and auxiliary source

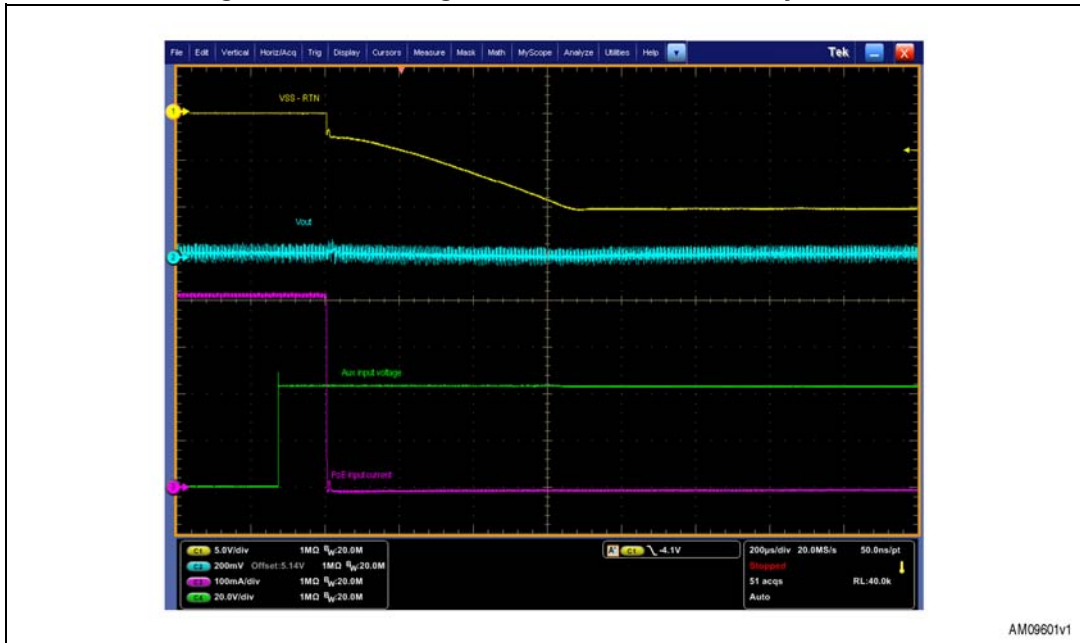

AM09601v1

7.3.3 Primary side MOSFET

Figure 19. Primary side power MOSFET waveforms at 0 A load

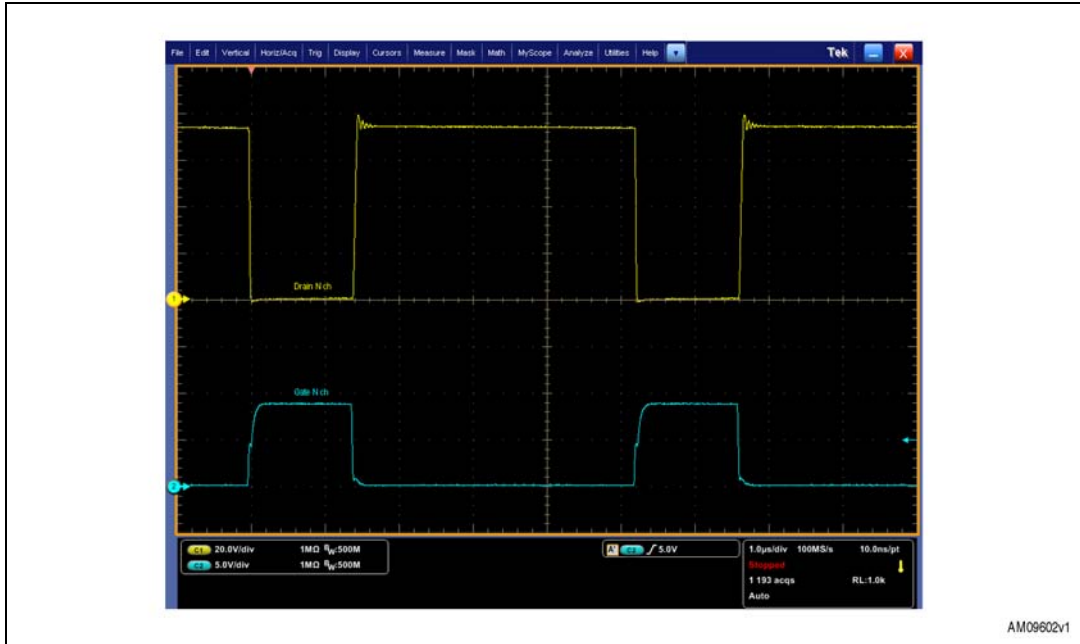
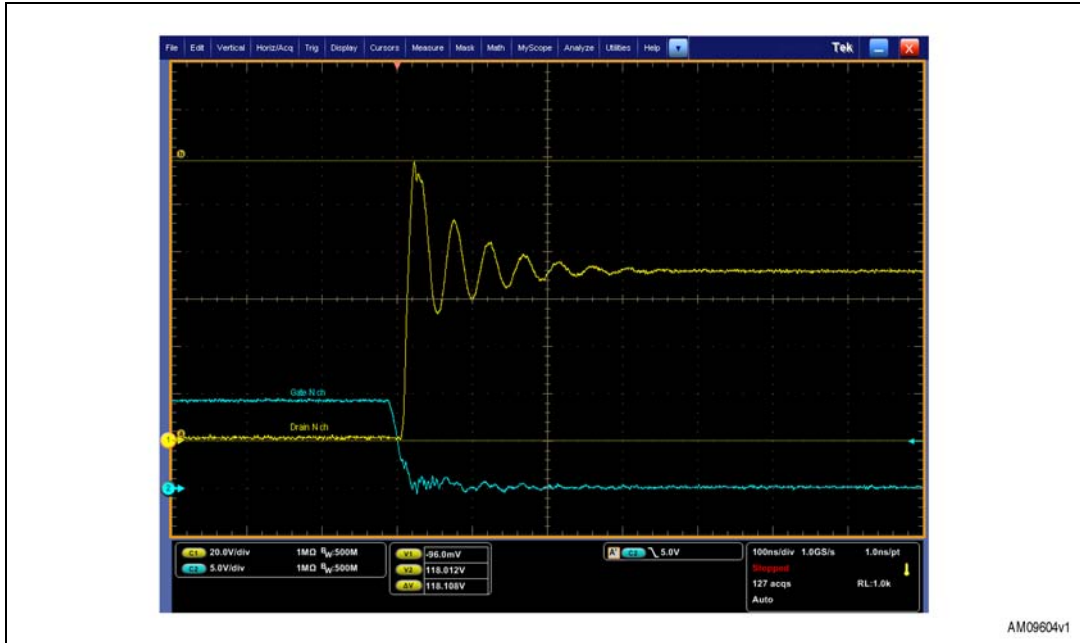

Figure 20. Primary side power MOSFET waveforms at 4 A load



Figure 21. Details of primary side power MOSFET waveforms at 4 A load



7.3.4 Secondary side MOSFET

Figure 22. Secondary side power MOSFET waveforms at 0 A load

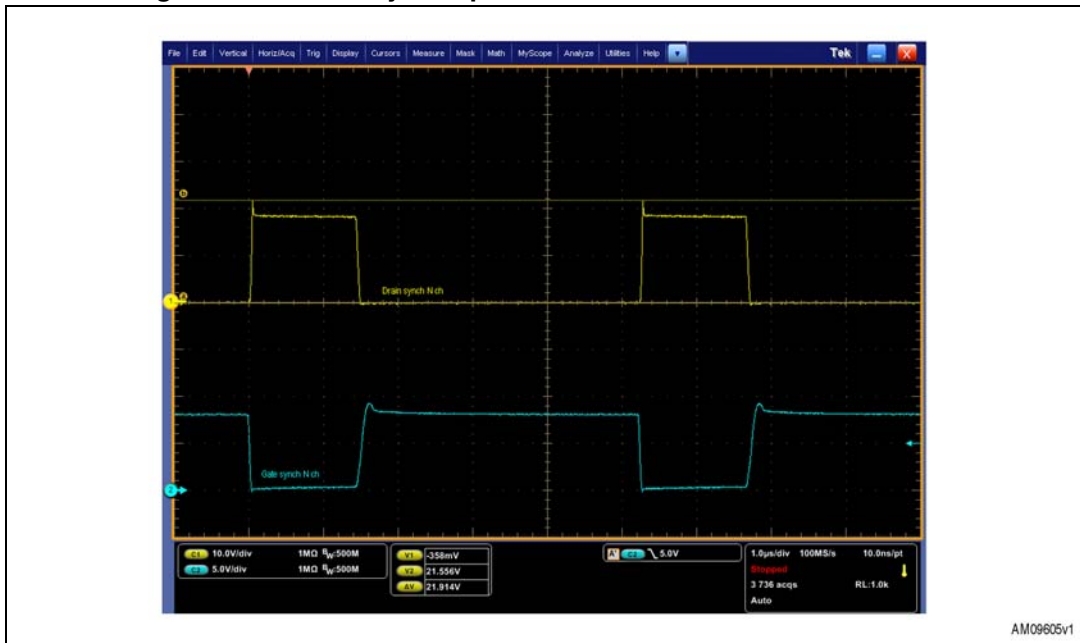
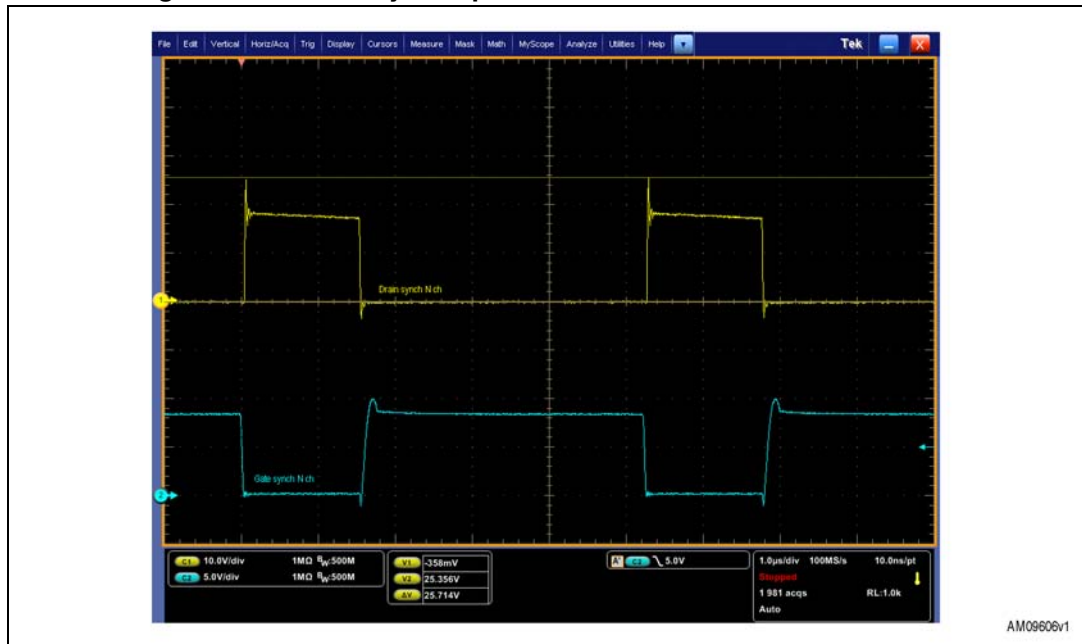

Figure 23. Secondary side power MOSFET waveforms at 4 A load



AM09606v1

7.3.5 Line transient

Figure 24 depicts the effect of a line transient on the PoE converter. A 12 V step on a 42 V input PoE line (green trace) is shown. The hot-swap MOSFET (yellow trace) withstands the transient while the input current (pink trace) is limited during the input capacitor charge; the converter continues to work and the output voltage (blue trace) remains in regulation.

Figure 24. Effect of a 12 V line transient on the converter at 4 A load

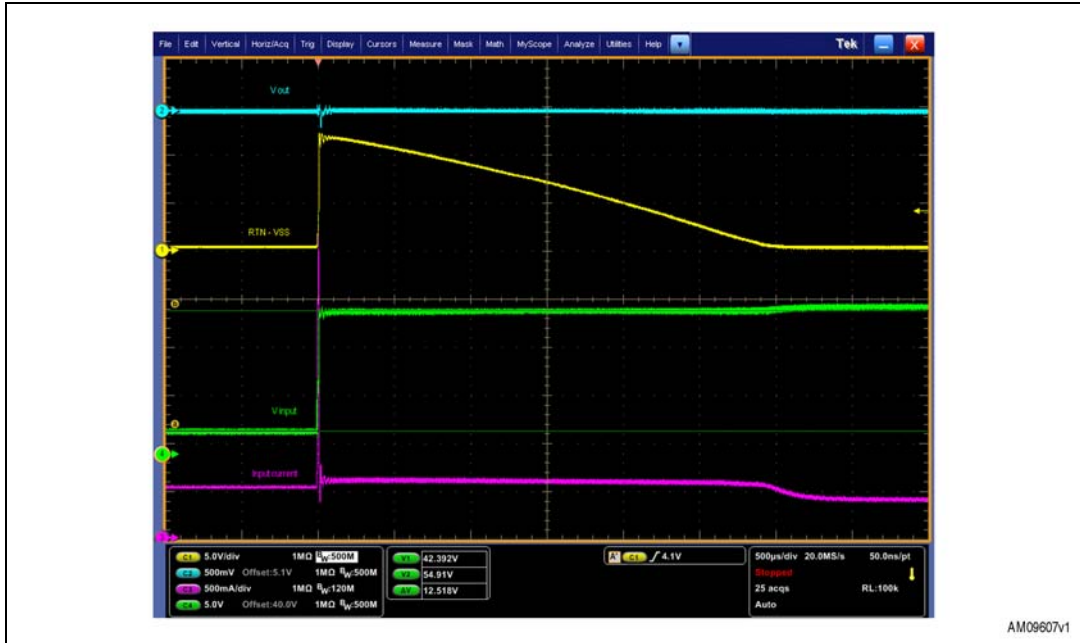
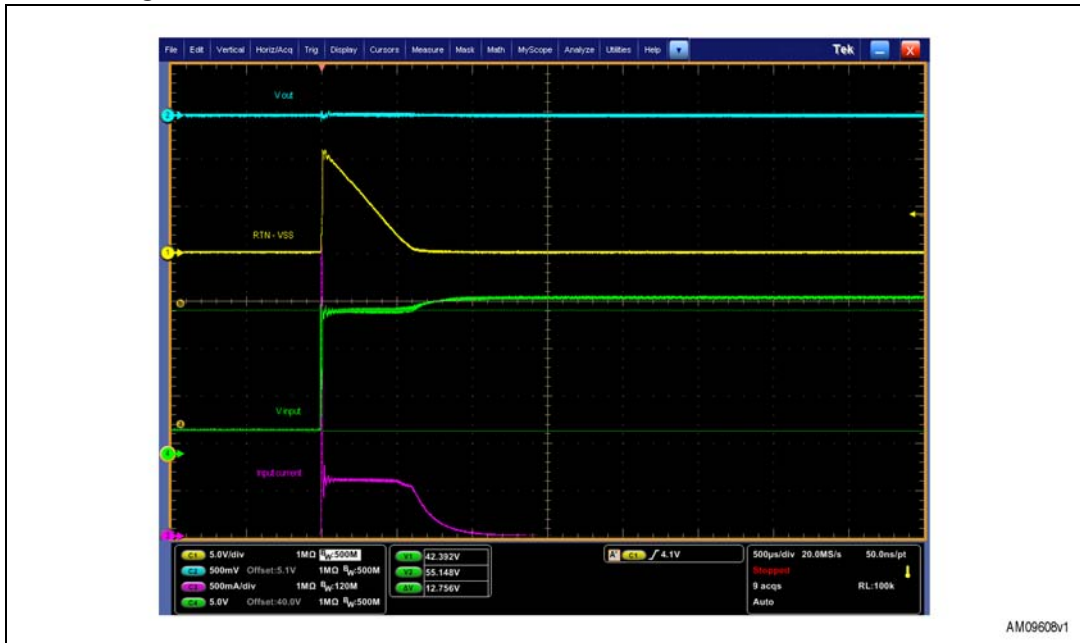

Figure 25. Effect of a 12 V line transient on the converter at 0 A load



7.3.6 Load transient

Figure 26. Response of the converter to a 2 A - 4 A load transient



Figure 27. Response of the converter to a 0 A - 4 A load transient



7.3.7 Output ripple

Figure 28. Output ripple measurement at 4 A

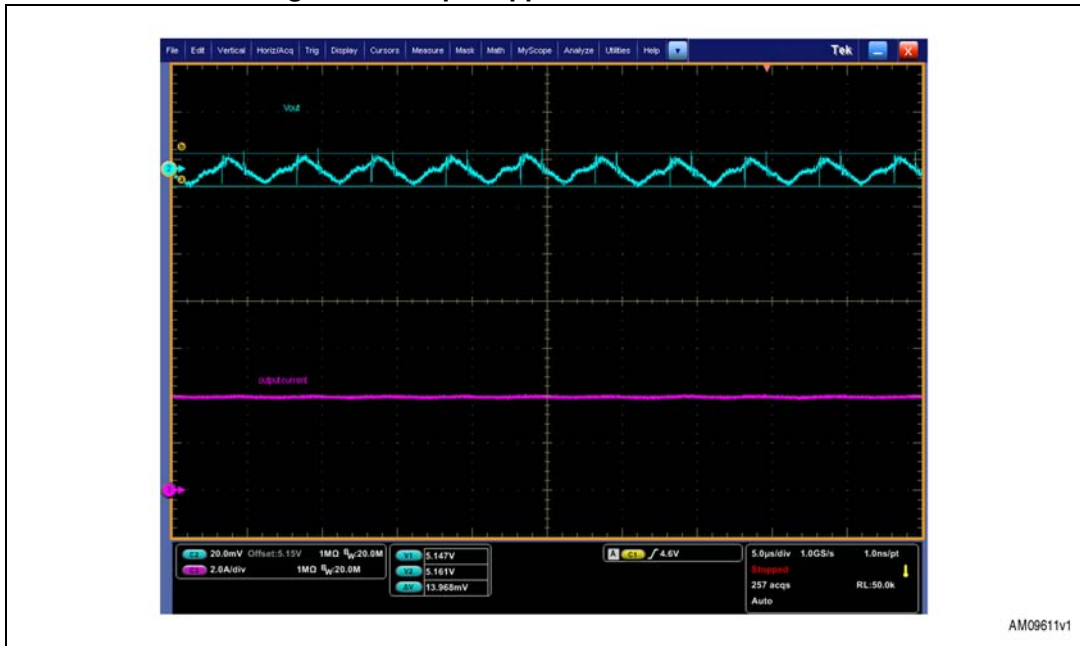

Figure 29. Output ripple measurement at 4 A with infinite persistence



8 Revision history

Table 7. Document revision history

Date	Revision	Changes
23-Mar-2011	1	Initial release.
18-Feb-2013	2	Document title has been changed.

Please Read Carefully:

Information in this document is provided solely in connection with ST products. STMicroelectronics NV and its subsidiaries ("ST") reserve the right to make changes, corrections, modifications or improvements, to this document, and the products and services described herein at any time, without notice.

All ST products are sold pursuant to ST's terms and conditions of sale.

Purchasers are solely responsible for the choice, selection and use of the ST products and services described herein, and ST assumes no liability whatsoever relating to the choice, selection or use of the ST products and services described herein.

No license, express or implied, by estoppel or otherwise, to any intellectual property rights is granted under this document. If any part of this document refers to any third party products or services it shall not be deemed a license grant by ST for the use of such third party products or services, or any intellectual property contained therein or considered as a warranty covering the use in any manner whatsoever of such third party products or services or any intellectual property contained therein.

UNLESS OTHERWISE SET FORTH IN ST'S TERMS AND CONDITIONS OF SALE ST DISCLAIMS ANY EXPRESS OR IMPLIED WARRANTY WITH RESPECT TO THE USE AND/OR SALE OF ST PRODUCTS INCLUDING WITHOUT LIMITATION IMPLIED WARRANTIES OF MERCHANTABILITY, FITNESS FOR A PARTICULAR PURPOSE (AND THEIR EQUIVALENTS UNDER THE LAWS OF ANY JURISDICTION), OR INFRINGEMENT OF ANY PATENT, COPYRIGHT OR OTHER INTELLECTUAL PROPERTY RIGHT.

ST PRODUCTS ARE NOT AUTHORIZED FOR USE IN WEAPONS. NOR ARE ST PRODUCTS DESIGNED OR AUTHORIZED FOR USE IN: (A) SAFETY CRITICAL APPLICATIONS SUCH AS LIFE SUPPORTING, ACTIVE IMPLANTED DEVICES OR SYSTEMS WITH PRODUCT FUNCTIONAL SAFETY REQUIREMENTS; (B) AERONAUTIC APPLICATIONS; (C) AUTOMOTIVE APPLICATIONS OR ENVIRONMENTS, AND/OR (D) AEROSPACE APPLICATIONS OR ENVIRONMENTS. WHERE ST PRODUCTS ARE NOT DESIGNED FOR SUCH USE, THE PURCHASER SHALL USE PRODUCTS AT PURCHASER'S SOLE RISK, EVEN IF ST HAS BEEN INFORMED IN WRITING OF SUCH USAGE, UNLESS A PRODUCT IS EXPRESSLY DESIGNATED BY ST AS BEING INTENDED FOR "AUTOMOTIVE, AUTOMOTIVE SAFETY OR MEDICAL" INDUSTRY DOMAINS ACCORDING TO ST PRODUCT DESIGN SPECIFICATIONS. PRODUCTS FORMALLY ESCC, QML OR JAN QUALIFIED ARE DEEMED SUITABLE FOR USE IN AEROSPACE BY THE CORRESPONDING GOVERNMENTAL AGENCY.

Resale of ST products with provisions different from the statements and/or technical features set forth in this document shall immediately void any warranty granted by ST for the ST product or service described herein and shall not create or extend in any manner whatsoever, any liability of ST.

ST and the ST logo are trademarks or registered trademarks of ST in various countries.

Information in this document supersedes and replaces all information previously supplied.

The ST logo is a registered trademark of STMicroelectronics. All other names are the property of their respective owners.

© 2013 STMicroelectronics - All rights reserved

STMicroelectronics group of companies

Australia - Belgium - Brazil - Canada - China - Czech Republic - Finland - France - Germany - Hong Kong - India - Israel - Italy - Japan - Malaysia - Malta - Morocco - Philippines - Singapore - Spain - Sweden - Switzerland - United Kingdom - United States of America

www.st.com