

AH2

High Dynamic Range Amplifier



Product Features

- 50 – 1000 MHz
- +40 dBm OIP3
- -71dBc CTB
- -48dBc CSO
- 3.5 dB Noise Figure
- 14.5 dB Gain
- +20 dBm P1dB
- Lead-free/Green/RoHS-compliant SOT-89 Package
- Single +5 V Supply
- MTTF > 100 years

Product Description

The AH2 is a general purpose, high dynamic range amplifier targeting cable TV markets. The combination of gain flatness, high linearity and bandwidth make it ideal for CATV distribution, cable modem and laser diode driver applications. The AH2 is designed for 75 ohm systems and can operate directly from a +5 Volt DC regulator. The device is manufactured using reliable GaAs MESFET technology and boasts an MTBF of >100 years at a mounting temperature of +85 °C. It is available in the environmentally-friendly lead-free/green/RoHS-compliant SOT-89 package. All devices are 100% RF and DC tested.

Functional Diagram

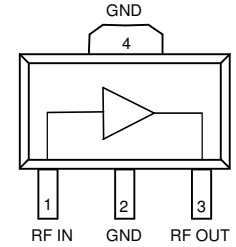

| Function | Pin No. |
|-------------|---------|
| Input | 1 |
| Output/Bias | 3 |
| Ground | 2, 4 |

Applications

- CATV / DBS

Specifications ⁽¹⁾

| Parameter | Units | Min | Typ | Max |
|---------------------------|-------|-----|------|------|
| Operational Bandwidth | MHz | 50 | | 1000 |
| Test Frequency | MHz | | 800 | |
| Gain | dB | 13 | 14.5 | |
| Input Return Loss | dB | | 14 | |
| Output Return Loss | dB | | 17 | |
| Output P1dB | dBm | | +21 | |
| Output IP3 ⁽²⁾ | dBm | +37 | +40 | |
| Noise Figure | dB | | 3.5 | |
| Operating Current Range | mA | 120 | 150 | 180 |
| Supply Voltage | V | | 5 | |

1. Test conditions unless otherwise noted: T = 25 °C, 50 Ω system.
 2. 3OIP measured with two tones at an output power of +5 dBm/tone separated by 10 MHz. The suppression on the largest IM3 product is used to calculate the 3OIP using a 2:1 rule.

Typical Performance ⁽³⁾

| Parameter | Units | Typical | |
|---------------------------|-------|---------|------|
| Frequency | MHz | 100 | 860 |
| S21 | dB | 14.5 | 13.2 |
| S11 | dB | -14 | -14 |
| S22 | dB | -17 | -17 |
| Output P1dB | dBm | +20 | +20 |
| Output IP3 ⁽²⁾ | dBm | +40 | +40 |
| Output IP2 ⁽²⁾ | dBm | +52 | +52 |
| CTB ⁽⁴⁾ | dBc | -71 | |
| CSO ⁽⁴⁾ | dBc | -48 | |
| Xmod ⁽⁴⁾ | dBc | -65 | |
| Noise Figure | dB | 3.5 | 3.5 |
| Supply Voltage | V | 5 | |
| Device Current | mA | 150 | |

3. Parameters reflect performance in a single-ended 75 ohm circuit, as shown on page 3.
 4. 77 channels 50 – 550MHz +34dBmV/channel, flat-loading

Absolute Maximum Rating

| Parameter | Rating |
|-----------------------------|----------------|
| Operating Case Temperature | -40 to +85 °C |
| Storage Temperature | -55 to +150 °C |
| Supply Voltage | +6 V |
| RF Input Power (continuous) | +10 dBm |
| Junction Temperature | +220 °C |

Operation of this device above any of these parameters may cause permanent damage.

Ordering Information

| Part No. | Description |
|----------|---|
| AH2-G | High Dynamic Range Amplifier (lead-free/green/RoHS-compliant SOT-89 package) |
| AH2-PCB | Single-ended 75 ohm Application Circuit Board |

Typical Device Data

S-Parameters ($V_{DS} = +5\text{ V}$, $I_{DS} = 150\text{ mA}$, $T = 25\text{ }^\circ\text{C}$, unmatched device in a 75 ohm system)

S-Parameters ($V_D = +5\text{ V}$, $I_D = 150\text{ mA}$, $T = 25\text{ }^\circ\text{C}$, calibrated to device leads in a 75 ohm system)

| Freq (MHz) | S11 (dB) | S11 (ang) | S21 (dB) | S21 (ang) | S12 (dB) | S12 (ang) | S22 (dB) | S22 (ang) |
|------------|----------|-----------|----------|-----------|----------|-----------|----------|-----------|
| 50 | -17.85 | -34.21 | 14.88 | 172.97 | -24.58 | 4.81 | -20.87 | -149.34 |
| 100 | -18.10 | -38.37 | 14.92 | 171.11 | -24.56 | 2.30 | -21.20 | -158.61 |
| 150 | -17.37 | -47.65 | 14.89 | 168.59 | -24.55 | 1.69 | -21.20 | -160.06 |
| 200 | -16.63 | -55.66 | 14.74 | 165.97 | -24.53 | 1.17 | -20.82 | -159.44 |
| 250 | -15.73 | -62.92 | 14.86 | 162.85 | -24.48 | 0.72 | -20.50 | -156.95 |
| 300 | -14.91 | -70.31 | 14.61 | 160.05 | -24.45 | 0.58 | -20.36 | -155.78 |
| 350 | -14.20 | -76.37 | 14.64 | 157.30 | -24.42 | 0.44 | -19.77 | -155.09 |
| 400 | -13.45 | -81.85 | 14.62 | 154.45 | -24.34 | 0.16 | -19.23 | -152.65 |
| 450 | -12.80 | -86.94 | 14.60 | 151.27 | -24.31 | -0.28 | -19.02 | -152.33 |
| 500 | -12.18 | -91.91 | 14.53 | 148.33 | -24.32 | -0.47 | -18.49 | -151.93 |
| 550 | -11.53 | -95.72 | 14.34 | 146.02 | -24.21 | -0.94 | -17.96 | -149.07 |
| 600 | -11.04 | -99.60 | 14.26 | 143.33 | -24.18 | -1.00 | -17.84 | -148.36 |
| 650 | -10.51 | -103.27 | 14.19 | 140.39 | -24.12 | -1.10 | -17.56 | -149.69 |
| 700 | -10.02 | -106.94 | 14.10 | 137.75 | -24.11 | -1.54 | -16.97 | -149.32 |
| 750 | -9.64 | -110.30 | 14.02 | 134.99 | -24.02 | -2.04 | -16.69 | -148.96 |
| 800 | -9.22 | -113.34 | 13.96 | 132.29 | -23.93 | -2.63 | -16.42 | -148.88 |
| 850 | -8.81 | -116.55 | 13.83 | 129.84 | -23.89 | -3.12 | -16.13 | -149.30 |
| 900 | -8.48 | -119.17 | 13.69 | 127.70 | -23.85 | -3.33 | -15.87 | -149.09 |
| 950 | -8.11 | -121.84 | 13.54 | 125.28 | -23.81 | -4.08 | -15.59 | -149.60 |
| 1000 | -7.81 | -124.91 | 13.44 | 122.82 | -23.77 | -4.42 | -15.42 | -150.68 |

Device S-parameters are available for download off of the website at: <http://www.wj.com>

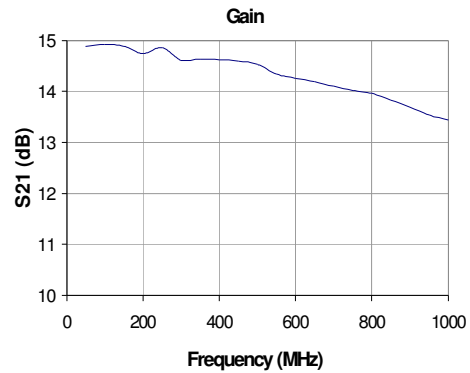
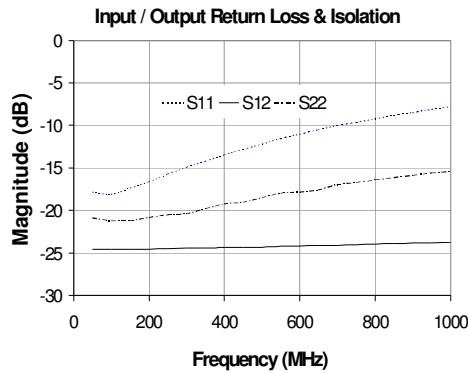

Single – Ended CATV 75 Ω Evaluation Circuit: 50 – 860 MHz (AH2-PCB)

Typical RF Performance at 25 °C

| Frequency | MHz | 100 | 450 | 860 |
|---|-----|-------------|-------|-------|
| S21 – Gain | dB | 14.5 | 14.5 | 13.2 |
| S11 – Input R.L. | dB | -11.1 | -12.7 | -18.3 |
| S22 – Output R.L. | dB | -9.5 | -22.9 | -10.6 |
| Output IP2 (+5 dBm) | dBm | 52.7 | 53.5 | 52.5 |
| Output IP3 (+5 dBm / tone, 10 MHz spacing) | dBm | 39.8 | 40.7 | 40.8 |
| Noise Figure | dB | 3.9 | 3.1 | 3.2 |
| Device Bias | | +5V @ 150mA | | |
| CTB | dBc | -71 | | |
| CSO | dBc | -48 | | |
| XMOD | dBc | -65 | | |

77 channels, 50-550MHz, +34dBmV/channel flat loading

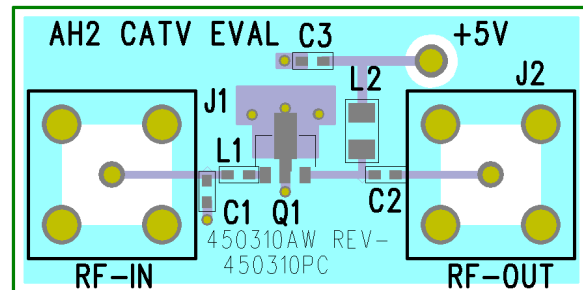
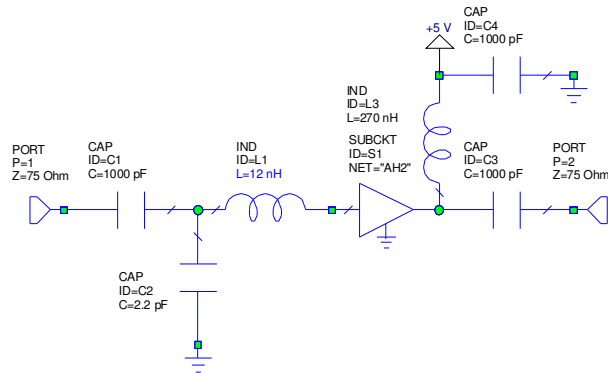

Circuit Board Material: .062" total thickness with a .028" FR-4 top RF layer, 4 layers (other layers added for rigidity), 1 oz copper, 75Ω Microstrip.

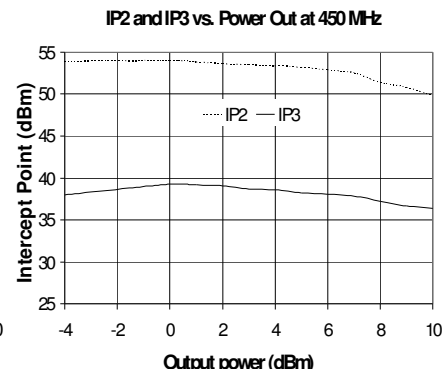
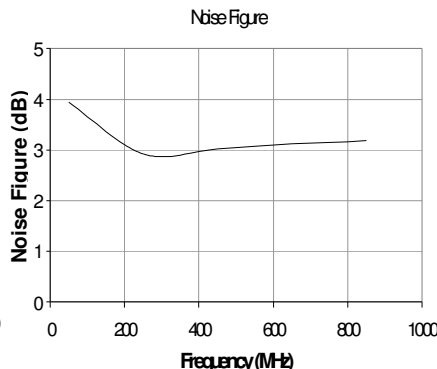
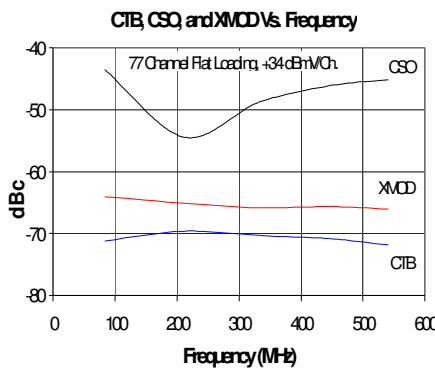
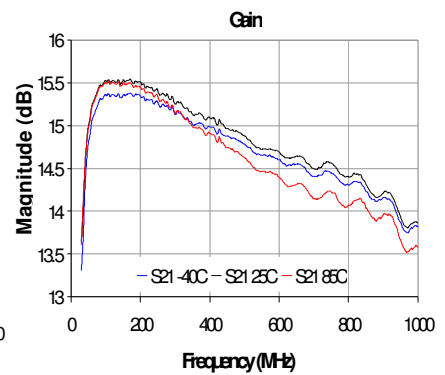
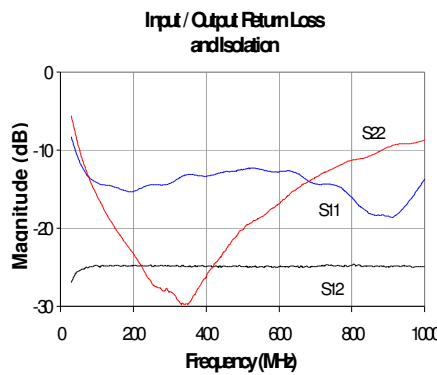
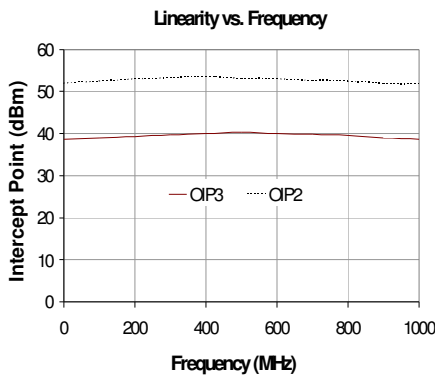

Push-Pull, 75 Ω CATV Reference Design: 50 – 860 MHz

Bias V_{dd} = 5 V, I_d = 300mA

| Frequency | MHz | 100 | 450 | 750 | 860 |
|--------------|-----|-------|-------|-------|-------|
| S21 | dB | 11.1 | 10.8 | 10.6 | 10.5 |
| S11 | dB | -10.2 | -9.7 | -10.8 | -11 |
| S22 | dB | -13.3 | -14.1 | -15.4 | -16.4 |
| Output IP2 | dBm | 72 | 70 | 72 | 70 |
| Output IP3 | dBm | 42 | 43 | 41 | 40 |
| Noise Figure | dB | 5.5 | 4.3 | 5.0 | 5.4 |
| CTB | dBc | -72 | | | |
| CSO | dBc | -75 | | | |
| XMOD | dBc | -68 | | | |

77 channels, 50-550MHz, +34dBmV/channel flat loading

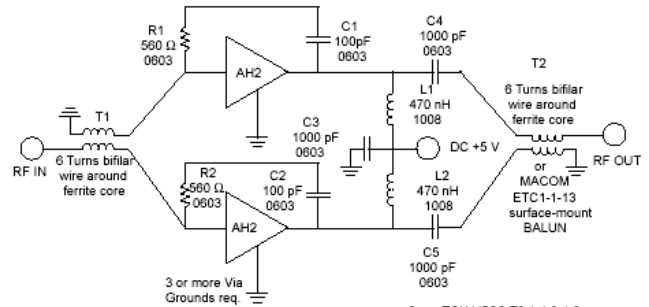
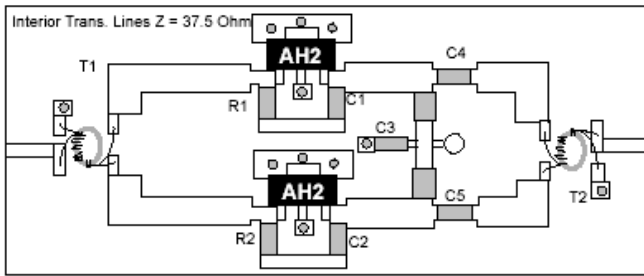

Core: TOK H5C2-T3-1-1.3-1.3
Wire: MWS B2383211

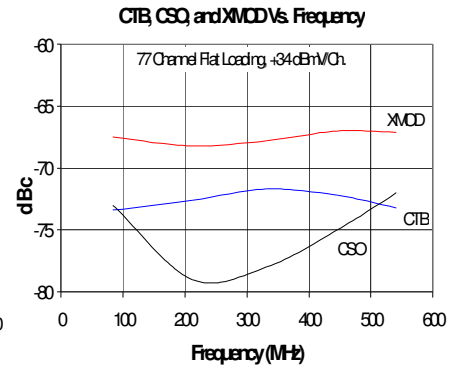
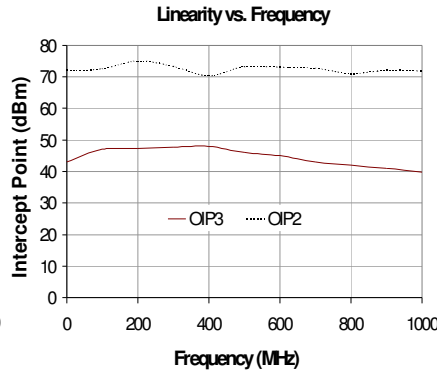
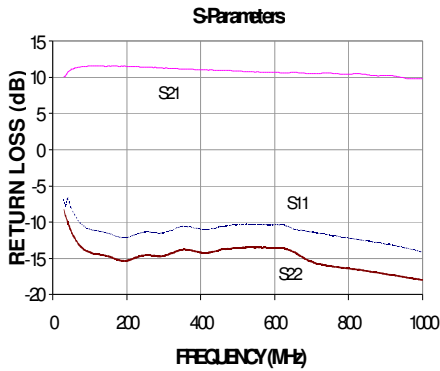

AH2-G (Green / Lead-free SOT-89 Package) Mechanical Information

This package is lead-free/Green/RoHS-compliant. It is compatible with both lead-free (maximum 260 °C reflow temperature) and leaded (maximum 245 °C reflow temperature) soldering processes. The plating material on the leads is NiPdAu.

Outline Drawing

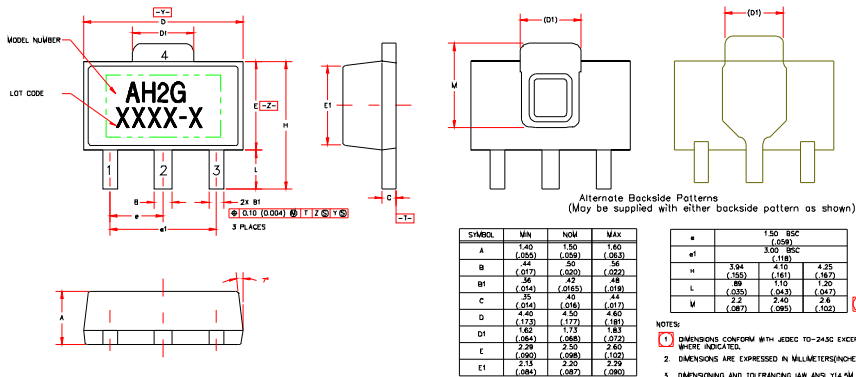

Product Marking

The AH2-G will be marked with an "AH2G" designator. An alphanumeric lot code ("XXXX-X") is also marked below the part designator on the top surface of the package. The obsolete tin-lead package is marked with an "AH2" designator followed by an alphanumeric lot code.

Tape and reel specifications for this part are located on the website in the "Application Notes" section.

Land Pattern

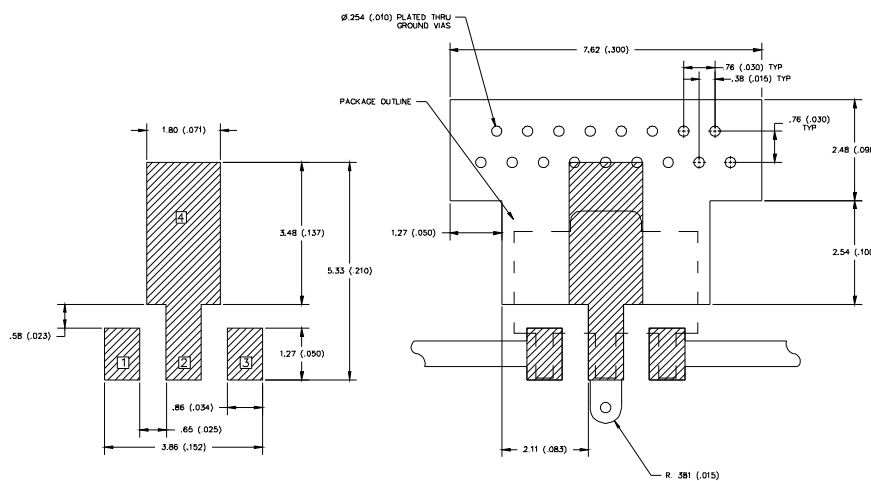

MSL / ESD Rating



Caution! ESD sensitive device.

ESD Rating: Class 1B
 Value: Passes $\geq 500V$ to $<1000V$
 Test: Human Body Model (HBM)
 Standard: JEDEC Standard JESD22-A114

ESD Rating: Class IV
 Value: Passes $\geq 1000V$ to $<2000V$
 Test: Charged Device Model (CDM)
 Standard: JEDEC Standard JESD22-C101

MSL Rating: Level 1 at +260 °C convection reflow
 Standard: JEDEC Standard J-STD-020

Thermal Specifications

| Parameter | Rating |
|------------------------------------|---------------|
| Operating Case Temperature | -40 to +85 °C |
| Thermal Resistance, $R_{th}^{(1)}$ | 59 °C / W |
| Junction Temperature, $T_j^{(2)}$ | 129 °C |

- The thermal resistance is referenced from the hottest part of the junction to the ground tab (pin 4).
- This corresponds to the typical biasing condition of +5V, 150 mA at an 85 °C case temperature. A minimum MTTF of 1 million hours is achieved for junction temperatures below 160 °C.

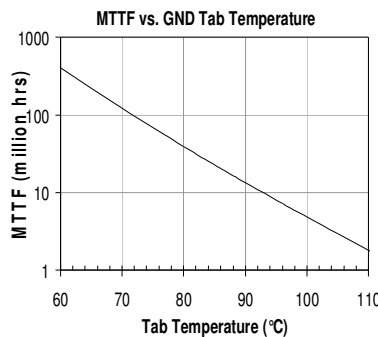

Mounting Config. Notes

- Ground / thermal vias are critical for the proper performance of this device. Vias should use a .35mm (#80 / .0135") diameter drill and have a final plated thru diameter of .25mm (.010").
- Add as much copper as possible to inner and outer layers near the part to ensure optimal thermal performance.
- Mounting screws can be added near the part to fasten the board to a heatsink. Ensure that the ground / thermal via region contacts the heatsink.
- Do not put solder mask on the backside of the PC board in the region where the board contacts the heatsink.
- RF trace width depends upon the PC board material and construction.
- Use 1 oz. Copper minimum.
- All dimensions are in millimeters (inches). Angles are in degrees.