

# MA3075WALT1

Preferred Device

## Zener Transient Voltage Suppressor

### SOT-23 Dual Common Anode Zeners for ESD Protection

These dual monolithic silicon zener diodes are designed for applications requiring transient overvoltage protection capability. They are intended for use in voltage and ESD sensitive equipment such as computers, printers, business machines, communication systems, medical equipment and other applications. Their dual junction common anode design protects two separate lines using only one package. These devices are ideal for situations where board space is at a premium.

#### Features

- SOT-23 Package Allows Two Separate Unidirectional Configurations
- Low Leakage < 1  $\mu$ A @ 5.0 V
- Breakdown Voltage: 7.2–7.9 V @ 5 mA
- Low Capacitance (80 pF typical @ 0 V, 1 MHz)
- ESD Protection Meeting: 16 kV Human Body Model  
30 kV Air and Contact Discharge
- Pb-Free Packages are Available

#### Mechanical Characteristics:

- Void Free, Transfer-Molded, Thermosetting Plastic Case
- Corrosion Resistant Finish, Easily Solderable
- Package Designed for Optimal Automated Board Assembly
- Small Package Size for High Density Applications

#### MAXIMUM RATINGS

| Rating  | Symbol          | Value          | Unit        |
|---|-----------------|----------------|-------------|
| Peak Power Dissipation @ 100 $\mu$ s (Note 1)   | $P_{pk}$        | 15             | W           |
| Steady State Power Dissipation<br>Derate above 25°C (Note 2)  | $P_D$           | 225<br>1.8     | mW<br>mW/°C |
| Thermal Resistance, Junction-to-Ambient   | $R_{\theta JA}$ | 556            | °C/W        |
| Maximum Junction Temperature  | $R_{\theta JA}$ | 417            | °C/W        |
| Operating Junction and Storage<br>Temperature Range   | $T_J, T_{stg}$  | -55 to +150    | °C          |
| ESD Discharge<br>MIL STD 883C – Method 3015-6<br>IEC61000-4-2, Air Discharge<br>IEC61000-4-2, Contact Discharge | $V_{PP}$        | 16<br>30<br>30 | kV          |

Maximum ratings are those values beyond which device damage can occur. Maximum ratings applied to the device are individual stress limit values (not normal operating conditions) and are not valid simultaneously. If these limits are exceeded, device functional operation is not implied, damage may occur and reliability may be affected.

1. Non-repetitive 100  $\mu$ s pulse width
2. Mounted on FR-5 Board = 1.0 X 0.75 X 0.062 in.



ON Semiconductor®

<http://onsemi.com>

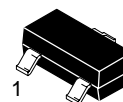
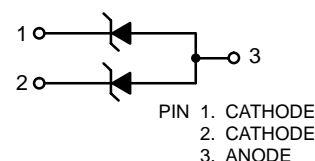

SOT-23  
CASE 318  
STYLE 12

#### MARKING DIAGRAM

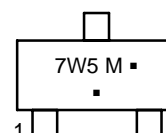

7W5 = Specific Device Code  
M = Date Code\*  
▪ = Pb-Free Package

(Note: Microdot may be in either location)

\*Date Code orientation and/or overbar may vary depending upon manufacturing location.

#### ORDERING INFORMATION

| Device       | Package             | Shipping†        |
|--------------|---------------------|------------------|
| MA3075WALT1  | SOT-23              | 3000/Tape & Reel |
| MA3075WALT1G | SOT-23<br>(Pb-Free) | 3000/Tape & Reel |

†For information on tape and reel specifications, including part orientation and tape sizes, please refer to our Tape and Reel Packaging Specifications Brochure, BRD8011/D.

Preferred devices are recommended choices for future use and best overall value.

# MA3075WALT1

## ELECTRICAL CHARACTERISTICS

| Parameter  | Symbol   | Conditions             | Min | Typ | Max | Unit                       |
|--|----------|------------------------|-----|-----|-----|----------------------------|
| Forward Voltage  | $V_F$    | $I_F = 10 \text{ mA}$  |     | 0.8 | 0.9 | V                          |
| Zener Voltage <sup>*2</sup>                            | $V_Z$    | $I_Z = 5 \text{ mA}$   | 7.2 | 7.5 | 7.9 | V                          |
| Operating Resistance                                   | $R_{ZK}$ | $I_Z = 0.5 \text{ mA}$ |     |     | 120 | $\Omega$                   |
|  | $R_Z$    | $I_Z = 5 \text{ mA}$   |     | 6   | 15  | $\Omega$                   |
| Reverse Current  | $I_{R1}$ | $V_R = 5 \text{ V}$    |     |     | 1   | $\mu\text{A}$              |
|  | $I_{R2}$ | $V_R = 6.5 \text{ V}$  |     |     | 60  | $\mu\text{A}$              |
| Temperature Coefficient of Zener Voltage <sup>*3</sup> | $S_Z$    | $I_Z = 5 \text{ mA}$   | 2.5 | 4.0 | 5.3 | $\text{mV}/^\circ\text{C}$ |
| Terminal Capacitance                                   | $C_t$    | $V_R = 0 \text{ V}$    |     | 80  |     | $\text{pF}$                |

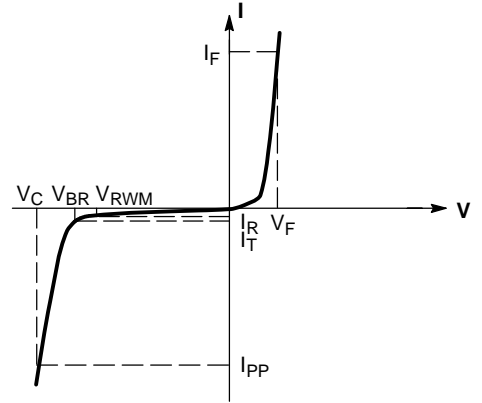

Uni-Directional TVS

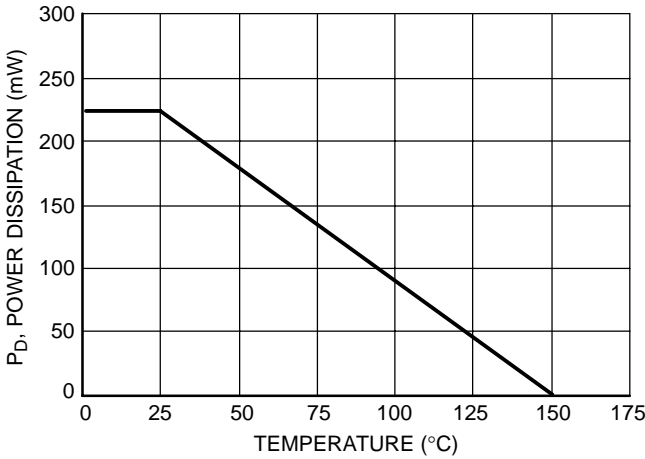

Figure 1. Steady State Power Derating Curve

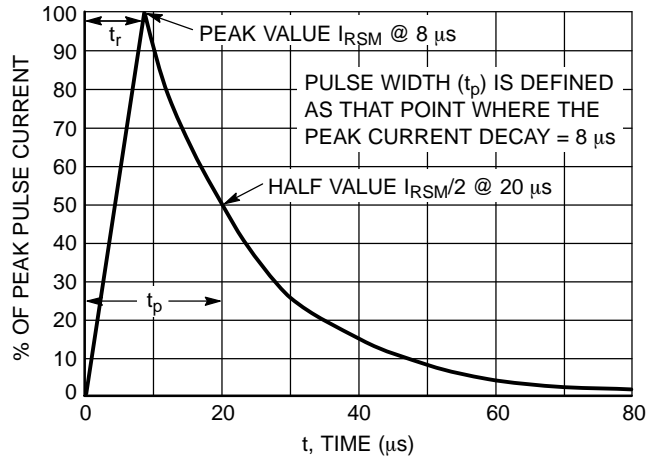

Figure 2. 8 X 20  $\mu\text{s}$  Pulse Waveform

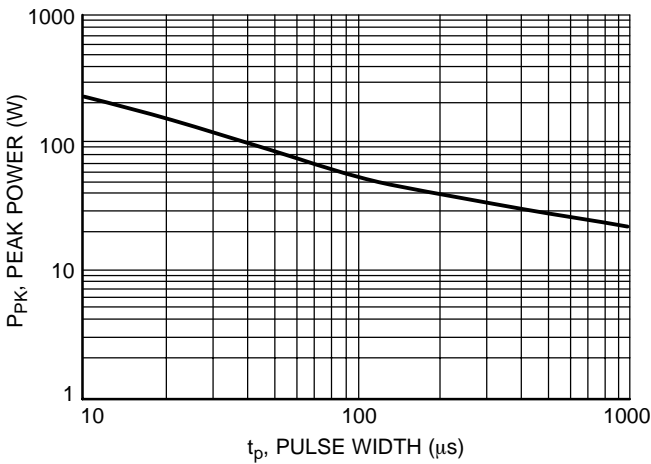

Figure 3. Pulse Rating Curve

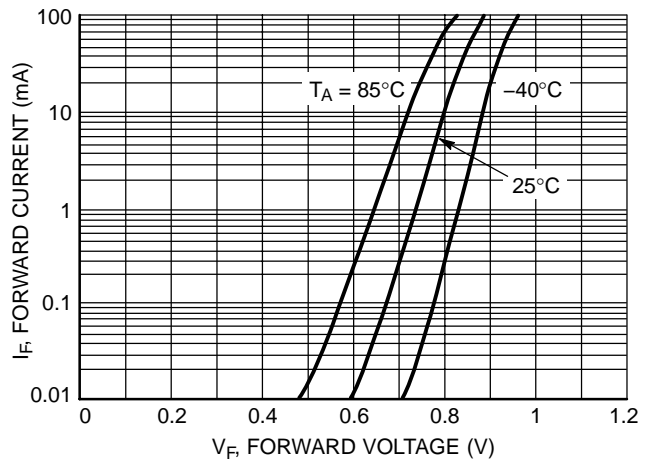

Figure 4. Forward Current versus Forward Voltage

# MA3075WALT1

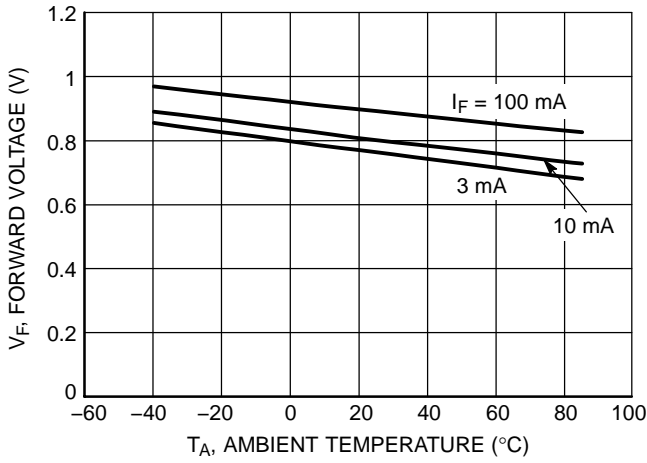

Figure 5. Forward Voltage versus Temperature

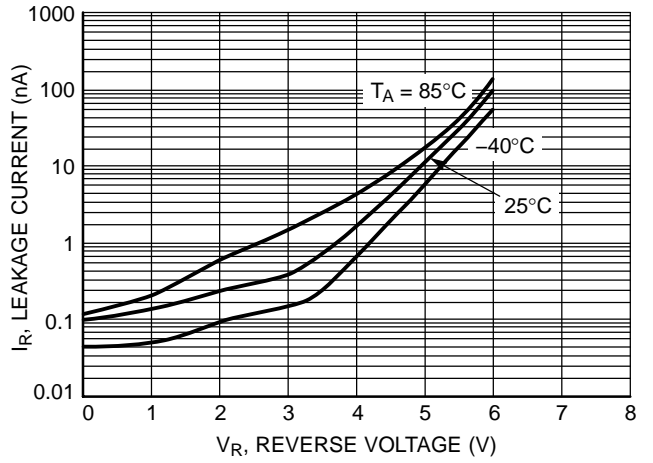

Figure 6. Leakage Current versus Reverse Voltage

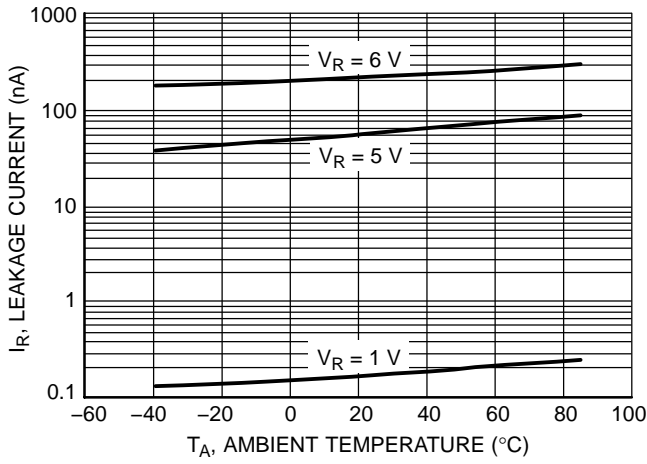

Figure 7. Leakage Current versus Temperature

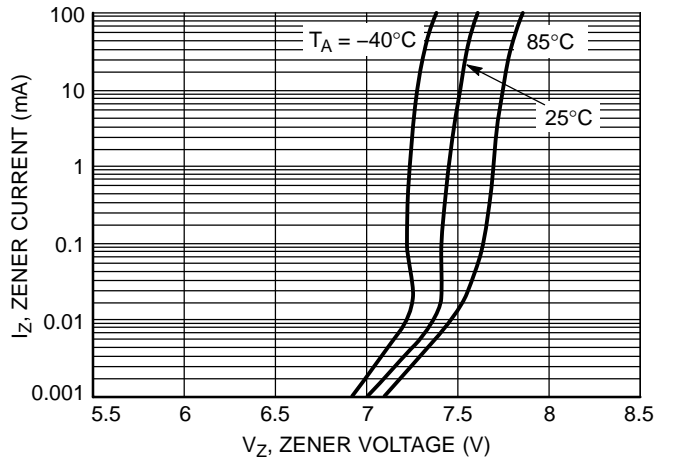

Figure 8. Zener Current versus Zener Voltage

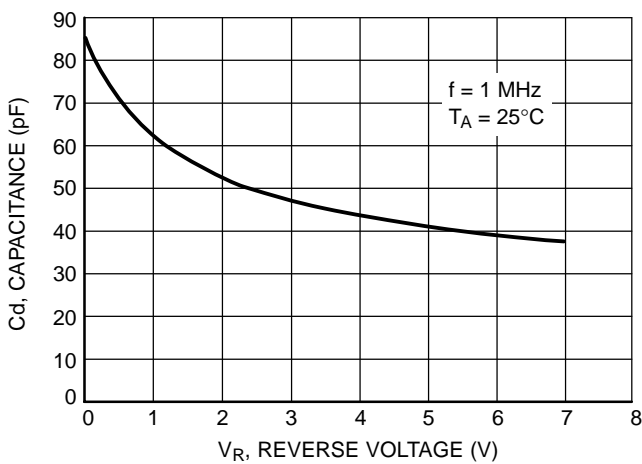

Figure 9. Capacitance

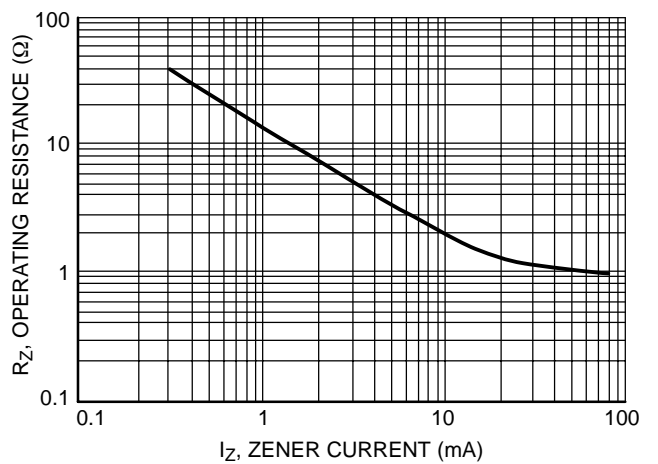
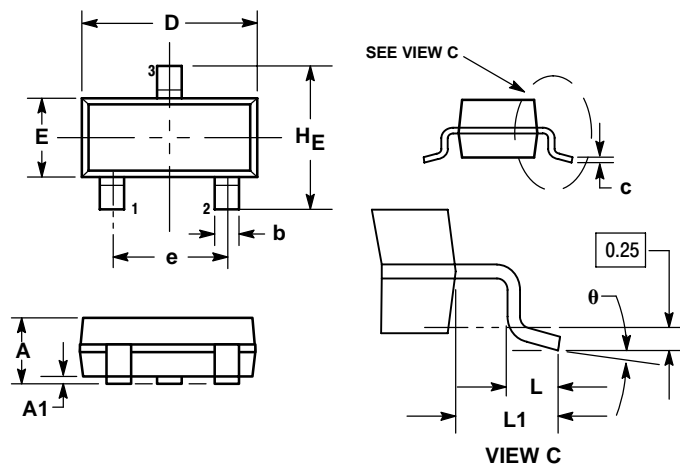

Figure 10. Operating Resistance versus Zener Current

# MA3075WALT1

SOT-23 (TO-236)  
CASE 318-08  
ISSUE AN



- NOTES:
1. DIMENSIONING AND TOLERANCING PER ANSI Y14.5M, 1982.
  2. CONTROLLING DIMENSION: INCH.
  3. MAXIMUM LEAD THICKNESS INCLUDES LEAD FINISH THICKNESS. MINIMUM LEAD THICKNESS IS THE MINIMUM THICKNESS OF BASE MATERIAL.
  4. 318-01 THRU -07 AND -09 OBSOLETE, NEW STANDARD 318-08.

| DIM | MILLIMETERS |      |      | INCHES |       |       |
|-----|-------------|------|------|--------|-------|-------|
|     | MIN         | NOM  | MAX  | MIN    | NOM   | MAX   |
| A   | 0.89        | 1.00 | 1.11 | 0.035  | 0.040 | 0.044 |
| A1  | 0.01        | 0.06 | 0.10 | 0.001  | 0.002 | 0.004 |
| b   | 0.37        | 0.44 | 0.50 | 0.015  | 0.018 | 0.020 |
| c   | 0.09        | 0.13 | 0.18 | 0.003  | 0.005 | 0.007 |
| D   | 2.80        | 2.90 | 3.04 | 0.110  | 0.114 | 0.120 |
| E   | 1.20        | 1.30 | 1.40 | 0.047  | 0.051 | 0.055 |
| e   | 1.78        | 1.90 | 2.04 | 0.070  | 0.075 | 0.081 |
| L   | 0.10        | 0.20 | 0.30 | 0.004  | 0.008 | 0.012 |
| L1  | 0.35        | 0.54 | 0.69 | 0.014  | 0.021 | 0.029 |
| HE  | 2.10        | 2.40 | 2.64 | 0.083  | 0.094 | 0.104 |

- STYLE 12:  
PIN 1. CATHODE  
2. CATHODE  
3. ANODE

## SOLDERING FOOTPRINT\*

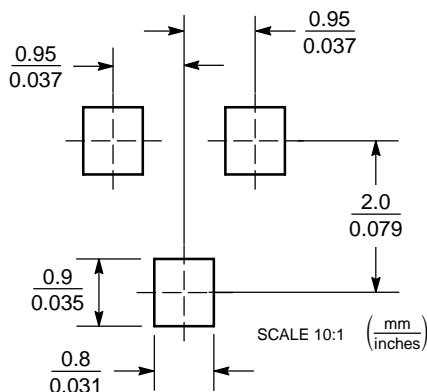

\*For additional information on our Pb-Free strategy and soldering details, please download the ON Semiconductor Soldering and Mounting Techniques Reference Manual, SOLDERRM/D.

ON Semiconductor and  are registered trademarks of Semiconductor Components Industries, LLC (SCILLC). SCILLC reserves the right to make changes without further notice to any products herein. SCILLC makes no warranty, representation or guarantee regarding the suitability of its products for any particular purpose, nor does SCILLC assume any liability arising out of the application or use of any product or circuit, and specifically disclaims any and all liability, including without limitation special, consequential or incidental damages. "Typical" parameters which may be provided in SCILLC data sheets and/or specifications can and do vary in different applications and actual performance may vary over time. All operating parameters, including "Typicals" must be validated for each customer application by customer's technical experts. SCILLC does not convey any license under its patent rights nor the rights of others. SCILLC products are not designed, intended, or authorized for use as components in systems intended for surgical implant into the body, or other applications intended to support or sustain life, or for any other application in which the failure of the SCILLC product could create a situation where personal injury or death may occur. Should Buyer purchase or use SCILLC products for any such unintended or unauthorized application, Buyer shall indemnify and hold SCILLC and its officers, employees, subsidiaries, affiliates, and distributors harmless against all claims, costs, damages, and expenses, and reasonable attorney fees arising out of, directly or indirectly, any claim of personal injury or death associated with such unintended or unauthorized use, even if such claim alleges that SCILLC was negligent regarding the design or manufacture of the part. SCILLC is an Equal Opportunity/Affirmative Action Employer. This literature is subject to all applicable copyright laws and is not for resale in any manner.

## PUBLICATION ORDERING INFORMATION

LITERATURE FULFILLMENT:  
Literature Distribution Center for ON Semiconductor  
P.O. Box 61312, Phoenix, Arizona 85082-1312 USA  
Phone: 480-829-7710 or 800-344-3860 Toll Free USA/Canada  
Fax: 480-829-7709 or 800-344-3867 Toll Free USA/Canada  
Email: orderlit@onsemi.com

N. American Technical Support: 800-282-9855 Toll Free  
USA/Canada

Japan: ON Semiconductor, Japan Customer Focus Center  
2-9-1 Kamimeguro, Meguro-ku, Tokyo, Japan 153-0051  
Phone: 81-3-5773-3850

ON Semiconductor Website: <http://onsemi.com>

Order Literature: <http://www.onsemi.com/litorder>

For additional information, please contact your local Sales Representative.