



FDBL9403_F085

N-Channel PowerTrench[®] MOSFET

40 V, 240 A, 0.9 mΩ

Features

- Typical $R_{DS(on)}$ = 0.65 mΩ at $V_{GS} = 10V$, $I_D = 80 A$
- Typical $Q_{g(tot)}$ = 144 nC at $V_{GS} = 10V$, $I_D = 80 A$
- UIS Capability
- RoHS Compliant
- Qualified to AEC Q101

Applications

- Automotive Engine Control
- PowerTrain Management
- Solenoid and Motor Drivers
- Integrated Starter/Alternator
- Primary Switch for 12V Systems

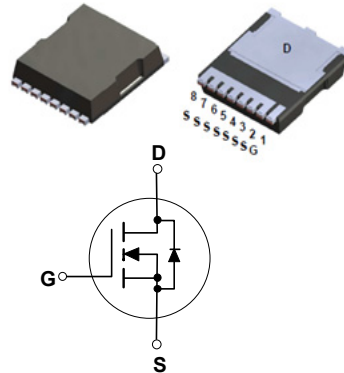

For current package drawing, please refer to the Fairchild website at <http://www.fairchildsemi.com/dwg/PS/PSOF08A.pdf>.

MOSFET Maximum Ratings $T_J = 25^\circ C$ unless otherwise noted.

| Symbol | Parameter | Rated | Units |
|-----------------|--|--------------------|---------------|
| V_{DSS} | Drain-to-Source Voltage | 40 | V |
| V_{GS} | Gate-to-Source Voltage | ±20 | V |
| I_D | Drain Current - Continuous ($V_{GS}=10$) (Note 1) | $T_C = 25^\circ C$ | 240 |
| | Pulsed Drain Current | $T_C = 25^\circ C$ | See Figure 4 |
| E_{AS} | Single Pulse Avalanche Energy (Note 2) | 737 | mJ |
| P_D | Power Dissipation | 357 | W |
| | Derate Above $25^\circ C$ | 2.38 | W/ $^\circ C$ |
| T_J, T_{STG} | Operating and Storage Temperature | -55 to + 175 | $^\circ C$ |
| $R_{\theta JC}$ | Thermal Resistance, Junction to Case | 0.42 | $^\circ C/W$ |
| $R_{\theta JA}$ | Maximum Thermal Resistance, Junction to Ambient (Note 3) | 43 | $^\circ C/W$ |

Notes:

- 1: Current is limited by bondwire configuration.
- 2: Starting $T_J = 25^\circ C$, $L = 0.36mH$, $I_{AS} = 64A$, $V_{DD} = 40V$ during inductor charging and $V_{DD} = 0V$ during time in avalanche.
- 3: $R_{\theta JA}$ is the sum of the junction-to-case and case-to-ambient thermal resistance, where the case thermal reference is defined as the solder mounting surface of the drain pins. $R_{\theta JC}$ is guaranteed by design, while $R_{\theta JA}$ is determined by the board design. The maximum rating presented here is based on mounting on a 1 in² pad of 2oz copper.

Package Marking and Ordering Information

| Device Marking | Device | Package | | | |
|----------------|---------------|---------|---|---|---|
| FDBL9403 | FDBL9403_F085 | MO-299A | - | - | - |

FDBL9403_F085 N-Channel PowerTrench[®] MOSFET

Electrical Characteristics $T_J = 25^\circ\text{C}$ unless otherwise noted.

| Symbol | Parameter | Test Conditions | Min. | Typ. | Max. | Units |
|--------|-----------|-----------------|------|------|------|-------|
|--------|-----------|-----------------|------|------|------|-------|

Off Characteristics

| | | | | | | |
|--------------|-----------------------------------|---|----|---|-----------|---------------|
| $B_{V_{DS}}$ | Drain-to-Source Breakdown Voltage | $I_D = 250\mu\text{A}$, $V_{GS} = 0\text{V}$ | 40 | - | - | V |
| I_{DSS} | Drain-to-Source Leakage Current | $V_{DS} = 40\text{V}$, $T_J = 25^\circ\text{C}$ | - | - | 1 | μA |
| | | $V_{GS} = 0\text{V}$, $T_J = 175^\circ\text{C}$ (Note 4) | - | - | 1 | mA |
| I_{GSS} | Gate-to-Source Leakage Current | $V_{GS} = \pm 20\text{V}$ | - | - | ± 100 | nA |

On Characteristics

| | | | | | | |
|--------------|----------------------------------|--|-----|------|------|------------|
| $V_{GS(th)}$ | Gate to Source Threshold Voltage | $V_{GS} = V_{DS}$, $I_D = 250\mu\text{A}$ | 2.0 | 3.3 | 4.0 | V |
| $R_{DS(on)}$ | Drain to Source On Resistance | $I_D = 80\text{A}$, $T_J = 25^\circ\text{C}$ | - | 0.65 | 0.90 | m Ω |
| | | $V_{GS} = 10\text{V}$, $T_J = 175^\circ\text{C}$ (Note 4) | - | 1.10 | 1.50 | m Ω |

Dynamic Characteristics

| | | | | | | |
|--------------|-------------------------------|---|---|-------|-----|----------|
| C_{iss} | Input Capacitance | $V_{DS} = 25\text{V}$, $V_{GS} = 0\text{V}$, $f = 1\text{MHz}$ | - | 12000 | - | pF |
| C_{oss} | Output Capacitance | | - | 3260 | - | pF |
| C_{rss} | Reverse Transfer Capacitance | | - | 442 | - | pF |
| R_g | Gate Resistance | $f = 1\text{MHz}$ | - | 3.3 | - | Ω |
| $Q_{g(ToT)}$ | Total Gate Charge at 10V | $V_{GS} = 0$ to 10V | - | 144 | 188 | nC |
| $Q_{g(th)}$ | Threshold Gate Charge | $V_{GS} = 0$ to 2V | | | | |
| Q_{gs} | Gate-to-Source Gate Charge | $V_{DD} = 32\text{V}$ $I_D = 80\text{A}$ | - | 66 | - | nC |
| Q_{gd} | Gate-to-Drain "Miller" Charge | | - | 16 | - | nC |

Switching Characteristics

| | | | | | | |
|--------------|----------------|---|---|----|-----|----|
| t_{on} | Turn-On Time | $V_{DD} = 20\text{V}$, $I_D = 80\text{A}$, $V_{GS} = 10\text{V}$, $R_{GEN} = 6\Omega$ | - | - | 162 | ns |
| $t_{d(on)}$ | Turn-On Delay | | - | 42 | - | ns |
| t_r | Rise Time | | - | 73 | - | ns |
| $t_{d(off)}$ | Turn-Off Delay | | - | 83 | - | ns |
| t_f | Fall Time | | - | 50 | - | ns |
| t_{off} | Turn-Off Time | | - | - | 279 | ns |

Drain-Source Diode Characteristics

| | | | | | | |
|----------|-------------------------------|---|---|-----|------|----|
| V_{SD} | Source-to-Drain Diode Voltage | $I_{SD} = 80\text{A}$, $V_{GS} = 0\text{V}$ | - | - | 1.25 | V |
| | | $I_{SD} = 40\text{A}$, $V_{GS} = 0\text{V}$ | - | - | 1.2 | V |
| t_{rr} | Reverse-Recovery Time | $I_F = 80\text{A}$, $dI_{SD}/dt = 100\text{A}/\mu\text{s}$ | - | 111 | 129 | ns |
| Q_{rr} | Reverse-Recovery Charge | $V_{DD} = 32\text{V}$ | - | 178 | 214 | nC |

Note:

 4: The maximum value is specified by design at $T_J = 175^\circ\text{C}$. Product is not tested to this condition in production.

Typical Characteristics

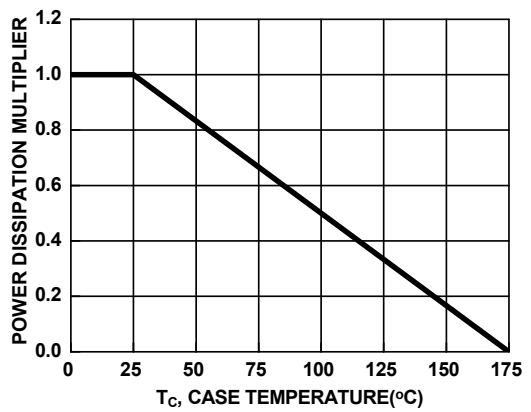

Figure 1. Normalized Power Dissipation vs. Case Temperature

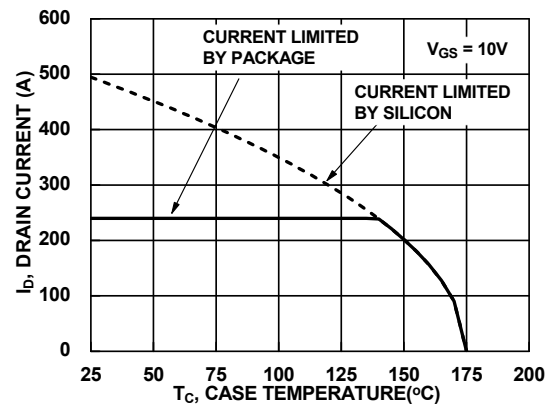

Figure 2. Maximum Continuous Drain Current vs. Case Temperature

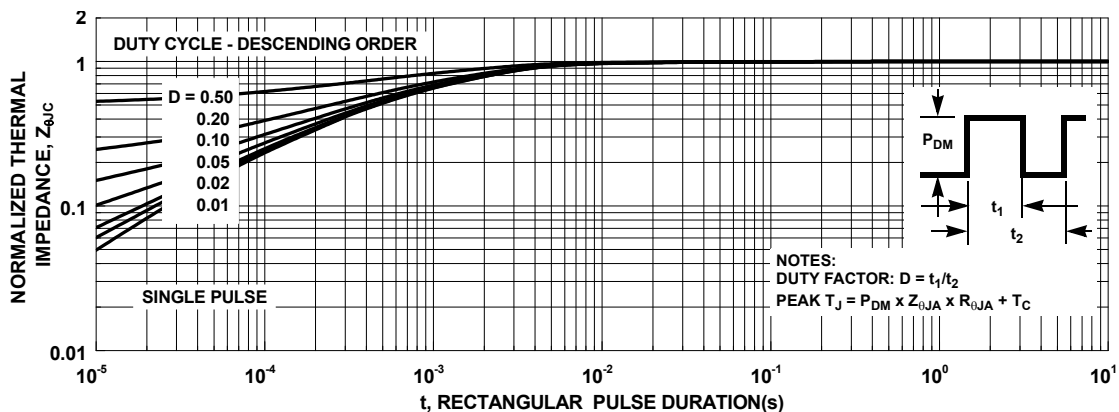

Figure 3. Normalized Maximum Transient Thermal Impedance

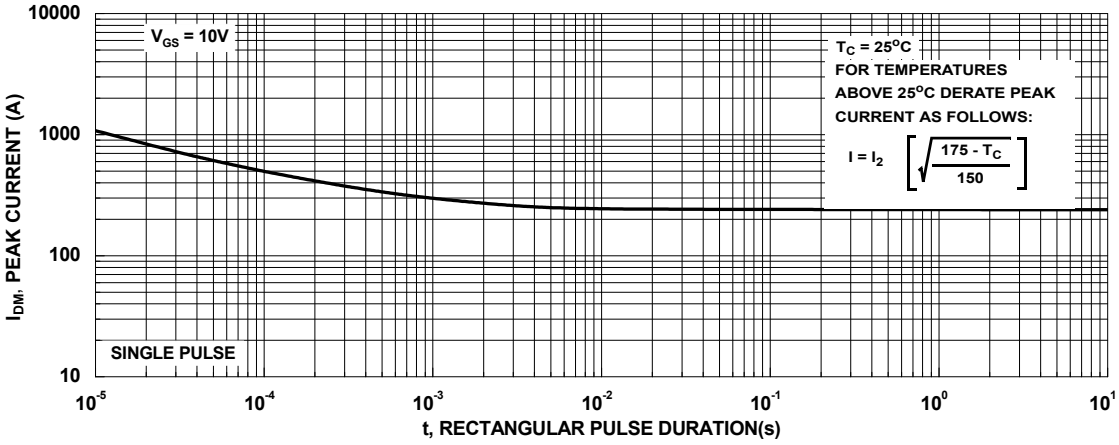

Figure 4. Peak Current Capability

Typical Characteristics

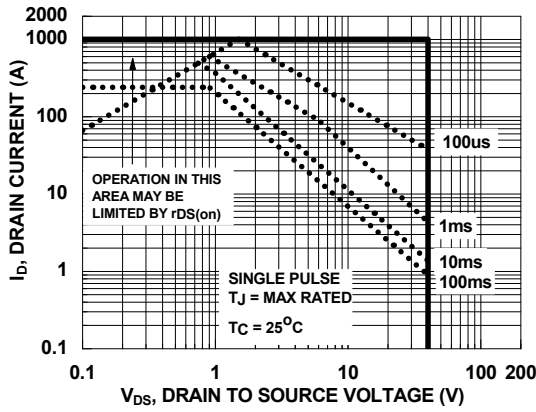
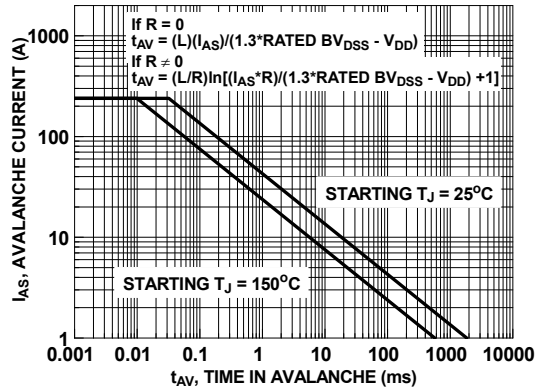

Figure 5. Forward Bias Safe Operating Area



NOTE: Refer to Fairchild Application Notes AN7514 and AN7515
 Figure 6. Unclamped Inductive Switching Capability

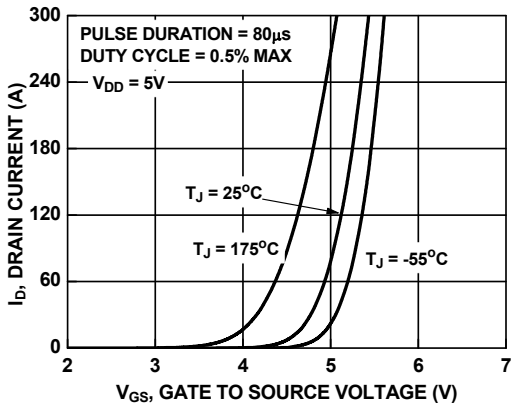

Figure 7. Transfer Characteristics

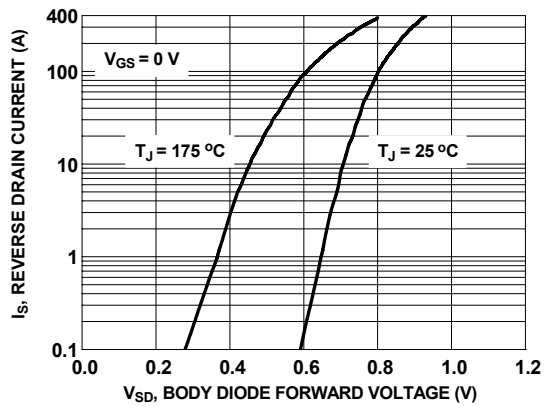

Figure 8. Forward Diode Characteristics

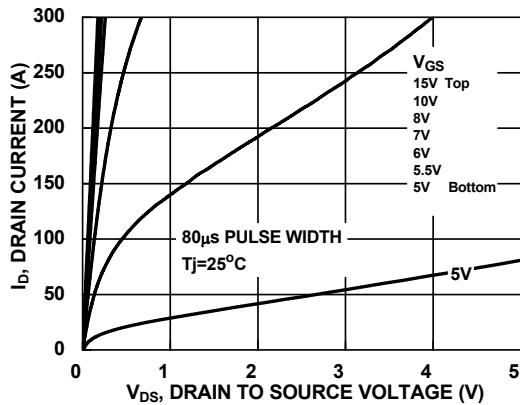

Figure 9. Saturation Characteristics

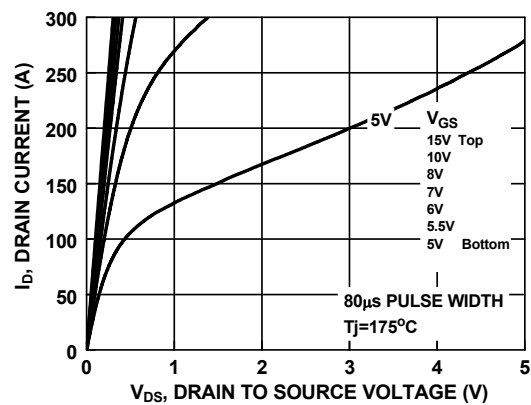

Figure 10. Saturation Characteristics

Typical Characteristics

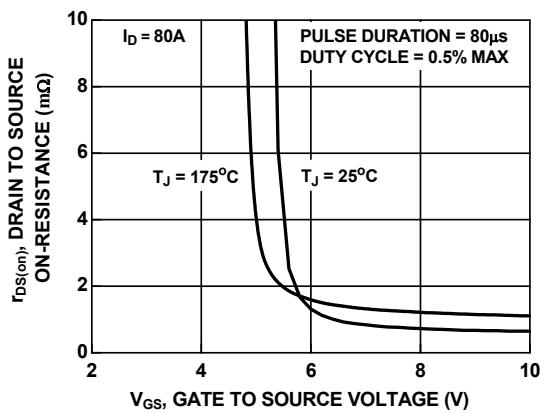

Figure 11. $R_{DS(on)}$ vs. Gate Voltage

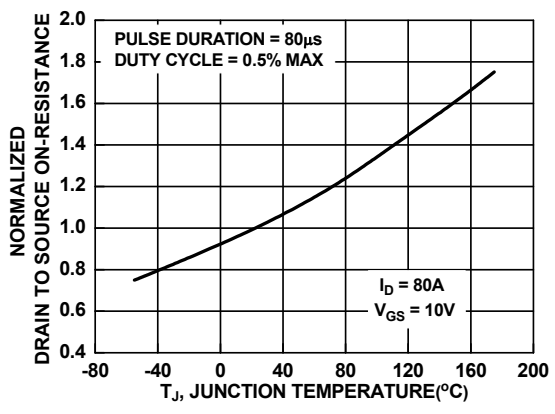

Figure 12. Normalized $R_{DS(on)}$ vs. Junction Temperature

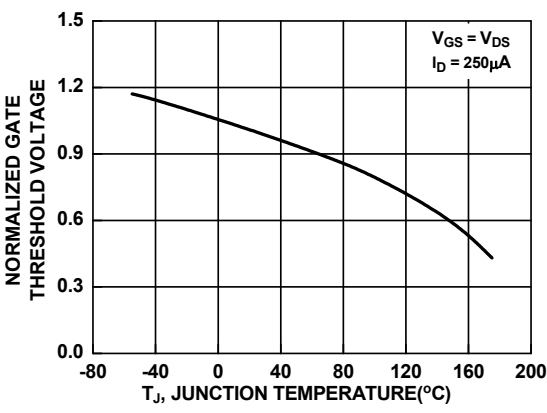

Figure 13. Normalized Gate Threshold Voltage vs. Temperature

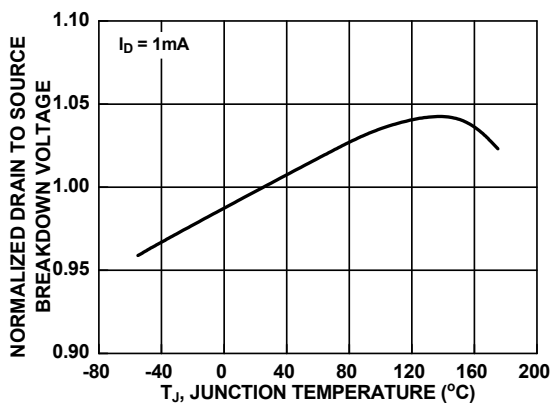

Figure 14. Normalized Drain to Source Breakdown Voltage vs. Junction Temperature

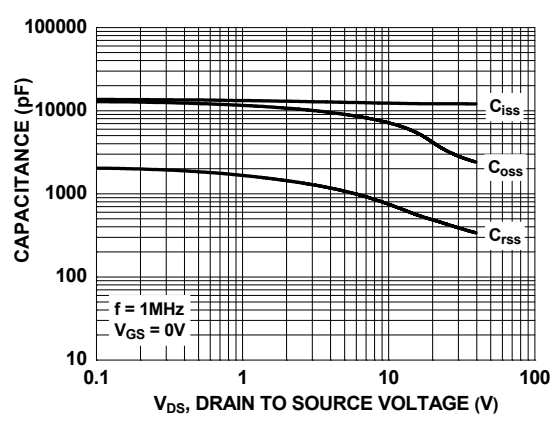

Figure 15. Capacitance vs. Drain to Source Voltage

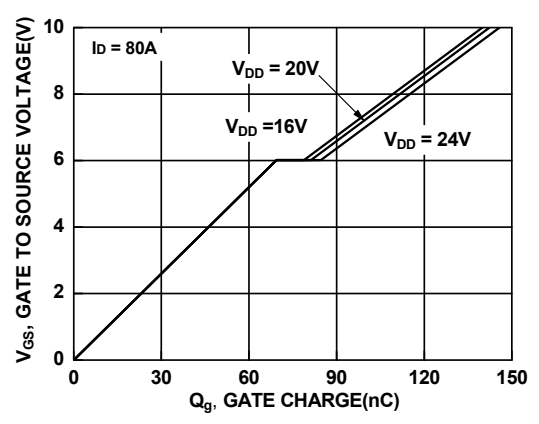







Figure 16. Gate Charge vs. Gate to Source Voltage



TRADEMARKS

The following includes registered and unregistered trademarks and service marks, owned by Fairchild Semiconductor and/or its global subsidiaries, and is not intended to be an exhaustive list of all such trademarks.

- | | | | |
|---|---|---|---|
| AccuPower™ | F-PFS™ |  |  |
| AX-CAP®* | FRFET® | PowerTrench® | TinyBoost® |
| BitSiC™ | Global Power ResourceSM | PowerXS™ | TinyBuck® |
| Build it Now™ | GreenBridge™ | Programmable Active Droop™ | TinyCalc™ |
| CorePLUS™ | Green FPS™ | QFET® | TinyLogic® |
| CorePOWER™ | Green FPS™ e-Series™ | QS™ | TINYOPTO™ |
| CROSSVOL™ | Gmax™ | Quiet Series™ | TinyPower™ |
| CTL™ | GTO™ | RapidConfigure™ | TinyPWM™ |
| Current Transfer Logic™ | IntelliMAX™ |  | TinyWire™ |
| DEUXPEED® | ISOPLANAR™ | Saving our world, 1mW/W/kW at a time™ | TranSiC™ |
| Dual Cool™ | Marking Small Speakers Sound Louder and Better™ | SignalWise™ | TriFault Detect™ |
| EcoSPARK® | MegaBuck™ | SmartMax™ | TRUECURRENT®* |
| EfficientMax™ | MICROCOUPLER™ | SMART START™ | µSerDes™ |
| ESBC™ | MicroFET™ | Solutions for Your Success™ |  |
|  | MicroPak™ | SPM® | UHC® |
| Fairchild® | MicroPak2™ | STEALTH™ | Ultra FRFET™ |
| Fairchild Semiconductor® | MillerDrive™ | SuperFET® | UniFET™ |
| FACT Quiet Series™ | MotionMax™ | SuperSOT™-3 | VCX™ |
| FACT® | mWSaver® | SuperSOT™-6 | VisualMax™ |
| FAST® | OptoHit™ | SuperSOT™-8 | VoltagePlus™ |
| FastvCore™ | OPTOLOGIC® | SupreMOS® | XS™ |
| FETBench™ | OPTOPLANAR® | SyncFET™ | 仙童™ |
| FPS™ | | Sync-Lock™ | |

*Trademarks of System General Corporation, used under license by Fairchild Semiconductor.

DISCLAIMER

FAIRCHILD SEMICONDUCTOR RESERVES THE RIGHT TO MAKE CHANGES WITHOUT FURTHER NOTICE TO ANY PRODUCTS HEREIN TO IMPROVE RELIABILITY, FUNCTION, OR DESIGN. FAIRCHILD DOES NOT ASSUME ANY LIABILITY ARISING OUT OF THE APPLICATION OR USE OF ANY PRODUCT OR CIRCUIT DESCRIBED HEREIN; NEITHER DOES IT CONVEY ANY LICENSE UNDER ITS PATENT RIGHTS, NOR THE RIGHTS OF OTHERS. THESE SPECIFICATIONS DO NOT EXPAND THE TERMS OF FAIRCHILD'S WORLDWIDE TERMS AND CONDITIONS, SPECIFICALLY THE WARRANTY THEREIN, WHICH COVERS THESE PRODUCTS.

LIFE SUPPORT POLICY

FAIRCHILD'S PRODUCTS ARE NOT AUTHORIZED FOR USE AS CRITICAL COMPONENTS IN LIFE SUPPORT DEVICES OR SYSTEMS WITHOUT THE EXPRESS WRITTEN APPROVAL OF FAIRCHILD SEMICONDUCTOR CORPORATION.

As used here in:

- Life support devices or systems are devices or systems which, (a) are intended for surgical implant into the body or (b) support or sustain life, and (c) whose failure to perform when properly used in accordance with instructions for use provided in the labeling, can be reasonably expected to result in a significant injury of the user.
- A critical component in any component of a life support, device, or system whose failure to perform can be reasonably expected to cause the failure of the life support device or system, or to affect its safety or effectiveness.

ANTI-COUNTERFEITING POLICY

Fairchild Semiconductor Corporation's Anti-Counterfeiting Policy. Fairchild's Anti-Counterfeiting Policy is also stated on our external website, www.Fairchildsemi.com, under Sales Support.

Counterfeiting of semiconductor parts is a growing problem in the industry. All manufactures of semiconductor products are experiencing counterfeiting of their parts. Customers who inadvertently purchase counterfeit parts experience many problems such as loss of brand reputation, substandard performance, failed application, and increased cost of production and manufacturing delays. Fairchild is taking strong measures to protect ourselves and our customers from the proliferation of counterfeit parts. Fairchild strongly encourages customers to purchase Fairchild parts either directly from Fairchild or from Authorized Fairchild Distributors who are listed by country on our web page cited above. Products customers buy either from Fairchild directly or from Authorized Fairchild Distributors are genuine parts, have full traceability, meet Fairchild's quality standards for handling and storage and provide access to Fairchild's full range of up-to-date technical and product information. Fairchild and our Authorized Distributors will stand behind all warranties and will appropriately address and warranty issues that may arise. Fairchild will not provide any warranty coverage or other assistance for parts bought from Unauthorized Sources. Fairchild is committed to combat this global problem and encourage our customers to do their part in stopping this practice by buying direct or from authorized distributors.

PRODUCT STATUS DEFINITIONS

Definition of Terms

| Datasheet Identification | Product Status | Definition |
|--------------------------|-----------------------|---|
| Advance Information | Formative / In Design | Datasheet contains the design specifications for product development. Specifications may change in any manner without notice. |
| Preliminary | First Production | Datasheet contains preliminary data; supplementary data will be published at a later date. Fairchild Semiconductor reserves the right to make changes at any time without notice to improve design. |
| No Identification Needed | Full Production | Datasheet contains final specifications. Fairchild Semiconductor reserves the right to make changes at any time without notice to improve the design. |
| Obsolete | Not In Production | Datasheet contains specifications on a product that is discontinued by Fairchild Semiconductor. The datasheet is for reference information only. |