





PAD	CONNECTION
1	Enable/Disable
2	Ground
3	Output
4	Supply

Scale 4:1

## Features

-  **Low current consumption**
-  **Enable / disable tristate function**
-  **Miniature ceramic package with metal lid**
-  **Competitive pricing**

## Standard Frequencies

Frequencies in MHz			
1.84320	12.00000	25.00000	49.15200
2.00000	14.31818	27.00000	50.00000
3.68640	16.00000	30.00000	66.00000
4.00000	18.43200	32.00000	75.00000
5.00000	20.00000	40.00000	
8.00000	24.00000	44.00000	
10.00000	24.57600	48.00000	

Other frequencies available. Please consult our sales office.

## Enable / Disable Function

Input (pad 1)	Output (pad 3)
Open	Enabled
'1' level	Enabled
'0' level	High Impedance

## Specifications

**GXO-3201G: 1.8V supply**

**GXO-3201L: 2.5V ~ 3.3V supply**

Parameters	Variant		Option Codes
	G	L	
<b>Frequency range:</b> 0.50 ~ 50.0MHz 0.75 ~ 75.0MHz	■	■	
<b>Frequency stability*:</b> ±100ppm ±50ppm ±30ppm	■ □ □	■ □ □	B E
<b>Operating temperature range:</b> -20 to +70°C -40 to +85°C	■ □	■ □	I
<b>Storage temperature range:</b> -55 to +100°C	■	■	
<b>Supply voltage (V<sub>DD</sub>):</b> +1.8V (±5%) +2.5V ~ 3.3V (±5%) (see note 1)	■	■	
<b>Supply current (max):</b> ≤ 20.0MHz >20.0 ~ 30.0MHz >30.0 ~ 40.0MHz >40.0 ~ 50.0MHz >50.0 ~ 60.0MHz >60.0 ~ 75.0MHz (see note 2)	2.5 2.5 3.0 3.5	6 11 11 16 16 20	
<b>Logic levels:</b> '0' level = 10%V <sub>DD</sub> max '1' level = 90%V <sub>DD</sub> min	■ ■	■ ■	
<b>Start up time:</b> 10ms max	■	■	
<b>Waveform symmetry:</b> 45:55 @ 50%V <sub>DD</sub>	■	■	
<b>Driving ability:</b> 15pF HCMOS	■	■	
<b>Rise / fall time:</b> 10ns max	■	■	
<b>Enable / disable function:</b> Tristate (control via pad 1) E/D times 10ms / 50µs E/D times 10ms / 200ns	■ ■	■ ■	
<b>Period jitter RMS:</b> 5ps max	■	■	
<b>Phase jitter RMS:</b> 1ps max, 12kHz~20MHz	■	■	
<b>Ageing:</b> ±5ppm / year max	■	■	

■ Standard. □ Optional - Please specify required code(s) when ordering

\* Frequency stability is inclusive of calibration @ 25°C, operating temperature range, supply voltage change, load change, shock and vibration.

## Ordering Information

Product name + variant + option codes (if any) + frequency  
eg: **GXO-3201L/E 40.0MHz** 2.5~3.3V, 30ppm, -20+70°C  
**GXO-3201G/BI 24.5760MHz** 1.8V, ±50ppm, -40+85°C

- ◆ 1: GXO-3201L will operate within specification on any supply voltage from +2.5V to +3.3V.
- ◆ 2: Supply current for GXO-3201L will vary with supply voltage. Figures shown are for 3.0V supply.

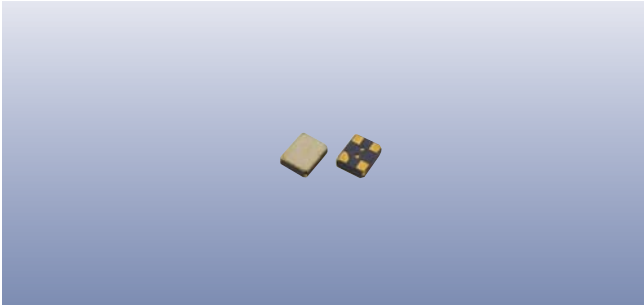

## Construction

- ▮▮▮▮ **Ceramic body with gold-plated pads**
- ▮▮▮▮ **Metal lid, seam sealed**

## Composition



This product is lead-free, and is fully compliant with the RoHS directive 2002/95/EC



## Packaging & Handling

Production quantities supplied on T & R, 1k or 3k pcs per reel.  
Small quantities may be supplied on tape (no reel), or in bulk.



◆ Static sensitive product. Observe proper handling precautions

## Marking

FREQUENCY  
DC

Marking type: Laser  
DC = Date code in YM, eg "CE" = May 2003

	A	B	C	D	E	F	G	H	J	K	L	M
Y	1	2	3	4	5	6	7	8	9	0		
M	Jan	Feb	Mar	Apr	May	Jun	Jul	Aug	Sep	Oct	Nov	Dec

## Tape & Reel Specification

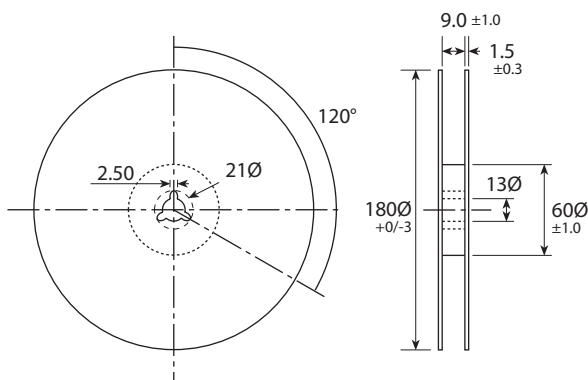
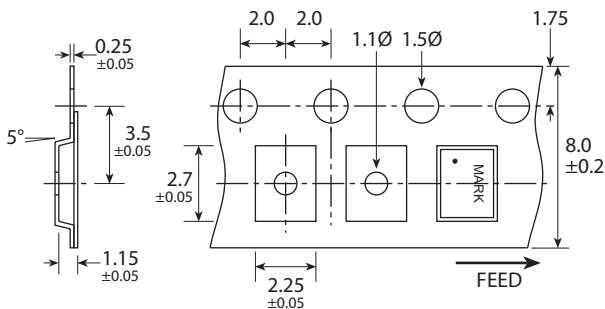

Not to scale. Dimensions in mm. Tolerances ±0.1mm unless otherwise stated

## Soldering Profile

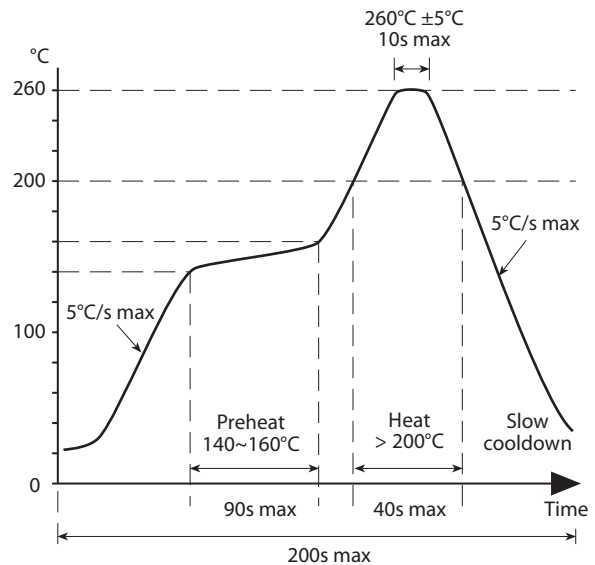

Solder resistance: 260°C x 10 secs x 2.