

Xinger®

Ultra Low Profile 0805 Power Divider 3 Way 50Ω to 50Ω

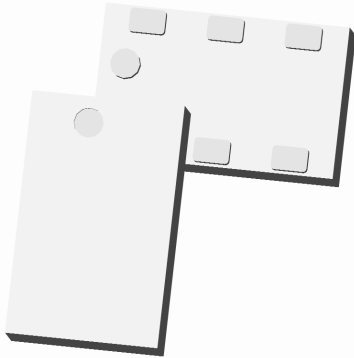

Description

The PD1722J5050S3HF is a low profile, sub-miniature Wilkinson power divider in an easy to use surface mount package and is ideal for high volume manufacturing while delivering higher performances than traditional printed and lumped element solutions. It has been designed for the DCS, PCS, UMTS and CDMA markets. The PD1722J5050S3HF is matched to 50 Ω and has a height profile of 0.82 mm. Three external resistors are required for operation. Components are available on tape and reel for high volume manufacturing pick and place.

Detailed Electrical Specifications: Specifications subject to change without notice.

Features:	Parameter	ROOM (25°C)			Unit
		Min.	Typ.	Max	
<ul style="list-style-type: none"> • 1700 – 2200 MHz • 0.82 mm Height Profile • 50Ω Outputs/Inputs • DCS/PCS/UMTS/CDMA • External resistors required • Low Insertion Loss • Surface Mountable • Tape & Reel • Non-conductive Surface • RoHS Compliant • Halogen Free 	Frequency	1700		2200	MHz
	Input Port Impedance		50		Ω
	Output Port Impedance		50		Ω
	Return Loss	9	11		dB
	Insertion Loss*		0.9	1.3	dB
	Amplitude Balance		0.5	0.9	dB
	Phase Balance		9	12	Degrees
	Isolation (Output Ports)	14	17		dB
	Power Handling			1	Watts
	Operating Temperature	-55		+85	°C

* Insertion Loss stated at room temperature (Insertion Loss is approximately 0.1 dB higher at +85 °C)

Outline Drawing

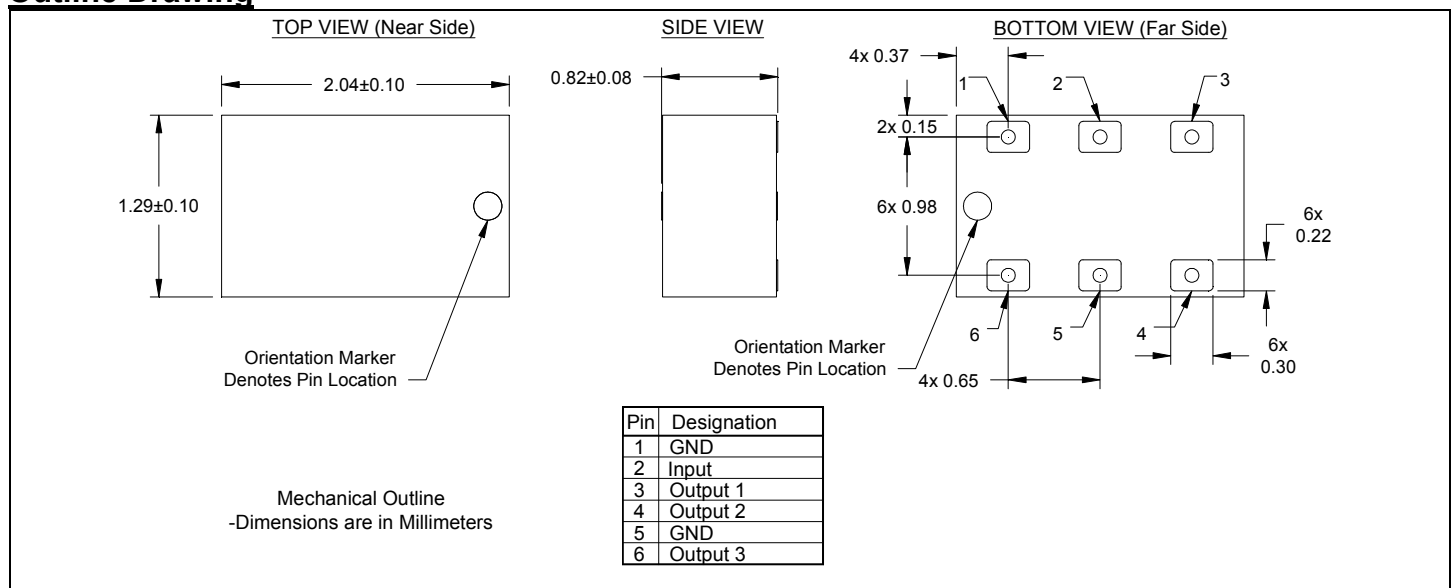

Typical Broadband Performance: 500 MHz. to 8.5 GHz.

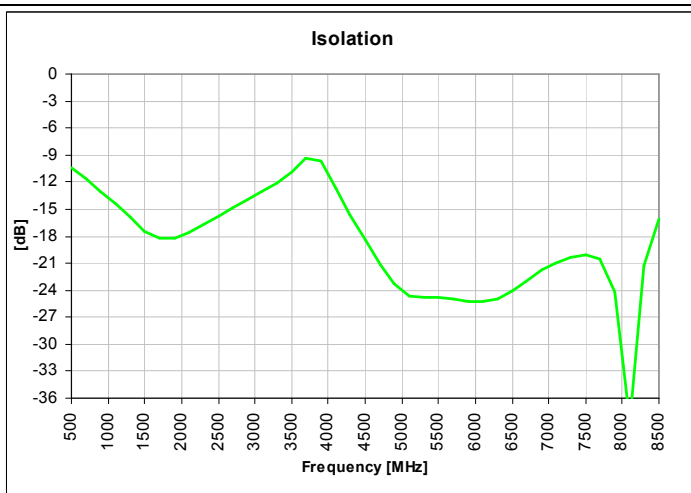
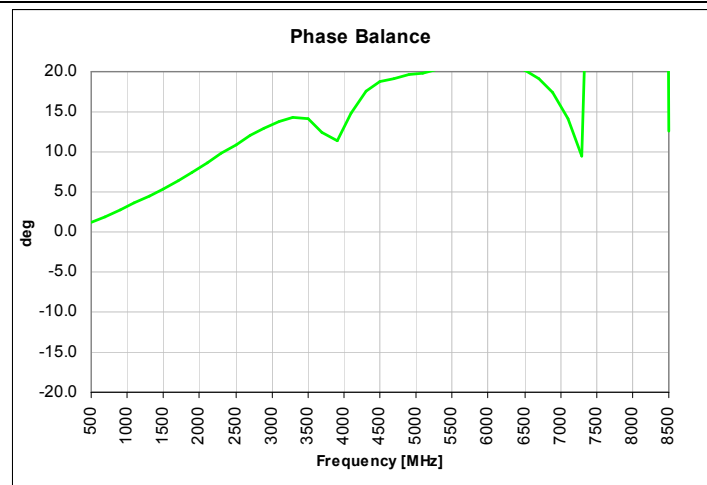
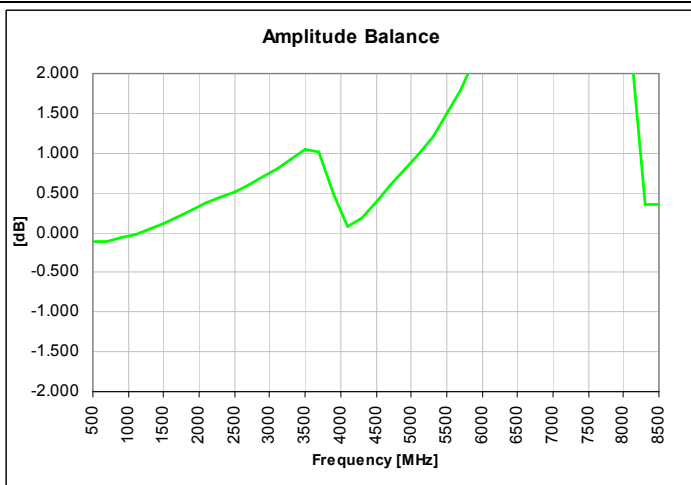
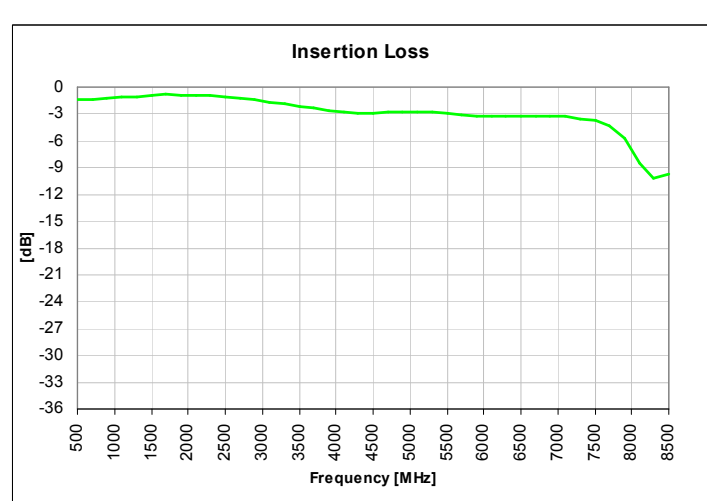
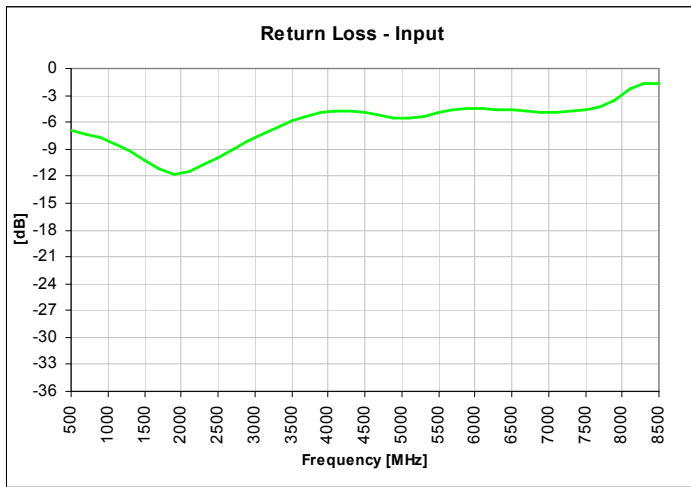

Typical Performance: 1600 MHz. to 2300 MHz.

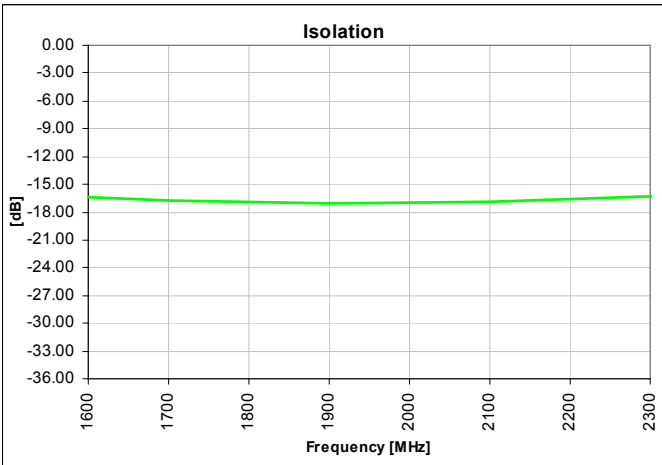
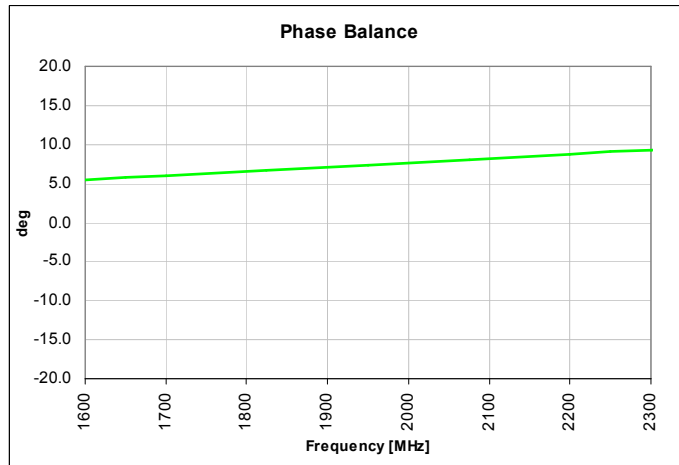
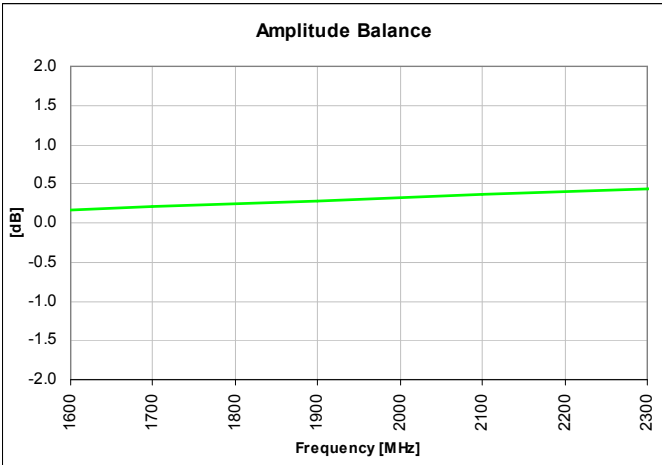
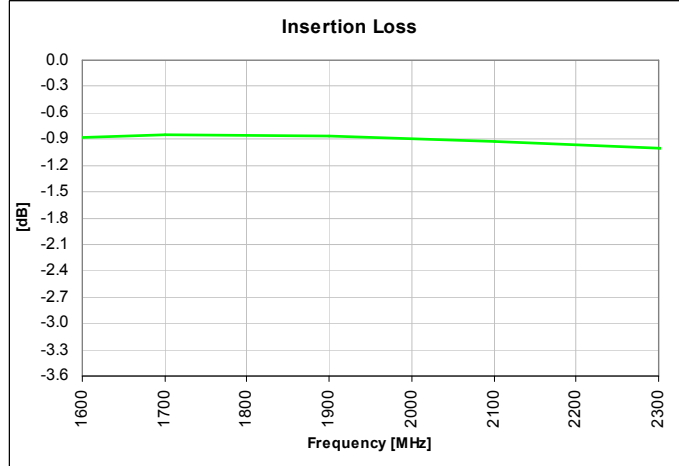
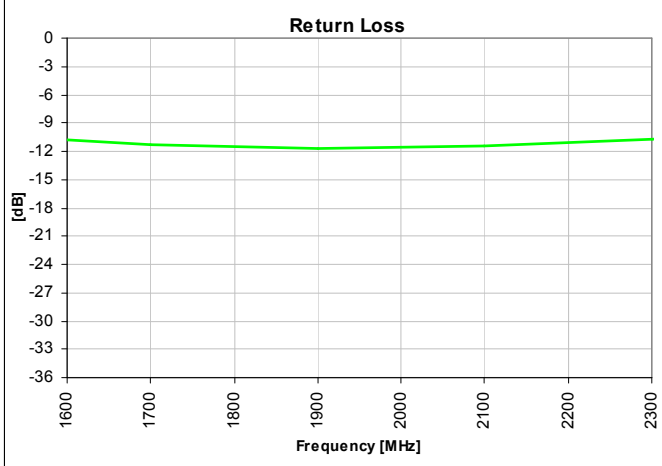

Mounting Configuration:

In order for Xinger surface mount components to work optimally, the proper impedance transmission lines must be used to connect to the RF ports. If this condition is not satisfied, insertion loss, Isolation and VSWR may not meet published specifications.

All of the Xinger components are constructed from organic PTFE based composites which possess excellent electrical and mechanical stability. Xinger components are compliant to a variety of ROHS and Green standards and ready for Pb-free soldering processes. Pads are Gold plated with a Nickel barrier.

An example of the PCB footprint used in the testing of these parts is shown below. In specific designs, the transmission line widths need to be adjusted to the unique dielectric coefficients and thicknesses as well as varying pick and place equipment tolerances. In addition, since the PD1722J5050S3HF is a Wilkinson power divider, external 0402 100Ω resistors must be mounted as shown in the Figure below.

Pad Footprint w/ 0402 Resistor Locations

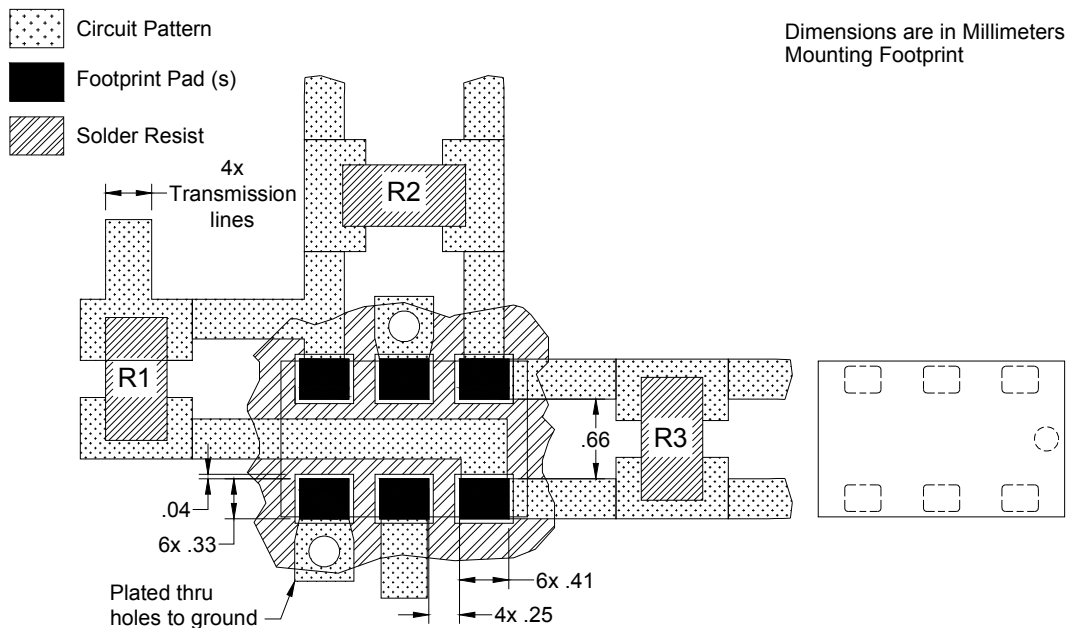

Packaging and Ordering Information

Parts are available in reels and are packaged per EIA 481-2. Parts are oriented in tape and reel as shown below. Minimum order quantities are 4000 per reel. See Model Numbers below for further ordering information.

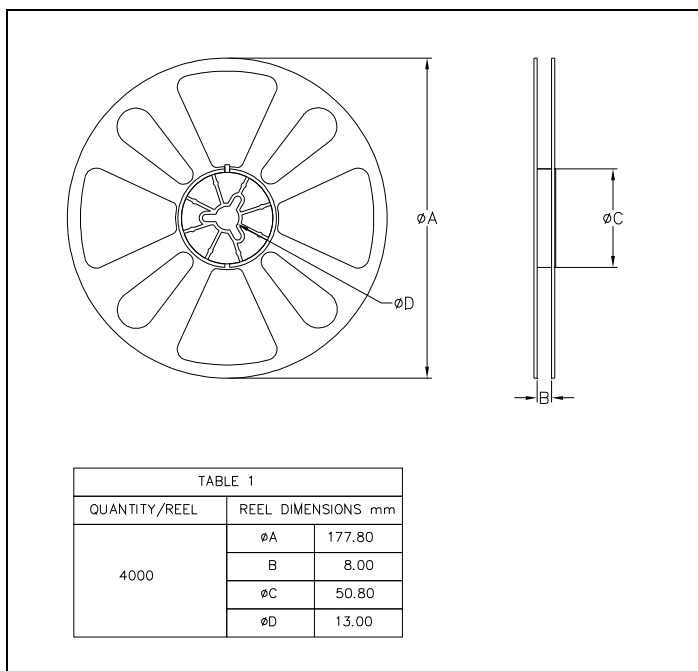
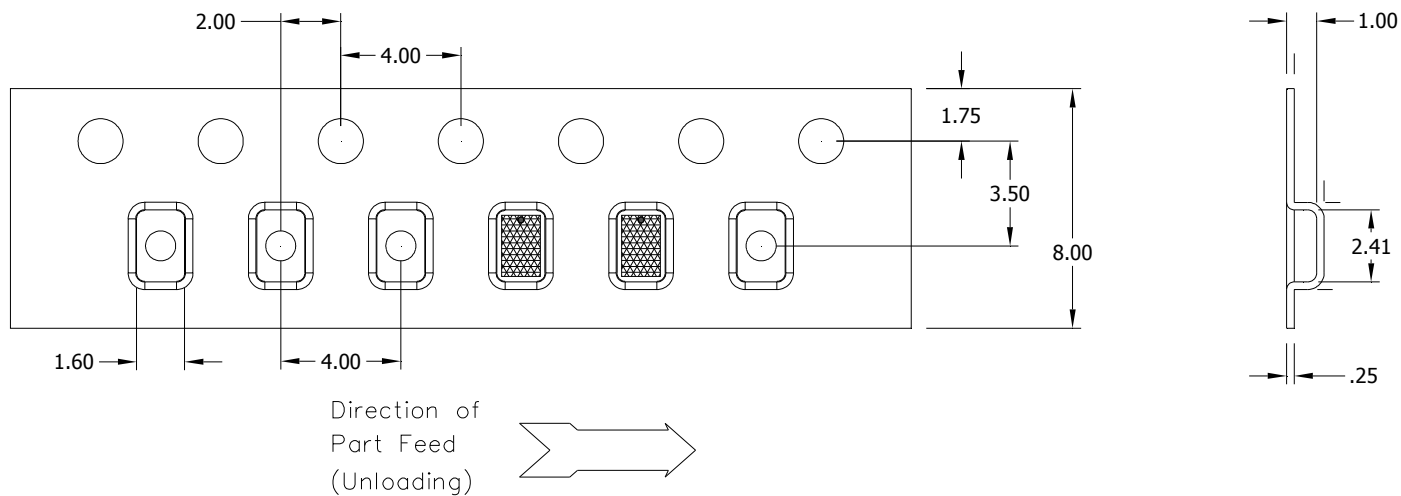

Mouser Electronics

Authorized Distributor

Click to View Pricing, Inventory, Delivery & Lifecycle Information:

[Anaren:](#)

[PD1722J5050S3HF](#)