

### 3.3V 256K Static RAM 32K x 8-Bit Low Voltage Revolutionary Pinout

#### Features

- High-speed access times
  - Com'1: 12, 15, 17 and 20 ns
  - Ind'1: 15, 17 and 20 ns
- Low power operation (typical)
  - PDM31356SA
    - Active: 200 mW
    - Standby: 50 mW
- Single +3.3V ( $\pm 0.3V$ ) power supply
- TTL-compatible inputs and outputs
- Packages
  - Plastic SOJ (300 mil) - SO
  - Plastic TSOP - T

#### Description

The PDM31356 is a high-performance CMOS static RAM organized as 32,768 x 8 bits. This product is produced in Paradigm's proprietary CMOS technology which offers the designer the highest speed parts. Writing to this device is accomplished when the write enable ( $\overline{WE}$ ) and the chip enable ( $\overline{CE}$ ) inputs are both LOW. Reading is accomplished when  $\overline{WE}$  remains HIGH and  $\overline{CE}$  and  $\overline{OE}$  are both LOW.

The PDM31356 operates from a single +3.3V power supply and all the inputs and outputs are fully TTL-compatible.

The PDM31356 is available in a 32-pin plastic TSOP and a 32-pin 300-mil plastic SOJ.

#### Functional Block Diagram

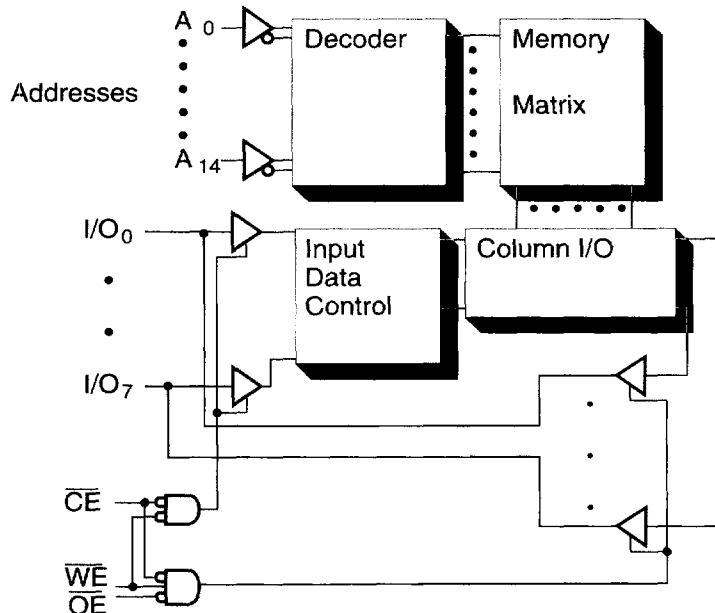

Pin Configurations

TSOP

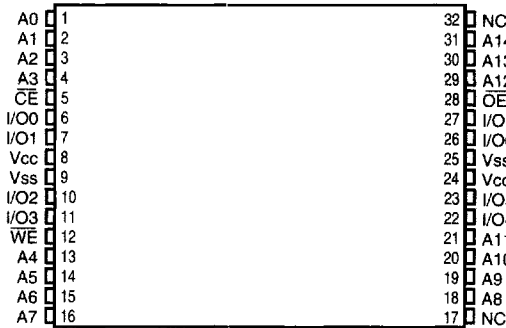

SOJ

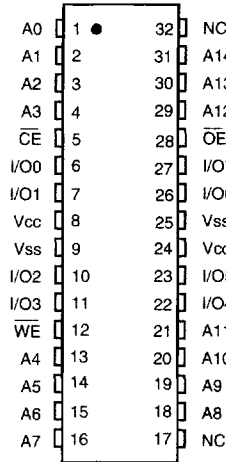

Pin Description

Name	Description
A14-A0	Address Inputs
I/O7-I/O0	Data Inputs/Outputs
OE	Output Enable Input
WE	Write Enable Input
CE	Chip Enable Input
NC	No Connect
V <sub>CC</sub>	Power (+3.3V)
V <sub>SS</sub>	Ground

Truth Table

OE	WE	CE	I/O	MODE
X	X	H	Hi-Z	Standby
L	H	L	D <sub>OUT</sub>	Read
X	L	L	D <sub>IN</sub>	Write
H	H	L	Hi-Z	Output Disable

NOTE: 1. H = V<sub>IH</sub>, L = V<sub>IL</sub>, X = DON'T CARE

Absolute Maximum Ratings <sup>(1)</sup>

Symbol	Rating	Com'l.	Ind.	Unit
V <sub>TERM</sub>	Terminal Voltage with Respect to Vss	-0.5 to +4.6	-0.5 to +4.6	V
T <sub>BIAS</sub>	Temperature Under Bias	-55 to +125	-65 to +135	°C
T <sub>STG</sub>	Storage Temperature	-55 to +125	-65 to +150	°C
P <sub>T</sub>	Power Dissipation	1.0	1.0	W
I <sub>OUT</sub>	DC Output Current	50	50	mA
T <sub>J</sub>	Maximum Junction Temperature <sup>(2)</sup>	125	125	°C

- NOTE: 1. Stresses greater than those listed under ABSOLUTE MAXIMUM RATINGS may cause permanent damage to the device. This is a stress rating only and functional operation of the device at these or any other conditions above those indicated in the operational sections of this specification is not implied. Exposure to absolute maximum rating conditions for extended periods may affect reliability.
2. Appropriate thermal calculations should be performed in all cases and specifically for those where the chosen package has a large thermal resistance (e.g., TSOP). The calculation should be of the form:  $T_j = T_a + P * \theta_{ja}$  where  $T_a$  is the ambient temperature, P is average operating power and  $\theta_{ja}$  the thermal resistance of the package. For this product, use the following  $\theta_{ja}$  values:

SOJ: 76° C/W  
 TSOP: 107° C/W

**Recommended DC Operating Conditions**

Symbol	Parameter	Min.	Typ.	Max.	Unit
V <sub>CC</sub>	Supply Voltage	3.0	3.3	3.6	V
V <sub>SS</sub>	Supply Voltage	0	0	0	V
Commercial	Ambient Temperature	0	25	70	°C
Industrial	Ambient Temperature	-40	25	85	°C

**DC Electrical Characteristics (V<sub>CC</sub> = 3.3V ± 0.3V)**

Symbol	Parameter	Test	Min.	Max.	Unit	
I <sub>LI</sub>	Input Leakage Current	V <sub>CC</sub> = MAX., V <sub>IN</sub> = V <sub>SS</sub> to V <sub>CC</sub>	Com'l/ Ind.	-5	5	μA
I <sub>LO</sub>	Output Leakage Current	V <sub>CC</sub> = MAX., CE = V <sub>IH</sub> , V <sub>OUT</sub> = V <sub>SS</sub> to V <sub>CC</sub>	Com'l/ Ind.	-5	5	μA
V <sub>IL</sub>	Input Low Voltage			-0.3 <sup>(1)</sup>	0.8	V
V <sub>IH</sub>	Input High Voltage			2.2	V <sub>CC</sub> +0.3	V
V <sub>OL</sub>	Output Low Voltage	I <sub>OL</sub> = 8 mA, V <sub>CC</sub> = Min. I <sub>OL</sub> = 10 mA, V <sub>CC</sub> = Min.		— —	0.4 0.5	V
V <sub>OH</sub>	Output High Voltage	I <sub>OH</sub> = -4 mA, V <sub>CC</sub> = Min.		2.4	—	V

NOTE: 1. V<sub>IL</sub>(min) = -3.0V for pulse width less than 20 ns.



**Power Supply Characteristics**

Symbol	Parameter	-12		-15		-17		-20		Unit
		Com'l.	Com'l.	Ind.	Com'l.	Ind.	Com'l.	Ind.		
I <sub>CC</sub>	Operating Current CE = V <sub>IL</sub>  f = f <sub>MAX</sub> = 1/t <sub>RC</sub> V <sub>CC</sub> = Max. I <sub>OUT</sub> = 0 mA	130	120	120	120	120	110	110	mA	
I <sub>SB</sub>	Standby Current CE = V <sub>IH</sub>  f = f <sub>MAX</sub> = 1/t <sub>RC</sub> V <sub>CC</sub> = Max.	40	35	35	35	35	30	30	mA	
I <sub>SB1</sub>	Full Standby Current CE ≥ V <sub>HC</sub>  f = 0 V <sub>CC</sub> = Max., V <sub>IN</sub> ≥ V <sub>CC</sub> - 0.2V or ≤ 0.2V	10	10	15	10	15	10	15	mA	

NOTES: All values are maximum guaranteed values.  
V<sub>LC</sub> ≤ 0.2V, V<sub>HC</sub> ≥ V<sub>CC</sub> - 0.2V

**Capacitance<sup>(1)</sup>** ( $T_A = +25^\circ\text{C}$ ,  $f = 1.0\text{ MHz}$ )

Symbol	Parameter	Max.	Unit
$C_{IN}$	Input Capacitance	8	pF
$C_{OUT}$	Output Capacitance	8	pF

NOTE: 1. This parameter is determined by device characterization but is not production tested.

**AC Test Conditions**

Input pulse levels	$V_{SS}$ to 3.0V
Input rise and fall times	2.5 ns
Input timing reference levels	1.8V
Output reference levels	1.5V
Output load	See Figures 1 and 2

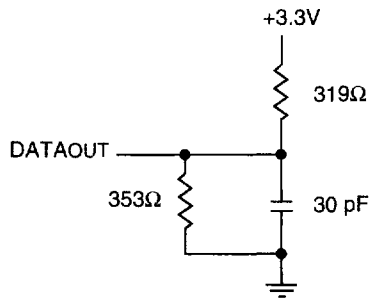

Figure 1. Output Load Equivalent

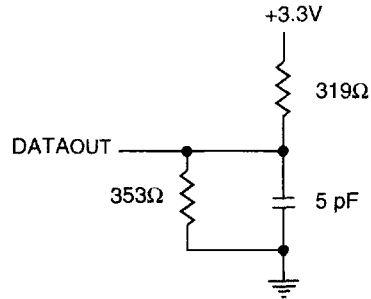

Figure 2. Output Load Equivalent  
(for  $t_{LZCE}$ ,  $t_{HZCE}$ ,  $t_{LZWE}$ ,  $t_{HZWE}$ ,  $t_{LZOE}$ ,  $t_{HZOE}$ )

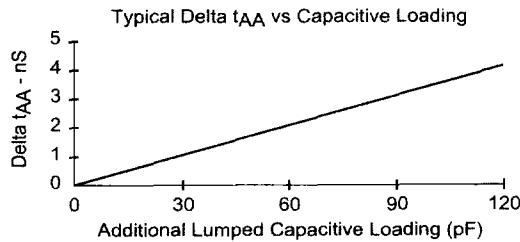
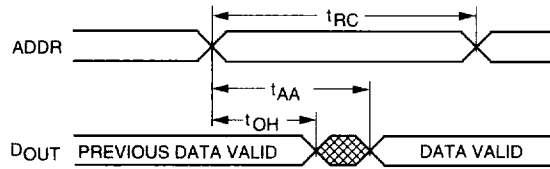
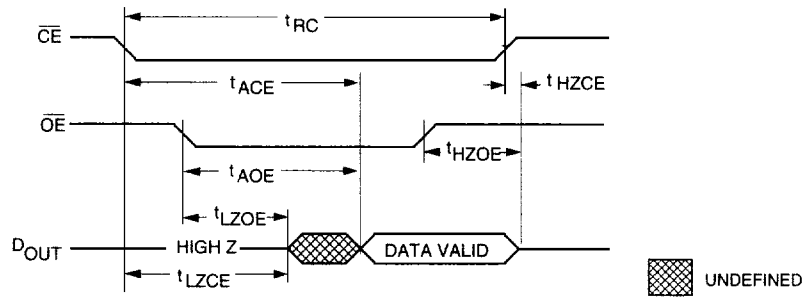

Figure 3.

Read Cycle No. 1<sup>(1)</sup>



Read Cycle No. 2<sup>(2)</sup>



AC Electrical Characteristics

Description		-12		-15		-17		-20		
READ Cycle	Sym	Min.	Max.	Min.	Max.	Min	Max	Min	Max	Units
READ cycle time	t <sub>RC</sub>	12		15		17		20		ns
Address access time	t <sub>AA</sub>		12		15		17		20	ns
Chip enable access time	t <sub>ACE</sub>		12		15		17		20	ns
Output hold from address change	t <sub>OH</sub>	3		3		3		3		ns
Chip enable to output in low Z <sup>(3,4,5)</sup>	t <sub>LZCE</sub>	5		5		5		5		ns
Chip disable to output in high Z <sup>(3,4,5)</sup>	t <sub>HZCE</sub>		10		10		12		15	ns
Chip enable to power up time <sup>(4)</sup>	t <sub>PU</sub>	0		0		0		0		ns
Chip disable to power down time <sup>(4)</sup>	t <sub>PD</sub>		12		15		17		20	ns
Output enable access time	t <sub>AOE</sub>		6		8		9		10	ns
Output enable to output in low Z <sup>(4,5)</sup>	t <sub>LZOE</sub>	0		0		0		0		ns
Output disable to output in high Z <sup>(4,5)</sup>	t <sub>HZOE</sub>		8		8		8		8	ns

**Write Cycle No. 1 (Write Enable Controlled)**

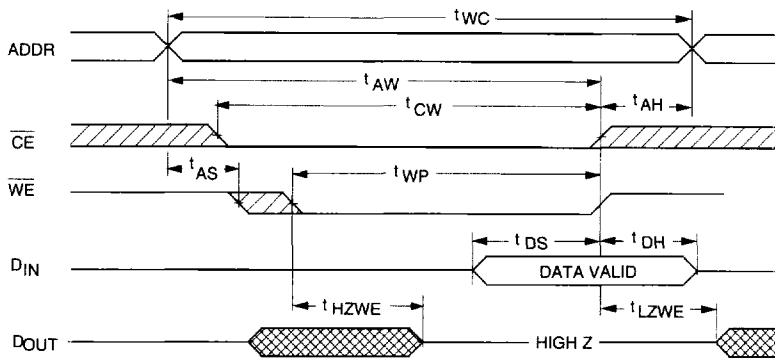

**Write Cycle No. 2 (Chip Enable Controlled)**

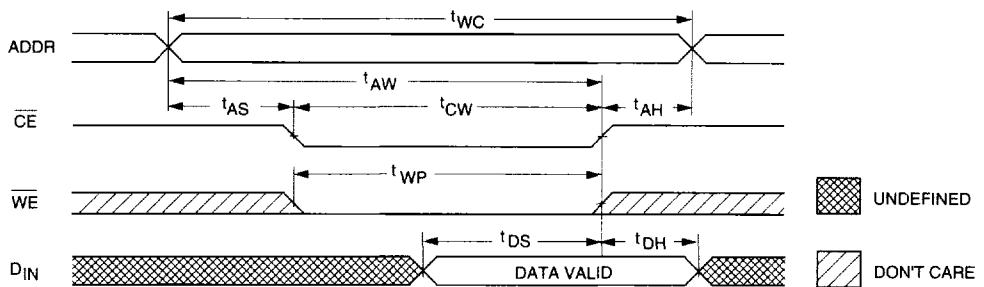

**AC Electrical Characteristics**

Description	Sym	-12		-15		-17		-20		Units
		Min.	Max.	Min.	Max.	Min.	Max.	Min.	Max.	
WRITE cycle time	t <sub>WC</sub>	12		15		17		20		ns
Chip enable to end of write	t <sub>CW</sub>	10		12		12		13		ns
Address valid to end of write	t <sub>AW</sub>	10		12		12		13		ns
Address setup time	t <sub>AS</sub>	0		0		0		0		ns
Address hold from end of write	t <sub>AH</sub>	0		0		0		0		ns
Write pulse width	t <sub>WP</sub>	10		11		11		12		ns
Data setup time	t <sub>DS</sub>	7		7		8		9		ns
Data hold time	t <sub>DH</sub>	0		0		0		0		ns
Write disable to output in low Z <sup>(4,5)</sup>	t <sub>LZWE</sub>	0		0		0		0		ns
Write enable to output in high Z <sup>(4,5)</sup>	t <sub>HZWE</sub>		3		3		3		3	ns

NOTES: (For two previous Electrical Characteristics tables)

1. The device is continuously selected. Chip Enable is held in its active state.
2. The address is valid prior to or coincident with the latest occurring Chip Enable.
3. At any given temperature and voltage condition,  $t_{HZCE}$  is less than  $t_{LZCE}$ .
4. This parameter is sampled.
5. The parameter is tested with  $CL = 5 \text{ pF}$  as shown in Figure 2. Transition is measured  $\pm 200 \text{ mV}$  from steady state voltage.

**Ordering Information**

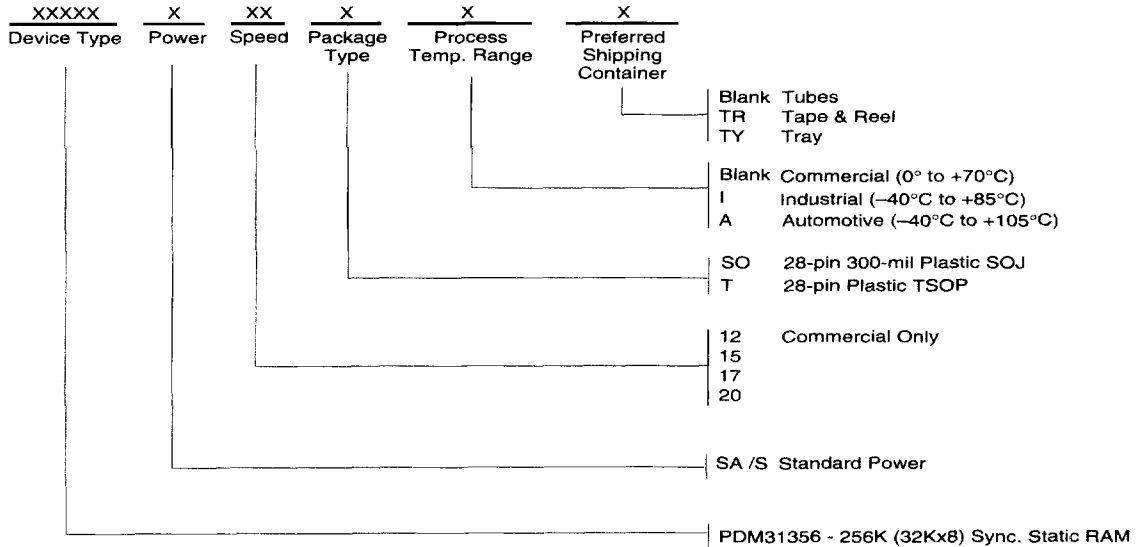

*Faster Memories for a FasterWorld™*