

High Efficiency 1×/1.5× Charge Pump 4-Channels LED Driver

DESCRIPTION

BL8587 is a low noise, high efficiency, and constant frequency charge pump DC/DC converter for white LED application. The operation frequency is 1MHz.

BL8587 works in load switch (1×) and fractional (1.5×) modes with four independent control outputs, each channel can provide 20mA constant current precisely from a 2.8V to 5.5V supply. Only two external 1μF and two 0.47μF capacitors are required to build a compact and low-cost power supply solution.

BL8587 uses EN pin for simple on/off control and single wire serial pulse dimming in 16 steps. A low current shutdown feature disconnects the load from V_{IN} and reduces quiescent current to less than 1μA.

FEATURES

- Input range: 2.8-5.5V
- ±1% LED current accuracy
- 20mA driver capacity each channel
- Auto 1×/1.5× mode switchover
- PWM dimming control
- Serial-pulse dimming control in linear 16 steps
- Short-circuit protection
- Thermal shutdown
- 1MHz constant switching frequency
- 3mm×3mm QFN package

APPLICATION

- Programmable Current Sinks
- White LED Backlighting
- Cell Phones and Smart phones
- PDAs, Digital Cameras, and Camcorders
- Color (RGB) Lighting

TYPICAL APPLICATION CIRCUIT

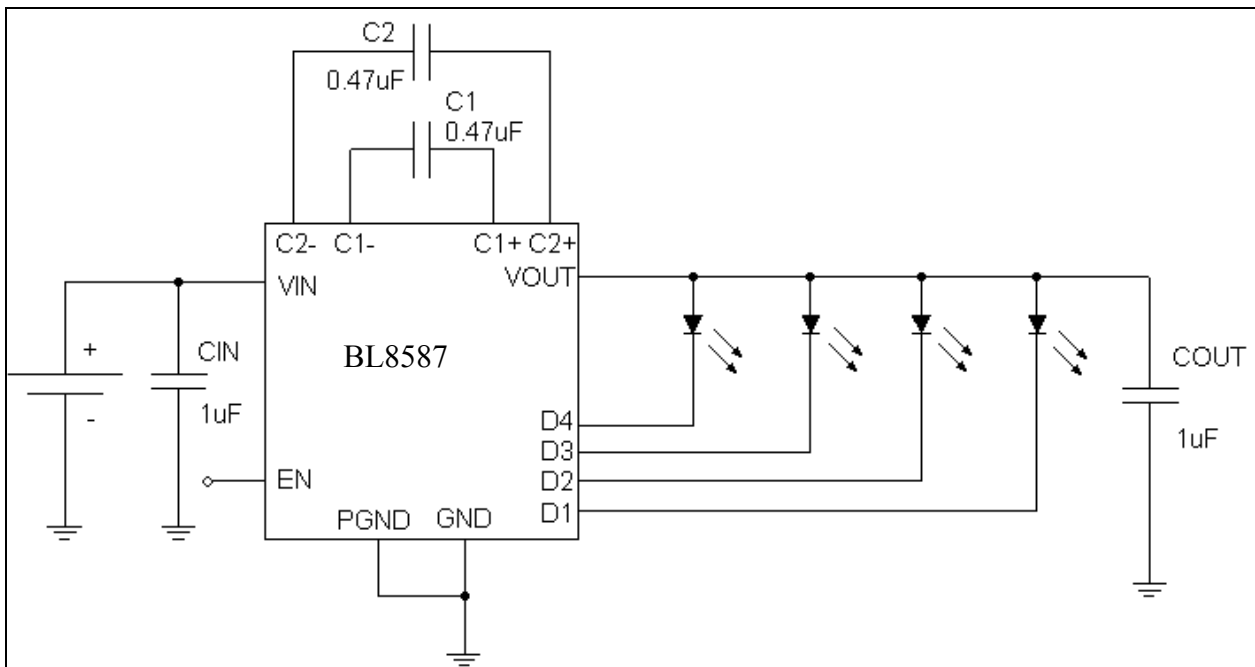

PIN DISCRPTIONS

Pin No.	Symbol	Description
1	NC	No connection
2	NC	No connection
3	D4	Channel 4 sink current input
4	D3	Channel 3 sink current input
5	D2	Channel 2 sink current input
6	D1	Channel 1 sink current input
7	GND	Signal ground
8	VOUT	Charge pump output to drive load circuit, a 1 μ F capacitor should be used to short this pin to ground.
9	C2+	Flying capacitor 2 positive terminal. Connect a 1 μ F capacitor between C2+ and C2-.
10	C1+	Flying capacitor 1 positive terminal. Connect a 1 μ F capacitor between C1+ and C1-.
11	C1-	Flying capacitor 1 negative terminal.
12	C2-	Flying capacitor 2 negative terminal.
13	VIN	Power supply input, a 1 μ F capacitor is required to connect this pin to ground.
14	PGND	Power ground
15	NC	No connection
16	EN	Enable pin and can use this pin to program the sink current.

PIN CONFIGURATION

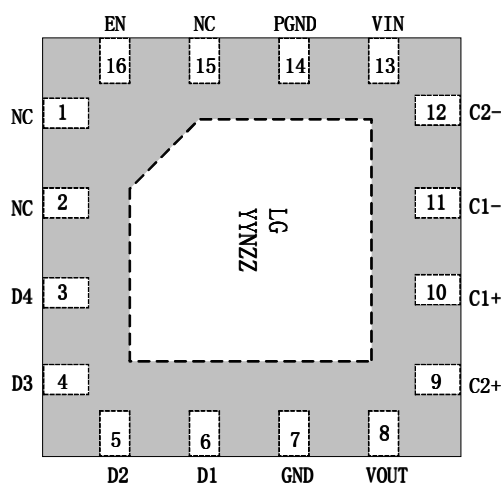

Top view QFN 3mm×3mm

Marking :
 LG: Product code
 YY: LOT NO.
 N: Fab code
 ZZ: Date code

ORDERING INFORMATION

Product NO	Ordering Number	Pin Package	Devices per reel	Temperature range & Rohs
BL8587	BL8587CJKTR	3*3 QFN-16	3000	-40~85°C & Pb free

ABSOLUTE MAXIMUM RATING

Item	Description	Value	Unit
VIN	Input supply voltage	-0.3-6	V
Iomax	Maximum load current	100	mA
TJ	Operating junction temperature range	-40-150	°C

ELECTRICAL CHARACTERISTICS

$C_{IN}=C_{OUT}=1\mu F$, $C_1=C_2=0.47\mu F$, $T_a=25^\circ C$, unless otherwise noted.

Symbol	Description	Condition	Min	Typical	Max	Unit
V_{IN}	Supply voltage range		2.8		5.5	V
V_{UVLO}	Under voltage-lockout threshold		2.5		2.8	V
I_Q	Quiescent operating current	1x mode/No load current		0.3	0.5	mA
		1.5x mode/No load current			6	
I_{SD}	Shutdown current	EN=0		1		μA
I_{LED}	Sink current accuracy	$I_{SET}=20mA$	-10		+10	%
V_{TH}	1.5x mode to 1x mode transition threshold			3.7		V
R_{OUT}	Open loop out resistance	1x mode, (Vin-Vout)/Iout		2.2		Ω
		1.5x mode, (1.5Vin-Vout)/Iout		5		
V_{EN}	Enable voltage	Logic high voltage	1.2			V
		Logic low voltage			0.4	
T_{EN_PULSE}	The positive and negative pulse width of EN pin	Dimming control	4		20	μS
$V_{DROPOUT}$	D pin Dropout voltage	100% LED current setting (Note1)		120		mV
I_{SHORT}	Output short current	Short output to ground		100		mA
F_{OSC}	Oscillator frequency		0.7	1	1.3	MHZ
TSD	Thermal shutdown temperature			150		$^\circ C$
$T_{_H}$	Thermal shutdown hysteric			30		$^\circ C$

Note1: Dropout voltage is defined as the D pin to GND voltage at which current into D pin drops 10% from the value at $V_D=0.2V$.

BLOCK DIAGRAM

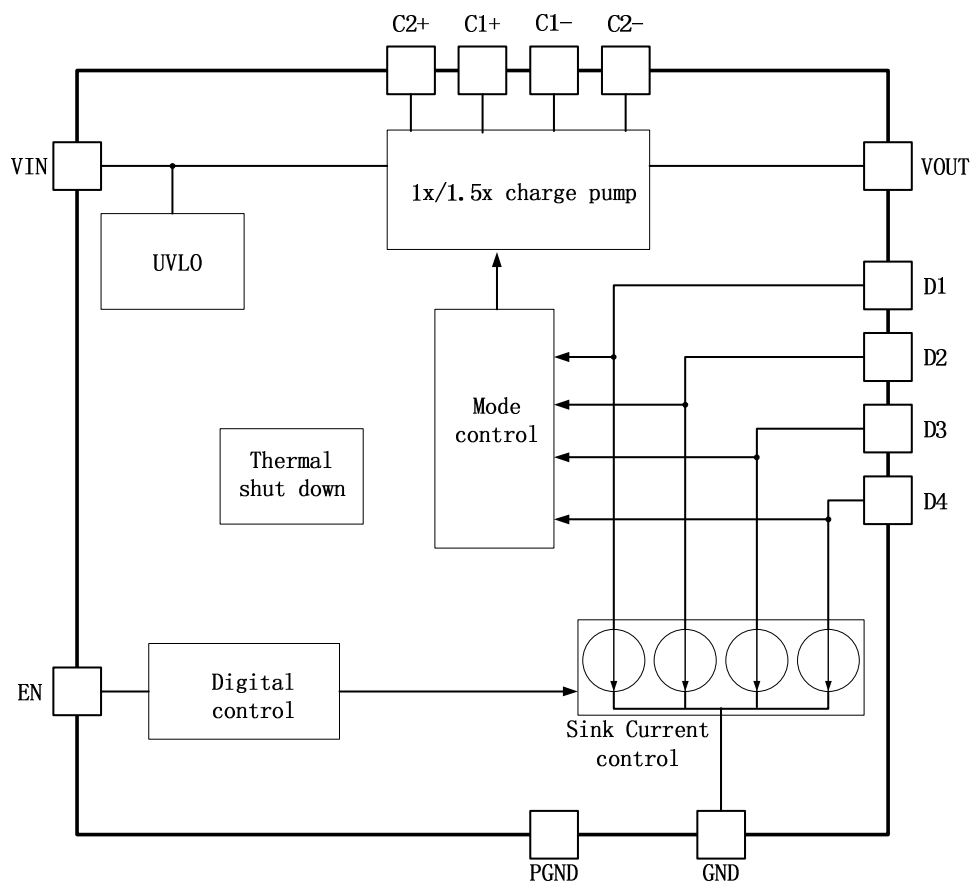

TYPICAL CHARACTERISTICS

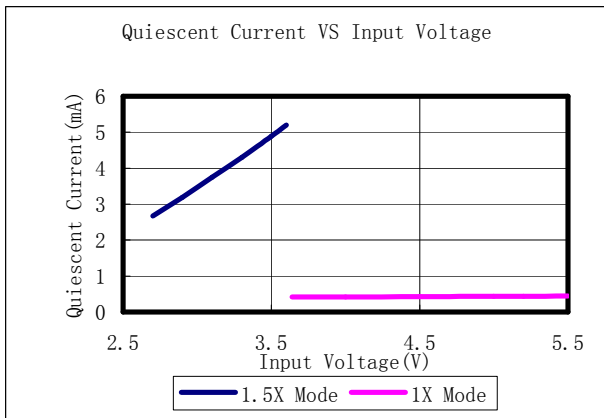
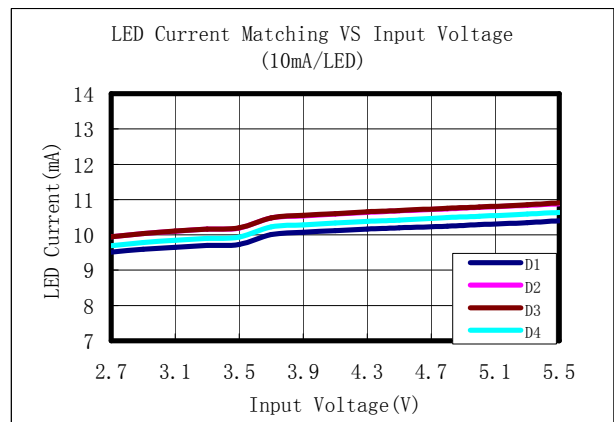
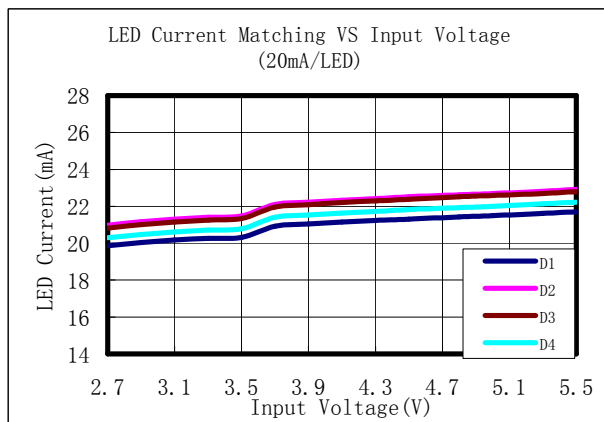
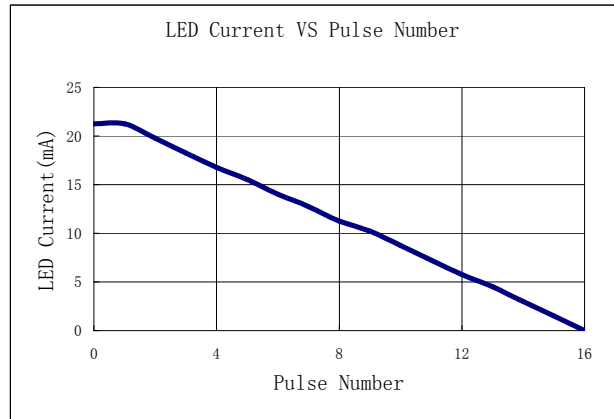
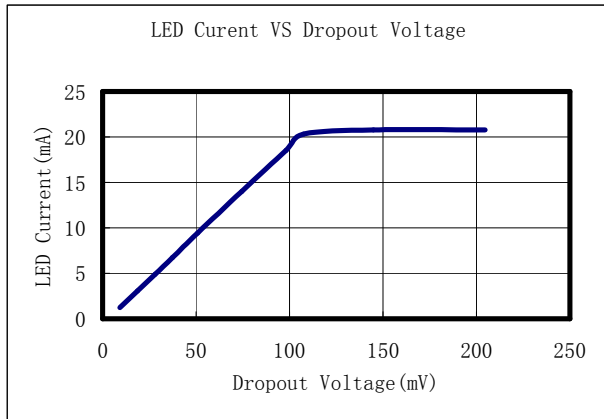

OPERATION WAVEFORMS

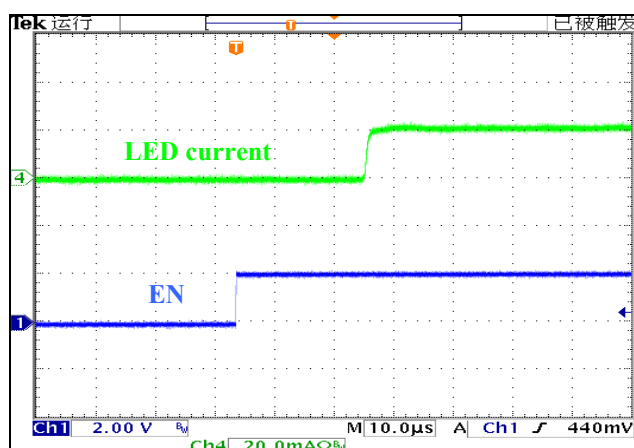

Fig. 1 Startup from EN pin

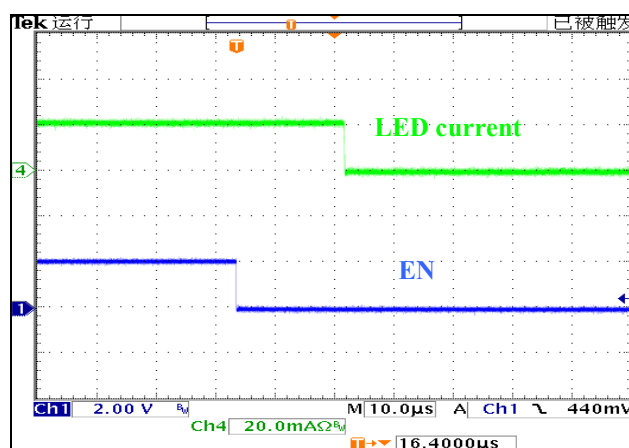

Fig. 2 Shutdown from EN pin

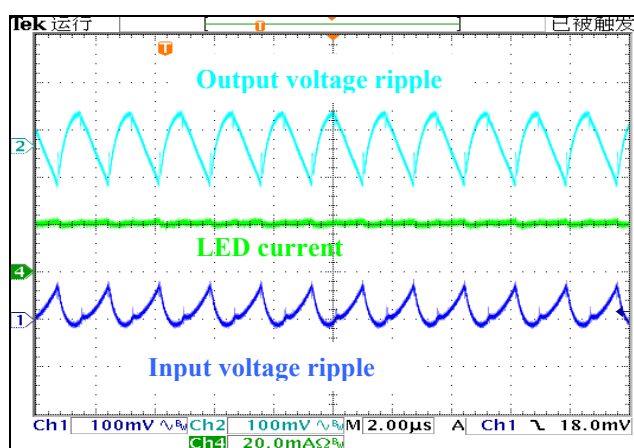

Fig. 3 Operating at 1.5x mode with 100% brightness

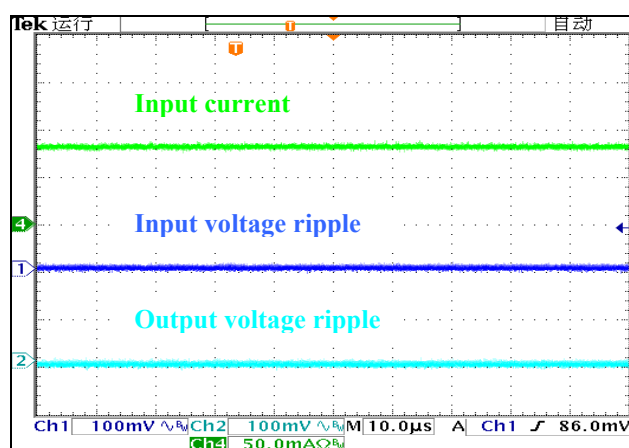

Fig. 4 Operating at 1x mode with 100% brightness

DETAIL DESCRIPTION

Startup sequence

The BL8587 starts to work only when VIN powered on and the EN pin became high after a delay, the delay time is at least 4us. EN pin is not allowed to connect to VIN directly or keep it floating.

The BL8587 starts with 1X mode, the output follows closely to the supply voltage. If the average voltage of pin D1 to D4 falls below 0.25V the IC switches to 1.5X mode, and it can automatically switch back to 1X mode when the input voltage is higher than 3.7V.

PWM dimming control

If the frequency of the PWM signal to the EN pin is less than 5KHz, the average LED current is proportional to the duty cycle of the PWM signal, and the EN works as a simple on/off control. A high level turns on and a low shuts down the LEDs. There is a delay time between the input PWM signal and the output LED current waveform, as shown in Fig.5, the T_D is about 20uS.

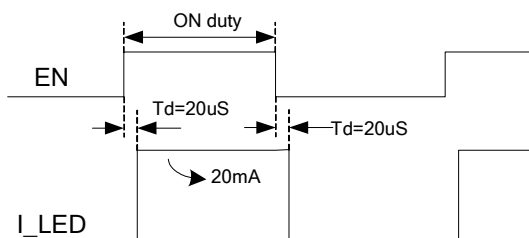

Fig. 5 PWM Dimming Control

EN dimming control

The LEDs' brightness can also be controlled by the pulses applied to the EN pin, Refer to the Fig. 6. Inside the device there is a 4-bit counter connecting to the EN pin. The LED

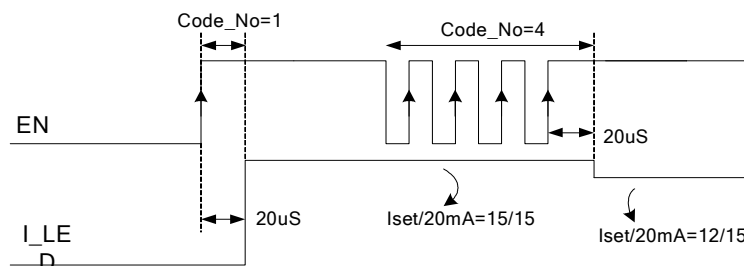

Fig. 6 Linear current Dimming Control

current can be programmed up to 16 levels depends on the number of rise edges of the input waveform. A high level input ("1") with pulse width wider than 20uS is regarded as a signal to stop the build-in counter. The time between two wide high levels (more than 20uS) is a counting period. When some rise edges occur between two high level pulses of 20us, the equation as shown below can calculate the active pulse number, called Code_No.

$$Code_No = Mod(N,16),$$

In the equation, N is the number of rise edges of the input waveform and mod function returns the remainder of N divided by 16. For example, if N=0, 16, or other integral multiple of 16, the mod function returns a value of 0, if N=1, 17 or other integral multiple of 16 plus 1, the mod function returns a value of 1, and so on.

The relationship between LEDs' brightness and the Code_No is listed as the following table.

Code No	I _{SET} /20mA	Code No	I _{SET} /20mA
0	0	8	8/15
1	1	9	7/15
2	14/15	10	6/15
3	13/15	11	5/15
4	12/15	12	4/15
5	11/15	13	3/15
6	10/15	14	2/15
7	9/15	15	1/15

The frequency of the input pulse should be lower than 100KHz, and the width of the high level and low level larger than 4uS to prevent false trigger.

Short Circuit Protection

If the voltage difference between Vout pin and any of a D pin exceeds 1V, for example, a LED is shorted in the circuit, the corresponding channel will be shutdown internally by the IC. Connect all unused LEDs to VOUT to avoid the accuracy reduction of the threshold of switching to 1.5X, and it also avoids wasting battery current.

If the Vout is shorted to ground, the BL8587 will stop operating and keep a constant source current of about 100mA until the short circuit is removed.

Thermal Protection

When the device temperature exceeds 150°C the driver enters a thermal protection shutdown mode. The IC resumes normal operation once the temperature drops by about 30°C to 120°C.

LED selection

LEDs with lower V_F are recommended. from the efficiency perspective. It keeps the driver in the 1X mode longer hence helps improve the efficiency and extends battery life. For example, a white LED with a V_F of 3.2V can keep the device working in the 1X mode for

lower supply voltage of 0.3V than a LED with V_F of 3.5V. For the BL8587, the LED with dropout lower than 3.4V is adequate.

External Component

The driver requires two external 1 μ F ceramic capacitors for decoupling input, output, and for the charge pump. Both capacitors type of X5R and X7R are recommended for the LED driver application. In charge pump modes, the input current ripple is kept minimal. An input bypass capacitor of 1 μ F is sufficient. In 1X mode, the device operates linearly and does not introduce switching noise to the supply.

Layout Consideration

Due to its high switching frequency and high transient current, careful consideration of PCB layout is necessary. The input capacitor (C_{IN}) and the device, as well as the ground of C_{IN} and C_{OUT} should be placed as close as possible. To achieve best performance, it is recommended to minimize the distance between components. Maximum trace width is recommended for connection. Make sure each device connects to immediate ground plane. The use of multiple via improves the package heat dissipation.

PACKAGE INFORMATION

Package	QFN3X3-16	Devices per reel	3000	Unit	mm