

High Temperature Silicon Carbide Power Schottky Diode

V_{RRM}	=	100 V
$I_F (T_C=25^\circ\text{C})$	=	4 A
Q_C	=	9 nC

Features

- 100 V Schottky rectifier
- 225 °C maximum operating temperature
- Zero reverse recovery charge
- Superior surge current capability
- Positive temperature coefficient of V_F
- Temperature independent switching behavior
- Lowest figure of merit Q_C/I_F
- Available screened to Mil-PRF-19500

Package

- RoHS Compliant

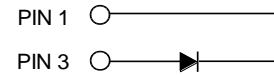

TO – 46

Advantages

- High temperature operation
- Improved circuit efficiency (Lower overall cost)
- Low switching losses
- Ease of paralleling devices without thermal runaway
- Smaller heat sink requirements
- Industry's lowest reverse recovery charge
- Industry's lowest device capacitance
- Ideal for output switching of power supplies
- Best in class reverse leakage current at operating temperature

Applications

- Down Hole Oil Drilling
- Geothermal Instrumentation
- Solenoid Actuators
- General Purpose High-Temperature Switching
- Amplifiers
- Solar Inverters
- Switched-Mode Power Supply (SMPS)
- Power Factor Correction (PFC)

Maximum Ratings at $T_j = 225^\circ\text{C}$, unless otherwise specified

Parameter	Symbol	Conditions	Values			Unit
			min.	typ.	max.	
Repetitive peak reverse voltage	V_{RRM}			100		V
Continuous forward current	I_F	$T_C = 25^\circ\text{C}$		4		A
Continuous forward current	I_F	$T_C \leq 225^\circ\text{C}$		2		A
RMS forward current	$I_{F(RMS)}$	$T_C \leq 225^\circ\text{C}$		4		A
Surge non-repetitive forward current, Half Sine Wave	$I_{F,SM}$	$T_C = 25^\circ\text{C}, t_p = 10\text{ ms}$		10		A
Non-repetitive peak forward current	$I_{F,max}$	$T_C = 25^\circ\text{C}, t_p = 10\ \mu\text{s}$		65		A
I^2t value	$\int i^2 dt$	$T_C = 25^\circ\text{C}, t_p = 10\text{ ms}$		0.5		A^2S
Power dissipation	P_{tot}	$T_C = 25^\circ\text{C}$		64		W
Operating and storage temperature	T_j, T_{stg}			-55 to 225		$^\circ\text{C}$

Electrical Characteristics at $T_j = 225^\circ\text{C}$, unless otherwise specified

Parameter	Symbol	Conditions	Values			Unit
			min.	typ.	max.	
Diode forward voltage	V_F	$I_F = 1\text{ A}, T_j = 25^\circ\text{C}$		1.6		V
		$I_F = 1\text{ A}, T_j = 225^\circ\text{C}$		2.6		
Reverse current	I_R	$V_R = 100\text{ V}, T_j = 25^\circ\text{C}$		1	5	μA
		$V_R = 100\text{ V}, T_j = 225^\circ\text{C}$		5	50	
Total capacitive charge	Q_C	$I_F \leq I_{F,MAX}$ $dI_F/dt = 200\text{ A}/\mu\text{s}$ $T_j = 210^\circ\text{C}$		9		nC
Switching time	t_s	$V_R = 100\text{ V}$		< 17		ns
Total capacitance	C	$V_R = 1\text{ V}, f = 1\text{ MHz}, T_j = 25^\circ\text{C}$		76		pF
		$V_R = 100\text{ V}, f = 1\text{ MHz}, T_j = 25^\circ\text{C}$		20		

Thermal Characteristics

Thermal resistance, junction - case	R_{thJC}	5.55	$^\circ\text{C}/\text{W}$
-------------------------------------	------------	------	---------------------------

Mechanical Properties

Mounting torque	M	0.6	Nm
-----------------	---	-----	----

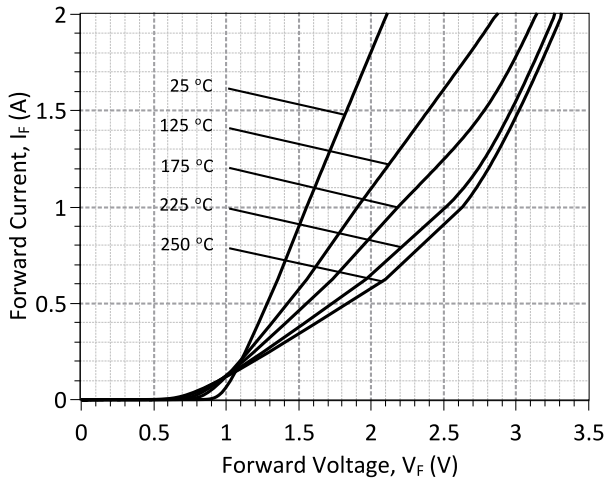

Figure 1: Typical Forward Characteristics

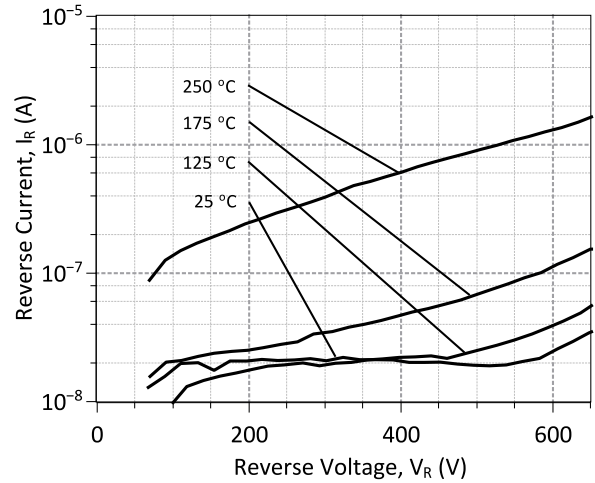

Figure 2: Typical Reverse Characteristics

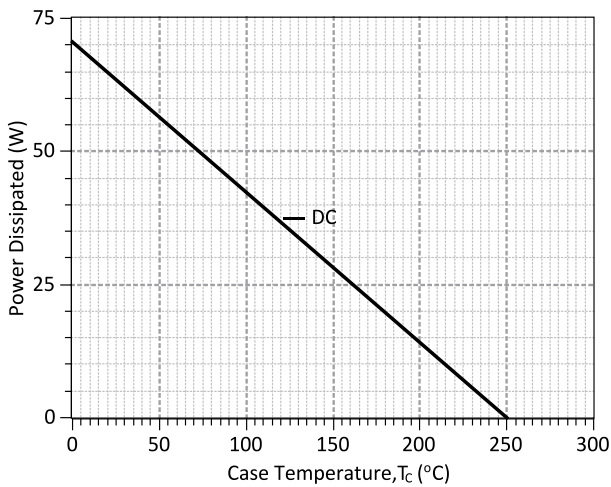
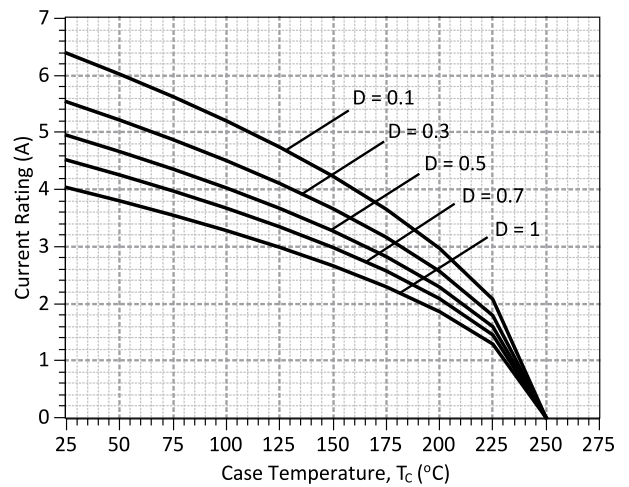

Figure 3: Power Derating Curve



**Figure 4: Current Derating Curves ($D = t_p/T$, $t_p = 400 \mu s$)
(Considering worst case Z_{th} conditions)**

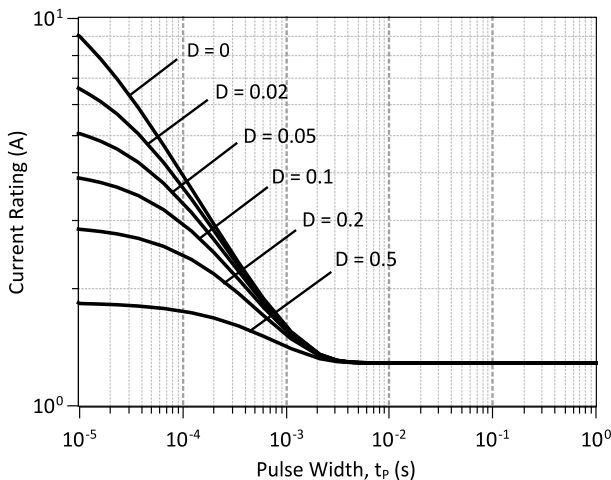

Figure 5: Current vs Pulse Duration Curves at $T_C = 225 \text{ }^\circ\text{C}$

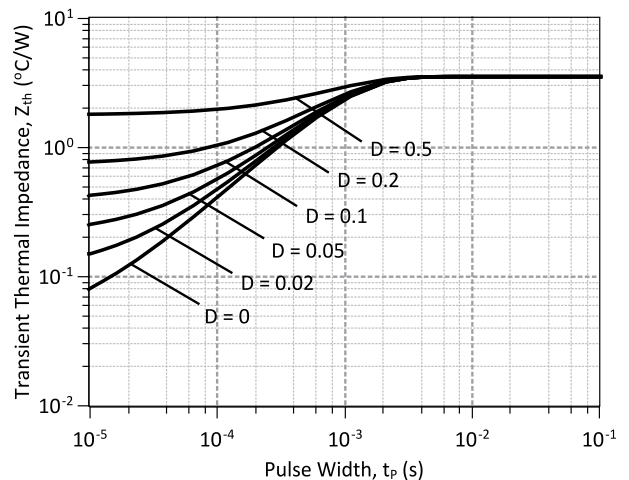
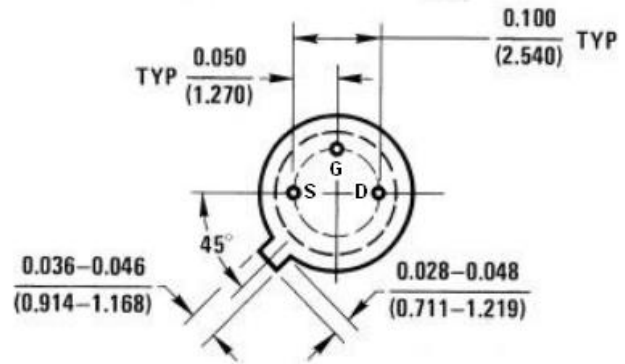
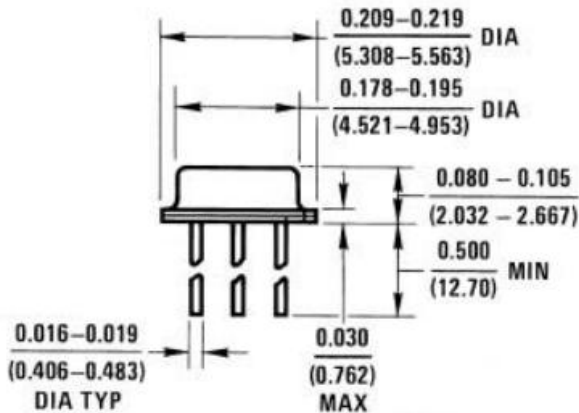

Figure 6: Transient Thermal Impedance

Package Dimensions:
TO-46
PACKAGE OUTLINE

NOTE

1. CONTROLLED DIMENSION IS INCH. DIMENSION IN BRACKET IS MILLIMETER.
2. DIMENSIONS DO NOT INCLUDE END FLASH, MOLD FLASH, MATERIAL PROTRUSIONS

Revision History

Date	Revision	Comments	Supersedes
2014/08/29	0	Initial release	

Published by
 GeneSiC Semiconductor, Inc.
 43670 Trade Center Place Suite 155
 Dulles, VA 20166

GeneSiC Semiconductor, Inc. reserves right to make changes to the product specifications and data in this document without notice.

GeneSiC disclaims all and any warranty and liability arising out of use or application of any product. No license, express or implied to any intellectual property rights is granted by this document.

Unless otherwise expressly indicated, GeneSiC products are not designed, tested or authorized for use in life-saving, medical, aircraft navigation, communication, air traffic control and weapons systems, nor in applications where their failure may result in death, personal injury and/or property damage.

SPICE Model Parameters

This is a secure document. Copy this code from the SPICE model PDF file on our website into a SPICE software program for simulation of the GB02SHT01-46.

```
*      MODEL OF GeneSiC Semiconductor Inc.
*
*      $Revision:   1.0           $
*      $Date:      29-AUG-2014   $
*
*      GeneSiC Semiconductor Inc.
*      43670 Trade Center Place Ste. 155
*      Dulles, VA 20166
*
*      COPYRIGHT (C) 2014 GeneSiC Semiconductor Inc.
*      ALL RIGHTS RESERVED
*
*      These models are provided "AS IS, WHERE IS, AND WITH NO WARRANTY
*      OF ANY KIND EITHER EXPRESSED OR IMPLIED, INCLUDING BUT NOT LIMITED
*      TO ANY IMPLIED WARRANTIES OF MERCHANTABILITY AND FITNESS FOR A
*      PARTICULAR PURPOSE."
*      Models accurate up to 2 times rated drain current.
*
*      Start of GB02SHT01-46 SPICE Model
*
.SUBCKT GB02SHT01ANODE KATHODE
D1 ANODE KATHODE GB02SHT01_25C; Call the Schottky Diode Model
D2 ANODE KATHODE GB02SHT01_PIN; Call the PiN Diode Model
.MODEL GB02SHT01_25C D
+ IS      3.57E-18      RS      0.49751
+ TRS1    0.0057      TRS2    2.40E-05
+ N       1           IKF     322
+ EG      1.2         XTI     3
+ CJO     9.12E-11    VJ      0.371817384
+ M       1.527759838 FC      0.5
+ TT      1.00E-10    BV      100
+ IBV     1.00E-03    VPK     100
+ IAVE    2           TYPE    SiC_Schottky
+ MFG     GeneSiC_Semiconductor
.MODEL GB02SHT01_PIN D
+ IS      5.73E-11    RS      0.72994
+ N       5           IKF     800
+ EG      3.23        XTI     -14
+ FC      0.5         TT      0
+ BV      100         IBV     1.00E-03
+ VPK     100         IAVE    2
+ TYPE    SiC_PiN
.ENDS
*
*      End of GB02SHT01 SPICE Model
```