

To our customers,

Old Company Name in Catalogs and Other Documents

On April 1st, 2010, NEC Electronics Corporation merged with Renesas Technology Corporation, and Renesas Electronics Corporation took over all the business of both companies. Therefore, although the old company name remains in this document, it is a valid Renesas Electronics document. We appreciate your understanding.

Renesas Electronics website: <http://www.renesas.com>

April 1st, 2010
Renesas Electronics Corporation

Issued by: Renesas Electronics Corporation (<http://www.renesas.com>)

Send any inquiries to <http://www.renesas.com/inquiry>.

Notice

1. All information included in this document is current as of the date this document is issued. Such information, however, is subject to change without any prior notice. Before purchasing or using any Renesas Electronics products listed herein, please confirm the latest product information with a Renesas Electronics sales office. Also, please pay regular and careful attention to additional and different information to be disclosed by Renesas Electronics such as that disclosed through our website.
2. Renesas Electronics does not assume any liability for infringement of patents, copyrights, or other intellectual property rights of third parties by or arising from the use of Renesas Electronics products or technical information described in this document. No license, express, implied or otherwise, is granted hereby under any patents, copyrights or other intellectual property rights of Renesas Electronics or others.
3. You should not alter, modify, copy, or otherwise misappropriate any Renesas Electronics product, whether in whole or in part.
4. Descriptions of circuits, software and other related information in this document are provided only to illustrate the operation of semiconductor products and application examples. You are fully responsible for the incorporation of these circuits, software, and information in the design of your equipment. Renesas Electronics assumes no responsibility for any losses incurred by you or third parties arising from the use of these circuits, software, or information.
5. When exporting the products or technology described in this document, you should comply with the applicable export control laws and regulations and follow the procedures required by such laws and regulations. You should not use Renesas Electronics products or the technology described in this document for any purpose relating to military applications or use by the military, including but not limited to the development of weapons of mass destruction. Renesas Electronics products and technology may not be used for or incorporated into any products or systems whose manufacture, use, or sale is prohibited under any applicable domestic or foreign laws or regulations.
6. Renesas Electronics has used reasonable care in preparing the information included in this document, but Renesas Electronics does not warrant that such information is error free. Renesas Electronics assumes no liability whatsoever for any damages incurred by you resulting from errors in or omissions from the information included herein.
7. Renesas Electronics products are classified according to the following three quality grades: “Standard”, “High Quality”, and “Specific”. The recommended applications for each Renesas Electronics product depends on the product’s quality grade, as indicated below. You must check the quality grade of each Renesas Electronics product before using it in a particular application. You may not use any Renesas Electronics product for any application categorized as “Specific” without the prior written consent of Renesas Electronics. Further, you may not use any Renesas Electronics product for any application for which it is not intended without the prior written consent of Renesas Electronics. Renesas Electronics shall not be in any way liable for any damages or losses incurred by you or third parties arising from the use of any Renesas Electronics product for an application categorized as “Specific” or for which the product is not intended where you have failed to obtain the prior written consent of Renesas Electronics. The quality grade of each Renesas Electronics product is “Standard” unless otherwise expressly specified in a Renesas Electronics data sheets or data books, etc.
 - “Standard”: Computers; office equipment; communications equipment; test and measurement equipment; audio and visual equipment; home electronic appliances; machine tools; personal electronic equipment; and industrial robots.
 - “High Quality”: Transportation equipment (automobiles, trains, ships, etc.); traffic control systems; anti-disaster systems; anti-crime systems; safety equipment; and medical equipment not specifically designed for life support.
 - “Specific”: Aircraft; aerospace equipment; submersible repeaters; nuclear reactor control systems; medical equipment or systems for life support (e.g. artificial life support devices or systems), surgical implantations, or healthcare intervention (e.g. excision, etc.), and any other applications or purposes that pose a direct threat to human life.
8. You should use the Renesas Electronics products described in this document within the range specified by Renesas Electronics, especially with respect to the maximum rating, operating supply voltage range, movement power voltage range, heat radiation characteristics, installation and other product characteristics. Renesas Electronics shall have no liability for malfunctions or damages arising out of the use of Renesas Electronics products beyond such specified ranges.
9. Although Renesas Electronics endeavors to improve the quality and reliability of its products, semiconductor products have specific characteristics such as the occurrence of failure at a certain rate and malfunctions under certain use conditions. Further, Renesas Electronics products are not subject to radiation resistance design. Please be sure to implement safety measures to guard them against the possibility of physical injury, and injury or damage caused by fire in the event of the failure of a Renesas Electronics product, such as safety design for hardware and software including but not limited to redundancy, fire control and malfunction prevention, appropriate treatment for aging degradation or any other appropriate measures. Because the evaluation of microcomputer software alone is very difficult, please evaluate the safety of the final products or system manufactured by you.
10. Please contact a Renesas Electronics sales office for details as to environmental matters such as the environmental compatibility of each Renesas Electronics product. Please use Renesas Electronics products in compliance with all applicable laws and regulations that regulate the inclusion or use of controlled substances, including without limitation, the EU RoHS Directive. Renesas Electronics assumes no liability for damages or losses occurring as a result of your noncompliance with applicable laws and regulations.
11. This document may not be reproduced or duplicated, in any form, in whole or in part, without prior written consent of Renesas Electronics.
12. Please contact a Renesas Electronics sales office if you have any questions regarding the information contained in this document or Renesas Electronics products, or if you have any other inquiries.

(Note 1) “Renesas Electronics” as used in this document means Renesas Electronics Corporation and also includes its majority-owned subsidiaries.

(Note 2) “Renesas Electronics product(s)” means any product developed or manufactured by or for Renesas Electronics.

8-ch level shift driver IC

DESCRIPTION

The μ PD160970 is a level shift driver IC for LTPS (low-temperature polysilicon) TFT-LCDs featuring a 2-level output function and incorporates eight on-chip level shifters. This IC realizes a 20 V MAX. withstanding voltage due to a high-withstanding-voltage CMOS process and has an output ON-resistance and switching characteristics ideal for TFT driving in LCD panels.

FEATURES

- High withstanding voltage : 20 V (MAX.)
- Supports low-voltage input (logic power supply voltage : 3.0 to 3.6 V)
- Includes 8 level shifters (among which 2 circuits can switch between normal and inverted output)
- Small thin package : 24-pin plastic TSSOP (5.72 mm (225))

ORDERING INFORMATION

Part Number	Package
μ PD160970MA-6A5	24-pin plastic TSSOP (5.72 mm (225))

The information contained in this document is being issued in advance of the production cycle for the product. The parameters for the product may change before final production or NEC Electronics Corporation, at its own discretion, may withdraw the product prior to its production. Not all products and/or types are available in every country. Please check with an NEC Electronics sales representative for availability and additional information.

1. BLOCK DIAGRAM / PIN CONFIGURATION

- 24-pin plastic TSSOP (5.72 mm (225))

μ PD160970MA-6A5

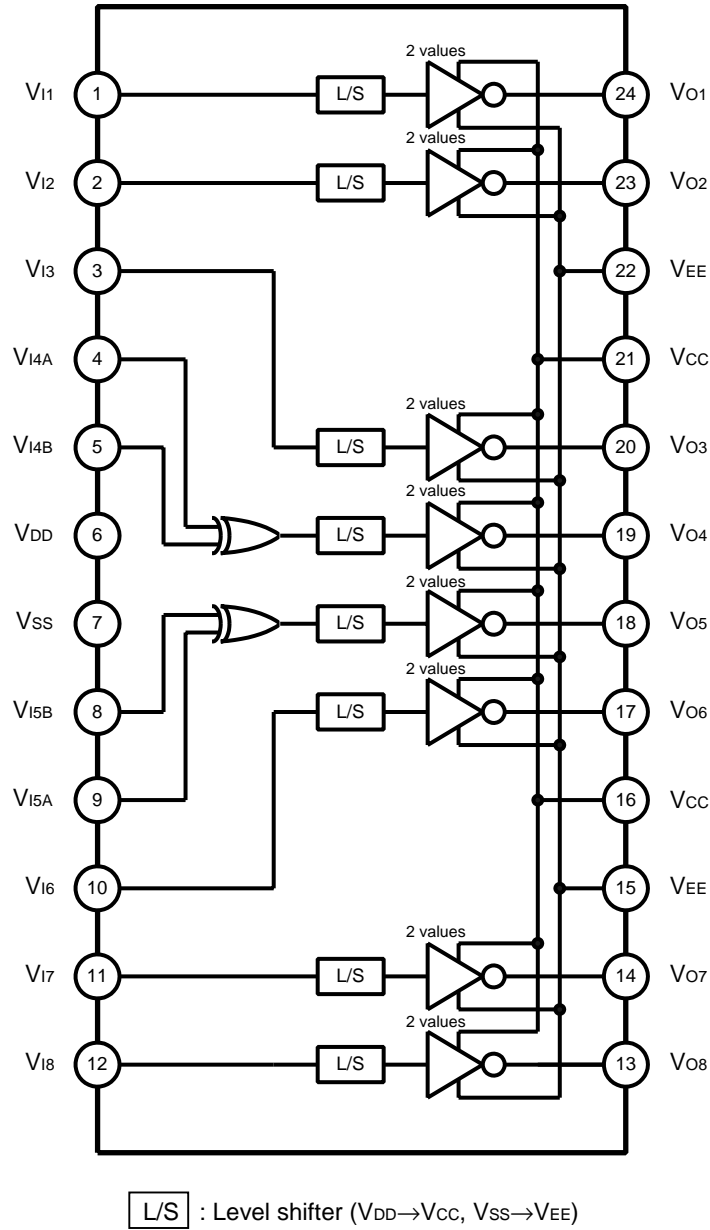

2. PIN FUNCTIONS

Pin Name	Pin Symbol	I/O	Function	Pin Name	Pin Symbol	I/O	Function		
V _{I1}	1	Input	Logic input	V _{O8}	13	Output	High-withstanding-voltage output		
V _{I2}	2			V _{O7}	14				
V _{I3}	3			V _{EE}	15	–	Negative power supply for high-withstanding-voltage block		
V _{I4A}	4			V _{CC}	16	–	Positive power supply for high-withstanding voltage block		
V _{I4B} ^{Note}	5			V _{O6}	17	Output	High-withstanding-voltage output		
V _{DD}	6	–	Power supply for logic block	V _{O5}	18				
V _{SS}	7	–	Logic ground	V _{O4}	19	Output	High-withstanding-voltage output		
V _{I5B} ^{Note}	8	Input	Logic input	V _{O3}	20				
V _{I5A}	9			V _{CC}	21			–	Negative power supply for high-withstanding-voltage block
V _{I6}	10			V _{EE}	22			–	Positive power supply for high-withstand-voltage block
V _{I7}	11			V _{O2}	23			Output	High-withstanding-voltage output
V _{I8}	12			V _{O1}	24				

Note Use the V_{I4B} and V_{I5B} pins at the DC level.

3. Relation of logic input and High-withstanding-voltage output

3.1 V_{I1} to V_{I3}, V_{I6} to V_{I8}

V _{In}	V _{On}
L	V _{CC}
H	V _{EE}

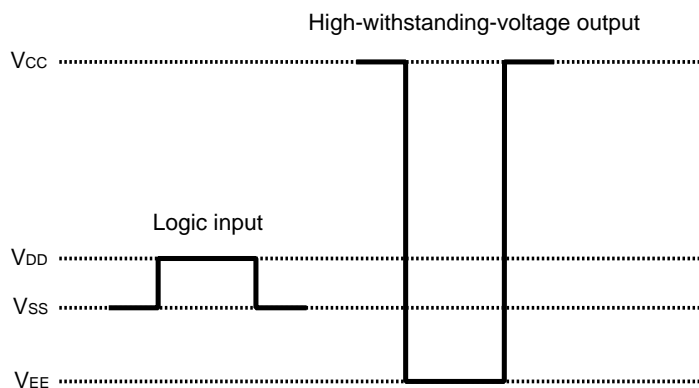

3.2 V_{I4A}/V_{I4B}, V_{I5A}/V_{I5B}

V _{InA}	V _{InB}	V _{On}
L	L (DC)	V _{CC}
H		V _{EE}
L	H (DC)	V _{EE}
H		V _{CC}

4. Usage Cautions

- (1) The power-on sequence is $V_{SS} \rightarrow V_{DD} \rightarrow$ logic signal $\rightarrow V_{EE} \rightarrow V_{CC}$, and the power-off sequence is the reverse sequence.
 - V_{SS} and V_{DD} , and V_{EE} and V_{CC} can be powered on simultaneously.
 - To prevent an abnormal output operation, it is recommended to fix the logic input during the transition phase of V_{EE} and V_{CC} to either "H" or "L".

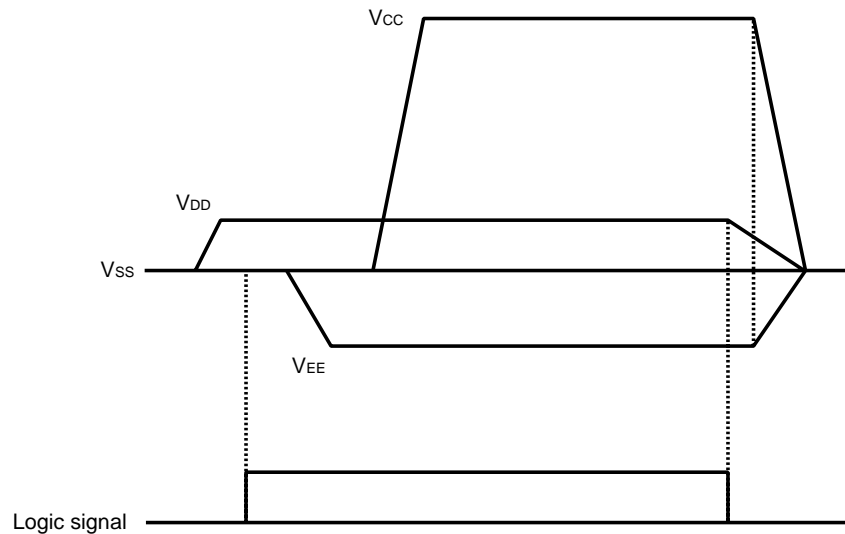

Remark The term "logic signal" as used above includes not only the rising edge/falling edge of the signal, but also "H" or "L" level input.

- (2) To ensure the switching characteristics of the V_{14A}/V_{14B} and V_{15A}/V_{15B} signal input, be sure to make the V_{14B} and V_{15B} pins DC input. Also, be sure to fix unused input pins to "H" or "L".
- (3) Perform thorough evaluation with the actual device for simultaneous switching of multiple output circuits, bearing in mind the allowable output current during switching.
- (4) The output transistors in this device are designed for an impedance of several tens of ohms. Therefore, if driving a large load, IC malfunction and IC destruction or degradation may result owing to the influence of an output current of several hundred mA_{p-p} per output. To prevent such malfunction from occurring, a number of countermeasures can be implemented, including the following.
 - <1> Use a large-capacitance decoupling capacitor with superior high-frequency characteristics.
 - <2> Insert in series a damping resistor for limiting the output current between the output pin and the load.

Since the optimum values of constants differ depending on the equipment, determine the correct constants based on careful evaluation.
- (5) Be sure to externally short power-supply pins for which several exist (V_{CC} and V_{EE}).
- (6) Do not use the device with multiple output pins shorted. This may cause IC malfunction, destruction, or degradation.

5. ELECTRICAL SPECIFICATIONS

Absolute Maximum Ratings (T_A = 25°C, V_{SS} = 0 V)

Parameter	Symbol	Rating	Unit
Logic Part Supply Voltage	V _{DD}	-0.5 to +4.5	V
Positive power supply for high-withstanding-voltage block	V _{CC}	-0.5 to +17.0	V
Negative power supply for high-withstanding-voltage block	V _{EE}	-8.0 to +0.5	V
Bias power supply for high-withstanding-voltage block	V _{CC} -V _{EE}	-0.5 to +25.0	V
Input Voltage	V _I	-0.5 to V _{DD} + 0.5	V
Output Voltage	V _O	V _{EE} - 0.5 to V _{CC} + 0.5	V
Operating Ambient Temperature	T _A	-10 to +60	°C
Storage Temperature	T _{stg}	-40 to +125	°C
Power Dissipation	P _d	500 ^{Note}	mW

Note When a glass epoxy board (100 mm x 100 mm x 1.0 mm, copper-plated area of 15%) is mounted.

Caution Product quality may suffer if the absolute maximum rating is exceeded even momentarily for any parameter. That is, the absolute maximum ratings are rated values at which the product is on the verge of suffering physical damage, and therefore the product must be used under conditions that ensure that the absolute maximum ratings are not exceeded.

Recommended Operating Range (T_A = -10 to +60°C, V_{SS} = 0 V)

Parameter	Symbol	Conditions	MIN.	TYP.	MAX.	Unit
Supply Voltage	V _{DD}		3.0	3.3	3.6	V
	V _{CC}		9.5	11.5	13.5	V
	V _{EE}		-6.5	-5.5	-4.5	V
	V _{CC} -V _{EE}		14.0	17.0	20.0	V
Clock Frequency	f _{CLK}			200	kHz	

Electrical Characteristics (T_A = -10 to +60°C, V_{DD} = 3.3 V ± 0.3 V, V_{SS} = 0 V, V_{CC} = 11.5 V ± 1.0 V, V_{EE} = -5.5 V ± 0.5 V, t_r = t_r ≤ 5.0 ns)

Parameter	Symbol	Conditions	MIN.	TYP. ^{Note}	MAX.	Unit
Low-Level Input Voltage	V _{IL}	All input pins	V _{SS}		0.2 V _{DD}	V
High-Level Input Voltage	V _{IH}	All input pins	0.7 V _{DD}		V _{DD}	V
Low-Level Output Voltage	V _{OL}	I _{OL} = +1.0 mA, All output pins		-5.42	-4.87	V
High-Level Output Voltage	V _{OH}	I _{OH} = -1.0 mA, All output pins	10.37	11.42		V
Output ON Resistance	R _{ON}	I _O = ±1.0 mA, All output pins		80	130	Ω
Static Current	I _{DD}	V _I = V _{SS} no load	V _{DD}	0.1	10	μA
	I _{CC}		V _{CC}	0.1	10	μA
Input Leak Current	I _{IL}	V _I = V _{DD} or V _{SS} , All input pins	-1.0		1.0	μA
★ Input Capacitance	C _I			7		pF

Note The TYP. value is a reference value when T_A = 25°C, V_{DD} = 3.3 V, V_{CC} = 11.5 V, V_{EE} = -5.5 V.

Switching Characteristics ($T_A = -10$ to $+60^\circ\text{C}$, $V_{DD} = 3.3\text{ V} \pm 0.3\text{ V}$, $V_{SS} = 0\text{ V}$, $V_{CC} = 11.5\text{ V} \pm 1.0\text{ V}$, $V_{EE} = -5.5\text{ V} \pm 0.5\text{ V}$, $t_r = t_f \leq 5.0\text{ ns}$)

Parameter	Symbol	Condition	MIN.	TYP. ^{Note}	MAX.	Unit
Output delay time1	t _{PHL1}	All output pins, no load,		35	140	ns
	t _{PLH1}	V _{O1} -V _{O3} , V _{O6} -V _{O8}		45	140	ns
Output delay time2	t _{PHL2}	All output pins, no load,		40	140	ns
	t _{PLH2}	V _{O4} , V _{O5}		50	140	ns

Note The TYP. value is a reference value when $T_A = 25^\circ\text{C}$, $V_{DD} = 3.3\text{ V}$, $V_{CC} = 11.5\text{ V}$, $V_{EE} = -5.5\text{ V}$.

Switching Characteristics Waveform

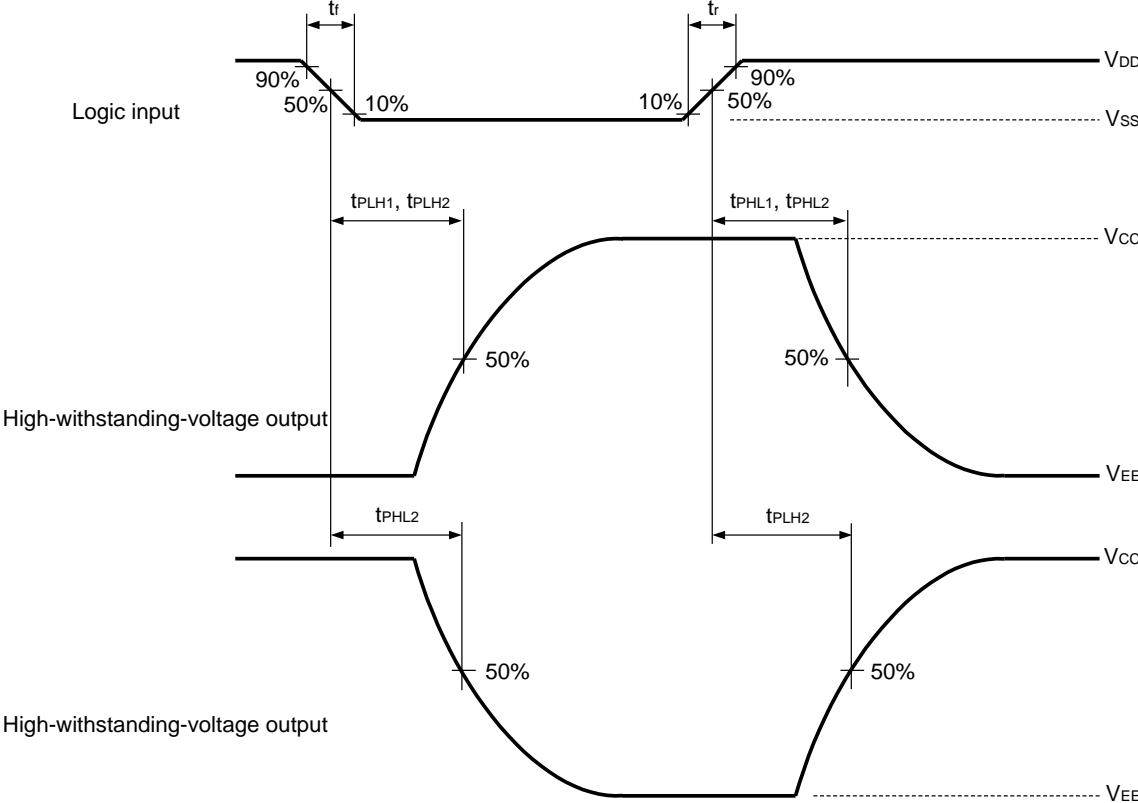

6. PACKAGE DRAWING

24-PIN PLASTIC TSSOP (5.72 mm (225))

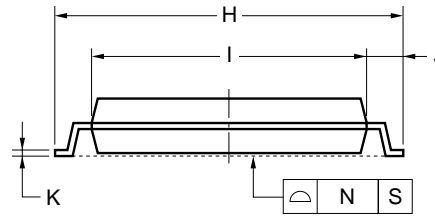
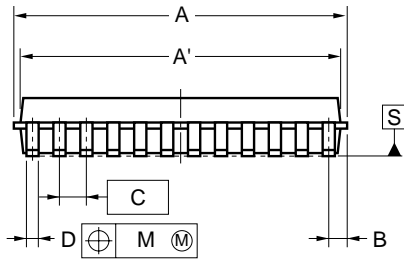
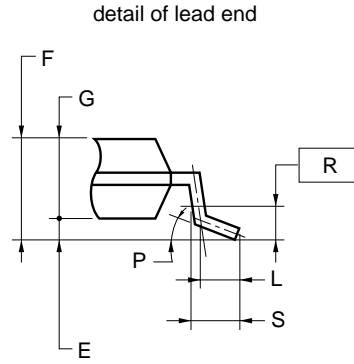
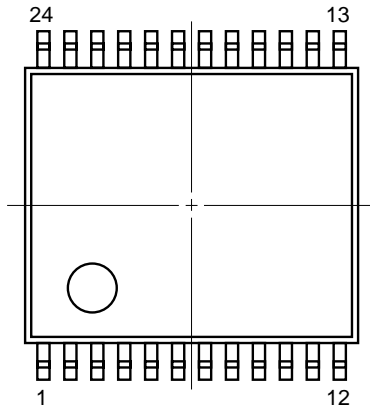

NOTE

Each lead centerline is located within 0.10 mm of its true position (T.P.) at maximum material condition.

ITEM	MILLIMETERS
A	6.65±0.10
A'	6.5±0.1
B	0.575
C	0.5 (T.P.)
D	0.22±0.05
E	0.1±0.05
F	1.2 MAX.
G	1.0±0.05
H	6.4±0.1
I	4.4±0.1
J	1.0±0.1
K	0.17±0.025
L	0.5
M	0.10
N	0.08
P	3° ^{+5°} -3°
R	0.25
S	0.6±0.15

P24MA-50-6A5

7. RECOMMENDED MOUNTING CONDITIONS

The μ PD160970 should be soldered and mounted under the following recommended conditions.

For details of the recommended soldering conditions, refer to the document **Semiconductor Device Mounting Technology Manual (C10535E)**.

For soldering methods and conditions other than those recommended below, contact an NEC Electronics sales representative.

Recommended Soldering Conditions for Surface Mounting Type

μ PD160970MA-6A5 : 24-pin plastic TSSOP (5.72 mm (225))

Soldering Method	Soldering Conditions	Recommended Condition Symbol
Infrared reflow	Package peak temperature : 235°C, Time : 30 seconds max. (at 210°C or higher), Count : Three times or less, Exposure, limit : None, Flux : Rosin flux with low chlorine (0.2 Wt% or below) recommended	IR35-00-3
VPS	Package peak temperature : 215°C, Time : 40 seconds max. (at 200°C or higher), Count : Three times or less, Exposure, limit : None, Flux : Rosin flux with low chlorine (0.2 Wt% or below) recommended	VP15-00-3
Wave Soldering	Package peak temperature : 260°C, Time : 10 seconds max., Preheating temperature : 120°C max., Exposure, limit : Once, Flux : Rosin flux with low chlorine (0.2 Wt% or below) recommended	WS60-00-1

Caution Do not use different soldering methods together.

[MEMO]

NOTES FOR CMOS DEVICES**① PRECAUTION AGAINST ESD FOR SEMICONDUCTORS**

Note:

Strong electric field, when exposed to a MOS device, can cause destruction of the gate oxide and ultimately degrade the device operation. Steps must be taken to stop generation of static electricity as much as possible, and quickly dissipate it once, when it has occurred. Environmental control must be adequate. When it is dry, humidifier should be used. It is recommended to avoid using insulators that easily build static electricity. Semiconductor devices must be stored and transported in an anti-static container, static shielding bag or conductive material. All test and measurement tools including work bench and floor should be grounded. The operator should be grounded using wrist strap. Semiconductor devices must not be touched with bare hands. Similar precautions need to be taken for PW boards with semiconductor devices on it.

② HANDLING OF UNUSED INPUT PINS FOR CMOS

Note:

No connection for CMOS device inputs can be cause of malfunction. If no connection is provided to the input pins, it is possible that an internal input level may be generated due to noise, etc., hence causing malfunction. CMOS devices behave differently than Bipolar or NMOS devices. Input levels of CMOS devices must be fixed high or low by using a pull-up or pull-down circuitry. Each unused pin should be connected to V_{DD} or GND with a resistor, if it is considered to have a possibility of being an output pin. All handling related to the unused pins must be judged device by device and related specifications governing the devices.

③ STATUS BEFORE INITIALIZATION OF MOS DEVICES

Note:

Power-on does not necessarily define initial status of MOS device. Production process of MOS does not define the initial operation status of the device. Immediately after the power source is turned ON, the devices with reset function have not yet been initialized. Hence, power-on does not guarantee out-pin levels, I/O settings or contents of registers. Device is not initialized until the reset signal is received. Reset operation must be executed immediately after power-on for devices having reset function.

Reference Documents**NEC Semiconductor Device Reliability/Quality Control System (C10983E)****Quality Grades On NEC Semiconductor Devices (C11531E)**

- **The information contained in this document is being issued in advance of the production cycle for the product. The parameters for the product may change before final production or NEC Electronics Corporation, at its own discretion, may withdraw the product prior to its production.**
- **Not all products and/or types are available in every country. Please check with an NEC Electronics sales representative for availability and additional information.**
- No part of this document may be copied or reproduced in any form or by any means without the prior written consent of NEC Electronics. NEC Electronics assumes no responsibility for any errors that may appear in this document.
- NEC Electronics does not assume any liability for infringement of patents, copyrights or other intellectual property rights of third parties by or arising from the use of NEC Electronics products listed in this document or any other liability arising from the use of such products. No license, express, implied or otherwise, is granted under any patents, copyrights or other intellectual property rights of NEC Electronics or others.
- Descriptions of circuits, software and other related information in this document are provided for illustrative purposes in semiconductor product operation and application examples. The incorporation of these circuits, software and information in the design of a customer's equipment shall be done under the full responsibility of the customer. NEC Electronics assumes no responsibility for any losses incurred by customers or third parties arising from the use of these circuits, software and information.
- While NEC Electronics endeavors to enhance the quality, reliability and safety of NEC Electronics products, customers agree and acknowledge that the possibility of defects thereof cannot be eliminated entirely. To minimize risks of damage to property or injury (including death) to persons arising from defects in NEC Electronics products, customers must incorporate sufficient safety measures in their design, such as redundancy, fire-containment and anti-failure features.
- NEC Electronics products are classified into the following three quality grades: "Standard", "Special" and "Specific". The "Specific" quality grade applies only to NEC Electronics products developed based on a customer-designated "quality assurance program" for a specific application. The recommended applications of an NEC Electronics products depend on its quality grade, as indicated below. Customers must check the quality grade of each NEC Electronics product before using it in a particular application.
 - "Standard": Computers, office equipment, communications equipment, test and measurement equipment, audio and visual equipment, home electronic appliances, machine tools, personal electronic equipment and industrial robots.
 - "Special": Transportation equipment (automobiles, trains, ships, etc.), traffic control systems, anti-disaster systems, anti-crime systems, safety equipment and medical equipment (not specifically designed for life support).
 - "Specific": Aircraft, aerospace equipment, submersible repeaters, nuclear reactor control systems, life support systems and medical equipment for life support, etc.

The quality grade of NEC Electronics products is "Standard" unless otherwise expressly specified in NEC Electronics data sheets or data books, etc. If customers wish to use NEC Electronics products in applications not intended by NEC Electronics, they must contact an NEC Electronics sales representative in advance to determine NEC Electronics' willingness to support a given application.

(Note)

- (1) "NEC Electronics" as used in this statement means NEC Electronics Corporation and also includes its majority-owned subsidiaries.
- (2) "NEC Electronics products" means any product developed or manufactured by or for NEC Electronics (as defined above).