

Samurai-6M/MX

6 Port 10/100 Mbit/s Single Chip Ethernet Switch Controller (ADM6996MX - Green Package Version)

ADM6996M/MX, Version AC

Communications



Never stop thinking

Edition 2005-11-25

**Published by Infineon Technologies AG,
St.-Martin-Strasse 53,
81669 München, Germany**

**© Infineon Technologies AG 2005.
All Rights Reserved.**

Attention please!

The information herein is given to describe certain components and shall not be considered as a guarantee of characteristics.

Terms of delivery and rights to technical change reserved.

We hereby disclaim any and all warranties, including but not limited to warranties of non-infringement, regarding circuits, descriptions and charts stated herein.

Information

For further information on technology, delivery terms and conditions and prices please contact your nearest Infineon Technologies Office (www.infineon.com).

Warnings

Due to technical requirements components may contain dangerous substances. For information on the types in question please contact your nearest Infineon Technologies Office.

Infineon Technologies Components may only be used in life-support devices or systems with the express written approval of Infineon Technologies, if a failure of such components can reasonably be expected to cause the failure of that life-support device or system, or to affect the safety or effectiveness of that device or system. Life support devices or systems are intended to be implanted in the human body, or to support and/or maintain and sustain and/or protect human life. If they fail, it is reasonable to assume that the health of the user or other persons may be endangered.

ADM6996M/MX, 6 Port 10/100 Mbit/s Single Chip Ethernet Switch Controller (ADM6996MX - Green Package Version)**Revision History: 2005-11-25, Rev. 1.31****Previous Version: Rev. 1.23**

Page/Date	Subjects (major changes since last revision)
Page 15	Rev. 1.2: Modify analog pins number (RXP4-0, RXN4-0, TXP4-0 and TXN4-0)
Page 81-82	Rev. 1.21: Rearrange 0E _H and 0F _H registers map
Page 22	Rev. 1.22: Modify LNKFP5 pin description/1 _B , Link Failed
2005-07-04	Changed to the new Infineon format
2005-07-04	Rev. 1.22 changed to Rev. 1.23
2005-08-23	Rev 1.3: Update in content
2005-11-01	Revision 1.3 changed to Revision 1.31 Minor change. Included Green package information

Trademarks

ABM[®], ACE[®], AOP[®], ARCOFI[®], ASM[®], ASP[®], DigiTape[®], DuSLIC[®], EPIC[®], ELIC[®], FALC[®], GEMINAX[®], IDEC[®], INCA[®], IOM[®], IPAT[®]-2, ISAC[®], ITAC[®], IWE[®], IWORX[®], MUSAC[®], MuSLIC[®], OCTAT[®], OptiPort[®], POTSWIRE[®], QUAT[®], QuadFALC[®], SCOUT[®], SICAT[®], SICOFI[®], SIDEC[®], SLICOFI[®], SMINT[®], SOCRATES[®], VINETIC[®], 10BaseV[®], 10BaseVX[®] are registered trademarks of Infineon Technologies AG. 10BaseS[™], EasyPort[™], VDSLite[™] are trademarks of Infineon Technologies AG. Microsoft[®] is a registered trademark of Microsoft Corporation, Linux[®] of Linus Torvalds, Visio[®] of Visio Corporation, and FrameMaker[®] of Adobe Systems Incorporated.

Table of Contents

	Table of Contents	4
	List of Figures	7
	List of Tables	8
1	Product Overview	10
1.1	Samurai-6M/6MX (ADM6996M/MX) Overview	10
1.2	Features	10
1.3	Applications	11
1.4	Block Diagram	12
1.5	Data Lengths	12
2	Interface Description	13
2.1	Pin Diagram	13
2.2	Abbreviations	14
2.3	Pin Description by Function	14
3	Function Description	29
3.1	Switch Functional Description	29
3.1.1	Basic Operation	29
3.1.2	Buffers and Queues	29
3.1.3	Full Duplex Flow Control	29
3.1.4	Half Duplex Flow Control	29
3.1.5	Back-Off Algorithm	29
3.1.6	Inter-Packet Gap (IPG)	30
3.1.7	Trunking Function	30
3.1.8	Illegal Frames	30
3.1.9	Broadcast Storm	30
3.1.10	Bandwidth Control	31
3.1.11	Smart Discard	31
3.1.12	LED Display	31
3.1.12.1	Single Color LED Display	32
3.1.12.2	Dual Color LED Display	34
3.1.12.3	Circuit for Single LED Mode	34
3.1.12.4	Circuit for Dual LED Mode	35
3.1.13	Packet Identification	35
3.1.13.1	Span Packet	36
3.1.13.2	Management Packet	36
3.1.13.3	Cross_VLAN Packet	37
3.1.14	Tagged VLAN or Port VLAN	38
3.1.14.1	VLAN Filters	38
3.1.14.2	Port VLAN	38
3.1.14.3	Tagged VLAN	38
3.1.14.4	VID for Comparison and Carried through Samurai-6M/6MX (ADM6996M/MX)	38
3.1.14.5	Admit Only VLAN-Tagged Packets	39
3.1.14.6	VID Check	39
3.1.14.7	FID and VLAN Boundary	39
3.1.14.8	Ingress Filter	40
3.1.14.9	VLAN Violation	40
3.1.14.10	TXTAG Carried through Samurai-6M/6MX (ADM6996M/MX)	40
3.1.14.11	Tagged Member Carried through Samurai-6M/6MX (ADM6996M/MX)	40

3.1.14.12	Egress Tag Rule	41
3.1.14.13	Tagged PRI Carried through Samurai-6M/6MX (ADM6996M/MX)	42
3.1.14.14	CFI Carried through Samurai-6M/6MX (ADM6996M/MX)	43
3.1.14.15	Egress TAG	43
3.1.15	Priority Queue	43
3.1.15.1	System PRI	44
3.1.15.2	Queue Assigned	44
3.1.15.3	Configure Samurai QoS Function	46
3.1.16	Address Learning	46
3.1.16.1	Dynamic Learning	47
3.1.16.2	Manual Learning	47
3.1.16.3	Learning Table	47
3.1.16.3.1	Entry Format in the Learning Table	47
3.1.16.3.2	The Registers Accessing the Learning Table	48
3.1.16.3.3	Rules to Access the Learning Table	50
3.1.16.3.4	Example	51
3.1.17	Address Aging	51
3.1.18	Hardware Based IGMP Snooping	51
3.1.18.1	Entry Format of IGMP Membership Table	52
3.1.18.2	The Registers Accessing the IGMP Membership Table	52
3.1.18.3	IGMP Snooping Introduction	53
3.1.19	Source Violation	56
3.1.20	Packet Forwarding	58
3.1.20.1	Control Table	58
3.1.20.2	Default Output Ports	58
3.1.20.3	Forwarding Algorithm	58
3.1.21	802.1x Security Function	59
3.1.22	Special TAG	61
3.1.22.1	Special Tag for the Receive	61
3.1.22.2	Special Tag for the Transmit	63
3.2	Port4 and Port5 MII Connection	65
3.3	10/100M PHY Block	71
3.3.1	Auto Negotiation	72
3.3.2	Speed/Duplex Configuration	72
3.4	Hardware, EEPROM and SMI Interface for Configuration	73
3.4.1	Hardware Setting	73
3.4.2	EEPROM Interface	74
3.4.3	SMI Interface	78
3.5	The Hardware Difference between ADM6996M/MX and ADM6996F	80
4	Registers Description	81
4.1	EEPROM Basic Registers	91
4.2	EEPROM Extended Registers	137
4.3	Counter and Switch Status Registers	158
4.4	PHY Registers	180
5	Electrical Specification	191
5.1	TX/FX Interface	191
5.1.1	TP Interface	191
5.1.2	FX Interface	192
5.2	DC Characterization	192
5.3	AC Characterization	194

5.3.1	XTAL/OSC Timing	194
5.3.2	Power On Reset	195
5.3.3	EEPROM Interface Timing	195
5.3.4	10Base-TX MII Input Timing	196
5.3.5	10Base-TX MII Output Timing	197
5.3.6	100Base-TX MII Input Timing	198
5.3.7	100Base-TX MII Output Timing	199
5.3.8	RMII REFCLK Input Timing	199
5.3.9	RMII REFCLK Output Timing	200
5.3.10	Reduce MII Timing	201
5.3.11	GPSI (7-wire) Input Timing	202
5.3.12	GPSI (7-wire) Output Timing	203
5.3.13	SDC/SDIO Timing	203
5.3.14	MDC/MDIO Timing	204
6	Package Outlines	205
6.1	Package Information	205
	Terminology	206

List of Figures

Figure 1	Samurai-6M/6MX (ADM6996M/MX) Block Diagram.	12
Figure 2	4 TP/FX PORT + 2 MII PORT 128 Pin Diagram.	13
Figure 3	Circuit for Single Color LED Mode	34
Figure 4	Circuit for Dual Color LED Mode	35
Figure 5	To Configure Samurai QoS function.	46
Figure 6	Flow chart of 802.1x Security Function.	60
Figure 7	ADM6996M/MX to CPU with single MII Connection.	65
Figure 8	The configurations of the implementation by ADM6996M/MX Special TAG functions.	66
Figure 9	Software Operation.	67
Figure 10	ADM6996M/MX to CPU with dual MII Connection	69
Figure 11	100M Full duplex MAC to MAC MII Connection	70
Figure 12	PCS to MAC MII connection.	71
Figure 13	Interconnection between Samurai-6M/6MX (ADM6996M/MX), EEPROM and CPU	73
Figure 14	The Power-On-Sequence of Samurai.	76
Figure 15	Timing Diagram of RC, EECS and EESK (with correct signature EEPROM).	77
Figure 16	Timing Diagram of RC, EECS and EESK (without EEPROM)	78
Figure 17	SMI Interface	79
Figure 18	TP Interface	191
Figure 19	FX Interface	192
Figure 20	XTAL/OSC Timing	194
Figure 21	Power On Reset Timing	195
Figure 22	EEPROM Interface Timing	195
Figure 23	10Base-TX MII Input Timing.	196
Figure 24	10Base-TX MII Output Timing	197
Figure 25	100Base-TX MII Input Timing.	198
Figure 26	100Base-TX MII Output Timing	199
Figure 27	RMII REFCLK Input Timing	199
Figure 28	RMII REFCLK Output Timing	200
Figure 29	Reduce MII Timing (1 of 2).	201
Figure 30	Reduce MII Timing (2 of 2).	201
Figure 31	GPSI (7-wire) Input Timing	202
Figure 32	GPSI (7-wire) Output Timing	203
Figure 33	SDC/SDIO Timing.	203
Figure 34	MDC/MDIO Timing	204
Figure 35	P-PQFP-128 Outside Dimension	205

List of Tables

Table 1	Abbreviations for Pin Type	14
Table 2	Abbreviations for Buffer Type	14
Table 3	IO Signals	15
Table 4	Smart Discard	31
Table 5	Discard Ratio	31
Table 6	Single Color LED Display	32
Table 7	Dual Color LED Display	34
Table 8	Packet Identification	35
Table 9	Packet Identification Groups	36
Table 10	Span Packet	36
Table 11	Management Packet	37
Table 12	Cross_VLAN Packet	37
Table 13	VLAN Filters	38
Table 14	VID Comparison	39
Table 15	FID Search Algorithm	39
Table 16	VLAN Boundary Search Algorithm	39
Table 17	TXTAG Carried through Samurai-6M/6MX (ADM6996M/MX)	40
Table 18	Egress Tag Result	41
Table 19	Tagged PRI Carried	42
Table 20	CFI Carried	43
Table 21	Priority Queue	44
Table 22	Queue Assigned	44
Table 23	Control Register Description for Accessing the Address Table	48
Table 24	Description for Command and Access Control	49
Table 25	Status Register Description	49
Table 26	Description for the Status Register	49
Table 27	Control Register Description for Accessing the IGMP Membership Table	52
Table 28	Description for Command and Access Control	53
Table 29	Entry Format of IGMP Membership Table	53
Table 30	IPV4/IGMP/General Query	53
Table 31	IPV4/IGMP/V1 Report	54
Table 32	IPV4/IGMP/General Query	54
Table 33	IPV4/IGMP/V1 Report	54
Table 34	IPV4/IGMP/V2 Report	54
Table 35	IPV4/IGMP/V2 Leave	55
Table 36	IPV4/IGMP/Group-Specific Query	55
Table 37	IGMP Membership Table	56
Table 38	Forwarding Algorithm	58
Table 39	Special Tag for the Receive	61
Table 40	Option for Special Tag Transmit	63
Table 41	Special Tag for the Transmit	64
Table 42	Special Tag	65
Table 43	Set WAN/LAN Group	66
Table 44	Packets Identified by ADM6996M/MX	67
Table 45	Speed/Duplex Configuration	73
Table 46	Hardware Setting	74
Table 47	(D) The Pin Type of EECS, EESK, EDI and EDO during the Operation	79
Table 48	Memory Map	80
Table 49	Pin Description(QFP128)	80

List of Tables

Table 50	Registers Address Space	81
Table 51	Registers Overview	81
Table 52	Register Access Types	90
Table 53	Registers Clock Domains	90
Table 54	P1~P5 Basic Control Registers	93
Table 55	Px_EC Registers	94
Table 56	PxSO Registers	107
Table 57	VFxL Registers	137
Table 58	VFxH Registers	138
Table 59	TFx Registers	139
Table 60	PFx Registers	140
Table 61	RAx Registers	149
Table 62	TUFx Registers	150
Table 63	CLx Registers	162
Table 64	CHx Registers	164
Table 65	PHY_Cx Registers	181
Table 66	PHY_Sx Registers	183
Table 67	PHY_Ix_A Registers	184
Table 68	PHY_Ix_B Registers	184
Table 69	ANAPx Registers	186
Table 70	ANLPAx Registers	187
Table 71	ANEx Registers	188
Table 72	NPTx Registers	189
Table 73	LPNPx Registers	190
Table 74	Power Consumption	192
Table 75	Absolute Maximum Ratings	193
Table 76	Recommended Operating Conditions	193
Table 77	DC Electrical Characteristics for 3.3 V Operation	194
Table 78	XTAL/OSC Timing	194
Table 91	Under $V_{CC30} = 2.97V \sim 3.63 V, T_j = 0^\circ C \sim 115^\circ C$	194
Table 79	Power On Reset Timing	195
Table 80	EEPROM Interface Timing	195
Table 81	10Base-TX MII Input Timing	196
Table 82	10-Base-TX MII Output Timing	197
Table 83	100Base-TX MII Input Timing	198
Table 84	100Base-TX MII Output Timing	199
Table 85	RMII REFCLK Input Timing	200
Table 86	RMII REFCLK Output Timing	200
Table 87	Reduce MII Timing	201
Table 88	GPSI (7-wire) Input Timing	202
Table 89	GPSI (7-wire) Output Timing	203
Table 90	SDC/SDIO Timing	204
Table 91	MDC/MDIO Timing	204

1 Product Overview

1.1 Samurai-6M/6MX (ADM6996M/MX) Overview

The Samurai-6M/6MX (ADM6996M/MX) is a high performance, low cost, highly integrated (Controller, PHY and Memory) 6-port MII MAC ports with five supporting 10/100 Mbit/s PHY TX/FX Ethernet Full/Half duplex operation. The Samurai-6M/6MX (ADM6996M/MX) is intended for applications such as stand alone bridges for the low cost SOHO markets such as 5-port switches and router applications. The Samurai-6MX (ADM6996MX) is the environmentally friendly "green" package version.

The Samurai-6M/6MX (ADM6996M/MX) provides functions such as: 802.1p(Q.O.S.), 802.1Q(VLAN), Port MAC address locking, management, port status, TP auto-MDIX, 25M crystal & extra MII port functions to meet customer requests on switch demand.

The Samurai-6M/6MX (ADM6996M/MX) also supports back pressure in Half-Duplex mode and the 802.3x Flow Control Pause packet in Full-Duplex mode to prevent packet loss when buffers are full. When Back Pressure is enabled, and there is no receive buffer available for the incoming packet, the Samurai-6M/6MX (ADM6996M/MX) will issue a JAM pattern on the receiving port in Half Duplex mode and issue the 802.3x Pause packet back to the receiving end in Full Duplex mode.

The built-in SRAM used for the packet buffer is divided into 256 bytes per block to achieve the optimized memory utilization through complicated link lists on packets with various lengths.

The Samurai-6M/6MX (ADM6996M/MX) also supports priority features using Port-Based, VLAN and IP TOS field checking. Users can easily set different priority modes in individual ports, through a small low-cost micro controller when initializing or configuring on-the-fly. Each output port supports four queues in the way of fixed N: 1 fairness queuing to fit the bandwidth demand on various types of packets such as Voice, Video and Data. 802.1Q, Tag/Untag, and up to 16 groups of VLAN are also supported.

An intelligent address recognition algorithm allows Samurai-6M/6MX (ADM6996M/MX) to recognize up to 2K different MAC addresses and enables filtering and forwarding at full wire speed.

Port MAC address Locking function is also supported by Samurai-6M/6MX (ADM6996M/MX) to use on building Internet access to prevent multiple users sharing one port.

1.2 Features

- Five 10M/100M auto-detect Half/Full duplex switch ports with **TX/FX** interfaces and one MII/GPSI/RMII port
- 2K MAC address tables with 4-ways associative hash algorithm
- Four queues for QoS
- Priority features by Port-Based, 802.1p, IP TOS, Diffserv, TCP/UDP Destination Port Application-Based of packets
- Store & Forward architecture and performs forwarding and filtering at non-blocking full wire speed
- Per port Single/Dual color mode with Power On auto diagnostic. Collision/Duplex LED can be separated using register setting
- 802.3x Flow Control pause packet for Full Duplex
- Back Pressure function for Half Duplex operation
- Supports packet lengths up to 1518/1522 (Default)/1536/1784 bytes in maximum
- Scalable Per Port Bandwidth Control (Both Ingress and Egress). (Step = 64K, up to 100M)
- Broadcast/Multicast Storm Suppression
- 802.1Q VLAN. Up to 16 VLAN groups are implemented by full 12 bits VID matching
- MAC clone function to enable multiple WAN application
- TP interface Auto MDIX function for auto TX/RX swap by strapping-pin.

- Interrupt pin, Interrupt Register and Interrupt Mask Register. Programmable interrupt polarity (Default active low)
- Easy Management 32-bit smart counter for per port RX/TX byte/packet count, 16-bit smart counter for per port ERROR count and Collision count
- Supports 32 hardware IGMP Table (Multicast Table)
- MAC Address Table is accessible
- Supports 802.1x security function
- Supports Spanning Tree Protocol
- Supports internal counter/PHY status output for management system
- 25M Crystal
- 128 QFP package with 0.18 μm technology. 1.8 V/3.3 V power supply.
- 1.0 W low power consumption.

1.3 Applications

Samurai-6M/6MX (ADM6996M/MX):

- SOHO 5-port switch
- 5-port switch + Router with 2 MII CPU interface

1.4 Block Diagram

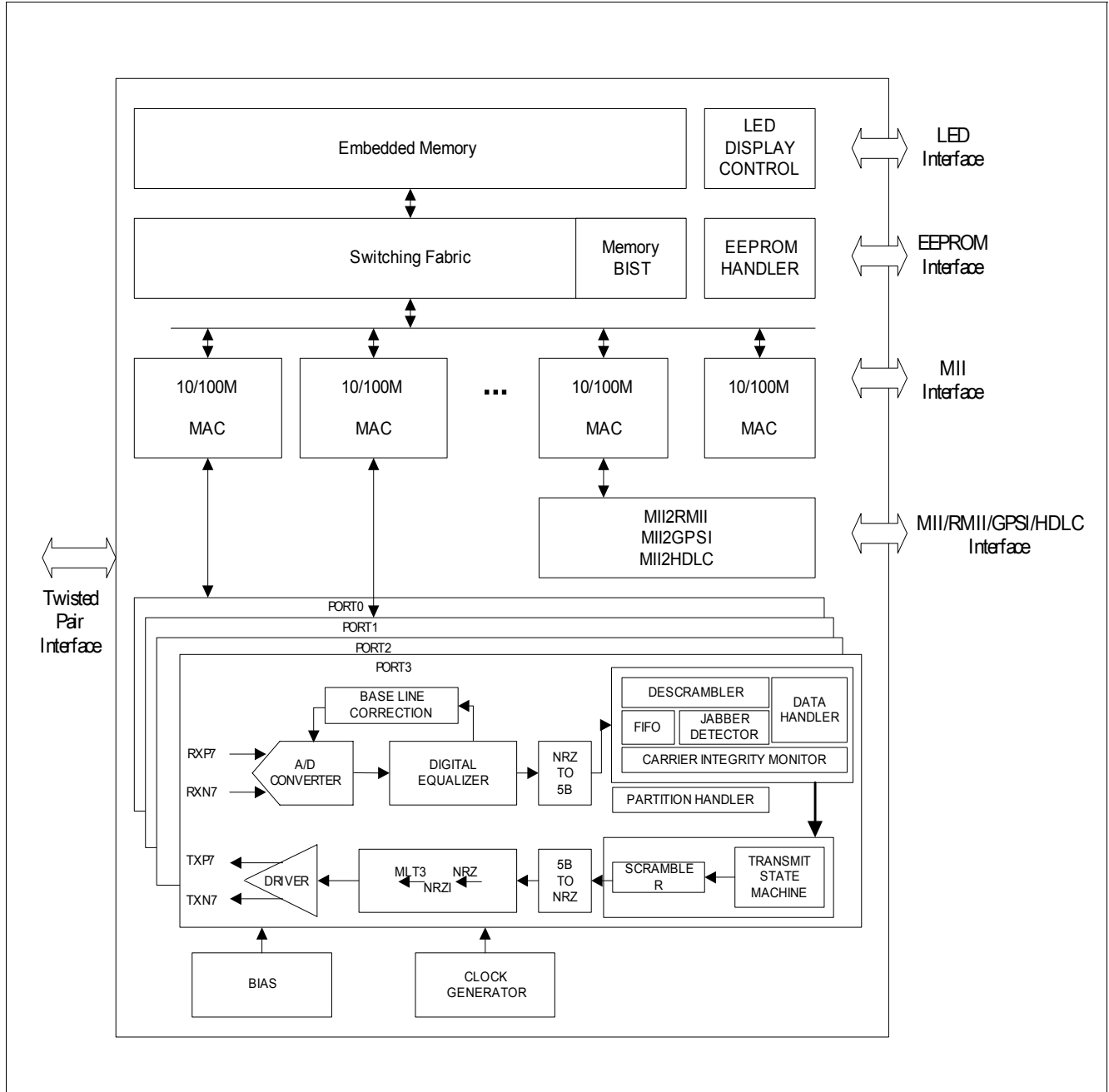

Figure 1 Samurai-6M/6MX (ADM6996M/MX) Block Diagram

1.5 Data Lengths

- qword: 64 bits
- dword: 32 bits
- word: 16 bits
- byte: 8 bits
- nibble: 4 bits

2 Interface Description

This chapter describes the interface descriptions for the Samurai-6M/6MX (ADM6996M/MX)

- Pin Diagram
- Abbreviations
- Pin Description by Function

2.1 Pin Diagram

Figure 2 shows the pin diagram for the Samurai-6M/6MX (ADM6996M/MX).

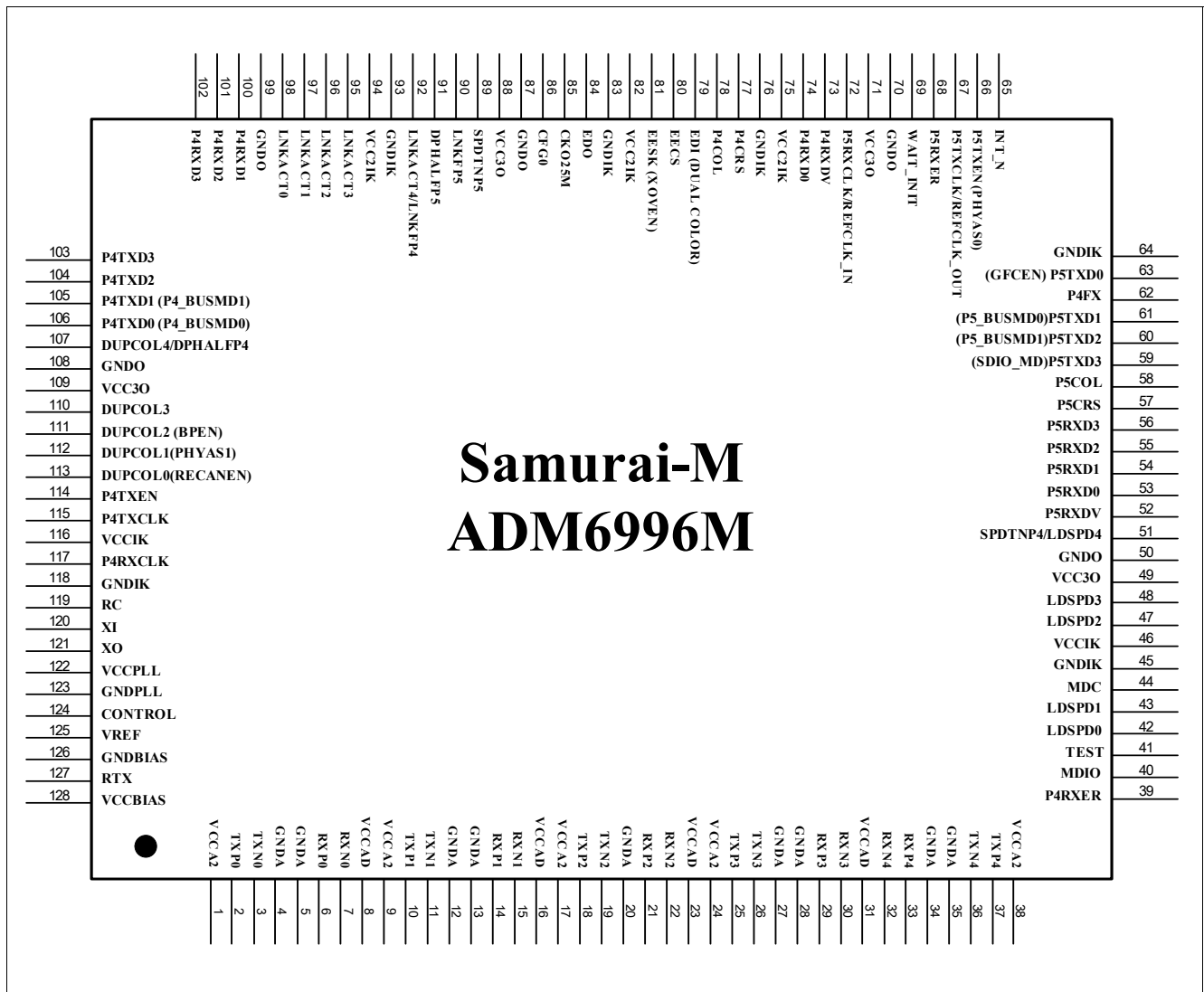

Figure 2 4 TP/FX PORT + 2 MII PORT 128 Pin Diagram

2.2 Abbreviations

Standard abbreviations for I/O tables:

Table 1 Abbreviations for Pin Type

Abbreviations	Description
I	Standard input-only pin. Digital levels.
O	Output. Digital levels.
I/O	I/O is a bidirectional input/output signal.
AI	Input. Analog levels.
AO	Output. Analog levels.
AI/O	Input or Output. Analog levels.
PWR	Power
GND	Ground
MCL	Must be connected to Low (JEDEC Standard)
MCH	Must be connected to High (JEDEC Standard)
NU	Not Usable (JEDEC Standard)
NC	Not Connected (JEDEC Standard)

Table 2 Abbreviations for Buffer Type

Abbreviations	Description
Z	High impedance
PU	Pull up, 10 k Ω
PD	Pull down, 10 k Ω
TS	Tristate capability: The corresponding pin has 3 operational states: Low, high and high-impedance.
OD	Open Drain. The corresponding pin has 2 operational states, active low and tristate, and allows multiple devices to share as a wire-OR. An external pull-up is required to sustain the inactive state until another agent drives it, and must be provided by the central resource.
OC	Open Collector
PP	Push-Pull. The corresponding pin has 2 operational states: Active-low and active-high (identical to output with no type attribute).
OD/PP	Open-Drain or Push-Pull. The corresponding pin can be configured either as an output with the OD attribute or as an output with the PP attribute.
ST	Schmitt-Trigger characteristics
TTL	TTL characteristics

2.3 Pin Description by Function

Samurai-6M/6MX (ADM6996M/MX) pins are categorized into one of the following groups:

- Network Media Connection
- Port 4 MII Interface
- Port 5 MII Interface
- LED Interface
- EEPROM Interface
- Power/Ground, 48 pins
- Miscellaneous

Note: [Table 1](#) can be used for reference.

Table 3 IO Signals

Pin or Ball No.	Name	Pin Type	Buffer Type	Function
Network Media Connection				
33	RXP_4	AI/O	ANA	Receive Pair Differential data is received on this pin.
29	RXP_3			
21	RXP_2			
14	RXP_1			
6	RXP_0			
32	RXN_4	AI/O	ANA	
30	RXN_3			
22	RXN_2			
15	RXN_1			
7	RXN_0			
37	TXP_4	AI/O	ANA	Transmit Pair Differential data is transmitted on this pin.
25	TXP_3			
18	TXP_2			
10	TXP_1			
2	TXP_0			
36	TXN_4	AI/O	ANA	
26	TXN_3			
19	TXN_2			
11	TXN_1			
3	TXN_0			
Port 4 MII Interface				
74	MMII_P4RXD0	I	PD, LVTTTL	Port 4 Receive Data Bit 0 in MAC MII Mode In MAC MII mode, the bit is the LSB of MII receive data, synchronous to the rising edge of MMII_P4RXCLK.
	PMII_P4RXD0	O	8 mA, PD, LVTTTL	Port 4 Receive Data Bit 0 in PCS MII Mode When port 4 is operating in PCS MII mode, the bit is the LSB of MII receive data output and synchronous to the rising edge of PMII_P4RXCLK.
102	MMII_P4RXD3	I	PD, LVTTTL	Port 4 Receive Data Bit 3 in MAC MII Mode In MAC MII mode, this bit is bit[3] of MII receive data, and synchronous to the rising edge of MMII_P4RXCLK.
	PMII_P4RXD3	O	8 mA, PD, LVTTTL	Port 4 Receive Data Bit 3 in PCS MII Mode When port 4 is operating in PCS MII mode, this pin is bit[3] of MII receive data output and synchronous to the rising edge of PMII_P4RXCLK.

Table 3 IO Signals (cont'd)

Pin or Ball No.	Name	Pin Type	Buffer Type	Function
101	MMII_P4RXD2	I	PD, LVTTTL	Port 4 Receive Data Bit 2 in MAC MII Mode In MAC MII mode, this pin is bit[2] of MII receive data, and synchronous to the rising edge of MMII_P4RXCLK.
	PMII_P4RXD2	O	8 mA, PD, LVTTTL	Port 4 Receive Data Bit 2 in PCS MII Mode When port 4 is operating in PCS MII mode, this pin is bit[2] of MII receive data output and synchronous to the rising edge of PMII_P4RXCLK.
100	MMII_P4RXD1	I	PD, LVTTTL	Port 4 Receive Data Bit 1 in MAC MII Mode In MAC MII mode, this pin is bit[1] of MII receive data, and synchronous to the rising edge of MMII_P4RXCLK.
	PMII_P4RXD1	O	8 mA, PD, LVTTTL	Port 4 Receive Data Bit 1 in PCS MII Mode When port 4 is operating in PCS MII mode, this pin is bit[1] of MII receive data output and synchronous to the rising edge of PMII_P4RXCLK.
73	MMII_P4RXDV	I	PD, LVTTTL	Port 4 Receive Data Valid in MAC MII Mode Active high to indicate that the data on MMII_P4RXD[3:0] is valid. Synchronous to the rising edge of MMII_P4RXCLK.
	PMII_P4RXDV	O	8 mA, PD, LVTTTL	Port 4 Receive Data Valid in PCS MII Mode When port 4 is operating in PCS MII mode, this pin is an active high output signal to indicate PMII_P4RXD[3:0] is valid. Synchronous to the rising edge of PMII_P4RXCLK.
39	MII_P4RXER	I	PD, LVTTTL	Port 4 Receive Error in MAC MII Mode Active high to indicate that there is symbol error on the MII_P4RXD[3:0]. Only valid in 100M operation.
77	MMII_P4CRS	I	PD, LVTTTL	Port 4 Carrier Sense in MAC MII Mode In full duplex mode, MMII_P4CRS reflects the receive carrier sense situation on medium only; In Half Duplex, CRS will be high both in receive and transmit condition.
	PMII_P4CRS	O	8 mA, PD, LVTTTL	Port 4 Carrier Sense in PCS MII Mode When port 4 is operating in PCS MII mode, this pin is used to output Carrier Sense status.
78	MMII_P4COL	I	PD, LVTTTL	Port 4 Collision input in MAC MII Mode Active high to indicate that there is collision on the medium. Stay low in full duplex operation.
	PMII_P4COL	O	8 mA, PD, LVTTTL	Port 4 Collision output in PCS MII Mode When port 4 is operating in PCS MII mode, this pin is used to output collision status.

Table 3 IO Signals (cont'd)

Pin or Ball No.	Name	Pin Type	Buffer Type	Function
106	P4_BUSMD0	I	PD, LVTTTL	Port 4 Bus Type Configuration 0 Value on this pin will be latched by Samurai-6M/6MX (ADM6996M/MX) at the rising edge of RESETL(RC) for Port 4 Configuration Bit 0. Combined with CFG0 and P4_BUSMD1 , Samurai-6M/6MX (ADM6996M/MX) provides 4 bus type for port 4. See CFG0 pin description for more details. <i>Note: Power On Setting</i>
	MMII_P4TXD0	O	8 mA, PD, LVTTTL	Port 4 Transmit Data Bit 0 in MAC MII Mode The LSB bit of MAC MII Transmit data of port 4. Synchronous to the rising edge of MMII_P4TXCLK.
	PMII_P4TXD0	I	PD, LVTTTL	Port 4 Transmit Data Bit 0 in PCS MII Mode When port 4 is operating in PCS MII mode, this pin is the LSB of MII transmit data input and synchronous to the rising edge of PMII_P4TXCLK.
105	P4_BUSMD1	I	PD, LVTTTL	Port 4 Bus Type Configuration 1 Value on this pin will be latched by Samurai-6M/6MX (ADM6996M/MX) at the rising edge of RESETL(RC) for Port 4 Configuration Bit 1. Combined with CFG0 and P4_BUSMD0 , Samurai-6M/6MX (ADM6996M/MX) provides 4 bus type for port 4. See CFG0 for more details. <i>Note: Power On Setting</i>
	MMII_P4TXD1	O	8 mA, PD, LVTTTL	Port 4 Transmit Data Bit 1 in MAC MII Mode The bit[1] of MAC MII Transmit data of port 4. Synchronous to the rising edge of MMII_P4TXCLK.
	PMII_P4TXD1	I	PD, LVTTTL	Port 4 Transmit Data Bit 1 in PCS MII Mode When port 4 is operating in PCS MII mode, this pin is bit[1] of MII transmit data input and synchronous to the rising edge of PMII_P4TXCLK.
103	MMII_P4TXD3	O	8 mA, PD, LVTTTL	Port 4 Transmit Data Bit 3 in MAC MII Mode The bit[3] of MAC MII Transmit data of port 4. Synchronous to the rising edge of MMII_P4TXCLK.
	PMII_P4TXD3	I	PD, LVTTTL	Port 4 Transmit Data Bit 3 in PCS MII Mode When port 4 is operating in PCS MII mode, this pin is bit[3] of MII transmit data input and synchronous to the rising edge of PMII_P4TXCLK.
104	MMII_P4TXD2	O	8 mA, PD, LVTTTL	Port 4 Transmit Data Bit 2 in MAC MII Mode The bit[2] of MAC MII Transmit data of port 4. Synchronous to the rising edge of MMII_P4TXCLK.
	PMII_P4TXD2	I	PD, LVTTTL	Port 4 Transmit Data Bit 2 in PCS MII Mode When port 4 is operating in PCS MII mode, this pin is bit[2] of MII transmit data input and synchronous to the rising edge of PMII_P4TXCLK.

Table 3 IO Signals (cont'd)

Pin or Ball No.	Name	Pin Type	Buffer Type	Function
114	MMII_P4TXEN	O	8 mA, PD, LVTTTL	Port 4 Transmit Enable in MAC MII Mode Output by Samurai-6M/6MX (ADM6996M/MX) at the rising edge of MMII_P4TXCLK when Samurai-6M/6MX (ADM6996M/MX) is programmed to MAC Type MII.
	PMII_P4TXEN	I	PD, LVTTTL	Port 4 Transmit Enable in PCS MII Mode It is the MII Transmit Enable input to Samurai-6M/6MX (ADM6996M/MX) when programmed to PCS Type MII.
117	MMII_P4RXCLK	I	PD, LVTTTL	Port 4 Receive Clock in MAC MII Mode 25MHz Free Running clock in 100M Mode and 2.5 MHz free running clock in 10M Mode. MMII_P4RXDV and MMII_P4RXD[3:0] should be synchronous to the rising edge of this clock
	PMII_P4RXCLK	O	8 mA, PD, LVTTTL	Port 4 Receive Clock in PCS MII Mode 25MHz Free Running clock in 100M Mode and 2.5 MHz free running clock in 10M Mode. PMII_P4RXDV and PMII_P4RXD[3:0] should be synchronous to the rising edge of this clock
115	MMII_P4TXCLK	I	PD, LVTTTL	Port 4 Transmit Clock in MAC MII Mode 25MHz Free Running clock in 100M Mode and 2.5 MHz free running clock in 10M Mode. MMII_P4TXEN and MMII_P4TXD[3:0] should be synchronous to the rising edge of this clock
	PMII_P4TXCLK	O	8 mA, PD, LVTTTL	Port 4 Transmit Clock in PCS MII Mode 25MHz Free Running clock in 100M Mode and 2.5 MHz free running clock in 10M Mode. PMII_P4TXEN and PMII_P4TXD[3:0] should be synchronous to the rising edge of this clock
62	P4FX	I	PD, LVTTTL	Port 4 Fiber Selection for PCS MII/PHY mode During power on reset, value will be latched by Samurai-6M/6MX (ADM6996M/MX) at the rising edge of RESETL(RC) as port 4 Fiber select. 0 _B , Twisted Pair Mode 1 _B , Fiber Mode

Table 3 IO Signals (cont'd)

Pin or Ball No.	Name	Pin Type	Buffer Type	Function
Port 5 MII Interface				
63	GFCEN	I	PU, LVTTTL	<p>Global Flow Control Enable Value on this pin will be latched by Samurai-6M/6MX (ADM6996M/MX) at the rising edge of RESETL(RC) as Flow control enable. <i>Note: Power On Setting</i></p> <p>0_B , Flow Control Capability is depended upon the register setting in corresponding port's Basic Control Register 1_B , All ports flow control capability is enabled</p>
	MII_P5TXD0	O	4 mA, PU, LVTTTL	<p>Port 5 Transmit Data Bit 0 in MII Mode The LSB bit of MII Transmit data of port 5. Synchronous to the rising edge of MII_P5TXCLK.</p>
	GPSI_P5TXD	O	4 mA, PU, LVTTTL	<p>Port 5 Transmit Data in GPSI Mode When port 5 is operating in GPSI mode, this pin acts as GPSI Transmit Data. Synchronous to the rising edge of GPSI_P5TXCLK.</p>
	RMII_P5TXD0	O	4 mA, PU, LVTTTL	<p>Port 5 Transmit Data Bit 0 in RMII Mode When port 5 is operating in RMII mode, this pin acts as RMII Transmit Data Bit[0]. Synchronous to the rising edge of REFCLK_IN.</p>
61	P5_BUSMD0	I	PD, LVTTTL	<p>Port 5 Bus Mode Selection Bit 0 Value on this pin will be latched by Samurai-6M/6MX (ADM6996M/MX) at the rising edge of RESETL(RC) as port 5 bus mode selection bit 0. Combined with P5_BUSMD1, Samurai-6M/6MX (ADM6996M/MX) provides 3 bus types for port 5. P5_BUSMD[1:0], Interface <i>Note: Power On Setting</i></p> <p>00_B , MII 01_B , GPSI 10_B , RMII 11_B , Reserved and not allowed</p>
	MII_P5TXD1	O	4 mA, PD, LVTTTL	<p>Port 5 Transmit Data Bit 1 in MII Mode The bit[1] of MII Transmit data of port 5. Synchronous to the rising edge of MII_P5TXCLK.</p>
	RMII_P5TXD1	O	4 mA, PD, LVTTTL	<p>Port 5 Transmit Data Bit 1 in RMII Mode The bit[1] of RMII Transmit data of port 5. Synchronous to the rising edge of REFCLK_IN.</p>

Table 3 IO Signals (cont'd)

Pin or Ball No.	Name	Pin Type	Buffer Type	Function
60	P5_BUSMD1	I	PD, LVTTTL	<p>Port 5 Bus Mode Selection Bit 1 Value on this pin will be latched by Samurai-6M/6MX (ADM6996M/MX) at the rising edge of RESETL(RC) as port 5 bus mode selection bit 1. See P5_BUSMD0 for more details. <i>Note: Power On Setting</i></p>
	MII_P5TXD2	O	4 mA, PD, LVTTTL	<p>Port 5 Transmit Data Bit 2 in MII Mode The bit[2] of MII Transmit data of port 5. Synchronous to the rising edge of MII_P5TXCLK.</p>
59	SDIO_MD	I	PD, LVTTTL	<p>SDC/SDIO Mode Selection Value on this pin will be latched by Samurai-6M/6MX (ADM6996M/MX) at the rising edge of RESETL(RC) as SDC/SDIO control signal which is used to select 16 bit mode. <i>Note: Power On Setting</i> 0_B, 16 bits mode, MDC/MDIO timing compatible</p>
	MII_P5TXD3	O	4 mA, PD, LVTTTL	<p>Port 5 Transmit Data Bit 3 in MII Mode The MSB bit of MII Transmit data of port 5. Synchronous to the rising edge of MII_P5TXCLK.</p>
66	PHYAS0	I	PD, LVTTTL	<p>PHY Address MSB Bit 0 During power on reset, value will be latched by Samurai-6M/6MX (ADM6996M/MX) at the rising edge of RESETL(RC) as PHY start address select. PHYAS[1:0] = 00_B and PHY address starts from 01000_B. <i>Note: Power On Setting</i></p>
	MII_P5TXEN	O	8 mA, PD, LVTTTL	<p>Port 5 Transmit Enable TXEN in MII Mode Active high to indicate that the data on MII_P5TXD[3:0] is valid. Synchronous to the rising edge of MII_P5TXCLK.</p>
	GPSI_P5TXEN	O	8 mA, PD, LVTTTL	<p>Port 5 Transmit Enable TXEN in GPSI Mode Active high to indicate that the data on GPSI_P5TXD is valid. Synchronous to the rising edge of GPSI_P5TXCLK.</p>
	RMII_P5TXEN	O	8 mA, PD, LVTTTL	<p>Port 5 Transmit Enable TXEN in RMII Mode Active high to indicate that the data on RMII_P5TXD[1:0] is valid. Synchronous to the rising edge of REFCLK_IN.</p>
53	MII_P5RXD0	I	PD, LVTTTL	<p>Port 5 Receive Data Bit 0 in MII Mode In MII mode, the bit is the LSB of MII receive data, synchronous to the rising edge of MII_P5RXCLK.</p>
	GPSI_P5RXD	I	PD, LVTTTL	<p>Port 5 Receive Data in GPSI Mode In GPSI Mode, this acts as Receive Data Input, synchronous to the rising edge of GPSI_P5RXCLK.</p>
	RMII_P5RXD0	I	PD, LVTTTL	<p>Port 5 Receive Data Bit 0 in RMII Mode In RMII mode, the bit is the LSB of RMII receive data, synchronous to the rising edge of REFCLK_IN.</p>

Table 3 IO Signals (cont'd)

Pin or Ball No.	Name	Pin Type	Buffer Type	Function
54	MII_P5RXD1	I	PD, LVTTTL	Port 5 Receive Data Bit 1 in MII Mode In MII mode, the bit is the bit[1] of MII receive data, synchronous to the rising edge of MII_P5RXCLK.
	RMII_P5RXD1	I	PD, LVTTTL	Port 5 Receive Data Bit 1 in RMII Mode In RMII mode, the bit is the MSB of RMII receive data, synchronous to the rising edge of REFCLK_IN.
55	MII_P5RXD2	I	PD, LVTTTL	Port 5 Receive Data Bit 2 in MII Mode In MII mode, the bit is the bit[2] of MII receive data. Synchronous to the rising edge of MII_P5RXCLK.
56	MII_P5RXD3	I	PD, LVTTTL	Port 5 Receive Data Bit 3 in MII Mode In MII mode, the bit is the bit[3] of MII receive data. Synchronous to the rising edge of MII_P5RXCLK.
52	MII_P5RXDV	I	PD, LVTTTL	Port 5 Receive Data Valid in MII Mode Active high to indicate that the data on MII_P5RXD[3:0] is valid. Synchronous to the rising edge of MII_P5RXCLK.
	RMII_P5CRSDV	I	PD, LVTTTL	Port 5 Carrier Sense and Receive Data Valid in RMII Mode Active high to indicate that the data on RMII_P5RXD[1:0] is valid. Synchronous to the rising edge of REFCLK_IN.
68	MII_P5RXER	I	PD, LVTTTL	Port 5 Receive Error in MII Mode Active high to indicate that there is symbol error on the MII_P5RXD[3:0]. Only valid in 100M operation.
	RMII_P5RXER	I	PD, LVTTTL	Port 5 Receive Error in RMII Mode Active high to indicate that there is symbol error on the RMII_P5RXD[1:0]. Only valid in 100M operation.
57	MII_P5CRS	I	PD, LVTTTL	Port 5 Carrier Sense in MII Mode In full duplex mode, MII_P5CRS reflects the receive carrier sense situation on medium only; In Half Duplex, MII_P5CRS will be high both in receive and transmit condition.
	GPSI_P5CRS	I	PD, LVTTTL	Port 5 Carrier Sense in GPSI Mode In full duplex mode, GPSI_P5CRS reflects the receive carrier sense situation on medium only; In Half Duplex, GPSI_P5CRS will be high both in receive and transmit condition.
58	MII_P5COL	I	PD, LVTTTL	Port 5 Collision Input in MII Mode Active high to indicate that there is collision on the medium. Stay low in full duplex operation.
	GPSI_P5COL	I	PD, LVTTTL	Port 5 Collision Input in GPSI Mode Active high to indicate that there is collision on the medium. Stay low in full duplex operation.

Table 3 IO Signals (cont'd)

Pin or Ball No.	Name	Pin Type	Buffer Type	Function
72	MII_P5RXCLK	I	PD, LVTTTL	Port 5 Receive Clock Input in MII Mode MII_P5RXDV and MII_P5RXD[3:0] are synchronous to the rising edge of this clock. It is free running 25 MHz clock in 100M mode and 2.5 MHz clock in 10M mode.
	GPSI_P5RXCLK	I	PD, LVTTTL	Port 5 Receive Clock Input in GPSI Mode GPSI_P5RXD are synchronous to the rising edge of this clock. It is non-continuous 10 MHz Clock input.
	REFCLK_IN	I	PD, LVTTTL	50MHz Reference Clock Input in RMII Mode RMII_P5RXD[1:0], RMII_P5TXD[1:0], RMII_P5TXEN and RMII_P5CRSDV are synchronous to the rising edge of this clock.
67	MII_P5TXCLK	I	PD, LVTTTL	Port 5 Transmit Clock Input in MII Mode MII_P5TXEN and MII_P5TXD[3:0] are output at the rising edge of this clock. It is free running 25 MHz clock in 100M mode and 2.5 MHz clock in 10M mode.
	GPSI_P5TXCLK	I	PD, LVTTTL	Port 5 Transmit Clock Input in GPSI Mode GPSI_P5TXEN and GPSI_P5TXD are synchronous to the rising edge of this clock. It is continuous 10 MHz Clock input.
	REFCLK_OUT	O	8 mA, PD, LVTTTL	50MHz Reference Clock Output in RMII Mode This pin is used as 50 MHz reference clock signal output pin when port 5 operates in RMII mode.
89	SPDTNP5	I	PD, LVTTTL	Port 5 Speed Input 0 _B , 100M 1 _B , 10M
90	LNKFP5	I	PD, LVTTTL	Port 5 Link Fail Status Input 0 _B , Link Up 1 _B , Link Failed
91	DPHALFP5	I	PD, LVTTTL	Port 5 Duplex Status Input 0 _B , Full Duplex 1 _B , Half Duplex

LED Interface

107	DPHALFP4	I	PD, LVTTTL	Port 4 Duplex status Input When Port 4 operates under MAC MII mode (see CFG0 for more details), this pins is used to select the duplex mode of Port 4. 0 _B , Full Duplex 1 _B , Half Duplex
	DUPCOL4	O	8 mA, PD, LVTTTL	Port 4 Duplex /Collision LED When Port 4 operates under PHY or PCS MII mode (see CFG0 for more details), in Full duplex mode, this pin acts as DUPLEX LED for Port 4; in half duplex mode, it is collision LED for each port. See Chapter 3.1.12 LED Display for more details.

Table 3 IO Signals (cont'd)

Pin or Ball No.	Name	Pin Type	Buffer Type	Function
110	DUPCOL3	O	8 mA, PD, LVTTTL	Port 3 Duplex /Collision LED In Full duplex mode, this pin acts as DUPLEX LED for Port 3; in half duplex mode, it is collision LED for each port. See Chapter 3.1.12 LED Display for more details.
111	BPEN	I	PU, LVTTTL	Recommend Back-Pressure in Half-Duplex Value on this pin will be latched by Samurai-6M/6MX (ADM6996M/MX) during power on reset as the back-pressure enable in half-duplex mode. <i>Note: Power On Setting</i> 0_B , Disable Back-Pressure 1_B , Enable Back-Pressure
	DUPCOL2	O	8 mA, PU, LVTTTL	Port 2 Duplex-collision LED In Full duplex mode, this pin acts as Port 2 DUPLEX LED; in half duplex mode, it is collision LED for Port 2. See Chapter 3.1.12 LED Display for more details.
112	PHYAS1	I	PD, LVTTTL	Recommend PHY Address Bit 1 Value on this pin will be latched by Samurai-6M/6MX (ADM6996M/MX) during power on reset as the PHY address recommends value bit 1. See PHYAS0 description for more details. <i>Note: Power On Setting</i>
	DUPCOL1	O	8 mA, PD, LVTTTL	Port 1 Duplex-collision LED In Full duplex mode, this pin acts as port 1 DUPLEX LED; in half duplex mode, it is collision LED for Port 1. See Chapter 3.1.12 LED Display for more details.
113	RECANEN	I	PU, LVTTTL	Recommend Auto Negotiation Enable Only valid for Twisted pair interface. Programmed this bit to 1 has no effect to Fiber port. <i>Note: Power On Setting.</i> 0_B , Disable all TP port auto negotiation capability 1_B , Enable all TP port auto negotiation capability
	DUPCOL0	O	8 mA, PU, LVTTTL	Port 0 Duplex-collision LED In Full duplex mode, this pin acts as port 0 DUPLEX LED; in half duplex mode, it is collision LED for Port 0. See Chapter 3.1.12 LED Display for more details.

Table 3 IO Signals (cont'd)

Pin or Ball No.	Name	Pin Type	Buffer Type	Function
92	LNKFP4	I	PD, LVTTTL	Port 4 Link Fail Status Input When Port 4 operates under MAC MII mode (see CFG0 for more details), this pin is used as link control of Port 4. 0 _B , Link Up 1 _B , Link Failed
	LNKACT_4	O	8 mA, PD, LVTTTL	LINK/Activity LED of Port 4 When Port 4 operates under PHY or PCS MII mode (see CFG0 for more details), this pin is used to indicate the link/activity status of Port 4, see Chapter 3.1.12 LED Display for more details.
95	LNKACT_3	O	8 mA, PD, LVTTTL	LINK/Activity LED of Port 3 to 0 Used to indicate corresponding port' s link/activity status, see Chapter 3.1.12 LED Display for more details.
96	LNKACT_2			
97	LNKACT_1			
98	LNKACT_0			
51	SPDTNP4	I	PD, LVTTTL	Port 4 Speed Input When Port 4 operates under MAC MII mode (see CFG0 for more details), this pin is used to select the operating speed of Port 4. 0 _B , 100M 1 _B , 10M
	LDSPD_4	O	8 mA, PD, LVTTTL	Port 4 Speed LED When Port 4 operates under PHY or PCS MII mode (see CFG0 for more details), this pin is used to indicate the speed status of Port 4, see Chapter 3.1.12 LED Display for more details.
48	LDSPD_3	O	8 mA, PD, LVTTTL	Port 3 to Port 0 Speed LED Used to indicate corresponding port' s speed status, see Chapter 3.1.12 LED Display for more details.
47	LDSPD_2			
43	LDSPD_1			
42	LDSPD_0			
EEPROM Interface				
84	EDO	I	PU, LVTTTL	EEPROM Data Output This pin is used to input EEPROM data when reading EEPROM. During Samurai-6M/6MX (ADM6996M/MX) initialisation, Samurai-6M/6MX (ADM6996M/MX) will drive EEPROM interface signal to read settings from EEPROM. Any other devices attached to EEPROM interface SHOULD drive Hi-Z or keep tristate during this period. See Chapter 3.4.2 EEPROM Interface for more details.

Table 3 IO Signals (cont'd)

Pin or Ball No.	Name	Pin Type	Buffer Type	Function
80	IFSEL	I	PD, LVTTTL	<p>Interface Selection After Samurai-6M/6MX (ADM6996M/MX) initialization process is done, this pin is used to select using EEPROM interface or SDC/SDIO interface. EECS/IFSEL interface 0_B , SDC/SDIO interface 1_B , EEPROM interface</p>
	EECS	O	4 mA, PD, LVTTTL	<p>EEPROM Chip Select During Samurai-6M/6MX (ADM6996M/MX) initialisation, this pin is used as EEPROM chip select signal. During Samurai-6M/6MX (ADM6996M/MX) initialize itself, Samurai-6M/6MX (ADM6996M/MX) will drive EEPROM interface signal to read settings from EEPROM. Any other devices attached to EEPROM interface SHOULD drive Hi-Z or keep tristate during this period. See Chapter 3.4.2 EEPROM Interface for more details.</p>
81	XOVEN	I	PD, LVTTTL	<p>Cross Over Enable Value on this pin (active low) will be latched by Samurai-6M/6MX (ADM6996M/MX) at the rising edge of RESETL(RC) for Port 4~0 crossover auto detect (Only available in TP interface). <i>Note: Power On Setting.</i> 0_B , Disable 1_B , Enable</p>
	EESK	I/O	4 mA, PD, LVTTTL	<p>EEPROM Serial Clock During Samurai-6M/6MX (ADM6996M/MX) initialisation, this pin is used to output clock to EEPROM. After Samurai-6M/6MX (ADM6996M/MX) initialization process is done, this pin is used as EEPROM interface clock input if IFSEL = 1.</p>
	SDC	I	PD, LVTTTL	<p>Serial Management interface Clock input If IFSEL = 0, this pin is used as serial management interface clock input.</p>

Table 3 IO Signals (cont'd)

Pin or Ball No.	Name	Pin Type	Buffer Type	Function
79	LED_MODE	I	PD, LVTTTL	Enable Mac to Choose LED Display Mode Value on this pin will be latched by Samurai-6M/6MX (ADM6996M/MX) at the rising edge of RESETL(RC) as single/dual color LED mode control signal. See Chapter 3.1.12 LED Display for more details. <i>Note: Power On Setting.</i>
	EDI	I/O	8 mA, PD, LVTTTL	EEPROM Serial Data Input During Samurai-6M/6MX (ADM6996M/MX) initialize itself, this pin is used to output address and command to access EEPROM. After the initialization process is done, this pin becomes an input pin to monitor EEPROM data if IFSEL = 1.
	SDIO	I/O	8 mA, PD, LVTTTL	Serial Management interface Data input/Output If IFSEL = 0, this pin is used as data input/output pin of serial management interface.

Power/Ground, 48 Pins

4, 5, 12, 13, 20, 27, 28, 34, 35	GNDA	GND	–	Ground Used by AD Block
1, 9, 17, 24, 38	VCCA2	PWR	–	1.8 V, Power Used by TX Line Driver
8, 16, 23, 31	VCCAD	PWR	–	3.3 V, Power Used by AD Block
126	GNDBIAS	GND	–	Ground Used by Bias Block
128	VCCBIAS	PWR	–	3.3 V, Power Used by Bias Block.
123	GNDPLL	GND	–	Ground Used by PLL
122	VCCPLL	PWR	–	1.8 V, Power Used by PLL
45, 64, 76, 83, 93, 118	GNDIK	GND	–	Ground Used by Digital Core
46, 75, 82, 94, 116	VCCIK	PWR	–	1.8 V, Power Used by Digital Core
50, 70, 87, 99, 108	GNDO	GND	–	Ground Used by Digital Pad
49, 71, 88, 109	VCC3O	PWR	–	3.3 V, Power Used by Digital Pad

Miscellaneous

41	TEST	I	PD, LVTTTL	Test Mode Reserved and should keep 0 when normal operation.
----	------	---	------------	---

Table 3 IO Signals (cont'd)

Pin or Ball No.	Name	Pin Type	Buffer Type	Function
86	CFG0	I	PU, LVTTTL	Configuration 0 Combined with P4_BUSMD0 and P4_BUSMD1 , Samurai-6M/6MX (ADM6996M/MX) provides 3 bus type for port 4. {CFG0, P4_BUSMD[1:0]}, Bus Mode of Port 4 0_00 _B , PHY Interface 0_01 _B , MAC MII 1_XX _B , PCS MII
69	WAIT_INIT	I	PD, LVTTTL	Wait Initialization This pin will be used to pause all activities after power up until EEPROM is loaded successfully or CPU initialization is done.. 0 _B , pause until loading EEPROM is done. 1 _B , pause until EEPROM successfully loaded or CPU initialization is done.
65	INT_N	O	OD,8 mA	Interrupt Active low interrupt signal to indicate the status change in the interrupt status register. Interrupt signal will keep active low until host read the status of ISR register. 0 _B , Interrupt 1 _B , Not interrupt
40	MDIO	I/O	8 mA, PD, LVTTTL	Management Data MDIO transfers management data in and out of the device synchronous to MDC.
44	MDC	I	PD, ST	Management Data Reference Clock A non-continuous clock input for management usage. Samurai-6M/6MX (ADM6996M/MX) will use this clock to sample data input on MDIO and drive data onto MDIO according to rising edge of this clock.
85	CKO25M	O	8 mA, PD, LVTTTL	25M Clock Output Free Running 25M Clock output (Even during power on reset)
119	RC	I	ST	RC Input For Power On Reset This pin is sampled by using the 25 MHz free running clock signal which gets the input from XI to generate the low-active reset signal, RESETL. See Chapter 5.3.2 Power On Reset for the timing requirements.
120	XI	AI	ANA	25MHz Crystal /Oscillator Input 25MHz Crystal or Oscillator Input. Variation is limited to +/- 50ppm.
121	XO	AO	ANA	25MHz Crystal Output When connected to oscillator, this pin should be left unconnected.
127	RTX	AI	ANA	Constant Voltage Reference External 1.0 kΩ 1% resistor connection to ground.

Table 3 IO Signals (cont'd)

Pin or Ball No.	Name	Pin Type	Buffer Type	Function
125	VREF	AI	ANA	Analog Reference Voltage Used by Internal Bias Circuit for voltage reference. External 0.1uF capacitor connection to ground for noise filter.
124	CONTROL	AI/O	ANA	FET Control Signal The pin is used to control FET for 3.3 V to 1.8 V regulator. External 0.1uF capacitor connection to ground for noise filter, even the pin is un-connected.

3 Function Description

3.1 Switch Functional Description

The Samurai-6M/6MX (ADM6996M/MX) uses the “store & forward” switching approach for the following reasons:

1. Store & forward switches allow switching between different speed media (e.g. 10BaseX and 100BaseX). Such switches require large elastic buffers, especially when bridging between a server on a 100 Mbit/s network and clients on a 10 Mbit/s segment
2. Store & forward switches improve overall network performance by acting as a “network cache”
3. Store & forward switches prevent the forwarding of corrupted packets by the frame check sequence (FCS) before forwarding to the destination port

3.1.1 Basic Operation

The Samurai-6M/6MX (ADM6996M/MX) receives incoming packets from one of its ports, uses the source address (SA) and FID to update the address table, and then forwards the packet to the output ports determined by the destination address (DA) and FID.

If the DA and FID are not found in the address table, the Samurai-6M/6MX (ADM6996M/MX) treats the packet as a broadcast packet and forwards the packet to the other ports within the same group.

The Samurai-6M/6MX (ADM6996M/MX) can automatically learn the port number of attached network devices together with the SA and FID of all the incoming packets. If the SA and FID are not found in the address table, the Samurai-6M/6MX (ADM6996M/MX) adds it to the table.

3.1.2 Buffers and Queues

The Samurai-6M/6MX (ADM6996M/MX) incorporates 6 transmit queues and receive buffer areas for the 6 Ethernet ports. The receive buffers, as well as the transmit queues, are located within the Samurai-6M/6MX (ADM6996M/MX) along with the switch fabric. The buffers are divided into 192 blocks of 256 bytes each. The queues of each port are managed according to each port’s read/write pointer.

Input buffers and output queues are maintained through proprietary patent pending UNIQUE (Universal Queue management) scheme.

3.1.3 Full Duplex Flow Control

When a full duplex port runs out of its receive buffers, a PAUSE command will be issued by Samurai-6M/6MX (ADM6996M/MX) to notify the packet sender to pause transmission. This frame based flow control is totally compliant to IEEE 802.3x. When the flow control hardware pin (**GFCEN**) is set to high, during power on reset, and per port PAUSE is enabled, Samurai-6M/6MX (ADM6996M/MX) will output and accept 802.3x flow control packets.

3.1.4 Half Duplex Flow Control

Back-pressure is supported for half-duplex operation. When the Samurai-6M/6MX (ADM6996M/MX) cannot allocate a receive buffer for the incoming packet (buffer full), the device will transmit a jam pattern on the port, thus forcing a collision.

3.1.5 Back-Off Algorithm

The Samurai-6M/6MX (ADM6996M/MX) implements the truncated exponential back off algorithm compliant to the 802.3 standard. Samurai-6M/6MX (ADM6996M/MX) will restart the back off algorithm by choosing 0-9 collision

count. After 16 consecutive retransmit trials, the Samurai-6M/6MX (ADM6996M/MX) resets the collision counter. Users can set the Back Off (see 0010_H, **BD**) to disable this function.

3.1.6 Inter-Packet Gap (IPG)

IPG is the idle time between any two successive packets from the same port. The value is 9.6 μs for 10 Mbit/s Ethernet and 960 ns for 100 Mbit/s fast Ethernet. For the receive end, Samurai-6M/6MX (ADM6996M/MX) is designed to tolerate IPG gaps greater than 64 bits. For the transmit end, Samurai-6M/6MX (ADM6996M/MX) will always transmit packets with the minimum IPG gap equal to 96 bits. If users want to shorten the transmission IPG gap, users can enable the Short IPG function (see 000B_H, **TSIE**). Then Samurai-6M/6MX (ADM6996M/MX) will instruct its output MAC to transmit packets in average 92 bits IPG gap.

3.1.7 Trunking Function

Samurai-6M/6MX (ADM6996M/MX) supports only one trunking port. If Port 3 and Port 4 Trunk (see 000B_H, **TE**) function is enabled, Samurai-6M/6MX (ADM6996M/MX) will treat Port 3 and Port 4 as the same port to make the bandwidth equal to 200M. When any of these two ports link fail, the Samurai-6M/6MX (ADM6996M/MX) will automatically change the transmit path from the failed link port to linked one. Output port based load balancing is implemented in Samurai-6M/6MX (ADM6996M/MX), without any users' setting.

3.1.8 Illegal Frames

The Samurai-6M/6MX (ADM6996M/MX) will discard all illegal packets. These packets are

1. Undersized packets: The packets received with the length of less than 64 bytes are discarded
2. Oversized packets: The packets received with the length of more than "MAXPKTLEN" bytes are discarded. See (0011_H, **MPL**) to see how to set the MAXPKTLEN value
3. CRC packets: The packets received with a wrong FCS value are discarded
4. Symbol error packets: The packets received with symbol error are discarded
5. Source violation packets: The packets received with a source violation could be discarded in some cases. See (**Source Violation**) description.
6. VLAN violation packets: The frames received with a VLAN violation can be discarded in some cases. See (**VLAN Violation**) description

3.1.9 Broadcast Storm

Samurai-6M/6MX (ADM6996M/MX) allows users to limit the traffic of the broadcast address (DA = FFFFFFFF_H) to prevent them from blocking the switch bandwidth. If users also want to limit the multicast packets (DA[40] = 1_B), they can set the Multicast Packet Counted into Storming Counter (see 0010_H, **MP**) function. Two threshold and storm enable bits (see 003B_H and 003C_H, **STORM_EN**, **STORM_100_TH**, **STORM_10_TH**) are used to control the broadcast storm.

1. Time Scale. Samurai-6M/6MX (ADM6996M/MX) uses 50ms on a scale to meter the storm packets.

Parameter	Rising Threshold	Falling Threshold
All link ports are 100M	100M Threshold (See 003B _H)	1/2 100M Threshold
Not All link ports are 100M	10M Threshold (See 003C _H)	1/2 10M Threshold

2. Storm keeps on at least 1.6 seconds if any of the ports meet the rising threshold in the 4 consecutive 50 ms intervals. In these 1.6 seconds, the ports meet the rising threshold and will start to discard the broadcast or multicast packets until the 50 ms interval expires. Users could also disable Input Filter (see 000B_H, **IF**) function to forward above packets to the un-congested port instead of discarding directly.

3. Storm finishes. After the 1.6-second storm period, Samurai-6M/6MX (ADM6996M/MX) will check the port that makes the storm on. If all of these ports meet the falling threshold in the 2 consecutive 50 ms intervals and no

other ports meet the rising threshold at the same time, Samurai-6M/6MX (ADM6996M/MX) will treat it the storm has finished.

3.1.10 Bandwidth Control

Samurai-6M/6MX (ADM6996M/MX) supports hardware-based bandwidth control for both ingress and egress traffic. Ingress and egress rate can be limited independently on each port base. The Samurai-6M/6MX (ADM6996M/MX) uses 8 ms on the scale, and the minimum bandwidth control unit is 64 kbit/s so users can configure the rate equal to $K * 64 \text{ kbit/s}$, $1 \leq K \leq 2048$. Samurai-6M/6MX (ADM6996M/MX) maintains two counters (input and output) for each port. For example, if users want to limit rate equal to 64 kbit/s, they should configure the bandwidth control threshold equal to 1. At each time unit, Samurai-6M/6MX (ADM6996M/MX) will add 64 to the counter and decrease the byte length when receiving a packet in this period. When the counter is decreased to zero, we can divide the control behavior into two parts:

For the ingress control, the ingress port will not receive packets any more. If flow control is enabled, Pause packets will be transmitted, if Back Pressure is enabled, Jam packets will be transmitted, and if the above functions are not enabled, the packets will be discarded.

For the egress control, the egress port will not transmit any packets, so the egress bandwidth is controlled.

Samurai-6M/6MX (ADM6996M/MX) allows users to control the ingress and egress bandwidth at the same time (see 0033_H, [Bandwidth Control Enable Register](#)).

For Example, set P0 receive bandwidth control to 6 Mbit/s.

1. Set the receive bandwidth of P0. $N = \{R0BW_TH3, R0BW_TH2, R0BW_TH1, R0BW_TH0, 6'b0\} = 0x005e$
2. Enable P0 receive bandwidth control. Set 0033_H[0]=1

3.1.11 Smart Discard

The Samurai-6M/6MX (ADM6996M/MX) supports a smart mechanism to discard packets early according to their priority to prevent the resource blocked by the low priority. The discard ratio is as follows:

Table 4 Smart Disacrd

Queue	Discard Mode
Queue 3	Discard Mode of Queue 3 in 0010 _H [15:14]
Queue 2	Discard Mode of Queue 2 in 0010 _H [13:12]
Queue 1	Discard Mode of Queue 1 in 0010 _H [11:10]
Queue 0	Discard Mode of Queue 0 in 0010 _H [9:8]

Table 5 Discard Ratio

Discard Mode	00	01	10	11
Utilization 00	0%	0%	0%	0%
Utilization 01	0%	0%	25%	50%
Utilization 11	0%	25%	50%	75%

3.1.12 LED Display

Three LEDs per port are provided by Samurai-6M/6MX (ADM6996M/MX): Link/Act, Duplex/Col and Speed. The dual-color LED mode is also supported by Samurai-6M/6MX (ADM6996M/MX). For easy production purpose, the test signal is sent to each LED at power on reset stage. The LED display mode is controlled by:

1. **DUAL-COLOR-EE** (see 0012_H): It is an EEPROM register to control the dual or single color mode. It is useless when the value (wait_init) on the pin **WAIT_INIT** is low.

2. **LED_MODE**: It is the value latched on the EDI pin during the power on reset. It's also used to control the dual or single color mode and is useless when the value (wait_init) is high.
3. **LED-ENABLE** (see 0012_H): When CPU is attached and this CPU has no ability to pull the EDI to high or low, users may set the wait_init to high to delay the led test, write the correct value to the **DUAL-COLOR-EE**, write 1_B into register **LED-ENABLE**, and then the LED test starts.
4. **DUP_COL_SEP** (see 0012_H): Dupcol LEDs indicate the duplex status only.
5. **DHCOL_LED_EN** (See 0030_H): When enabled, pin DUPCOL0 shows col_10m status and pin DUPCOL1 shows col_100m status. These two LEDs are necessary in the dual-speed hub.

3.1.12.1 Single Color LED Display

Table 6 Single Color LED Display

Pin Name	Status
LNKACT4/LNKACT3/ LNKACT2/LNKACT1/ LNKACT0	<p>These pins have no power on reset values on them, and Samurai-6M/6MX (ADM6996M) uses active low value to drive the LED. So the output values of these pins after the power on reset are shown as follows:</p> <ol style="list-style-type: none"> 1. First period: This period lasts 1.28 s for LED on test. Samurai-6M/6MX (ADM6996M/MX) drives value 0 to open the LED. 2. Second period: This period lasts 0.48 s for LED off test. Samurai-6M/6MX (ADM6996M/MX) drives value 1 to close the LED. 3. Normal Period: This period indicates the link status. 0_B , Port links up and LED is ON. 1_B , Port links down and LED is OFF. 0/1_B , Port links up and is transmitting or receiving. The LED flashes at 10 Hz.
LDSPD4/LDSPD3/ LDSPD2/LDSPD1/ LDSPD0	<p>The behavior of these pins is the same as the LNKACT, except for the normal period.</p> <p>Normal period: This period indicates the speed status. 0_B , Port links up and its speed is 100M. LED is ON. 1_B , Port links down or its speed is 10M. LED is OFF.</p>

Table 6 Single Color LED Display (cont'd)

Pin Name	Status
DUPCOL2/ DUPCOL1/ DUPCOL0	<p>These 3 pins have power on reset values on them. Samurai-6M/6MX (ADM6996M/MX) needs to consider these values to drive the correct value. If the power on reset value is value_power_on, then the display is as follows:</p> <ol style="list-style-type: none"> 1. First period: This period lasts 1.28 s for LED on test. Samurai-6M/6MX (ADM6996M/MX) drives ~value_power_on to open the LED. 2. Second period: This period lasts 0.48 s for LED off test. Samurai-6M/6MX (ADM6996M/MX) drives value_power_on to close the LED. 3. Normal Period: This period indicates the duplex/collision status. <ul style="list-style-type: none"> ~value_power_on = Port links up in the full-duplex mode. LED is ON. value_power_on = Port links down. LED flashes at 10 Hz. 0/1_B , Port links up and collision is detected. The LED flashes at 10 Hz. <p>If DUP_COL_SEP is enabled, the normal period changes its way to display.</p> <ul style="list-style-type: none"> ~value_power_on = Port links up in the duplex mode. LED is ON. value_power_on = Port links down or links up in the half-duplex mode. LED is OFF. 0/1_B , This value is cancelled. LED doesn't blink. <p>If DHCOL_LED_EN is enabled, the display in the normal period is as follows:</p> <p>DUPCOL0: 10m collision indicator.</p> <ul style="list-style-type: none"> 0/1_B , One of the ports links up in 10M half-duplex mode and detects a collision event. The LED flashes at 20 Hz. value_power_on = When the above event is not satisfied, the LED is OFF. <p>DUPCOL1: 100 m collision indicator.</p> <ul style="list-style-type: none"> 0/1_B , One of the ports links up in 100M half-duplex mode and detects a collision event. The LED flashes at 20 Hz. value_power_on = The above event is not satisfied. LED is OFF.
DUPCOL4/ DUPCOL3	<p>The behavior of these pins is the same as the LNKACT, except the normal period.</p> <p>Normal period: This period indicates the duplex/collision status.</p> <ul style="list-style-type: none"> ~value_power_on = Port links up in the full-duplex mode. LED is ON. value_power_on = Port links down. LED is OFF. 0/1_B , Port links up and collision is detected. The LED flashes at 10 Hz. <p>If DUP_COL_SEP is enabled, the normal period changes its way to display.</p> <ul style="list-style-type: none"> ~value_power_on = Port links up in the duplex mode. LED is ON. value_power_on = Port links down or links up in the half-duplex mode. LED is OFF. 0/1_B , This value is cancelled. LED doesn't blink.

3.1.12.2 Dual Color LED Display

Users should be careful that DUPCOL LED only supports the single color mode. The only difference between single and dual color for DUPCOL LED is the self-test time.

Table 7 Dual Color LED Display

Pin Name	Status
(LNKACT4, LDSPD4)/ (LNKACT3, LDSPD3) (LNKACT2, LDSPD2) (LNKACT1, LDSPD1) (LNKACT0, LDSPD0)	<p>First Period: Test LED on with green color. It lasts 1.28 s. 01_B , LED is on with green color.</p> <p>Second Period: Test LED on with yellow color. It lasts 1.28 s. 10_B , LED is on with yellow color.</p> <p>Third period: Test LED off. 00_B , LED is off.</p> <p>Normal Period: This period shows the status of the link and speed at the same time.</p> <p>00_B , Port links down. LED is off. 11_B , Port links down. LED is off. 01_B , Port links up in 100M. LED glows green. 10_B , Port links up in 10M. LED glows yellow. 0/1,1_B , Port links up in 100M and is receiving or transmitting. LED blinks with green color at 10 Hz. 0/1,0_B , Port links up in 10M and is receiving or transmitting. LED blinks with yellow color at 10 Hz.</p>
DUPCOL4/DUPCOL3/ DUPCOL2/DUPCOL1/ DUPCOL0	The behavior of these pins is the same as the single mode, except the self-test period. The LED on test period is 2.56 s instead of 1.28 s.

3.1.12.3 Circuit for Single LED Mode

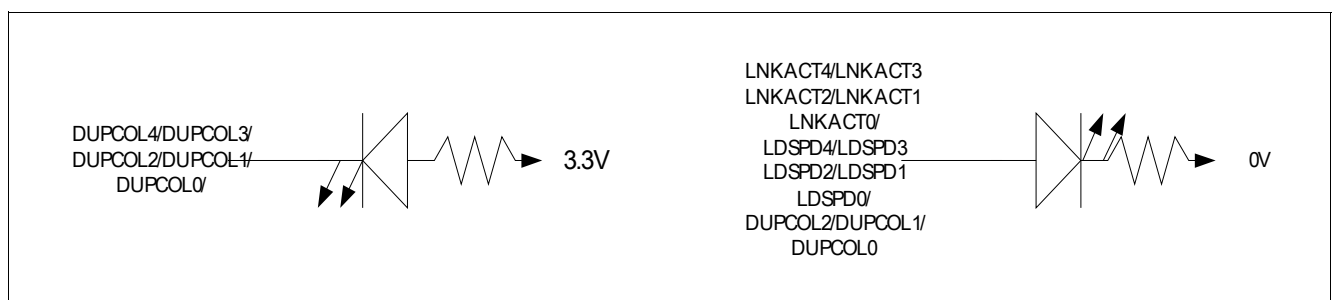

Figure 3 Circuit for Single Color LED Mode

3.1.12.4 Circuit for Dual LED Mode

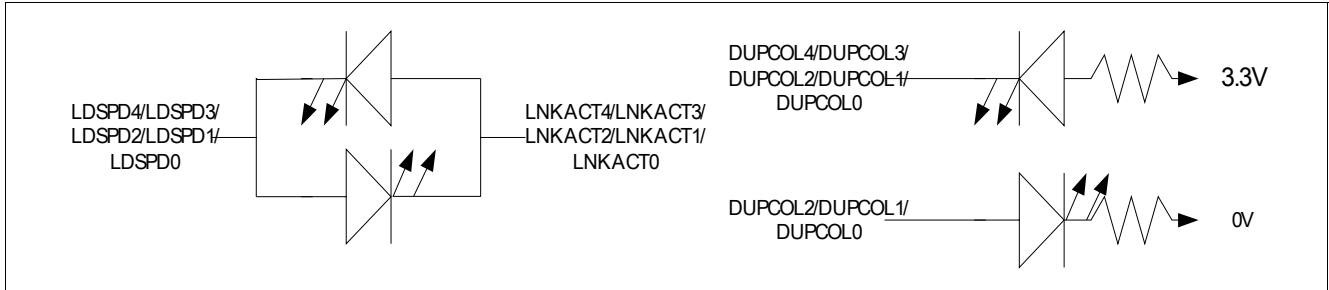

Figure 4 Circuit for Dual Color LED Mode

3.1.13 Packet Identification

Packets are classified to determine if they should be passed to the CPU port or another entity for special handling.

Table 8 Packet Identification

Packets Identified by Samurai-6M/6MX (ADM6996M/MX)	Comments
BPDU	The Ethernet destination address is 01 80 C2 00 00 00 _H .
PAUSE	The Ethernet destination address is 01 80 C2 00 00 01 _H . Ether-Type field is 8808 _H . OPCODE is 0001 _H .
SLOW	The Ethernet destination address is 01 80 C2 00 00 02 _H .
PAE	The Ethernet destination address is 01 80 C2 00 00 03 _H .
RESER_R0	The Ethernet destination address ranges between 01 80 C2 00 00 04 _H and 01 80 C2 00 00 0F _H .
RESER_R1	The Ethernet destination address ranges between 01 80 C2 00 00 10 _H and 01 80 C2 00 00 1F _H .
GXRP	The Ethernet destination address ranges between 01 80 C2 00 00 20 _H and 01 80 C2 00 00 22 _H .
RESER_R2	The Ethernet destination address ranges between 01 80 C2 00 00 23 _H and 01 80 C2 00 00 2F _H .
RESER_R3	The Ethernet destination address ranges between 01 80 C2 00 00 30 _H and 01 80 C2 00 00 FF _H .
RARP	The Ethernet destination address is FF FF FF FF FF FF _H and the Ether-Type field is 8035 _H .
ARP	The Ethernet destination address is FF FF FF FF FF FF _H and the Ether-Type field is 8036 _H .
IGMP_IP	The Ethernet destination address is 01 00 5E xx xx xx _H . Ether-Type field is 0800 _H (IP). IP Version is 4 and the Protocol field is 02 _H (IGMP).
MLD_IP	Ethernet destination address is 33 33 xx xx xx xx _H . The Ether-Type field is 0800 _H (IP). IP Version is 6 and the Protocol field is 3A _H (ICMP).
MLD_IPV6	Ethernet destination address is 33 33 xx xx xx xx _H . The Ether-Type field is 86DD _H (IP). IP Version is 6 and the Protocol field is 3A _H (ICMP).

Table 8 Packet Identification (cont'd)

Packets Identified by Samurai-6M/6MX (ADM6996M/MX)		Comments
Others	TYPE	The Ether-Type field matches one of the type filters.
	PROTOCOL	The Protocol field matches one of the protocol filters.
	TCPUDP	The TCP/UDP port number matches one of the TCP/UDP filters.
	MAC_CTRL	The Ether-Type field is 8808 _H , but OPCODE is not 0001 _H .

For learning purpose, Samurai-6M/6MX (ADM6996M/MX) sometimes divides Ethernet address into three groups.

Table 9 Packet Identification Groups

Packets Identified by Samurai-6M/6MX (ADM6996M/MX)	Comments
MULTICAST	The first bit of the Ethernet destination address is 1, but not all 1.
BROADCAST	The Ethernet destination address is FF FF FF FF FF FF _H .
UNICAST	The first bit of the Ethernet destination address is 0.

3.1.13.1 Span Packet

Samurai-6M/6MX (ADM6996M/MX) supports 4 Spanning Tree Port State (Disable, Blocking/Listening, Learning and Forwarding state) for every port to enable Spanning Tree Protocol function when co-operates with an external CPU. These port states are defined in **STPS** of EEPROM register 0013_H ~ 0018_H.

Samurai-6M/6MX (ADM6996M/MX) supports a function to specify a packet to be treated as a Span Packet. Beside Disable state, the Span Packets will not be dropped by Spanning Tree Port State settings.

Table 10 Span Packet

Packet Type	Description
BPDU/SLOW/PAE/RESER_R0/ RESER_R1/GXRP/RESER_R2/ RESER_R3	The span packet is determined in priority order by: <ol style="list-style-type: none"> Span bit defined in the Special TAG, when Span_Valid is set. Span bit defined in the learning table when there is a match for DA+FID. Span bit defined in the control table when there is a match for DA. Span bit in register 003E_H.
ARP/RARP	The span packet is determined in priority order by: <ol style="list-style-type: none"> Span bit defined in the Special TAG, when Span_Valid is set. Span bit in register 000D_H.
IGMP_IP/MLD_IP/MLD_IPV6	The span packet is determined in priority order by: <ol style="list-style-type: none"> Span bit defined in the Special TAG, when Span_Valid is set. Span bit in register 000C_H.
Others	The span packet is determined in priority order by: <ol style="list-style-type: none"> Span bit defined in the Special TAG, when Span_Valid is set. Span bit defined in the learning table when there is a match for DA+FID. If the first and second conditions are not satisfied, the frame is classified as non-span packets.

3.1.13.2 Management Packet

Samurai-6M/6MX (ADM6996M/MX) reserves some buffers for these packets, so they are not dropped because of traffic congestion. Management packets are never limited by the bandwidth control, stormed by the storming control, or dropped due to **Smart Discard** function.

Table 11 Management Packet

Packet Type	Description
BPDU/SLOW/PAE/RESER_R0/ RESER_R1/GXRP/RESER_R2/ RESER_R3	The management packet is determined in priority order by: <ol style="list-style-type: none"> 1. Management bit defined in the Special TAG, when Management_Valid is set. 2. Management bit defined in the learning table when there is a match for DA+FID. 3. Management bit defined in the control table when there is a match for DA. 4. Management bit in register 003E_H.
ARP/RARP	The management packet is determined in priority order by: <ol style="list-style-type: none"> 1. Management bit defined in the Special TAG, when Management_Valid is set. 2. Management bit in register 000D_H.
IGMP_IP/MLD_IP/MLD_IPV6	The management packet is determined in priority order by: <ol style="list-style-type: none"> 1. Management bit defined in the Special TAG, when Management_Valid is set. 2. Management bit in register 000C_H.
Others	The management packet is determined in priority order by: <ol style="list-style-type: none"> 1. Management bit defined in the Special TAG, when Management_Valid is set. 2. Management bit defined in the learning table when there is a match for DA+FID. If the first and second conditions are not satisfied, the frame is classified as non-management packets.

3.1.13.3 Cross_VLAN Packet

Cross-VLAN packets are defined to cross VLAN boundary or bypass the VLAN violation.

Table 12 Cross_VLAN Packet

Packet Type	Description
BPDU/SLOW/PAE/RESER_R0/ RESER_R1/GXRP/RESER_R2/ RESER_R3	The cross-VLAN packet is determined in priority order by: <ol style="list-style-type: none"> 1. Cross_VALN bit defined in the Special TAG, when Cross_VLAN_Valid is set. 2. Cross_VLAN bit defined in the learning table when there is a match for DA+FID. 3. Cross_VLAN bit defined in the control table when there is a match for DA. 4. Cross_VLAN bit in register 003E_H.
ARP/RARP	The cross_VLAN packet is determined in priority order by: <ol style="list-style-type: none"> 1. Cross_VLAN bit defined in the Special TAG, when Cross_VLAN_Valid is set. 2. Cross-VLAN bit in register 000D_H.

Table 12 Cross_VLAN Packet (cont'd)

Packet Type	Description
IGMP_IP/MLD_IP/MLD_IPV6	The cross_VLAN packet is determined in priority order by: <ol style="list-style-type: none"> 1. Cross-VLAN bit defined in the Special TAG, when Cross_VLAN_Valid is set. 2. Cross-VLAN bit in register 000C_H.
Others	The Cross_VLAN packet is determined in priority order by: <ol style="list-style-type: none"> 1. Cross_VLAN bit defined in the Special TAG, when Cross_VLAN_Valid is set. 2. Cross_VLAN bit defined in the learning table when there is a match for DA+FID.If the first and second conditions are not satisfied, the frame is classified as non-cross_VLAN packets.

3.1.14 Tagged VLAN or Port VLAN

The difference between two VLAN rules is the way to search the VLAN boundary. Users could enable “TAG Base VLAN” (see 0011_H, [TBV](#)) bit to instruct Samurai-6M/6MX (ADM6996M/MX) to operate in the Tagged VLAN mode.

3.1.14.1 VLAN Filters

Samurai-6M/6MX (ADM6996M/MX) supports 16 VLAN filters, each specifying a Valid bit, a TAG PRI, a VID, a FID, a Tagged Member, and a Member.

Table 13 VLAN Filters

VLAN Filter 0	VLAN_Valid	VLAN_PRI[2:0]	VID[11:0]	FID[3:0]	Tagged Member[5:0]	Member[5:0]
~						
VLAN Filter 15						

3.1.14.2 Port VLAN

Port VLANs are created by grouping individual physical ports together. In this mode, only 6 VLAN filters (VLAN filter 0 ~5) are used. By the time examining the received frame, the source port is used as an index to search the VLAN filter. If the source port is port 0, then Member in the filter 0 is the VLAN group that port 0 joins.

3.1.14.3 Tagged VLAN

Tagged VLAN is created with the aid of the VID in the packet or VID assigned by the source port. This VID is compared with 16 VIDs in the VLAN filters to check if any match exists. The Member in this matched filter is the VLAN boundary for the packet.

3.1.14.4 VID for Comparison and Carried through Samurai-6M/6MX (ADM6996M/MX)

VID for comparison and carried through Samurai-6M/6MX (ADM6996M/MX) (as egress VID) depends on the VLAN configuration.

VID0: The incoming packet is tagged with VID = 000_H. Enable “Replace VID0” (see 000A_H, [RVID0](#)) to replace the Null VID with PVID (see basic control registers) if necessary.

VID1: The incoming packet is tagged with VID = 001_H. Enable “Replace VID1” (see 000A_H, [RVID1](#)) to replace VID1 with PVID (see basic control registers) if necessary.

VIDFFF: The incoming packet is tagged with VID = FFF_H. Enable “Replace VIDFFF” (see 000A_H, [RVIDFFF](#)) to replace VIDFFF with PVID (see basic control registers) if necessary.

VLAN Security Samurai-6M/6MX (ADM6996M/MX) ignores packet's VID and always uses PVID to see if there is a match and transfers it to the output ports. Disables the "VLAN Security Disable" (See 0022_H, **VSD**) to achieve this goal.

Input Force No Tag when enabled (see 0020_H, **IFNTE**), Samurai-6M/6MX (ADM6996M/MX) assumes all the packets are untagged and PVID is used. Input Force No Tag and VLAN Security are different in some situations.

Table 14 VID Comparison

Parameter	Tagged Frame with VID = 12'hfff	Packet Transmitted Tagged
VLAN Security	The frame is recorded as a VLAN violation and discarded if VIDFFF is not replaced.	Output packets have only one VLAN tag.
Input Force No Tag	The frame is recognized as an untagged frame. PVID is carried with this packet to the output port.	Output packets may have double tags, because the packet is transmitted with an additional tag with PVID.

3.1.14.5 Admit Only VLAN-Tagged Packets

Samurai-6M/6MX (ADM6996M/MX) supports a function to check if the packet is VLAN-Tagged, and any packets received on that port that carries no VID (untagged packets or packets with VID = 0) are discarded and recorded as a VLAN violation. This feature is implemented by programming the "Admit Only VLAN-Tagged" (see 0027_H, **AOVTP**).

Samurai-6M/6MX (ADM6996M/MX) assumes all the packets are untagged in the "Input Force No Tag" mode and users should care that in this situation, "Admit Only VLAN Tagged" is of no effect.

3.1.14.6 VID Check

In Tagged VLAN, the VID for comparison must be contained in the VLAN filters, or the packet received on the port will be dropped and recorded as a VLAN violation. This feature is disabled by programming the "VID CHECK" bit to 0 (see 0026_H, **VC**) to forward these packets instead of dropping them.

3.1.14.7 FID and VLAN Boundary

In Samurai-6M/6MX (ADM6996M/MX), every incoming packet is associated with a FID group. Samurai-6M/6MX (ADM6996M/MX) searches the learning table for the FID + DA, FID + SA. VLAN boundary restricts the allowable destination ports.

Table 15 FID Search Algorithm

Port VLAN	The source port number is the VLAN filter index. We can find FID in this filter.		
Tagged VLAN	VID match	Fid is contained in the matched filter. We can find FID in this filter.	
	VID un-match	VID check	The frame is dropped.
VID uncheck		Default FID is the FID (see 000A _H , DFID). If users configure Samurai-6M/6MX (ADM6996M/MX) to back to port VLAN (see 0027 _H , BPV), we can find the FID in the same way as the Port VLAN. When this feature is enabled, VLAN filter 0 ~ 5 are for Port VLAN purpose and VLAN filter 6 ~15 are for VID comparison.	

Table 16 VLAN Boundary Search Algorithm

Port VLAN	The source port number is the VLAN filter index. We can find the boundary in this filter.
-----------	---

Table 16 VLAN Boundary Search Algorithm (cont'd)

Tagged VLAN	VID match	Member is contained in the matched filter. We can find the boundary in this filter	
	VID un-match	VID check	The frame is dropped.
		VID uncheck	Samurai-6M/6MX (ADM6996M/MX) uses Default VLAN Portmap as the boundary (see 003A _H , DVM). If users configure Samurai-6M/6MX (ADM6996M/MX) to “Back to Port VLAN” (see 0027 _H , BPV), we can back to find the boundary in the same way as the Port VLAN. When this feature is enabled, VLAN filter 0 ~ 5 are for Port VLAN purpose and VLAN filter 6 ~15 are for VID comparison.

3.1.14.8 Ingress Filter

If the source port is not contained in the VLAN boundary associated with the incoming packet, then this frame is dropped and recorded as a VLAN violation. This feature is disabled by setting the “Ingress Filter” (see 0021_H, **IFE**) bit to 0_B.

3.1.14.9 VLAN Violation

When packets are recorded as a VLAN violation packet, Samurai-6M/6MX (ADM6996M/MX) will drop them. The only way to ignore these violations is to classify these packets as cross_VLAN packets.

3.1.14.10 TXTAG Carried through Samurai-6M/6MX (ADM6996M/MX)

Each packet during receive is assigned 2-bit TXTAG value. This value is carried by Samurai-6M/6MX (ADM6996M/MX) to the output ports to help to determine if egress tagged is necessary.

Table 17 TXTAG Carried through Samurai-6M/6MX (ADM6996M/MX)

Packet Type	Description
BPDU/SLOW/PAE/RESER_R0/ RESER_R1/GXRP/RESER_R2/ RESER_R3	The TXTAG is determined in priority order by: 1. TXTAG in Special Tag with TXTAG_Valid enabled. 2. TXTAG in the learning table when there is a match for DA+FID in the learning table. 3. TXTAG in the control table when there is a match for DA in the control table. 4. TXTAG defined in register 003E _H .
ARP/RARP	The TXTAG is determined in priority order by: 1. TXTAG in Special Tag with TXTAG_Valid enabled. 2. TXTAG is defined in 000D _H .
IGMP_IP/MLD_IP/MLD_IPV6	The TXTAG is determined in priority order by: 1. TXTAG in Special Tag with TXTAG_Valid enabled. 2. TXTAG is defined in 000C _H .
Other	The TXTAG is determined in priority order by: 1. TXTAG in Special Tag with TXTAG_Valid enabled. 2. The DA + FID matches an entry in the learning table with TXTAG defined.If the first and second conditions are not satisfied, TXTAG is 2'b00.

3.1.14.11 Tagged Member Carried through Samurai-6M/6MX (ADM6996M/MX)

If the output port is a tagged port it is determined by the port or the VID. Ports in the tagged members should egress packets tagged.

First Way: New Transmit Tag Disable (see 0x000ah)

The "Output Packet Tagging" bit in the basic control registers determines the tagged members.

Second Way: New Transmit Tag Enable (see 0x000ah)

Port VLAN	The source port number is the VLAN filter index. We can find the tagged member in this filter.		
Tagged VLAN	VID match	Tagged members are contained in the matched VLAN filter. We can find the tagged members in this filter	
	VID un-match	VID check	The frame is dropped.
VID uncheck		Samurai-6M/6MX (ADM6996M/MX) uses the first way to determine the tagged members. If users configure Samurai-6M/6MX (ADM6996M/MX) to "Back to Port VLAN" (see 0027 _H , BPV), it can go back to find the tagged members in the same way as the Port VLAN.	

Users should note that when the Special Tag with Tagged Member Valid = 1_B is incoming, the Samurai-6M/6MX (ADM6996M/MX) always uses Tagged Member in the Special Tag as the Tagged Member.

3.1.14.12 Egress Tag Rule

On the receiving port, Samurai-6M/6MX (ADM6996M/MX) will attach each packet with the tagged members by the Ingress rule. When the packet reaches the destination port, Samurai-6M/6MX (ADM6996M/MX) will check if the destination port is a tagged member, if yes, the packet will be transmitted tagged.

Table 18 Egress Tag Result

Untagged packets are received (If Input Force No Tag is enabled, Samurai-6M/6MX (ADM6996M/MX) assumes all the received packets are untagged.)	Output port is in the tagged members carried with the packet.	TXTAG Description 00 _B , System Default Tag. Packets are transmitted tagged. 01 _B , Unmodified. Packets are transmitted untagged. 10 _B , Always Tagged. Packets are transmitted tagged. 11 _B , Always Untagged. Packets are transmitted untagged.
	Output port is not in the tagged members carried with the packet.	TXTAG Description 00 _B , System Default Tag. Packets are transmitted untagged. 01 _B , Unmodified. Packets are transmitted untagged. 10 _B , Always Tagged. Packets are transmitted tagged. 11 _B , Always Untagged. Packets are transmitted untagged.
	Output port is configured to operate in the bypass mode. See 002A _H .	TXTAG Description 00 _B , System Default Tag. Packets are transmitted untagged. 01 _B , Unmodified. Packets are transmitted untagged. 10 _B , Always Tagged. Packets are transmitted tagged. 11 _B , Always Untagged. Packets are transmitted untagged.

Table 18 Egress Tag Result (cont'd)

Tagged packets are received.	Output port is in the tagged members carried with the packet.	<p>TXTAG Description</p> <p>00_B , System Default Tag. Packets are transmitted tagged.</p> <p>01_B , Unmodified. Packets are transmitted tagged.</p> <p>10_B , Always Tagged. Packets are transmitted tagged.</p> <p>11_B , Always Untagged. Packets are transmitted untagged.</p>
	Output port is not in the tagged members carried with the packet.	<p>TXTAG Description</p> <p>00_B , System Default Tag. Packets are transmitted untagged.</p> <p>01_B , Unmodified. Packets are transmitted tagged.</p> <p>10_B , Always Tagged. Packets are transmitted tagged.</p> <p>11_B , Always Untagged. Packets are transmitted untagged.</p>
	Output port is configured to operate in the bypass mode. See 002A _H .	<p>TXTAG Description</p> <p>00_B , System Default Tag. Packets are transmitted tagged.</p> <p>01_B , Unmodified. Packets are transmitted tagged.</p> <p>10_B , Always Tagged. Packets are transmitted tagged.</p> <p>11_B , Always Untagged. Packets are transmitted untagged.</p>

3.1.14.13 Tagged PRI Carried through Samurai-6M/6MX (ADM6996M/MX)

Table 19 Tagged PRI Carried

Untagged packets are received (If Input Force No Tag is enabled, Samurai-6M/6MX (ADM6996M/MX) assumes all the received packets are untagged.)	Port VLAN	[Change Priority Enable, Change Rule] (see 000A _H , PCE&PCR)	
	Tagged VLAN	VID unmatch	Reverse PRI
		VID match	[Change Priority Enable, Change Rule] (see 000A _H , PCE&PCR)
		0x _B , Reverse PRI.	
		10 _B , VLAN_PRI field in the matched VLAN filter.	
		11 _B , Reverse PRI	

Table 19 Tagged PRI Carried (cont'd)

Tagged packets are received.	Port VLAN	[Change Priority Enable, Change Rule] (see 000A _H , PCE&PCR) 0 _B , Tagged PRI = The 3-bit user priority in the tag header. 10 _B , VLAN_PRI field in the matched VLAN filter. 11 _B , Reverse PRI	
	Tagged VLAN	VID un-match	Change Priority Enable (see 000A _H , PCE) 0 _B , Tagged PRI = The 3-bit user priority in the tag header. 1 _B , Reverse PRI.
		VID match	[Change Priority Enable, Change Rule] (see 000A _H , PCE&PCR) 0 _B , Tagged PRI = The 3-bit user priority in the tag header. 10 _B , VLAN_PRI field in the matched VLAN filter. 11 _B , Reverse PRI

Reserve PRI is reversed from the priority queue the packet is switched through.

Compare = queue, queue, queue, queue} XOR VLAN Priority MAP in 000E_H.

Then we get Tagged PRI.

Compare Tagged PRI

XXXX_XXX0_B = 000_B

XXXX_XX01_B = 001_B

XXXX_X011_B = 010_B

XXXX_0111_B = 011_B

XXX0_1111_B = 100_B

XX01_1111_B = 101_B

X011_1111_B = 110_B

0111_1111_B = 111_B

1111_1111_B = 000_B

3.1.14.14 CFI Carried through Samurai-6M/6MX (ADM6996M/MX)

Table 20 CFI Carried

CFI Carried	
Untagged frames received (If Input Force No Tag is enabled, Samurai-6M/6MX (ADM6996M/MX) assumes all the received packets are untagged.)	CFI Carried = 0 _B
Tagged frame received	CFI Carried = Original CFI in the tag header.

3.1.14.15 Egress TAG

Egress tag contains Egress PRI, Egress CFI, and Egress VID. When packets are transmitted tagged, this egress tag associated with Ethernet-Type = 8100_H is inserted following the Ethernet source address.

Egress PRI: Egress PRI is Tagged PRI carried through Samurai-6M/6MX (ADM6996M/MX) from the source port.

Egress CFI: Egress CFI is CFI carried through Samurai-6M/6MX (ADM6996M/MX) from the source port.

Egress VID: Egress VID is VID carried through Samurai-6M/6MX (ADM6996M/MX) from the source port.

3.1.15 Priority Queue

Samurai-6M/6MX (ADM6996M/MX) supports 4 priority queues and each is assigned a weight.

Table 21 Priority Queue

Queue	Weight
Queue 0	Weight = 1
Queue 1	Weight = "Queue 1 Weight" bits in 0025 _H
Queue 2	Weight = "Queue 2 Weight" bits in 0026 _H
Queue 3	Weight = "Queue 3 Weight" bits in 0027 _H

3.1.15.1 System PRI

The system PRI is determined in the order as follows:

- (DA+FID) was found in the learning table, then LRN_PRI field (when LRN_PRIEN is set) in this entry indicates the priority queue.
- Port PRI in basic control register indicates the priority queue, when Port_PRIEN is enabled on that port.
- The user priority field in the tag header is used for a tagged packet ("Input Force No Tag" doesn't effect Samurai-6M/6MX (ADM6996M/MX) to extract the PRI in the tag header), when "VLAN Priority" is enabled. The user priority in the tag header is a 3 bits field, Samurai-6M/6MX (ADM6996M/MX) uses "VLAN Priority MAP" to map the priority queue.
- For IP packets with no tag header, IP PRI is used when "Service Priority" (see 001F_H) is enabled. Even for a tagged packet with IP header, we can set "IP over VLAN" (see basic control registers) bit to 1 to force using IP PRI. Three kinds of IP PRI are available.
 - For IPV6 packets with IP Version = 6_H, the most significant 6 bits of the traffic class in the IPV6 header is used to map the priority queue by the service mapping registers.
 - For IPV4 packets with IP Version = 4_H, the most significant 3 bits of the TOS field in the IPV4 header is used to map the priority queue by the TOS Priority Map register.
 - If "TOS Using" (see 000A_H) is disabled, even for IPV4 packets, Samurai-6M/6MX (ADM6996M/MX) uses the most significant 6 bits of the TOS field to map the priority queue by the service mapping registers.
- If the packet matches the TCP/UDP filters, the PRI associated with this filter indicates the priority queue when "TCP/UDP PRIEN" is set to 1 (see 0098_H). Users could enable "TCPUDP over IP" to force using the TCPUDP PRI when there is a match.

3.1.15.2 Queue Assigned

Table 22 Queue Assigned

Packets Identified by Samurai-6M/6MX (ADM6996M/MX)	The Order of Priority Assigned
BPDU/SLOW/PAE/RESER_R0/ RESER_R1/GXRP/RESER_R2/ RESER_R3	<ol style="list-style-type: none"> The PRI field with PRI_Valid = 1 in the Special TAG indicates the priority queue. If (DA+FID) matches an entry in the learning table, then LRN_PRI field with LRN_PRIEN enabled in this entry indicates the priority queue. Use PRI in 003D_H to indicate the queue the frame was switched.
ARP/RARP	<ol style="list-style-type: none"> The PRI field with PRI_Valid = 1 in the Special TAG indicates the priority queue. Use PRI in 000D_H to indicate the priority queue when enabled. Use System PRI.

Table 22 Queue Assigned (cont'd)

Packets Identified by Samurai-6M/6MX (ADM6996M/MX)	The Order of Priority Assigned
IGMP_IP/MLD_IP/MLD_IPV6	<ol style="list-style-type: none"> 1. The PRI field with PRI_Valid = 1 in the Special TAG indicates the priority queue. 2. Use PRI in 000C_H to indicate the priority queue when enabled. 3. Use System PRI.
Others	<ol style="list-style-type: none"> 1. The PRI field with PRI_Valid = 1 in the Special TAG indicates the priority queue. 2. Use System PRI.

3.1.15.3 Configure Samurai QoS Function

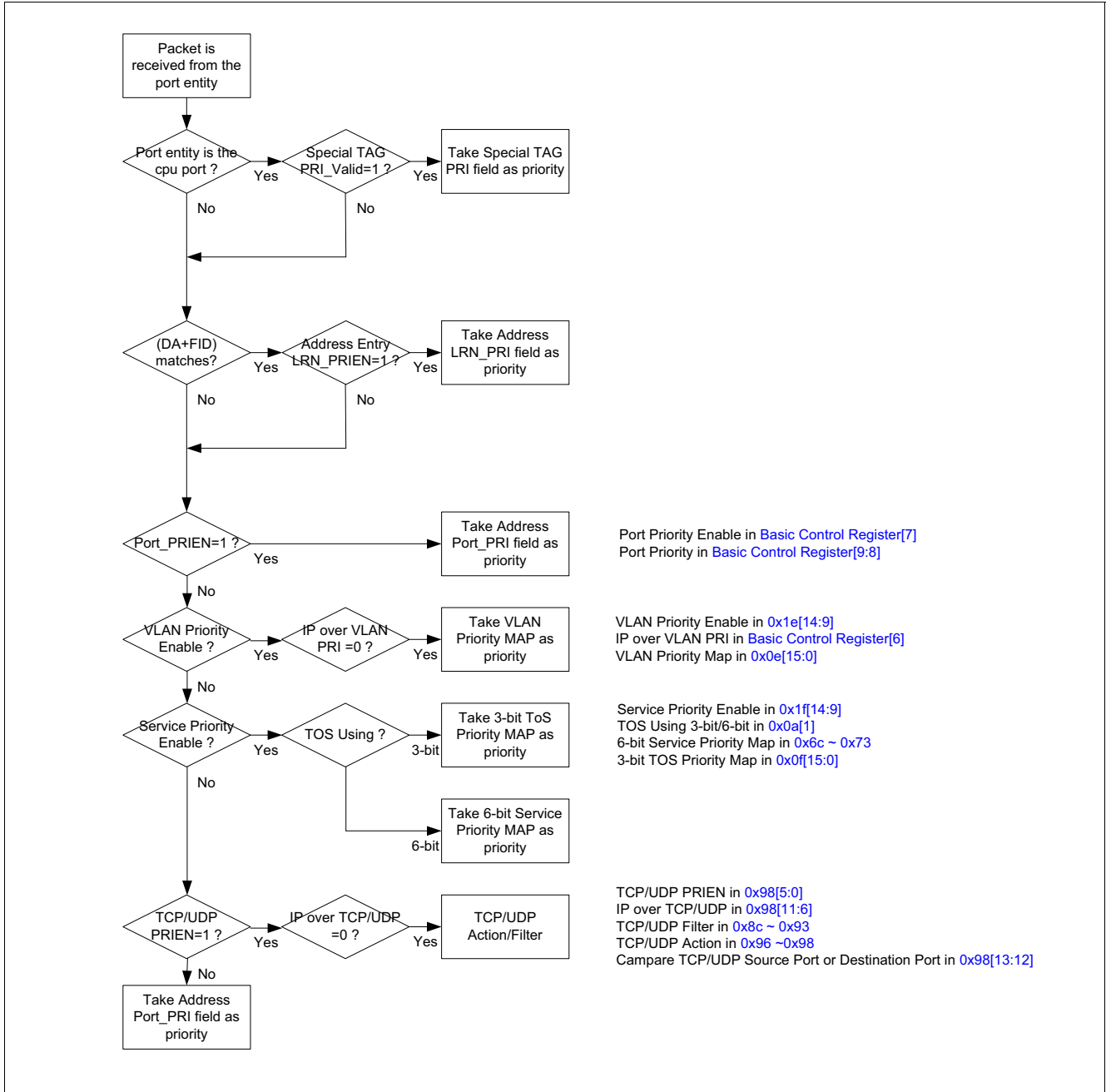

Figure 5 To Configure Samurai QoS function

3.1.16 Address Learning

Samurai-6M/6MX (ADM6996M/MX) provides two ways to create the entry in the address table: dynamic learning and manual learning. A four-way hash algorithm is implemented to allow the maximum of 4 different addresses with the same hash key to be stored at the same time. Up to 2k entries can be created and all entries are stored in the internal SSRAM. Samurai-6M/6MX (ADM6996M/MX) searches the learning table for the SA+FID of the incoming packet or the instruction from CPU. When both fields (a single SA may exist in different FID) are matched, there is a match.

3.1.16.1 Dynamic Learning

The Samurai-6M/6MX (ADM6996M/MX) searches for SA and FID of an incoming packet in the address table and takes dynamic learning action as follows:

1. If (SA+FID) was not found in the learning table, create a new entry with SA, FID, and the incoming port.
2. If (SA+FID) was found in the learning table, and the incoming port and the Portmap doesn't match, create a new entry with SA, FID, and the incoming port.

Dynamic learning will be disabled in the following condition:

1. Security violation exists on the port.
2. VLAN violation exists on the port.
3. The packet is a PAUSE packet.
4. The number of the addresses that port has learned has reached its maximum.
5. The port disables its learning function (see extended control registers).
6. The packet is an illegal packet (too long, too short or FCS error).
7. A packet with Special Tag is received and the LRN bit is 0 and LRN_Valid = 1_B.
8. The port is in the Disabled state in the Spanning Tree Protocol.
9. The port is in the Blocking/Listening state in the Spanning Tree Protocol.
10. All the four entries in the same hash address are occupied and all of them are static addresses.

3.1.16.2 Manual Learning

The Samurai-6M/6MX (ADM6996M/MX) implements the manual learning through the CPU's help. The CPU can create or remove any entry in the address table. Each entry could be static. "Static" means the entry will not be aged forever. When the entry is static, then the definition in some fields is modified to make Samurai-6M/6MX (ADM6996M/MX) work more flexibly.

3.1.16.3 Learning Table

3.1.16.3.1 Entry Format in the Learning Table

69	68	67	66 ... 58	57 ... 52	51 ... 48	47 ... 0
Bad	Info_Type	Occupy	Info_Ctrl/Age Timer	Portmap	FID	Address

Field	Description
Bad	The entry is marked to show if it is failed during the learning table memory bist time. 0 _B , Don't fail 1 _B , Fail
Info_Type	Static Address. 0 _B , The entry is not static 1 _B , The entry is static
Occupy	The entry is marked to show the status if the entry is occupied. 0 _B , Don't occupy 1 _B , Occupy

Function Description

Field	Description	
Info_Ctrl/Age Timer	Info_Ctrl is used when the entry is static.	
	Bit	Description
	8	Source Intrusion 0 _B , It isn't a violated source address 1 _B , It is a violated source address
	7	Span 0 _B , Not a span packet 1 _B , A span packet
	6	Management 0 _B , Not a management packet 1 _B , A management packet
	5	Cross_VLAN 0 = Not a cross_VLAN packet. 1 = A cross_VLAN packet.
	4:3	TXTAG It is used as an option for inserting Tag on the transmission port. 00 _B , System Default Tag 01 _B , Unmodified 10 _B , Always Tagged 11 _B , Always Untagged
	2	LRN_PRIEN 0 _B , LRN_PRI is not used 1 _B , LRN_PRI is used
	1:0	LRN_PRI It identifies the address priority. 00 _B , Queue 0 01 _B , Queue 1 10 _B , Queue 2 11 _B , Queue 3
		Age Timer is used when the entry is not static.
	Bit	Description
	8:0	Age Timer This timer is used to control the ageing time.
Portmap	The field is used as the output ports associated with the FID+MAC Address.	
FID	The field is used as the FID group associated with the MAC address.	
Address	The MAC Address in the learning table.	

3.1.16.3.2 The Registers Accessing the Learning Table

12 registers are provided by Samurai-6M/6MX (ADM6996M/MX) to support access to the address table. These 12 registers are Address Table Control Register 0 ~ 5 and Address Table Status Register 0 ~ 5 in 011A_H ~ 0125_H.

Table 23 Control Register Description for Accessing the Address Table

Command	Access Control	Info_Type	Info_Ctrl/Age Timer	Portmap	FID	Address
Control 5[6:4]	Control 5[3:0]	Control 4[12]	Control 4[8:0]	Control 3[9:4]	Control 3[3:0]	{Control 2, Control 1, Control 0}

Function Description

The Address, FID, Portmap, Info_Ctrl/Age Timer and Info_Type in the Control Register have the same meaning as those in the entry format. The Command and Access Control are described as follows:

Table 24 Description for Command and Access Control

Command	Access Control	Description
000 _B	0111 _B	Create a new address
000 _B	1111 _B	Overwrite an existed address
001 _B	1111 _B	Erase an existed address
010 _B	0000 _B	Search an empty address
010 _B	1001 _B	Search by the port in the Output Port field
010 _B	1010 _B	Search by the forwarding group specified in the Forwarding Group field
010 _B	1100 _B	Search by the address specified in the MAC Address field
010 _B	1110 _B	Search by the address and forwarding group
010 _B	1101 _B	Search by the address and output port
010 _B	1011 _B	Search by the forwarding group and the output port
010 _B	1111 _B	Search by the address, the forwarding group and the output port
011 _B	0100 _B	Initial to location by the address field
011 _B	0000 _B	Initial to the first address

Table 25 Status Register Description

Busy	Result	Bad	Occupy	Info_Type	Info_Ctrl/ Age_Time	Portmap	FID	Address
Status 5 [15]	Status 5 [14:12]	Status 5 [2]	Status 5 [1]	Status 5 [0]	Status 4 [8:0]	Status 3 [9:4]	Status 3 [3:0]	{Status 2, Status 1, Status 0}

Table 26 Description for the Status Register

Address	If the search operation is successful, the switch will return the MAC address in this field. If the search fails, this field doesn't mean anything.
FID	If the search operation is successful, the switch will return FID in the matched entry.
Portmap	If the search operation is successful, the switch will return Portmap in the entry.
Info_Ctrl/ Age Time	If the search operation is successful, the switch will return Info_Ctrl/Age Timer in the entry.
Info_Type	If the search operation is successful, the switch will return Info_Type in the entry
Occupy	If the search operation is successful, the switch will return Occupy in the entry
Bad	If the search operation is successful, the switch will return Bad in the entry

Table 26 Description for the Status Register (cont'd)

Result	<p>This field tells us the status for not only the search operation but also the creating operation.</p> <p>000_B , Command OK</p> <p>001_B , All Entry Used. This result happens only for the create operation. Samurai-6M/6MX (ADM6996M/MX) uses the 4-way address lookup engine so it allows 4 different addresses stored at each hash location. If these 4 entries are all static, then CPU will not successfully create 5 different addresses hashed to the same location and 001 will be returned. The only way to create 5 different addresses is to remove one of earlier addresses.</p> <p>101_B , Command Error</p>
Busy	<p>This bit indicates if the table engine for access is available.</p> <p>1_B , The engine is busy and it will not accept the command from the CPU.</p> <p>0_B , The engine is available.</p>

3.1.16.3.3 Rules to Access the Learning Table

1. Check the Busy Bit in the status register to see if the access engine is available. If the engine is busy, wait until the engine is free. If the engine is available, go to the following step.
2. Write the MAC address[15:0] into the control register 0.
3. Write the MAC address[31:16] into the control register 1.
4. Write the MAC address[47:32] into the control register 2.
5. Write the Portmap and FID into the control register 3.
6. Write the Info_Ctrl/Age Timer and Info_Type into the control register 4.
7. Write the Access Control and Command into the control register 5 to define the operation.
8. Wait for the engine to complete (Check the Busy Bit).
9. Read the desired result returned in the status register.

Note: Before a new search starts, the CPU should execute the "Initial command" to initial the search pointer. The search engine could search the aim from the top to the bottom. The search engine has an ability to move the pointer to the associated location automatically (The result will be returned). Because more than one entry may match the searching condition (by port, by address, etc.) at the same time, the CPU should continue to restart the search engine until the Command Result = Entry Not is found to confirm that no other matching entries exist and at this time a new search can be started.

3.1.16.3.4 Example

Example	Rule
The user needs Samurai-6M/6MX (ADM6996M/MX) to forward the specified unicast packet (DA = 0012-3456-789A _H and FID = 2) to port 3 forever.	<ol style="list-style-type: none"> 1. Check the Busy bit. If Busy = 0_B, go to the next step. If Busy = 1_B, wait. 2. Write 789A_H into control register 0. 3. Write 3456_H into control register 1. 4. Write 0012_H into control register 2. 5. Write 0082_H into control register 3. 6. Write 1000_H into control register 4. 7. Write 0007_H into control register 5. 8. Read the status register 5 to check the busy bit. If Busy = 0_B, check the Command Result to see if the create operation is successful. If Busy = 1_B, wait
The user needs Samurai-6M/6MX (ADM6996M/MX) to forward the specified multicast packet (DA = 0123-4567-89AB _H and FID = 3) to port 0, and port 1 both. This address could be aged.	<ol style="list-style-type: none"> 1. Check the Busy bit. If Busy = 0_B, go to the next step. If Busy = 1_B, wait. 2. Write 89AB_H into control register 0. 3. Write 3456_H into control register 1. 4. Write 0123_H into control register 2. 5. Write 0033_H into control register 3. 6. Write 0000_H into control register 4. 7. Write 0007_H into control register 5. 8. Read the status register 5 to check the busy bit. If Busy = 0_B, check the Command Result to see if the create operation is successful. If Busy = 1_B, wait
The user wants to know how many stations attached to port 4	<ol style="list-style-type: none"> 1. Check the Busy bit. If Busy = 0_B, go to the next step. If Busy = 1_B, wait. 2. Write 0030_H into control register 5 to initial the search pointer to the first address. 3. Wait until the Busy bit changes to 0_B. 4. Write 0100_H into the control register 3. 5. Write 0029_H into the control register 5 to start the operation of the search by port. 6. Read the status register 5 to check the busy bit. If Busy = 0_B, check the Command Result to see if the search operation is successful (the Mac address attached to port 4 could be derived from the MAC address in the status register). If Busy = 1_B, wait for completion. 7. If Command Result = "Command OK", it means some other MAC addresses attached to port 4 may exist. We should restart the "Search by port" command again to let the search engine look after another addresses. 8. If the Command Result = "Entry Not Found", it means no other addresses attached to port 4 exist.

3.1.17 Address Aging

Samurai-6M/6MX (ADM6996M/MX) maintains an age timer for each address. The aging timer is reset to 0 when the packet is received. When aging time counts up to 300 seconds, it means that station didn't transmit packets in this period and the address can be removed from the table. This could help to prevent a station which leaves the network and occupies a table space for a long time. Aging function can be disabled from the EEPROM (see extend control registers) and if the address is static, then Samurai-6M/6MX (ADM6996M/MX) will not age it out either. The default aging timer is 300 seconds. User could change Aging Timer Select (0011_H, [ATS](#)) to shorten the aging time.

3.1.18 Hardware Based IGMP Snooping

Samurai-6M/6MX (ADM6996M/MX) supports IGMP v1/v2 Snooping without any software effort. Samurai-6M/6MX (ADM6996M/MX) will monitor the IGMP traffic and update its embedded IGMP membership table if the hardware

based IGMP snooping function is enabled. IP multicast frames can be forwarded according to the Port-Map information of the membership table. The data of the membership can also be accessed by the CPU via SDC/SDIO interface. The following registers could be used to configure the IGMP Snooping behavior.

1. EEPROM register 00B_H bit [13:12], Additional Snooping Control register.ports.
2. EEPROM register 00B_H bit [2], Source Violation Over Snooping.
3. EEPROM register 00B_H bit [1], Source Violation Over Default.
4. EEPROM register 00C_H bit [13:6], various Snooping Control registers.
5. EEPROM register 00C_H bit [2], Hardware IGMP Packet Ignore CPU Port.
6. EEPROM register 00C_H bit [1], Hardware IGMP Snooping Enable.
7. EEPROM register 00C_H bit [0], Hardware IGMP Default Router Enable.
8. EEPROM register 00D_H bit [14], IP Multicast Packet Treated as Cross VLAN packet.
9. EEPROM register 01B_H bit [14:9], Multicast Port-Map.
10. EEPROM register 03F_H bit [15:8], Query Interval.
11. EEPROM register 03F_H bit [7:6], Robust Variable.
12. EEPROM register 03F_H bit [5:0], Default Router Port-Map.

3.1.18.1 Entry Format of IGMP Membership Table

57	56	55 ... 48	47 ... 42	41 ... 30	29	28... 23	22 ... 0
Bad	Occupy	Reserved	Reserved	Reserved	Reserved	Portmap	Group ID

Field	Description
Bad	The entry is marked to show if it is failed during the memory BIST time of IGMP membership table. 0 _B , Doesn't fail 1 _B , Fail
Occupy	The entry is marked to show the status if the entry is occupied. 0 _B , Empty Entry 1 _B , Occupied Entry
Reserved	Reserved. Ignore the content in reading and fill in 0 in writing.
Reserved	Reserved. Ignore the content in reading and fill in 0 in writing.
Reserved	Reserved. Ignore the content in reading and fill in 0 in writing.
Reserved	Reserved. Ignore the content in reading and fill in 0 in writing.
Portmap	This flag is used to denote whether the port is the member of this Group or not. 0 _B , The port is not the member of this Group. 1 _B , The port is the member of this Group.
Group ID	IP Multicast Group ID.

3.1.18.2 The Registers Accessing the IGMP Membership Table

The registers for accessing the IGMP membership table are the same with accessing MAC address filtering table, but the data format are re-defined as below.

Table 27 Control Register Description for Accessing the IGMP Membership Table

Command	Entry Address	Entry Data
Control 5[6:4]	Control 4[4:0]	{Control 3[9:0], Control 2, Control 1, Control 0}

The Command used to access IGMP membership table is defined as below.:

Table 28 Description for Command and Access Control

Command	Description
100 _B	Write data into internal IGMP table
101 _B	Read data from internal IGMP table

Table 29 Entry Format of IGMP Membership Table

Busy	Result	Entry Address	Entry Data
Status 5[15]	Status 5[14:12]	Status 4[4:0]	{Status 3[9:0], Status 2, Status 1, Status 0}

3.1.18.3 IGMP Snooping Introduction

IGMP snooping is a feature that allows the switch to “listen in” on the IGMP conversation between hosts and routers. When a switch hears an IGMP report from a host for a given multicast group, the switch adds the host's port number to the GDA (Group Destination Addresses) list for that group. And, when the switch hears an IGMP leave, it removes the host's port from the Multicast table entry.

Multicast Address

1. Multicast IP addresses are Class D IP addresses. Therefore, all IP addresses from 224.0.0.0 to 239.255.255.255 are multicast IP addresses. They are also referred to as Group Destination Addresses (GDA).

2. For each GDA there is an associated MAC address. This MAC address is formed by 01-00-5e, followed by the last 23 bits of the GDA translated in hex. Therefore:

- 230.20.20.20 corresponds to MAC 01-00-5e-14-14-14
- 224.10.10.10 corresponds to MAC 01-00-5e-0a-0a-0a

Consequently, this is not a one-to-one mapping, but a one-to-many mapping:

- 224.10.10.10 corresponds to MAC 01-00-5e-0a-0a-0a
- 226.10.10.10 corresponds to MAC 01-00-5e-0a-0a-0a, as well

3. Some Multicast IP addresses are reserved for special use. For example:

- 224.0.0.1 - All multicast-capable hosts.
- 224.0.0.2 - All multicast-capable routers
- 224.0.0.5 and 224.0.0.6 is used by: Open Shortest Path First (OSPF).

In general, addresses from 224.0.0.1 to 224.0.0.255 are reserved and used by various protocols.

IGMP

IGMP is a standard defined in RFC1112 for IGMPv1 and in RFC2236 for IGMPv2. It specifies how a host can register a router to receive specific multicast traffic.

IGMPv1

- **Membership Query** are issued by router at regular intervals to check whether there is still a host interested in the GDA in that segment.

Table 30 IPV4/IGMP/General Query

DA 01005e000001	SA 6 bytes	Type 16'h0800	Ver 4'h4	Len 4 bits	TOS 1 byte	Unused 7 bytes	Protocol 8'h02	Unused 6 bytes	DIP 224.0.0.1
Unused (Len*4-20) bytes	TP 8'h11	Unused 3 bytes	GA 32'b0						

Function Description

- **Membership Report** is issued by hosts that want to receive a specific multicast group (GDA). Host membership reports are issued either unsolicited (when the host wants to receive GDA traffic first) or in response to a membership query.

Table 31 IPV4/IGMP/V1 Report

DA 01005exxxxxx	SA 6 bytes	Type 16'h0800	Ver 4'h4	Len 4 bits	TOS 1 byte	Unused 7 bytes	Protocol 8'h02	Unused 6 bytes	DIP 4 bytes
Unused (Len*4-20) bytes	TP 8'h12	Unused 3 bytes	GA 4 bytes						

Host membership queries are sent by router to the all multicast address: 224.0.0.1. These queries use 0.0.0.0 in the IGMP GDA field. A host for each group must respond to that query or the router will stop forwarding the traffic for that GDA to that segment (after 3 attempts). The router simply keeps a multicast routing entry for each source and links it to a list of outgoing interfaces (interface from where the IGMP report came). After three IGMP query attempts with no answer, this interface is erased from outgoing interface list for all entries linked to that GDA.

Note: IGMPv1 has no leave mechanism. If a host no longer wants to receive the traffic, it simply quits. If it is the last, the router will not have any answers to its query and will delete the GDA for that subnet.

IGMPv2

- Membership Query

Table 32 IPV4/IGMP/General Query

DA 01005e000001	SA 6 bytes	Type 16'h0800	Ver 4'h4	Len 4 bits	TOS 1 byte	Unused 7 bytes	Protocol 8'h02	Unused 6 bytes	DIP 224.0.0.1
Unused (Len*4-20) bytes	TP 8'h11	Unused 3 bytes	GA 32'b0						

- IGMPv1 Membership Report

Table 33 IPV4/IGMP/V1 Report

DA 01005exxxxxx	SA 6 bytes	Type 16'h0800	Ver 4'h4	Len 4 bits	TOS 1 byte	Unused 7 bytes	Protocol 8'h02	Unused 6 bytes	DIP 4 bytes
Unused (Len*4-20) bytes	TP 8'h12	Unused 3 bytes	GA 4 bytes						

- IGMPv2 Membership Report

Table 34 IPV4/IGMP/V2 Report

DA 01005exxxxxx	SA 6 bytes	Type 16'h0800	Ver 4'h4	Len 4 bits	TOS 1 byte	Unused 7 bytes	Protocol 8'h02	Unused 6 bytes	DIP 4 bytes
Unused (Len*4-20) bytes	TP 8'h16	Unused 3 bytes	GA 4 bytes						

- **Leave Group** when a host wants to leave a group, it should send a Leave Group IGMP message to destination 224.0.0.2 (instead of leaving silently like in IGMPv1)

Table 35 IPV4/IGMP/V2 Leave

DA 01005000002	SA 6 bytes	Type 16'h0800	Ver 4'h4	Len 4 bits	TOS 1 byte	Unused 7 bytes	Protocol 8'h02	Unused 6 bytes	DIP 224.0.0.2
Unused (Len*4-20) bytes	TP 8'h17	Unused 3 bytes	GA 4 bytes						

- **Group-specific Query** a router can now send a group-specific query by sending a Membership Query to the group GDA instead of sending it to 0.0.0.0

Table 36 IPV4/IGMP/Group-Specific Query

DA 01005exxxxxx	SA 6 bytes	Type 16'h0800	Ver 4'h4	Len 4 bits	TOS 1 byte	Unused 7 bytes	Protocol 8'h02	Unused 6 bytes	DIP 4 bytes
Unused (Len*4-20) bytes	TP 8'h11	Unused 3 bytes	GA 4 bytes						

Learning the Router Port

The switch listens to the following messages in order to detect router ports with IGMP snooping

- IGMP Membership query send to 01-00-5e-00-00-01

Once a router port is detected, it is added to the port list of all GDAs in that VLAN.

[Hardware IGMP Snooping]

1. Enable Hardware IGMP Snooping, set EEPROM register $0C_H[1]=1$
2. Hardware IGMP Default Router

- If EEPROM register $0C_H[0]=0$, Samurai will learn the router port automatically.

Note: The presence of the router port is configured by Query Interval (EEPROM register $3F_H[15:8]$) defined as the length of time that must pass before the Router Port decides there is no longer another multicast router which should be the querier.

- If EEPROM register $0C_H[0]=1$, Samurai will learn the router port according to the Default Router Port-map.
- If EEPROM register $3F_H[5:0]$, Default Router Port-map

Note: The router port always exists even no IGMP query is received. The group membership is maintained by Robust Variable (EEPROM register $3F_H[7:6]$) defined as the amount of query that must pass before the Default Router decides there are no members of a group on a network.

Joining a Group with IGMP Snooping

Below are two joining scenarios.

Scenario A: Host A is the first host to join a group in the segment.

- Host A sends an unsolicited IGMP Membership report.
- The switch intercepts the IGMP membership report that sent by the host that wanted to join the group.
- The switch creates a multicast entry for that group and links it to the port on which it has received the report and to all router ports.
- The switch forwards the IGMP report on to all router ports. This is so that the router will also receive the IGMP report and will update its multicast routing table accordingly.

[Hardware IGMP Snooping]

Samurai supports 32 IGMP membership table. Samurai will maintain IGMP membership table according to IGMPv1/v2 protocol. If 32 IGMP membership table is full, the later incoming IGMP packets will follow “Multicast Port-map”.

User can use Address Table Control Register command and Address Table Status Register command to access 32 IGMP membership table.

Table 37 IGMP Membership Table

Address Table Control 0	EEPROM register 11A _H	Address Table Status 0	EEPROM register 120 _H
Address Table Control 1	EEPROM register 11B _H	Address Table Status 1	EEPROM register 121 _H
Address Table Control 2	EEPROM register 11C _H	Address Table Status 2	EEPROM register 122 _H
Address Table Control 3	EEPROM register 11D _H	Address Table Status 3	EEPROM register 123 _H
Address Table Control 4	EEPROM register 11E _H	Address Table Status 4	EEPROM register 124 _H
Address Table Control 5	EEPROM register 11F _H	Address Table Status 5	EEPROM register 125 _H

- IGMP membership table Read Command
 - (1) Check the **Busy** Bit in the **Status Register 5 [15]** to see if the access engine is available. If **Busy = 1_B**, wait until the engine is free. If **Busy = 0_B**, go to the following step.
 - (2) Write **Control Register 4 [4:0]** to assign the entry numbers you want to access.
 - (3) Write **Control Register 5 [6:4] = 101_B** to start the operation of Read command.
 - (4) Read the **Busy Bit** in the **Status Register 5 [15]** to see if the operation is successful. If **Busy = 1_B**, wait until the operation is completed. If **Busy = 0_B**, read **Status Register 5 ~ 0** to get the IGMP membership table entry.
- IGMP membership table Write Command
 - (1) Check the **Busy** Bit in the **Status Register 5 [15]** to see if the access engine is available. If **Busy = 1_B**, wait until the engine is free. If **Busy = 0_B**, go to the following step.
 - (2) Write **Control Register 0 ~ 4** to assign the entry numbers you want to access.
 - (3) Write **Control Register 5 [6:4] = 100_B** to start the operation of Write command.
 - (4) Read the **Busy** Bit in the **Status Register 5 [15]** to see if the operation is successful. If **Busy = 1_B**, wait until the operation is completed. If **Busy = 0_B**, read **Status Register 5 ~ 0** to get the IGMP membership table entry.

3.1.19 Source Violation

Source violation is defined in Samurai-6M/6MX (ADM6996M/MX) to support flexible security modes. See Security Option in the EEPROM Basic Register and the Src_Violation bit in the Learning Table.

Function Description

Security Mode	Description
First Lock	<p>Samurai-6M/6MX (ADM6996M/MX) locks the first SA+FID of packets received on the port. After the first (SA+FID) is locked, Samurai-6M/6MX (ADM6996M/MX) starts to check packets with different (SA+FID).</p> <ol style="list-style-type: none"> 1. If the packets are not assigned as management, drop it (modify the forwarding algorithm) and record it as a source violation. 2. If the packets are management packets, and Source Violation (see 000B_H, System Control Register 1) is configured to 1_B for different kinds of packets, then Samurai-6M/6MX (ADM6996M/MX) modifies the forwarding algorithm to drop these packets. They are also recorded as a source violation. 3. If the packets are management packets and Source Violation is configured to 0_B, then Samurai-6M/6MX (ADM6996M/MX) doesn't modify the forwarding algorithm. In this situation, we don't record this case as a source violation.
First Link Lock	<p>The first received packets will be locked as First Lock. The difference is that the receiving port will not receive and learn packets any more after the port links down even if it links up again. A source violation is recorded as the First Lock. If Samurai-6M/6MX (ADM6996M/MX) modifies the forwarding algorithm it is still as the First Lock.</p>
Assign Lock	<p>Samurai-6M/6MX (ADM6996M/MX) allows users to assign the locked SA+FID through CPU's help instead of the first SA+FID. A source violation is recorded as the First Lock. If Samurai-6M/6MX (ADM6996M/MX) modifies the forwarding algorithm it is still as the First Lock.</p>
Assign Link Lock	<p>Samurai-6M/6MX (ADM6996M/MX) allows users to assign the locked SA+FID through CPU's help instead of the first SA+FID. The others are the same as the First Link Lock.</p>
Discard Unknown	<p>The "unknown source address" means that (SA+FID) is not found in the learning table or even is found but Portmap doesn't match the incoming port. If "unknown" packets are received, Samurai-6M/6MX (ADM6996M/MX) records the source violation as the First Lock. The rule to modify the forwarding algorithm is still as the First Lock.</p>
Unknown to CPU	<p>This option is the same as "Discard Unknown" except that if Samurai-6M/6MX (ADM6996M/MX) decides to modify the forwarding algorithm, it will forward the packets to the CPU port instead of dropping them.</p>
Source Intrusion	<p>If the incoming port receives the packets with SA, marked as Source Intrusion, we handle these packets in the following rule:</p> <ol style="list-style-type: none"> 1. Enabled Source Intrusion Must (see 000B_H, SIM) to instruct Samurai-6M/6MX (ADM6996M/MX) to modify the forwarding algorithm and record the source violation always. 2. If Source Intrusion Must is not enabled, Samurai-6M/6MX (ADM6996M/MX) also modifies the forwarding algorithm and records the source violation when any non-management packets are received. 3. If Source Intrusion Must is not enabled, Samurai-6M/6MX (ADM6996M/MX) also modifies the forwarding algorithm and records the source violation when management packets are received but Source Violation is configured to 1_B. 4. If Source Intrusion Must is not enabled, Samurai-6M/6MX (ADM6996M/MX) doesn't modify the forwarding algorithm and records the source violation when management packets are received and Source Violation is configured to 0_B. <p>Samurai-6M/6MX (ADM6996M/MX) allows the users to redirect the packets to the CPU port instead of dropping it when they violate the source intrusion (see Source Intrusion Action in 000B_H, SIA).</p>

Samurai-6M/6MX (ADM6996M/MX) supports stricter security protection. The port is disabled when there is a source violation. Enable Security Option[3] to enable this feature.

3.1.20 Packet Forwarding

Samurai-6M/6MX (ADM6996M/MX) identifies packet headers and transfers it from the incoming port to the destination ports.

3.1.20.1 Control Table

Samurai-6M/6MX (ADM6996M/MX) provides a control table for user to control the forwarding algorithm of the DA = 01 80 C2 00 00 00_H ~ DA = 01 80 C2 00 00 2F_H easily. This control table is defined in 0074_H ~ 008B_H.

3.1.20.2 Default Output Ports

The default output ports that a packet is transferred to are determined in the following order.

1. The Portmap in the Special Tag with Portmap_Valid = 1 is used as the output ports.
2. The Portmap in the learning table is used as the output ports, when (DA+FID) matches an entry in the learning table.
3. The Portmap in the hardware IGMP table is used as the output ports, when DA matches an entry in the hardware IGMP table and “Hardware IGMP Snooping” (see 000C_H, **HISE**) is enabled.
4. “Broadcast Portmap” (see 001A_H, **BP**) is used as the output ports, when the incoming packet is a broadcast packet.
5. “Multicast Portmap” (see 001B_H, **MP**) is used as the output ports, when the incoming packet is a multicast packet.
6. “Unicast Portmap” (see 0019_H, **UP**) is used as the output ports, when the incoming packet is a unicast packet.

3.1.20.3 Forwarding Algorithm

Table 38 Forwarding Algorithm

Packets Identified by Samurai-6M/6MX (ADM6996M/MX)	Algorithm
BPDU/SLOW/PAE/RESER_R0/ RESER_R1/GXRP/RESER_R2/ RESER_R3	IF (Portmap_Valid in the Special Tag is 1), THEN use Portmap in the Special Tag as the output ports. ELSE IF ((DA+FID) matches an entry in the learning table)), THEN use the Portmap in the learning table as the output ports. ELSE IF (DA matches an entry in the control table), THEN the output ports are the Portmap in the table. ELSE are the output ports are the intersection of the Pass Portmap (see 003D _H New Reserve Address Control Register 0 and 003E _H New Reserve Address Control Register 1) and the “Reserve Portmap” in the EEPROM (see 001C _H , RP)
ARP/RARP	IF (Portmap_Valid in the Special Tag is 1), THEN use Portmap in the Special Tag as the output ports. ELSE IF (ARP/RARP is trapped), THEN use ARP/RARP Portmap as the output ports. ELSE uses “Default Output Ports” as the output ports.

Table 38 Forwarding Algorithm (cont'd)

Packets Identified by Samurai-6M/6MX (ADM6996M/MX)	Algorithm
IGMP_IP/MLD_IP/MLD_IPV6	IF (Portmap_Valid in the Special Tag is 1), THEN use Portmap in the Special Tag as the output ports. ELSE IF (Hardware IGMP Snooping is enabled), IF (Hardware IGMP Packet Ignore CPU Port is enabled), THEN forwards packets to Multicast Portmap but doesn't forward to the CPU port. Else forwards packets to Multicast Portmap. ELSE IF (IGMP_IP/MLD_IP/MLD_IPV6 is trapped), THEN use IGMP/IGMP_IP/MLD_IP/MLD_IPV6 Portmap as the output ports. ELSE uses "Default Output Ports" as the output ports.
TYPE	IF (Portmap_Valid in the Special Tag is 1), THEN use Portmap in the Special Tag as the output ports. ELSE uses Type Portmap as the output ports.
PROTOCOL	IF (Portmap_Valid in the Special Tag is 1), THEN use Portmap in the Special Tag as the output ports. ELSE uses Protocol Portmap as the output ports.
TCPUDP	IF (Portmap_Valid in the Special Tag is 1), THEN use Portmap in the Special Tag as the output ports. ELSE uses TCPUDP Portmap as the output ports.
MAC_CTRL	IF (Portmap_Valid in the Special Tag is 1), THEN use Portmap in the Special Tag as the output ports. ELSE uses MAC CTRL Portmap as the output ports.
Others	Use "Default Output Ports" as the output ports

3.1.21 802.1x Security Function

Samurai-6M/6MX (ADM6996M/MX) supports flexible security modes to implement 802.1x security function. If "unauthorized" packets are received, Samurai-6M/6MX (ADM6996M/MX) will forward the packets to the CPU port to secure the forwarding algorithm.

The following chart shows the identification flow for the security.

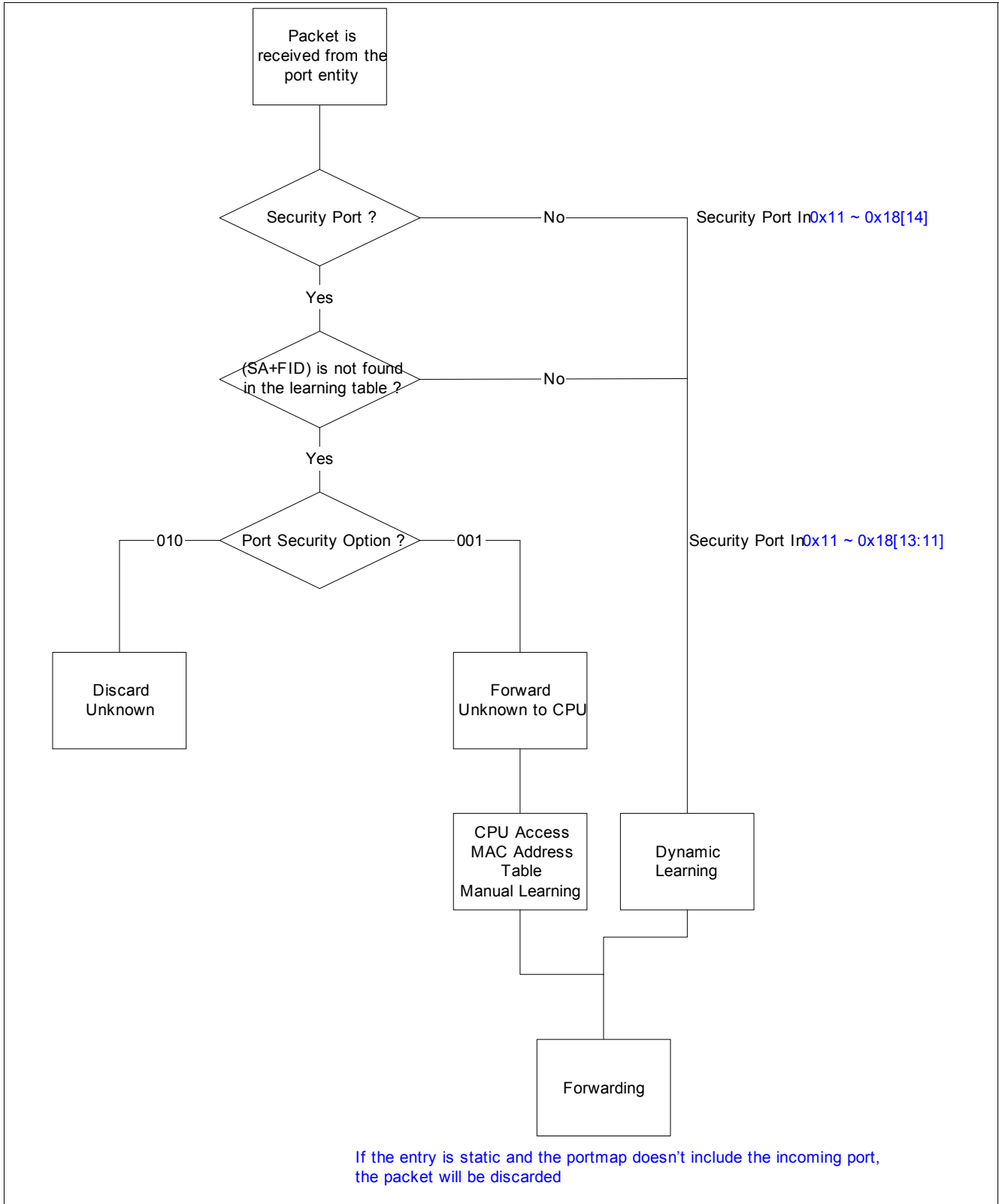

Figure 6 Flow chart of 802.1x Security Function

3.1.22 Special TAG

Special Tag is inserted after the Ethernet SA field allows the CPU to tell the switch how to handle the packets it sends or to know the source port when the CPU receives a packet.

8 Bytes	Preamble
6 Bytes	DA
6 Bytes	SA
Byte 0	Special Tag 0
Byte 1	Special Tag 1
Byte 2	Special Tag 2
Byte 3	Special Tag 3
Byte 4	Special Tag 4
Byte 5	Special Tag 5
4 Bytes	VLAN Tag
6 Bytes	SNAP
2 Bytes	Type/Length
	Data
4 Bytes	CRC

3.1.22.1 Special Tag for the Receive

Users are allowed to enable Special TAG Receive (0011_H, **STRE**) function to instruct Samurai-6M/6MX (ADM6996M/MX) to check the Special Tag to see if this field contains any commands when packets are received on the CPU port.

Table 39 Special Tag for the Receive

Special TAG	Description
Byte 0	ADM Prefix 0.
Byte 1	ADM Prefix 1. When Special TAG Receive is enabled, Samurai-6M/6MX (ADM6996M/MX) will compare {ADM Prefix -, ADM Prefix 1} with ADM TAG Ether Type (see 002E _H , ATET). If they are different, Special Tag is ignored. If they are the same, Samurai-6M/6MX (ADM6996M/MX) uses the Special Tag to make switching decisions.
Byte 2	Bit [7]: Don't care Bit [6]: Portmap_Valid 1 _B , Valid 0 _B , Not Valid Bit [5:0]: Portmap in the Special Tag

Table 39 Special Tag for the Receive (cont'd)

Special TAG	Description
Byte 3	Bit [7]: Span_Valid 1 _B , Valid 0 _B , Not Valid Bit [6]: Span 1 _B , Span packet 0 _B , Not span packet Bit [5]: Management_Valid 1 _B , Valid 0 _B , Not Valid Bit [4]: Management 1 _B , Management packet 0 _B , Not management packet Bit [3]: Cross_VLAN_Valid 1 _B , Valid 0 _B , Not Valid Bit [2]: Cross_VLAN 1 _B , Cross_Vlan packet 0 _B , Not Cross_VLAN packet Bit [1]: LRN_Valid 1 _B , Valid 0 _B , Not Valid Bit [0]: LRN 1 _B , Learn 0 _B , Not Learn
Byte 4	Bit[7]: Ignore Bit[6]: PRI_Valid 1 _B , Valid 0 _B , Not Valid Bit[5:4]: PRI 00 _B , Queue 0 01 _B , Queue 1 10 _B , Queue 2 11 _B , Queue 3 Bit [3]: Ignore Bit [2]: TXTAG_Valid 1 _B , Valid 0 _B , Not Valid Bit [1:0]: TXTAG
Byte 5	Bit [6]: Tagged Member Valid 1 _B , Valid 0 _B , Not Valid Bit [5:0]: Tagged Member, Bit[X] = 1: Port is in the tagged member

3.1.22.2 Special Tag for the Transmit

Users are allowed to enable Special TAG Transmit (0011_H, **STTE**) function to instruct Samurai-6M/6MX (ADM6996M/MX) to insert the Special Tag followed SA in the packets transmitted from the CPU port. Samurai-6M/6MX (ADM6996M/MX) also allows users to choose what kinds of packets they don't want to insert this Special Tag even when Special TAG Transmit (0011_H, **STTE**) function is enabled.

Table 40 Option for Special Tag Transmit

Packets Identified by Samurai-6M/6MX (ADM6996M/MX)	Condition	Result
BPDU/SLOW/PAE/RESER_R0/RESER_R1/GXRP/RESER_R2/RESER_R3	Special TAG Transmit = 0 _B . or{Special TAG Transmit, Insert Reserve} = 10 _B .	Don't insert Special Tag on the CPU port.
	{Special TAG Transmit, Insert Reserve} = 11 _B .	Insert Special Tag on the CPU port.
ARP/RARP	Special TAG Transmit = 0 _B . or{Special TAG Transmit, Insert ARP/RARP} = 10 _B .	Don't insert Special Tag on the CPU port.
	{Special TAG Transmit, Insert ARP/RARP} = 11 _B .	Insert Special Tag on the CPU port.
IGMP_IP/MLD_IP/MLD_IPV6	Special TAG Transmit = 0 _B . or{Special TAG Transmit, Insert Snoop} = 10 _B .	Don't insert Special Tag on the CPU port.
	{Special TAG Transmit, Insert Snoop} = 11 _B .	Insert Special Tag on the CPU port.
TYPE	Special TAG Transmit = 0 _B . or{Special TAG Transmit, Insert Type} = 10 _B .	Don't insert Special Tag on the CPU port.
	{Special TAG Transmit, Insert Type} = 11 _B .	Insert Special Tag on the CPU port.
PROTOCOL	Special TAG Transmit = 0 _B . or{Special TAG Transmit, Insert Protocol} = 10 _B .	Don't insert Special Tag on the CPU port.
	{Special TAG Transmit, Insert Protocol} = 11 _B .	Insert Special Tag on the CPU port.
TCPUDP	Special TAG Transmit = 0 _B . or{Special TAG Transmit, Insert TCP/UDP} = 10 _B .	Don't insert Special Tag on the CPU port.
	{Special TAG Transmit, Insert TCP/UDP} = 11 _B .	Insert Special Tag on the CPU port.
MAC_CTRL	Special TAG Transmit = 0 _B . or{Special TAG Transmit, Insert MAC CTRL} = 10 _B .	Don't insert Special Tag on the CPU port.
	{Special TAG Transmit, Insert MAC CTRL} = 11 _B .	Insert Special Tag on the CPU port.

Table 40 Option for Special Tag Transmit (cont'd)

Packets Identified by Samurai-6M/6MX (ADM6996M/MX)	Condition	Result
Others	Special TAG Transmit = 0 _B . or{Special TAG Transmit, Insert Default, Source Violation} = 100 _B .	Don't insert Special Tag on the CPU port.
	{Special TAG Transmit, Insert Default, Source Violation} = 110 _B . or{Special TAG Transmit, Insert Default, Source Violation} = 101 _B . {Special TAG Transmit, Insert Default, Source Violation} = 111 _B .	Insert Special Tag

Table 41 Special Tag for the Transmit

Special TAG	Description
Byte 0	ADM Prefix 0.
Byte 1	ADM Prefix 1.
Byte 2	Bit [7]: Source Violation. 1 = This packet is a source violated packet and its forwarding algorithm to the CPU port was modified. 0 = This packet is not a source violated packet. Bit [6]: Mirror. 1 = This is a mirrored packet. 0 = This is not a mirrored packet. Bit [5]: Span. 1 = This is a span packet. 0 = This is not a span packet. Bit [4]: Management. 1 = This is a management packet. 0 = This is not a management packet. Bit [3]: Ignore. Bit [2:0]: Source Port. 000 _B = Port 0. 001 _B = Port 1. 010 _B = Port 2. 011 _B = Port 3. 100 _B = Port 4. 101 _B = Port 5.
Byte 3	Egress TAG[15:8].
Byte 4	Egress TAG[7:0].
Byte 5	Ignore.

3.2 Port4 and Port5 MII Connection

In ADM6996M/MX, there are 3 different configurations (Normal PHY, MAC type MII and PCS type MII, **CFG0**) for Port4. If Port4 is configured in normal PHY mode, then it is identical to Port0~Port3 and Port4's MII signals are ignored. If Port4 is configured in MAC type MII mode, it can be used for the HomePNA application and embedded single PHY will not be used. In ADM6996M/MX, the most popular is to configure Port4 as the PCS type MII for the router's WAN port application. Users can see **Figure 7** and **Figure 10** for more clear picture. For the Port5, there are three different configurations (MAC type MII mode, GPSI mode and RMII, **P5_BUSMD0**) for connecting to CPU's MII/GPSI or RMII interface.

Here we depicted two general router applications of ADM6996M/MX, one is connected to CPU with single MII and another is connected to CPU with dual MII. In **Figure 7**, we can see either LAN to WAN or WAN to LAN, the packets will go through the same MII port. Because the CPU need to send out the packets with the registered MAC ID to the WAN port, and this MAC ID may also come in from the LAN ports. We know the switch learning scheme can't permit the packets with same MAC ID input from different ports. In the ADM6996M/MX design, we use the MAC clone and VLAN group to solve this problem. From **Figure 10**, users can have more details for this implementation.

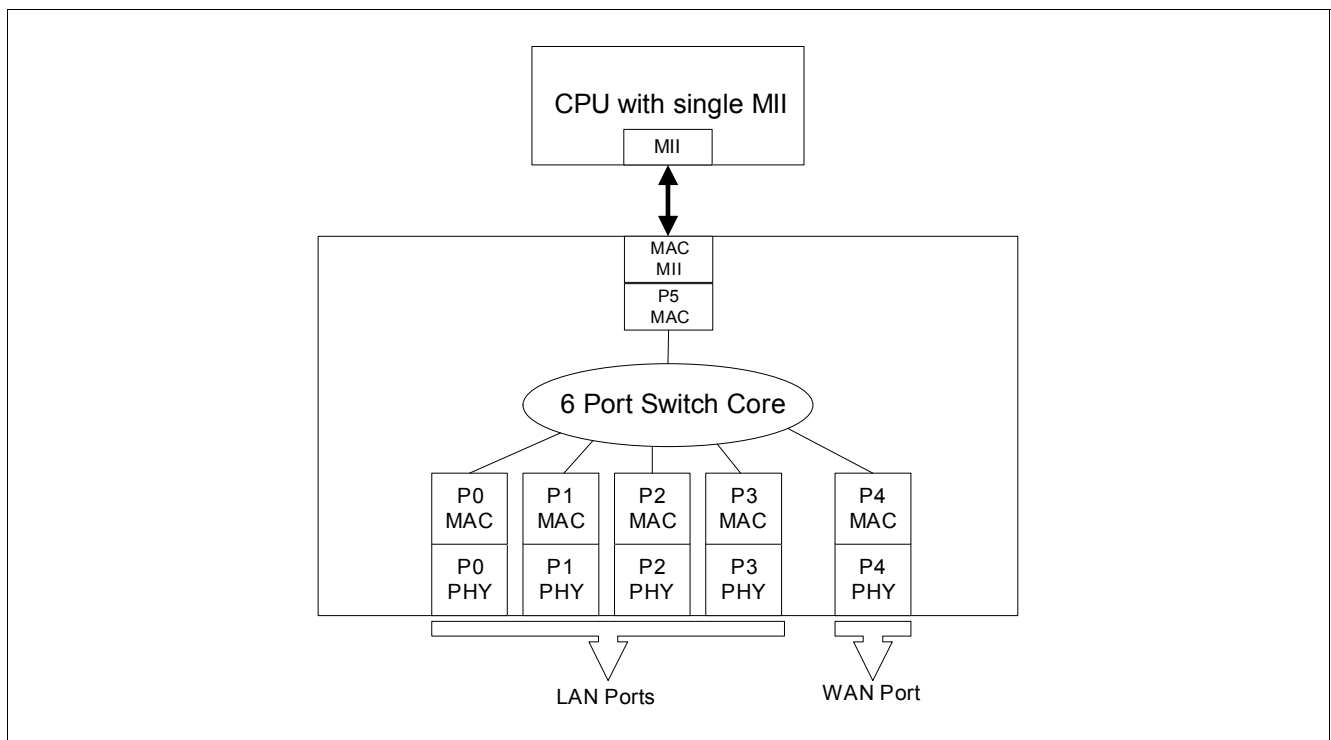

Figure 7 ADM6996M/MX to CPU with single MII Connection

Implementation of WAN/LAN applications on Samurai

ADM6996M/MX implements WAN/LAN application by ADM6996M/MX Special TAG functions.

Special Tag is inserted after the Ethernet SA field to allow the CPU to tell the switch how to handle the packets it sends or to know the source port when the CPU receives a packet.

Table 42 Special Tag

Preamble	DA	SA	Special TAG 0	Special TAG 1	Special TAG 2	Special TAG 3	Special TAG 4	Special TAG 5	VLAN Tag	SNAP	Type/Length	Data	CRC
8B	6B	6B	Byte 0	Byte 1	Byte 2	Byte 3	Byte 4	Byte 5	4B	6B	2B		4B

Step 1: Set EEPROM 11_H[12]=1 to enable Special TAG Receive (CPU to ADM6996M/MX).
 Step 2: Set EEPROM 11_H[11]=1 to enable Special TAG Transmit (ADM6996M/MX to CPU).
 Set EEPROM 11_H[15:13] to assign CPU Port Number. Default CPU Port is "101 - Port5".
 Set EEPROM 0B_H[5] to set the option whether ADM6996M/MX CPU Port checks CRC for the packet with Special TAG Receive.
 Set EEPROM 11_H[10] to set the option whether ADM6996M/MX adds Special TAG Transmit to Pause frame.
 The configurations are as follows.

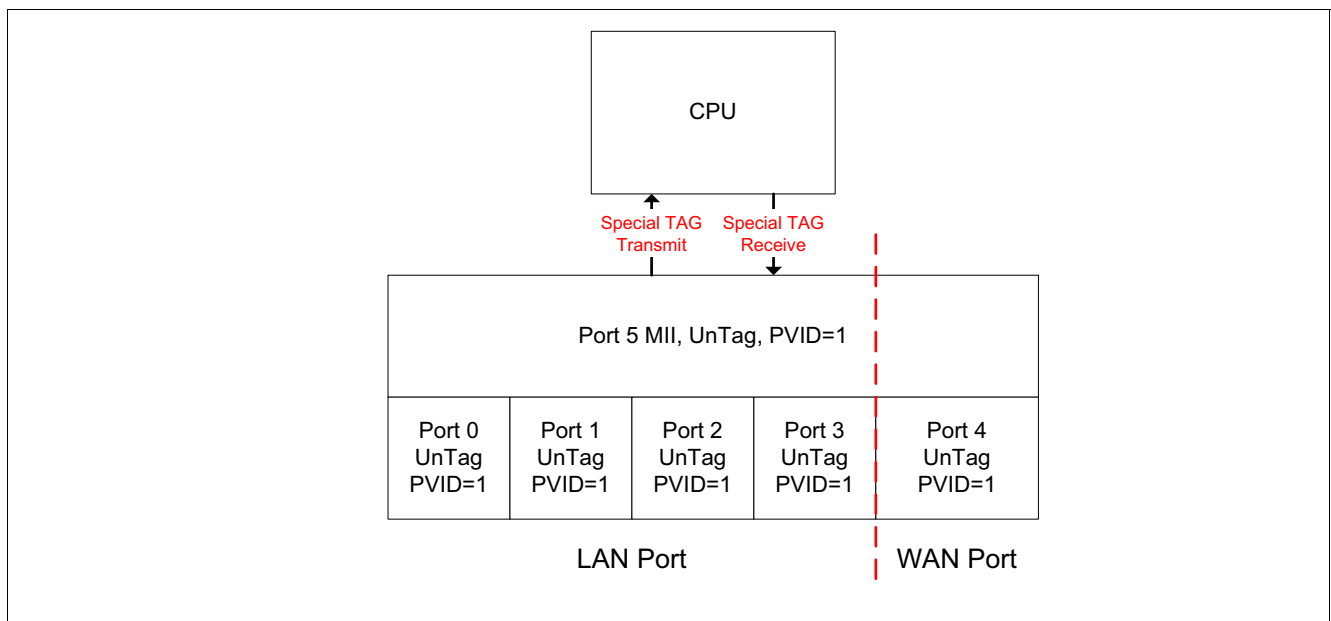

Figure 8 The configurations of the implementation by ADM6996M/MX Special TAG functions

- Step 1: Set ADM6996M/MX to port-based VLAN mode (default)
- Step 2: Set WAN/LAN group

Table 43 Set WAN/LAN Group

EEPROM	Received Port	Forwarding Group					
	Port-based Group	Port 0	Port 1	Port 2	Port 3	Port 4	Port 5
40 _H	Port 0	✓	○	○	○		✓
42 _H	Port 1	○	✓	○	○		✓
44 _H	Port 2	○	○	✓	○		✓
46 _H	Port 3	○	○	○	✓		✓
48 _H	Port 4(WAN Port)					✓	✓
4A _H	Port 5(CPU Port)	✓	✓	✓	✓	✓	✓

Note: "✓" is necessary and "○" is option to implement Port-based VLAN function of LAN group.

Port 0, Port 0/1/2/3/5, set REG 40_H to 002F_H
 Port 1, Port 0/1/2/3/5, set REG 42_H to 002F_H
 Port 2, Port 0/1/2/3/5, set REG 44_H to 002F_H
 Port 3, Port 0/1/2/3/5, set REG 46_H to 002F_H
 Port 4, Port 4/5, set REG 48_H to 0030_H
 Port 5, Port 0/1/2/3/4/5, set REG 4A_H to 003F_H

- Step 3: Set EEPROM 11_H[12:11]="11" to enable Special TAG Receive/Transmit Enable

Software Operation:

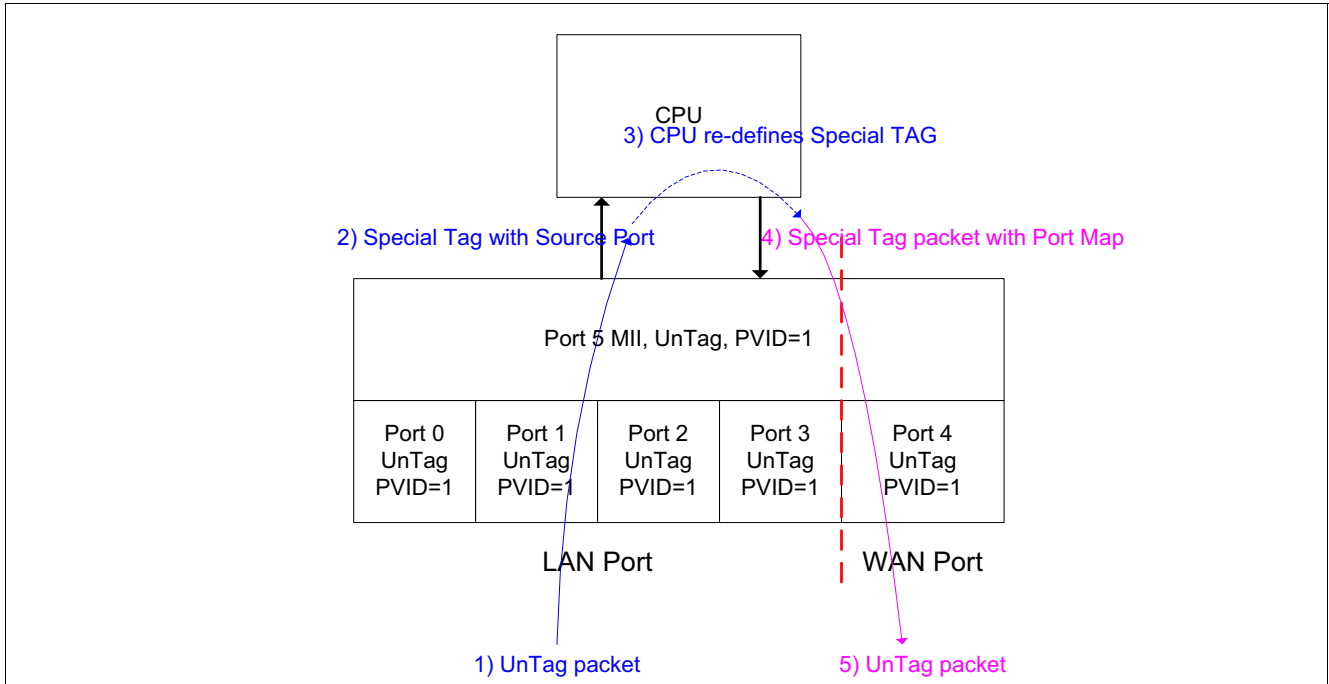

Figure 9 Software Operation

- Step 1:
 - If Untag packet received from LAN Port forwards to CPU Port, ADM6996M/MX will insert Special TAG followed SA in the packets transmitted from the CPU port. ADM6996M/MX also allows users to choose what kinds of packets they don't want to insert this Special TAG in.

Table 44 Packets Identified by ADM6996M/MX

Packets Identified by ADM6996M/MX	Condition (EEPROM 0x11h[11] and 0x99h[8:0])	Result
BPDU/SLOW/ PAE/RESER_R0/ RESER_R1/ GXP/RESER_R2/ RESER_R3	Special TAG Transmit = 0 _B . or {Special TAG Transmit, Insert Reserve} = 10 _B .	Don't insert Special Tag on the CPU port.
	{Special TAG Transmit, Insert Reserve} = 11 _B	Insert Special Tag on the CPU port.
ARP/RARP	Special TAG Transmit = 0 _B . or {Special TAG Transmit, Insert ARP/RARP} = 10 _B .	Don't insert Special Tag on the CPU port.
	{Special TAG Transmit, Insert ARP/RARP} = 11 _B .	Insert Special Tag on the CPU port.
IGMP_IP/MLD_IP/ MLD_IPV6	Special TAG Transmit = 0 _B . or {Special TAG Transmit, Insert Snoop} = 10 _B .	Don't insert Special Tag on the CPU port.
	{Special TAG Transmit, Insert Snoop} = 11 _B .	Insert Special Tag on the CPU port.

Table 44 Packets Identified by ADM6996M/MX (cont'd)

Packets Identified by ADM6996M/MX	Condition (EEPROM 0x11h[11] and 0x99h[8:0])	Result
TYPE	Special TAG Transmit = 0 _B . or {Special TAG Transmit, Insert Type} = 10 _B .	Don't insert Special Tag on the CPU port.
	{Special TAG Transmit, Insert Type} = 11 _B .	Insert Special Tag on the CPU port.
PROTOCOL	Special TAG Transmit = 0 _B . or {Special TAG Transmit, Insert Protocol} = 10 _B .	Don't insert Special Tag on the CPU port.
	{Special TAG Transmit, Insert Protocol} = 11 _B .	Insert Special Tag on the CPU port.
TCPUDP	Special TAG Transmit = 0 _B . or {Special TAG Transmit, Insert TCP/UDP} = 10 _B .	Don't insert Special Tag on the CPU port.
	{Special TAG Transmit, Insert TCP/UDP} = 11 _B .	Insert Special Tag on the CPU port.
MAC_CTRL	Special TAG Transmit = 0 _B . or {Special TAG Transmit, Insert MAC CTRL} = 10 _B .	Don't insert Special Tag on the CPU port.
	{Special TAG Transmit, Insert MAC CTRL} = 11 _B .	Insert Special Tag on the CPU port.
Others	Special TAG Transmit = 0 _B . or {Special TAG Transmit, Insert Default, Source Violation} = 100 _B .	Don't insert Special Tag on the CPU port.
	{Special TAG Transmit, Insert Default, Source Violation} = 110 _B . or	Insert Special Tag
	{Special TAG Transmit, Insert Default, Source Violation} = 101 _B .	
	{Special TAG Transmit, Insert Default, Source Violation} = 111 _B .	

- Step 2: CPU must re-define the Special TAG for the Receive to determine the destination group.
- Step 3: If **MAC_CLONE** function is enabled, CPU must set **LRN** parameter to disable learning mechanism for specific packet.

In **Figure 10**, it shows an easy way to connect the CPU with dual MII for the routing application. In this application, Port4's embedded and isolated PHY will be connected to the WAN port. CPU will act as the bridge to translate the packet's frame for LAN/WAN and use different MII to handle the packets either from LAN to WAN or from WAN to LAN. The isolated PHY is helpful to reduce the BOM cost.

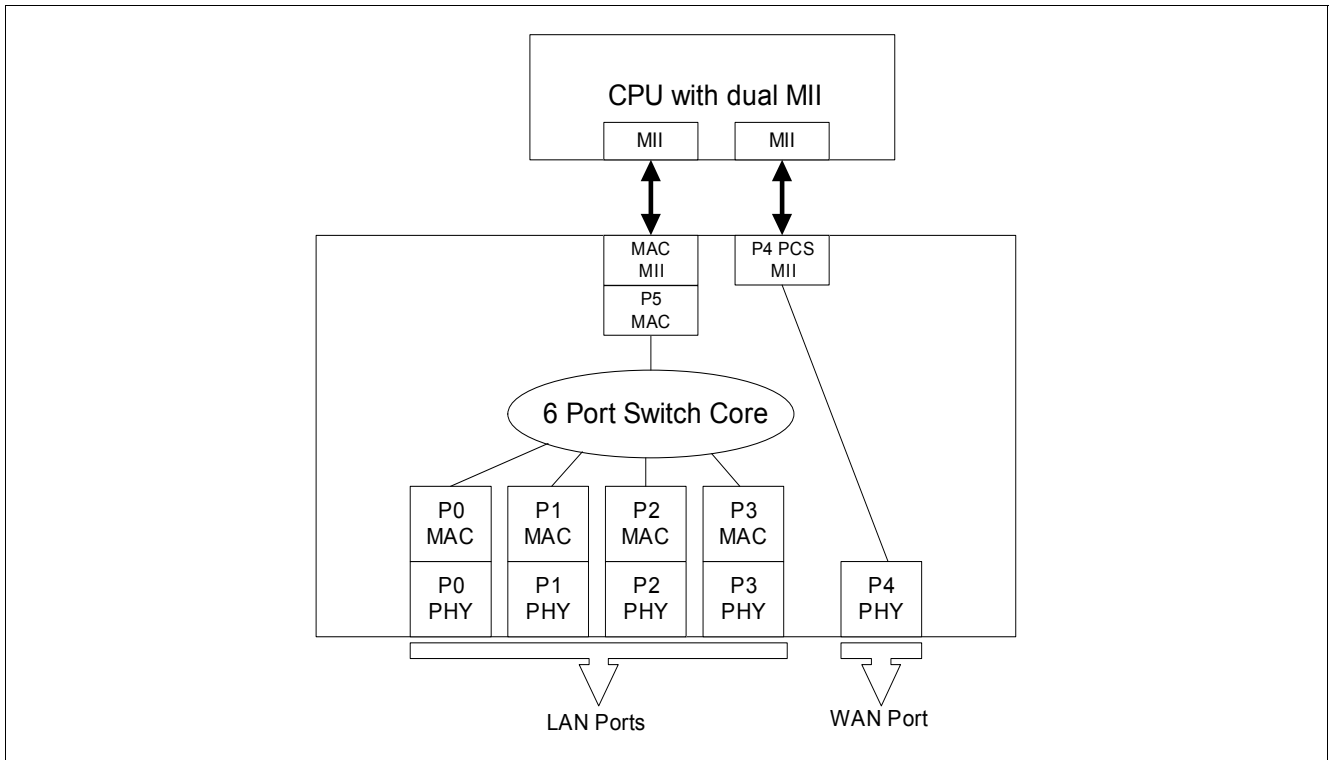

Figure 10 ADM6996M/MX to CPU with dual MII Connection

Normally, the MAC mode MII should be connected to the PHY mode MII. But in some applications, we need to connect both MAC mode MII to each other as shown. In [Figure 10](#), due to most CPU's MII being MAC mode, Port4 is PCS to MAC connection and Port5 is MAC to MAC connection.

Through the hardware setting, it is easy to set ADM6996M/MX Port5 MII to be operating in 100M Full duplex mode. And this kind mode (100M Full) is normally the operation mode to be with CPU, the interface connection is described in the following diagram.

- (1) CKO25M is the 25M clock driven out by ADM6996M/MX to fit 100M MII operation. This clock output provides 8mA driving capability and it can directly connected to TXCLK/RXCLK.
- (2) Due to Full duplex mode, so COL is tied to GND.

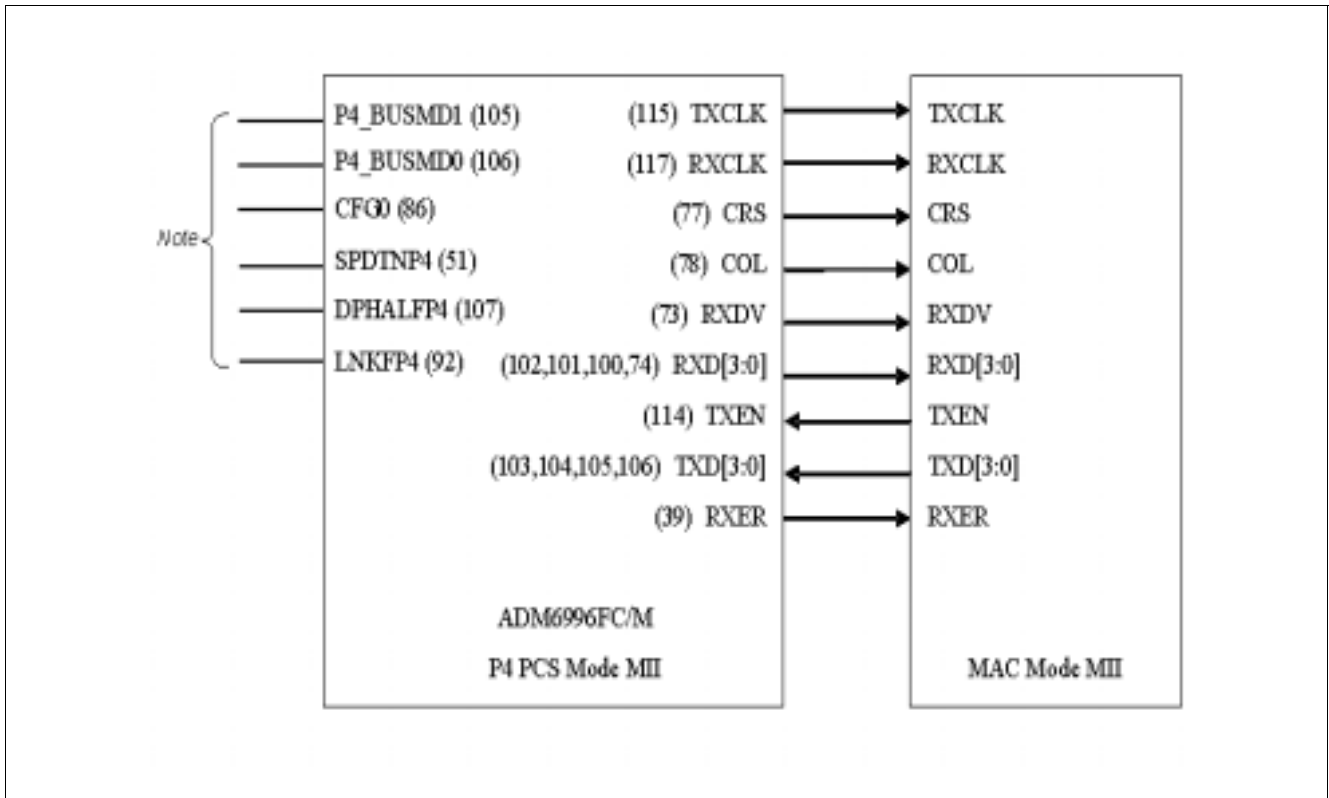

Figure 11 100M Full duplex MAC to MAC MII Connection

Note:

1. Pin 60 and pin 61 should be pull low to let P5_BUSMD be latched as “00” and make Port5 be operating in MII mode (P5_BUSMD0).
2. Pin 89 (SPDTNP5) should be pull low or floating to set Port5 be operating in 100Mbit/s.
3. Pin 91 (DPHALFP5) should be pull low or floating to set Port5 be operating in full duplex mode.
4. Pin 90 (LNKFP5) should be pull low or floating to set Port5 Link up.

About the PCS mode MII connecting to MAC mode MII, it’s very straightforward. If PCS and MAC follow the MII standard timing and users notice the PCB layout balance, it should not be an issue for PCS to connect to the MAC. In [Figure 12](#), we depicted this interface connection and described how to configure Port4 as the PCS mode MII.

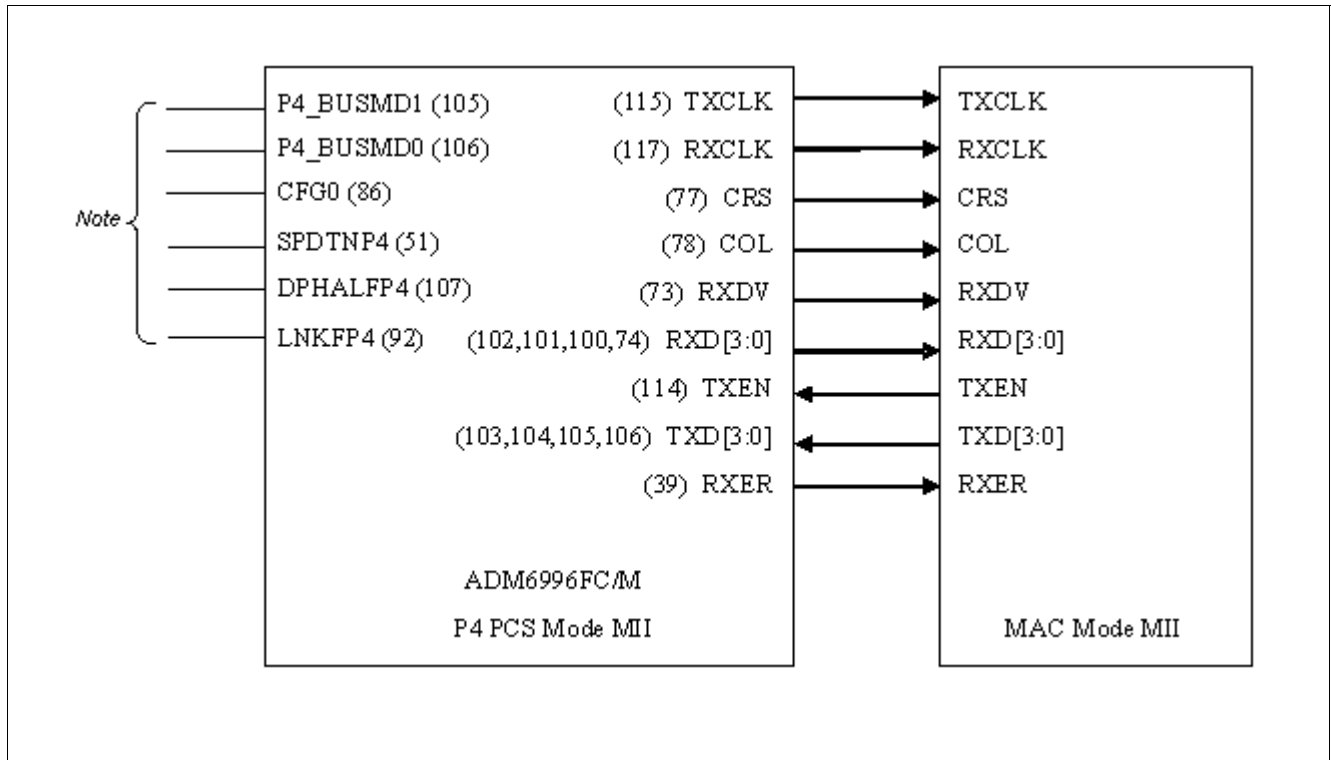

Figure 12 PCS to MAC MII connection

Note:

5. From the **CFG0** pin description, we know it needs to set {CFG0, P4_BUSMD[1:0]} as 1xx_B to configure Port4 be operating in PCS mode MII. So it doesn't matter the value on P4_BUSMD[1:0] (pin 105 and pin 106) and we only pull high the CFG0 or make it floating (due to it has internally pull high) is ok.
6. Pin 51 (SPDTNP4) acts as DUPLEX LED for Port 4; in half duplex mode, it is collision LED for each port.
7. Pin 107 (DPHALFP4) used to indicate the speed status of Port 4.
8. Pin 92 (LNKFP4) used to indicate the link/activity status of Port 4.

3.3 10/100M PHY Block

The 100Base-X section of the device implements the following functional blocks:

- 100Base-X physical coding sub-layer (PCS)
- 100Base-X physical medium attachment (PMA)
- 100Base-X physical medium dependent (PMD)

The 10Base-T section of the device implements the following functional blocks:

- 10Base-T physical layer signaling (PLS)
- 10Base-T physical medium attachment (PMA)

The 100Base-X and 10Base-T sections share the following functional blocks:

- Clock synthesizer module
- MII Registers
- IEEE 802.3u auto negotiation

The interfaces used for communication between PHY block and switch core is MII interface.

Auto MDIX function is supported. This function can be Enable/Disabled by the hardware pin.

The Digital approach for the integrated PHY of Samurai-6M/6MX (ADM6996M/MX) has been adopted.

3.3.1 Auto Negotiation

The Auto Negotiation function provides a mechanism for exchanging configuration information between two ends of a link segment and automatically selecting the highest performance mode of operation supported by both devices. Fast Link Pulse (FLP) Bursts provide the signaling used to communicate auto negotiation abilities between two devices at each end of a link segment. For further details regarding auto negotiation, refer to Clause 28 of the IEEE 802.3u specification. The Samurai-6M/6MX (ADM6996M/MX) supports four different Ethernet protocols, so the inclusion of auto negotiation ensures that the highest performance protocol will be selected based on the ability of the link partner.

The auto negotiation function within the Samurai-6M/6MX (ADM6996M/MX) can be controlled either by internal register access or by the use of configuration pins are sampled. If disabled, auto negotiation will not occur until software enables bit 12 in MII register 0. If auto negotiation is enabled, the negotiation process will commence immediately.

When auto negotiation is enabled, the Samurai-6M/6MX (ADM6996M/MX) transmits the abilities programmed into the auto negotiation advertisement register at address 04h via FLP bursts. Any combination of 10 Mbit/s, 100 Mbit/s, half duplex, and full duplex modes may be selected. Auto negotiation controls the exchange of configuration information. Upon successfully auto negotiation, the abilities reported by the link partner are stored in the auto negotiation link partner ability register at address 05_H.

The contents of the “auto negotiation link partner ability register” are used to automatically configure to the highest performance protocol between the local and far-end nodes. Software can determine which mode has been configured by auto negotiation by comparing the contents of register 04_H and 05_H and then selecting the technology whose bit is set in both registers of highest priority relative to the following list.

100Base-TX full duplex (highest priority)

100Base-TX half duplex

10Base-T full duplex

10Base-T half duplex (lowest priority)

The basic mode control register at address 0h provides control of enabling, disabling, and restarting of the auto negotiation function. When auto negotiation is disabled, the speed selection bit (bit 13) controls switching between 10 Mbit/s or 100 Mbit/s operation, while the duplex mode bit (bit 8) controls switching between full duplex operation and half duplex operation. The speed selection and duplex mode bits have no effect on the mode of operation when the auto negotiation enable bit (bit 12) is set.

The basic mode status register at address 1h indicates the set of available abilities for technology types (bit 15 to bit 11), auto negotiation ability (bit 3), and extended register capability (bit 0). These bits are hardwired to indicate the full functionality of the Samurai-6M/6MX (ADM6996M/MX). The BMSR also provides status on:

Whether auto negotiation is complete (bit 5)

Whether the Link Partner is advertising that a remote fault has occurred (bit 4)

Whether a valid link has been established (bit 2)

The auto negotiation advertisement register at address 4h indicates the auto negotiation abilities to be advertised by the Samurai-6M/6MX (ADM6996M/MX). All available abilities are transmitted by default, but writing to this register or configuring external pins can suppress any ability.

The auto negotiation link partner ability register at address 05h indicates the abilities of the Link Partner as indicated by auto negotiation communication. The contents of this register are considered valid when the auto negotiation complete bit (bit 5, register address 1h) is set.

3.3.2 Speed/Duplex Configuration

The twelve sets of four pins listed in [Table 45](#) configure the speed/duplex capability of each channel of Samurai-6M/6MX (ADM6996M/MX). The logic states of these pins are latched into the advertisement register (register

address 4_H) for auto negotiation purpose. These pins are also used for evaluating the default value in the base mode control register (register 0_H) according to [Table 45](#).

In order to make these pins have the same Read/Write priority as software, they should be programmed to 11111111b in case user likes to update the advertisement register through software.

Table 45 Speed/Duplex Configuration

Auto Negotiation (Pin & EEPROM)	Speed (Pin & EEPROM)	Duplex (Pin & EEPROM)	Auto Negotiation	Advertise Capability				Parallel Detect Capability			
				100F	100H	10F	10H	100F	100H	10F	10H
1	1	1	1	1	1	1	1	0	1	0	1
1	1	0	1	0	1	0	1	0	1	0	1
1	0	1	1	0	0	1	1	0	0	0	1
1	0	0	1	0	0	0	1	0	0	0	1
0	1	1	0	1	—	—	—	—	—	—	—
0	1	0	0	—	1	—	—	—	—	—	—
0	0	1	0	—	—	1	—	—	—	—	—
0	0	0	0	—	—	—	1	—	—	—	—

3.4 Hardware, EEPROM and SMI Interface for Configuration

Three ways are supported to configure the setting in the Samurai-6M/6MX (ADM6996M/MX): (1) Hardware Setting (2) EEPROM Interface (3) SMI Interface. Users can use the EEPROM and SMI interfaces combined with the CPU port to provide proprietary functions. Four pins are needed when using these two interfaces. See [Figure 13](#) for the description.

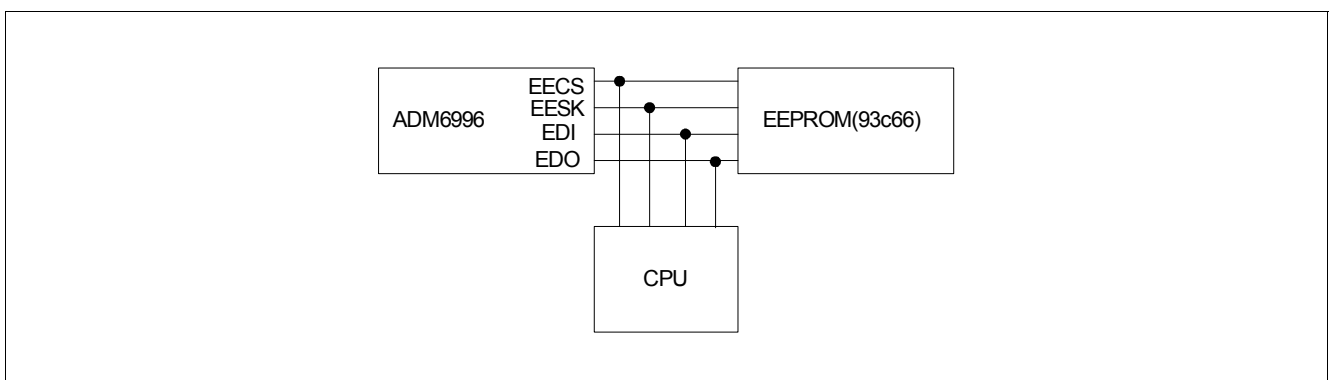

Figure 13 Interconnection between Samurai-6M/6MX (ADM6996M/MX), EEPROM and CPU

3.4.1 Hardware Setting

The Samurai-6M/6MX (ADM6996M/MX) provides some hardware pins, where values residing on will be strapped for the default setting during the power on or reset.

Table 46 Hardware Setting

Setting Name	Description
GFCEN	Global Flow Control Enable. 0 _B , Flow Control Capability is depended upon the register setting in corresponding EEPROM register 1 _B , All ports flow control capability is enabled.
SDIO_MD	SDC/SDIO mode selection. 0 _B , 16 bits mode
P5_BUSMD[1:0]	Port 5 bus mode selection bit 0. P5_BUSMD[1:0] ,Interface 00 _B , MII 01 _B , GPSI 10 _B , RMII 11 _B , Reserved and Not Allowed.
{CFG0, P4_BUSMD[1:0]}	Bus Mode of Port 4 0_00 _B , PHY Interface 0_01 _B , MAC MII 1_XX _B , PCS MII
BPEN	Recommend Back-Pressure in half-duplex. 0 _B , Disable Back-Pressure. 1 _B , Enable Back-Pressure
RECANEN	Recommend Auto Negotiation Enable. Only valid for Twisted pair interface. Programmed this bit to 1 has no effect to Fiber port. 0 _B , Disable all TP port auto negotiation capability 1 _B , Enable all TP port auto negotiation capability
XOVEN	Cross Over Enable. Only available in TP interface. 0 _B , Disable 1 _B , Enable
LED_MODE	Enable Mac to choose LED Display Mode. 0 _B , Single color LED 1 _B , Dual color LED

3.4.2 EEPROM Interface

The EEPROM Interface is provided to easily configure the setting without the CPU's help. Because the EEPROM Interface is the same as the 93c66, it also allows the CPU to write the EEPROM register and renew the 93c66 at the same time. After the power up or reset (default value from the hardware pins fetched in this stage), the Samurai-6M/6MX (ADM6996M/MX) will automatically detect the presence of the EEPROM by reading the address 0 in the 96c66. If the value = 4154_H, it will load all the data in the 93c66. If not, the Samurai-6M/6MX (ADM6996M/MX) will stop loading the 93c66. The user also can pull down the **EDO** to force the Samurai-6M/6MX (ADM6996M/MX) not to load the 93c66. The 93c66 loading time is around 30ms. Then CPU should drive the high-z value in the **EECS**, **EESK** and **EDI** pins in this period if existing the CPU to read or write the registers in the Samurai-6M/6MX (ADM6996M/MX).

The EEPROM Interface needs only one Write command to complete a "Write" operation to the Samurai-6M/6MX (ADM6996M/MX). If users would like to update the 93c66 at the same time, then three commands, Write Enable, Write, and Write Disable, are needed to complete this operation (See 93c66 Spec. for the reference). Users should note that the EEPROM interface only allows the CPU to write the EEPROM register in the Samurai-6M/6MX

(ADM6996M/MX) and doesn't support the READ command. If the CPU sends out the Read Command, then 93c66 will respond with the value inside, instead of Samurai-6M/6MX (ADM6996M/MX). Users should also note that one additional EESK cycle is needed between any continuous commands (Read or Write).

(1) Read 93c66 via the EEPROM Interface (Index = 2, Data = 1111_H).

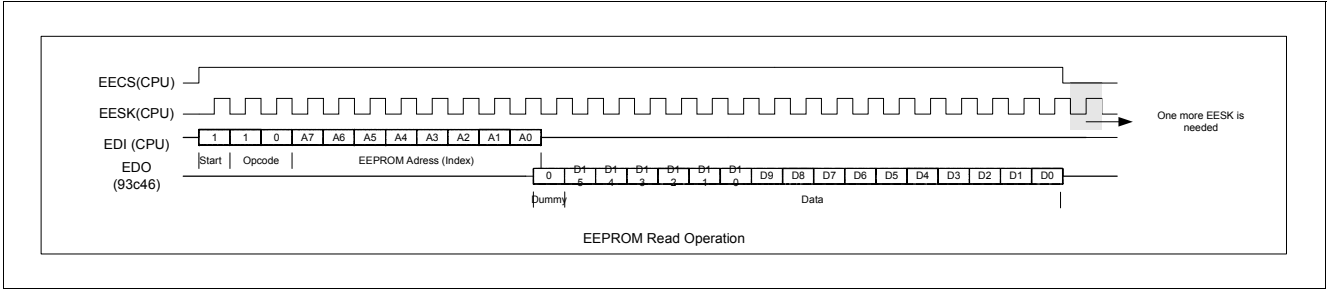

(2) Write EEPROM registers in the Samurai-6M/6MX (ADM6996M/MX) (Index = 2, Data = 16'h2222).

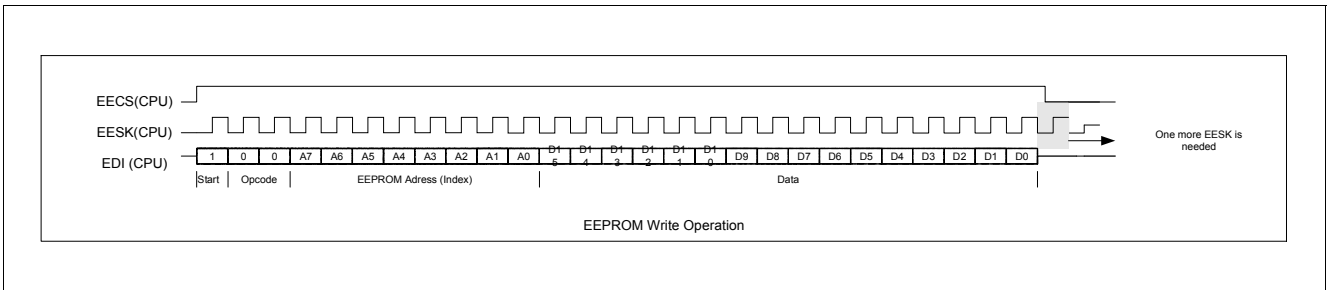

Power-On-Sequence of Samurai

The following diagram shows the power-on-sequence of Samurai.

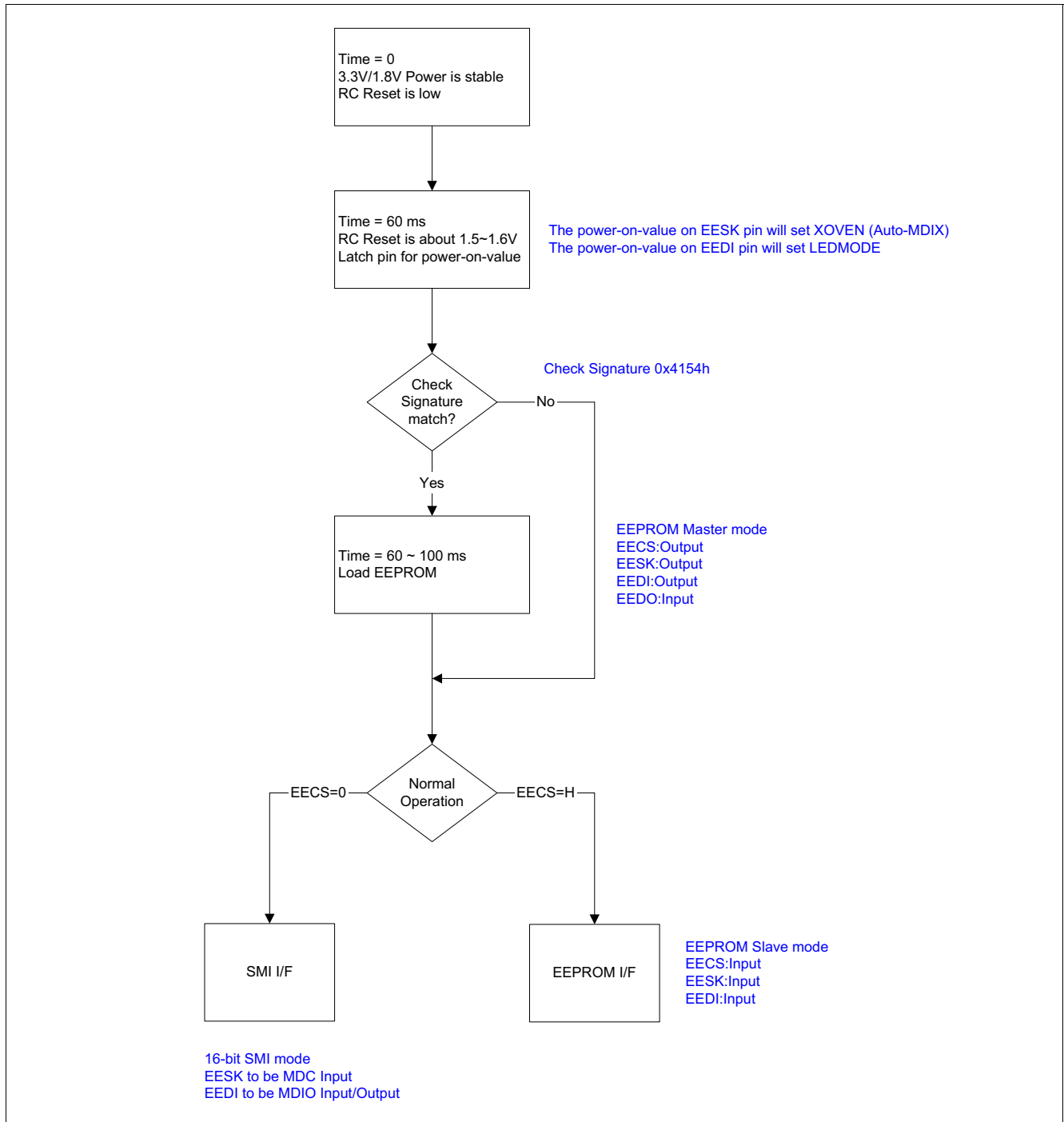

Figure 14 The Power-On-Sequence of Samurai

Set ADM6996LC/FC Pin59 SDIO_MD=1 to 16-bit SMI mode.

Set ADM6996I/M Pin59 SDIO_MD=0(default) to 16-bit SMI mode.

Timing Diagram of RC, EECS and EESK (with correct signature EEPROM)

Waveform 1: RC Reset

Waveform 2: EECS

Waveform 4: EESK

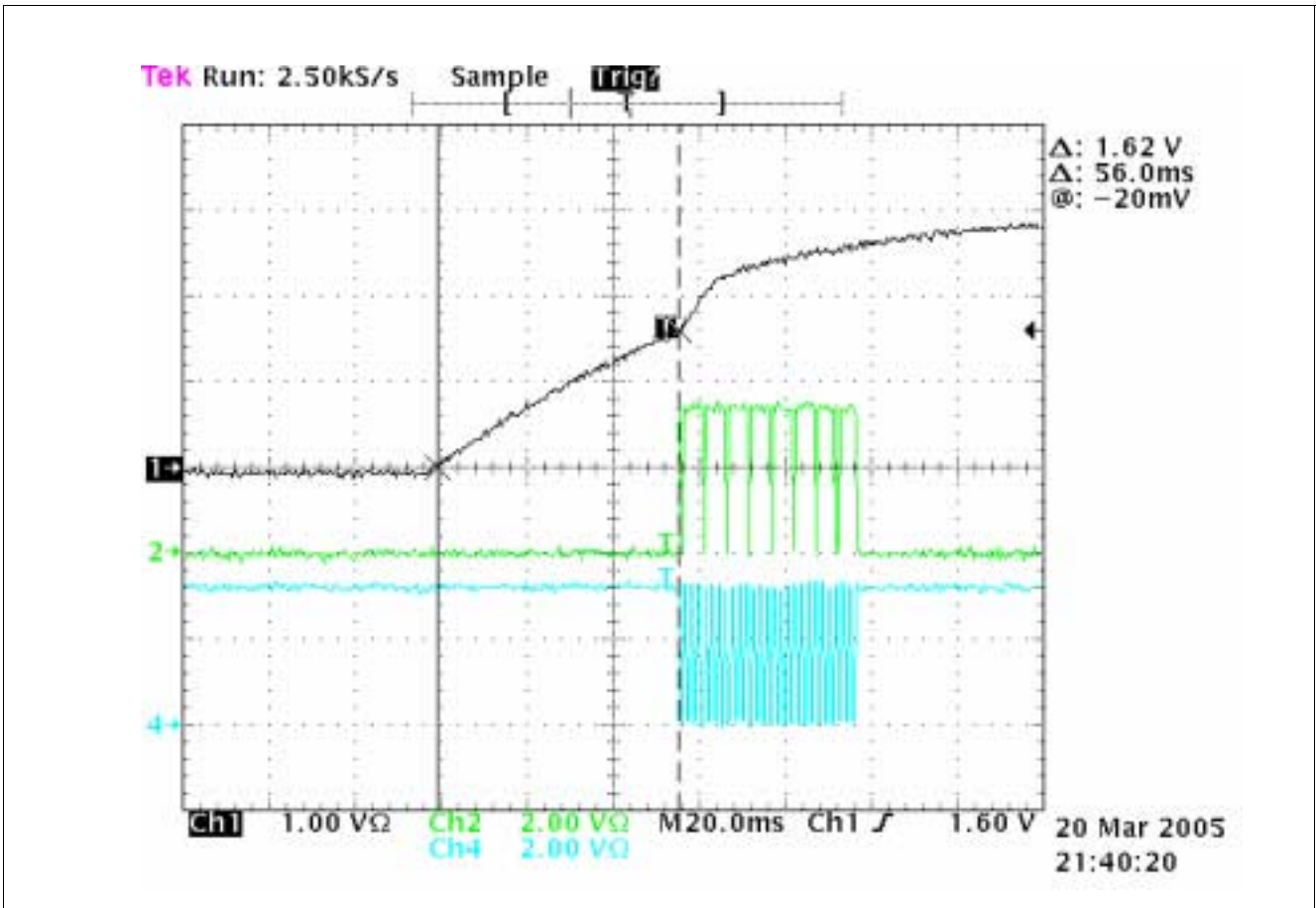

Figure 15 Timing Diagram of RC, EECS and EESK (with correct signature EEPROM)

Timing Diagram of RC, EECS and EESK (without EEPROM)

Waveform 1: RC Reset

Waveform 2: EECS

Waveform 4: EESK

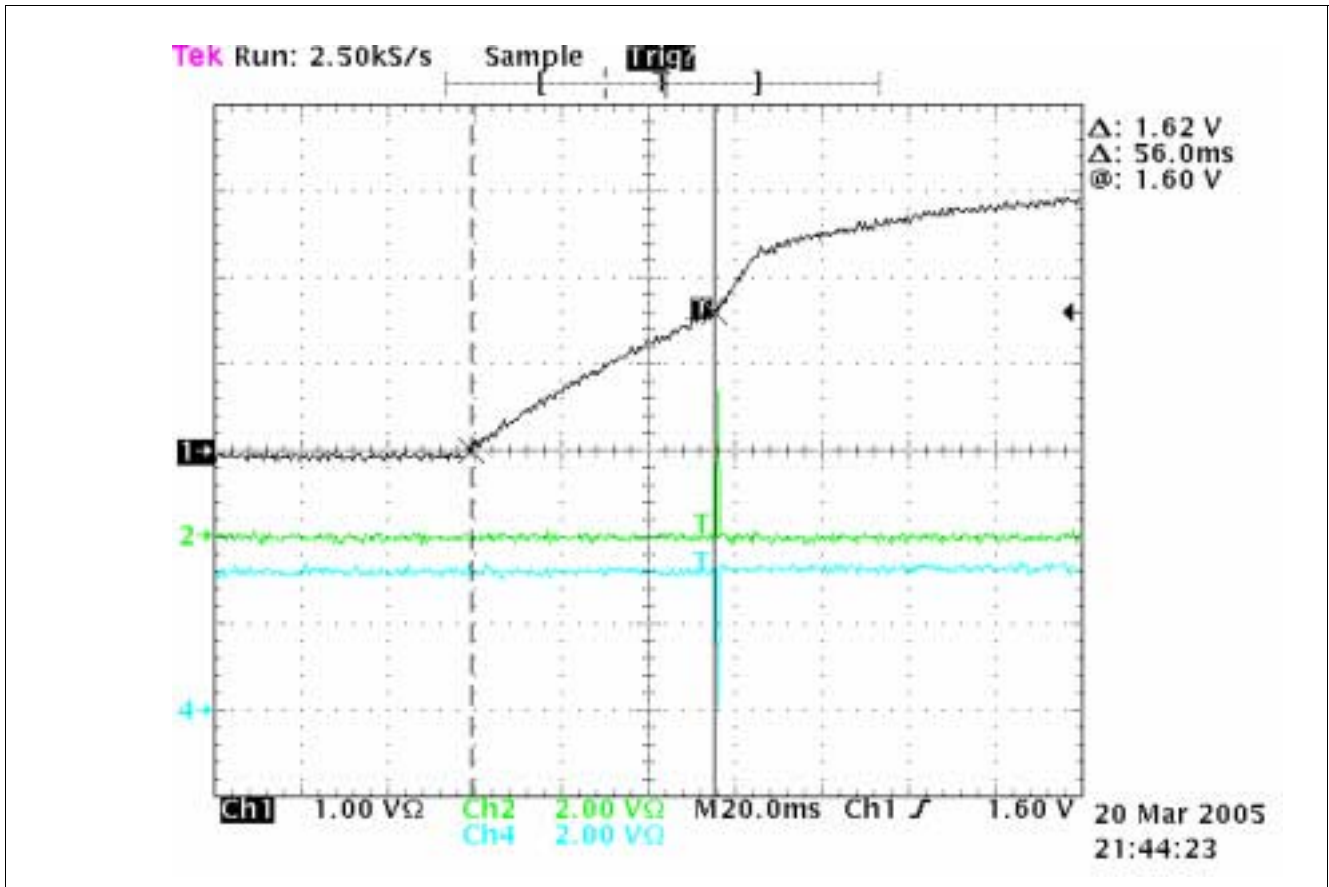

Figure 16 Timing Diagram of RC, EECS and EESK (without EEPROM)

3.4.3 SMI Interface

The SMI consists of two pins, management data clock (**EESK**) and management data input/output (**EDI**). The Samurai-6M/6MX (ADM6996M/MX) is designed to support an EESK frequency up to 25 MHz. The EDI pin is bi-directional and may be shared with other devices. EECS pin is needed to pull low if EEPROM interface is also used.

The EDI pin requires a 1.5 K Ω pull-up which, during idle and turnaround periods, will pull EDI to a logic one state. Samurai-6M/6MX (ADM6996M/MX) requires a single initialization sequence of 32 bits of preamble following power-up/hardware reset. The first 32 bits are preamble consisting of 32 contiguous logic one bits on EDI and 32 corresponding cycles on EESK. Following preamble is the start-of-frame field indicated by a $\langle 01_B \rangle$ pattern. The next field signals the operation code (OP): $\langle 10_B \rangle$ indicates read from management register operation, and $\langle 01_B \rangle$ indicates write to management register operation. The next field is the management register address. It is 10 bits wide and the most significant bit is transferred first.

During Read operation, a 2-bit turn around (TA) time spacing between the register address field and data field is provided for the EDI to avoid contention. Following the turnaround time, a 16-bit data stream is read from or written into the management registers of the Samurai-6M/6MX (ADM6996M/MX).

(A) Preamble Suppression

The SMI of Samurai-6M/6MX (ADM6996M/MX) supports a preamble suppression mode. The Samurai-6M/6MX (ADM6996M/MX) requires a single initialization sequence of 32 bits of preamble following power-up/hardware reset. This requirement is generally met by pulling-up the resistor of EDI. While the Samurai-6M/6MX (ADM6996M/MX) will respond to management accesses without preamble, a minimum of one idle bit between management transactions is required.

When Samurai-6M/6MX (ADM6996M/MX) detects that there is address match, then it will enable Read/Write capability for external access. When address is mismatched, then Samurai-6M/6MX (ADM6996M/MX) will tristate the EDI pin.

(B) Read Switch Register via SMI Interface (Offset Hex = 10'h2, Data = 16'h2600)

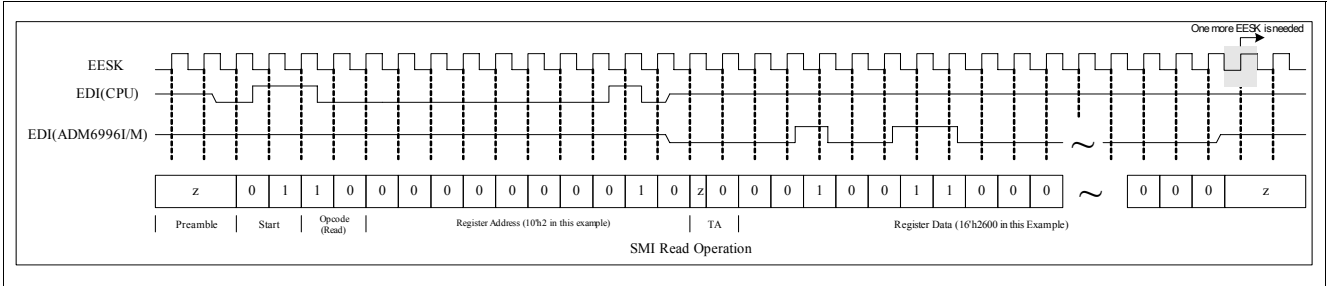

(C) Write Switch Register via SMI Interface (Offset Hex = 10'h180, Data = 16'h1300)

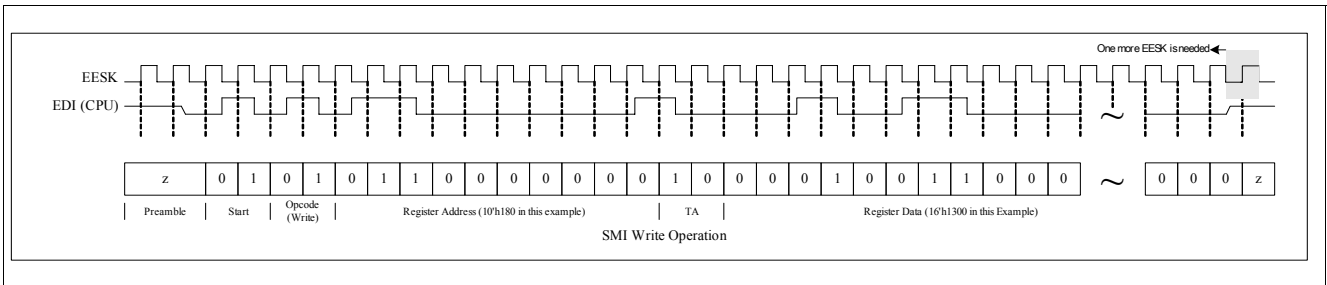

Table 47 (D) The Pin Type of EECS, EESK, EDI and EDO during the Operation

Pin Name	Reset Operation	Load EEPROM	Write Operation	Read Operation
EECS	Input	Output	Input	Input
EESK	Input	Output	Input	Input
EDI	Input	Output	Input	Input/Output
EDO	Input	Input	Input	Input

How to Use Samurai 16-bit Mode SMI to Access EEPROM/Counter/PHY Register by CPU MDC/MDIO Interface

Samurai supports 16-bit mode SMI interface to access EEPROM/Counter/PHY Register by CPU MDC/MDIO interface. The SMI interface consists of two pins, management data clock (EESK) and management data input/output (EEDI).

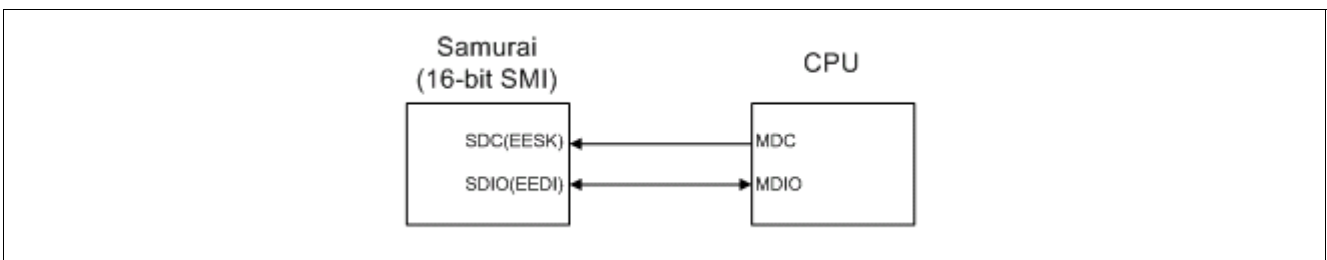

Figure 17 SMI Interface

- The difference between SMI Command and MDC/MDIO Command

- Samurai SMI Command uses 10-bit register address to access allocate EEPROM/Counter/PHY Register.

Memory Map

Table 48 Memory Map

Register	Definition
0000 _H ~ 003F _H	EEPROM BAISC Register Map
0040 _H ~ 009B _H	EEPROM Extended Register Map
00A0 _H ~ 0143 _H	Counter and Switch Status Map
0200 _H ~ 02FF _H	PHY Register Map

So you need to divide 10-bit register address to 5-bit PHY address and 5-bit REG address of MDC/MDIO command to access EEPROM/Counter Register Map. For Samurai PHY Register Map, you can set the 5-bit PHY address = '10000' and use the standard REG address to access P0~P4 PHY MII Register.

3.5 The Hardware Difference between ADM6996M/MX and ADM6996F

ADM6996FC is a power-down version to replace ADM6996F and ADM6996M/MX is advanced function version for new applications.

Pin Description(QFP128)

Table 49 Pin Description(QFP128)

Pin No.	ADM6996M/MX	ADM6996F	Notes
59	P5TXD3(SDIO_MD)	P5TXD3(VOL23)	For ADM6996FC, SDIO_MD=0 default 32bit mode For ADM6996M/MX, SDIO_MD=0 default 16bit mode Add pull-up/down resistor for ADM6996F/FC/M compatible design to avoid wrong power-on-latch.
60	P5TXD2(RMIISEL)	P5TXD2(ROMCODE25)	Add pull down resistor for ADM6996F/FC/M P5 MII mode to avoid wrong power-on-latch.
61	P5TXD1(7WIRE)	P5TXD1(P5GPSI)	Add pull down resistor for ADM6996F/FC/M P5 MII mode to avoid wrong power-on-latch.
65	INT_N	VCCIK(1.8V Digital)	Interrupt for Learning Table Access/Port Security/Counter Overflow/Port Status Add a option design to CPU INT_N pin

4 Registers Description

The EEPROM provides Samurai-6M/6MX (ADM6996M/MX) with many option settings

Main Settings

- Port Configuration: Speed, Duplex, Flow Control Capability and Tag/ Untag.
- VLAN & TOS Priority Mapping
- Broadcast Storming rate and Trunk.
- Fiber Select, Auto MDIX select
- VLAN Mapping
- Per Port Buffer number

Table 50 Registers Address Space

Module	Base Address	End Address	Note
EEPROM Basic Register Map	0000 _H	003F _H	
EEPROM Extended Register Map	0040 _H	009C _H	
Counter and Switch Status Map	00A0 _H	0143 _H	
PHY Register Map	0200 _H	02FF _H	

Table 51 Registers Overview

Register Short Name	Register Long Name	Offset Address	Page Number
SIG	Signature Register	00 _H	91
P0BC	P0 Basic Control Register	01 _H	91
P0EC	P0 Extended Control Register	02 _H	93
P1EC	P1 Extended Control Register	02 _H	
P1BC	P1 Basic Control Register	03 _H	
P2EC	P2 Extended Control Register	04 _H	
P3EC	P3 Extended Control Register	04 _H	
P2BC	P2 Basic Control Register	05 _H	
P4EC	P4 Extended Control Register	06 _H	
P5EC	P5 Extended Control Register	06 _H	
P3BC	P3 Basic Control Register	07 _H	
P4BC	P4 Basic Control Register	08 _H	
P5BC	P5 Basic Control Register	09 _H	
SC0	System Control Register 0	0A _H	94
SC1	System Control Register 1	0B _H	95
MS	Multicast Snooping Register	0C _H	97
AR	ARP/RARP Register	0D _H	99
VPM	VLAN Priority Map Register	0E _H	100
TPM	TOS Priority Map Register	0F _H	101
SC2	System Control Register 2	10 _H	102
SC3	System Control Register 3	11 _H	103

Table 51 Registers Overview (cont'd)

Register Short Name	Register Long Name	Offset Address	Page Number
SC4	System Control Register 4	12 _H	104
P0SO	Port 0 Security Option	13 _H	106
P1SO	Port 1 Security Option	14 _H	
P2SO	Port 2 Security Option	15 _H	
P3SO	Port 3 Security Option	16 _H	
P4SO	Port 4 Security Option	17 _H	
P5SO	Port 5 Security Option	18 _H	
UFGPM	Unicast Port Map and Forward Group Port Map	19 _H	107
BFGPM	Broadcast Port Map and Forward Group Port Map	1A _H	108
MFGPM	Multicast Port Map and Forward Group Port Map	1B _H	109
RFGPM	Reserve Port Map and Forward Group Port Map	1C _H	110
PIOFGPM	Packet Identification Option, Forward Group Port Map	1D _H	111
VPEFGPM	VLAN Priority Enable and Forward Group Port Map	1E _H	112
SPEFGPM	Service Priority Enable and Forward Group Port Map	1F _H	113
IFNTFGPM	Input Force No Tag and Forward Group Port Map	20 _H	114
IFFGPM	Ingress Filter and Forward Group Port Map	21 _H	115
VSDFGPM	VLAN Security Disable and Forward Group Port Map	22 _H	116
BT0	Buffer Threshold Register 0	23 _H	118
BT1	Buffer Threshold Register 1	24 _H	118
IMEIJT	IGMP/MLDTRAP Enable and Input Jam Threshold Register	25 _H	118
Q2WVECPO	Queue 2 Weight, VID Exist Check, and PPPOE Port Only	26 _H	119
Q3WBPVAO	Queue 3 Weight, Back to Port VLAN, and Admit Only VLAN-Tagged	27 _H	119
IDTEP	Input Double Tag Enable, and P0VID[11:4]	28 _H	120
ODTEP	Output Double Tag Enable, and P1VID[11:4]	29 _H	120
OTBP	Output Tag Bypass, and P2VID[11:4]	2A _H	121
P11_4	P3VID[11:4], and P4VID[11:4]	2B _H	121
RACP	Reserved Address Control, and P5VID[11:4]	2C _H	122
PHYC	PHY Control Register	2D _H	122
ATET	ADM TAG Ether Type	2E _H	123
PR	PHY Restart Register	2F _H	123
MISC	Miscellaneous Register	30 _H	124
BBC0	Basic Bandwidth Control Register 0	31 _H	125
BBC1	Basic Bandwidth Control Register 1	32 _H	125
BCE	Bandwidth Control Enable Register	33 _H	126
EBC0	Extended Bandwidth Control Register 0	34 _H	128

Table 51 Registers Overview (cont'd)

Register Short Name	Register Long Name	Offset Address	Page Number
EBC1	Extended Bandwidth Control Register 1	35 _H	129
EBC2	Extended Bandwidth Control Register 2	36 _H	129
EBC3	Extended Bandwidth Control Register 3	37 _H	130
EBC4	Extended Bandwidth Control Register 4	38 _H	130
EBC5	Extended Bandwidth Control Register 5	39 _H	131
DVMEBC6	Default VLAN Member and Extended Bandwidth Control Register 6	3A _H	131
NS0	New Storm Register 0	3B _H	132
NS1	New Storm Register 1	3C _H	133
NRAC0	New Reserve Address Control Register 0	3D _H	133
NRAC1	New Reserve Address Control Register 1	3E _H	135
HIC	Hardware IGMP Control Register	3F _H	136
VF0L	VLAN Filter 0 Low	40 _H	137
VF0H	VLAN Filter 0 High	41 _H	138
VF1L	VLAN Filter 1 Low	42 _H	
VF1H	VLAN Filter 1 High	43 _H	
VF2L	VLAN Filter 2 Low	44 _H	
VF2H	VLAN Filter 2 High	45 _H	
VF3L	VLAN Filter 3 Low	46 _H	
VF3H	VLAN Filter 3 High	47 _H	
VF4L	VLAN Filter 4 Low	48 _H	
VF4H	VLAN Filter 4 High	49 _H	
VF5L	VLAN Filter 5 Low	4A _H	
VF5H	VLAN Filter 5 High	4B _H	
VF6L	VLAN Filter 6 Low	4C _H	
VF6H	VLAN Filter 6 High	4D _H	
VF7L	VLAN Filter 7 Low	4E _H	
VF7H	VLAN Filter 7 High	4F _H	
VF8L	VLAN Filter 8 Low	50 _H	
VF8H	VLAN Filter 8 High	51 _H	
VF9L	VLAN Filter 9 Low	52 _H	
VF9H	VLAN Filter 9 High	53 _H	
VF10L	VLAN Filter 10 Low	54 _H	
VF10H	VLAN Filter 10 High	55 _H	
VF11L	VLAN Filter 11 Low	56 _H	
VF11H	VLAN Filter 11 High	57 _H	
VF12L	VLAN Filter 12 Low	58 _H	
VF12H	VLAN Filter 12 High	59 _H	
VF13L	VLAN Filter 13 Low	5A _H	
VF13H	VLAN Filter 13 High	5B _H	
VF14L	VLAN Filter 14 Low	5C _H	

Table 51 Registers Overview (cont'd)

Register Short Name	Register Long Name	Offset Address	Page Number
VF14H	VLAN Filter 14 High	5D _H	
VF15L	VLAN Filter 15 Low	5E _H	
VF15H	VLAN Filter 15 High	5F _H	
TF0	Type Filter 0	60 _H	139
TF1	Type Filter 1	61 _H	
TF2	Type Filter 2	62 _H	
TF3	Type Filter 3	63 _H	
TF4	Type Filter 4	64 _H	
TF5	Type Filter 5	65 _H	
TF6	Type Filter 6	66 _H	
TF7	Type Filter 7	67 _H	
PF_1_0	Protocol Filter 1 and 0	68 _H	140
PF_3_2	Protocol Filter 3 and 2	69 _H	
PF_5_4	Protocol Filter 5 and 4	6A _H	
PF_7_6	Protocol Filter 7 and 6	6B _H	
SPM0	Service Priority Mapping 0	6C _H	140
SPM1	Service Priority Mapping 1	6D _H	141
SPM2	Service Priority Mapping 2	6E _H	142
SPM3	Service Priority Mapping 3	6F _H	143
SPM4	Service Priority Mapping 4	70 _H	144
SPM5	Service Priority Mapping 5	71 _H	145
SPM6	Service Priority Mapping 6	72 _H	145
SPM7	Service Priority Mapping 7	73 _H	146
RA_01_00	Reserve Action for 0180C2000001~0180C2000000	74 _H	147
RA_03_02	Reserve Action for 0180C2000003~0180C2000002	75 _H	
RA_05_04	Reserve Action for 0180C2000005~0180C2000004	76 _H	
RA_07_06	Reserve Action for 0180C2000007~0180C2000006	77 _H	
RA_09_08	Reserve Action for 0180C2000009~0180C2000008	78 _H	
RA_0B_0A	Reserve Action for 0180C200000B~0180C200000A	79 _H	
RA_0D_0C	Reserve Action for 0180C200000D~0180C200000C	7A _H	
RA_0F_0E	Reserve Action for 0180C200000F~0180C200000E	7B _H	
RA_11_10	Reserve Action for 0180C2000011~0180C2000010	7C _H	

Table 51 Registers Overview (cont'd)

Register Short Name	Register Long Name	Offset Address	Page Number
RA_13_12	Reserve Action for 0180C2000013~0180C2000012	7D _H	
RA_15_14	Reserve Action for 0180C2000015~0180C2000014	7E _H	
RA_17_16	Reserve Action for 0180C2000017~0180C2000016	7F _H	
RA_19_18	Reserve Action for 0180C2000019~0180C2000018	80 _H	
RA_1B_1A	Reserve Action for 0180C200001B~0180C200001A	81 _H	
RA_1D_1C	Reserve Action for 0180C200001D~0180C200001C	82 _H	
RA_1F_1E	Reserve Action for 0180C200001F~0180C200001E	83 _H	
RA_21_20	Reserve Action for 0180C2000021~0180C2000020	84 _H	
RA_23_22	Reserve Action for 0180C2000023~0180C2000022	85 _H	
RA_25_24	Reserve Action for 0180C2000025~0180C2000024	86 _H	
RA_27_26	Reserve Action for 0180C2000027~0180C2000026	87 _H	
RA_29_28	Reserve Action for 0180C2000029~0180C2000028	88 _H	
RA_2B_2A	Reserve Action for 0180C200002B~0180C200002A	89 _H	
RA_2D_2C	Reserve Action for 0180C200002D~0180C200002C	8A _H	
RA_2F_2E	Reserve Action for 0180C200002F~0180C200002E	8B _H	
TUF0	TCP/UDP Filter 0	8C _H	150
TUF1	TCP/UDP Filter 1	8D _H	
TUF2	TCP/UDP Filter 2	8E _H	
TUF3	TCP/UDP Filter 3	8F _H	
TUF4	TCP/UDP Filter 4	90 _H	
TUF5	TCP/UDP Filter 5	91 _H	
TUF6	TCP/UDP Filter 6	92 _H	
TUF7	TCP/UDP Filter 7	93 _H	
TFA	Type Filter Action	94 _H	150
PFA	Protocol Filter Action	95 _H	151
TUA0	TCP/UDP Action 0	96 _H	152
TUA1	TCP/UDP Action 1	97 _H	153
TUA2	TCP/UDP Action 2	98 _H	154

Table 51 Registers Overview (cont'd)

Register Short Name	Register Long Name	Offset Address	Page Number
EICSTIC	Extended IGMP Control/Special Tag Insert Control	99 _H	155
IE	Interrupt Enable Register	9A _H	156
IS	Interrupt Status Register	9B _H	157
SC	Security Control Register	9C _H	157
CI0	Chip Identifier 0	A0 _H	158
CI1	Chip Identifier 1	A1 _H	158
PS0	Port Status 0	A2 _H	158
PS1	Port Status 1	A3 _H	159
PS2	Port Status 2	A4 _H	160
PS3	Port Status 3	A5 _H	161
CB0	Cable Broken 0	A6 _H	161
CB1	Cable Broken 1	A7 _H	162
CL0	Port 0 Receive Packet Counter Low	A8 _H	162
CH0	Port 0 Receive Packet Counter High	A9 _H	163
CL1	Port 1 Receive Packet Counter Low	AC _H	
CH1	Port 1 Receive Packet Counter High	AD _H	
CL2	Port 2 Receive Packet Counter Low	B0 _H	
CH2	Port 2 Receive Packet Counter High	B1 _H	
CL3	Port 3 Receive Packet Counter Low	B4 _H	
CH3	Port 3 Receive Packet Counter High	B5 _H	
CL4	Port 4 Receive Packet Counter Low	B6 _H	
CH4	Port 4 Receive Packet Counter High	B7 _H	
CL5	Port 5 Receive Packet Counter Low	B8 _H	
CH5	Port 5 Receive Packet Counter High	B9 _H	
CL6	Port 0 Receive Packet Byte Count Low	BA _H	
CH6	Port 0 Receive Packet Byte Count High	BB _H	
CL7	Port 1 Receive Packet Byte Count Low	BE _H	
CH7	Port 1 Receive Packet Byte Count High	BF _H	
CL8	Port 2 Receive Packet Byte Count Low	C2 _H	
CH8	Port 2 Receive Packet Byte Count High	C3 _H	
CL9	Port 3 Receive Packet Byte Count Low	C6 _H	
CH9	Port 3 Receive Packet Byte Count High	C7 _H	
CL10	Port 4 Receive Packet Byte Count Low	C8 _H	
CH10	Port 4 Receive Packet Byte Count High	C9 _H	
CL11	Port 5 Receive Packet Byte Count Low	CA _H	
CH11	Port 5 Receive Packet Byte Count High	CB _H	
CL12	Port 0 Transmit Packet Count Low	CC _H	
CH12	Port 0 Transmit Packet Count High	CD _H	
CL13	Port 1 Transmit Packet Count Low	D0 _H	
CH13	Port 1 Transmit Packet Count High	D1 _H	
CL14	Port 2 Transmit Packet Count Low	D4 _H	

Table 51 Registers Overview (cont'd)

Register Short Name	Register Long Name	Offset Address	Page Number
CH14	Port 2 Transmit Packet Count High	D5 _H	
CL15	Port 3 Transmit Packet Count Low	D8 _H	
CH15	Port 3 Transmit Packet Count High	D9 _H	
CL16	Port 4 Transmit Packet Count Low	DA _H	
CH16	Port 4 Transmit Packet Count High	DB _H	
CL17	Port 5 Transmit Packet Count Low	DC _H	
CH17	Port 5 Transmit Packet Count High	DD _H	
CL18	Port 0 Transmit Packet Byte Count Low	DE _H	
CH18	Port 0 Transmit Packet Byte Count High	DF _H	
CL19	Port 1 Transmit Packet Byte Count Low	E2 _H	
CH19	Port 1 Transmit Packet Byte Count High	E3 _H	
CL20	Port 2 Transmit Packet Byte Count Low	E6 _H	
CH20	Port 2 Transmit Packet Byte Count High	E7 _H	
CL21	Port 3 Transmit Packet Byte Count Low	EA _H	
CH21	Port 3 Transmit Packet Byte Count High	EB _H	
CL22	Port 4 Transmit Packet Byte Count Low	EC _H	
CH22	Port 4 Transmit Packet Byte Count High	ED _H	
CL23	Port 5 Transmit Packet Byte Count Low	EE _H	
CH23	Port 5 Transmit Packet Byte Count High	EF _H	
CL24	Port 0 Collision Count Low	F0 _H	
CH24	Port 0 Collision Count High	F1 _H	
CL25	Port 1 Collision Count Low	F4 _H	
CH25	Port 1 Collision Count High	F5 _H	
CL26	Port 2 Collision Count Low	F8 _H	
CH26	Port 2 Collision Count High	F9 _H	
CL27	Port 3 Collision Count Low	FC _H	
CH27	Port 3 Collision Count High	FD _H	
CL28	Port 4 Collision Count Low	FE _H	
CH28	Port 4 Collision Count High	FF _H	
CL29	Port 5 Collision Count Low	100 _H	
CH29	Port 5 Collision Count High	101 _H	
CL30	Port 0 Error Count Low	102 _H	
CH30	Port 0 Error Count High	103 _H	
CL31	Port 1 Error Count Low	106 _H	
CH31	Port 1 Error Count High	107 _H	
CL32	Port 2 Error Count Low	10A _H	
CH32	Port 2 Error Count High	10B _H	
CL33	Port 3 Error Count Low	10E _H	
CH33	Port 3 Error Count High	10F _H	
CL34	Port 4 Error Count Low	110 _H	
CH34	Port 4 Error Count High	111 _H	

Table 51 Registers Overview (cont'd)

Register Short Name	Register Long Name	Offset Address	Page Number
CL35	Port 5 Error Count Low	112 _H	
CH35	Port 5 Error Count High	113 _H	
OFF0	Over-Flow Flag 0	114 _H	165
OFF1	Over-Flow Flag 1	115 _H	166
OFF2	Over-Flow Flag 2	116 _H	166
OFF3	Over-Flow Flag 3	117 _H	167
OFF4	Over-Flow Flag 4	118 _H	168
OFF5	Over-Flow Flag 5	119 _H	169
HSL	Hardware Setting Low Register	130 _H	169
HSR	Hardware Setting High Register	131 _H	170
AA1	Assign Address [15:0] Register	132 _H	171
AA2	Assign Address [31:16] Register	133 _H	171
AA3	Assign Address [47:32] Register	134 _H	172
AO	Assign Option Register	135 _H	172
MIRR0	Mirror Register 0	136 _H	173
MIRR1	Mirror Register 1	137 _H	174
SVP	Security Violation Port	138 _H	175
SS0	Security Status 0	139 _H	175
SS1	Security Status 1	13A _H	176
FLAS	First Lock Address Search	13B _H	176
FLA1	First Lock Address [15:0]	13C _H	177
FLA2	First Lock Address [31:16]	13D _H	177
FLA3	First Lock Address [47:32]	13E _H	177
FLF	First Lock FID	13F _H	178
CCL	Counter Control Low Register	140 _H	178
CCH	Counter Control High Register	141 _H	179
CSL	Counter Status Low Register	142 _H	179
CSH	Counter Status High Register	143 _H	179
PHY_C0	PHY Control Register of Port 0	200 _H	180
PHY_S0	PHY Status Register of Port 0	201 _H	182
PHY_I0_A	PHY Identifier Register of Port 0 (A)	202 _H	183
PHY_I0_B	PHY Identifier Register of Port 0 (B)	203 _H	184
ANAP0	Auto Negotiation Advertisement Register of Port 0	204 _H	185
ANLPA0	Auto Negotiation Link Partner Ability Register of Port 0	205 _H	186
ANE0	Auto Negotiation Expansion Register of Port 0	206 _H	187
NPT0	Next Page Transmit Register of Port 0	207 _H	188
LPNP0	Link Partner Next Page Register of Port 0	208 _H	189
PHY_C1	PHY Control Register of Port 1	220 _H	
PHY_S1	PHY Status Register of Port 1	221 _H	
PHY_I1_A	PHY Identifier Register of Port 1 (A)	222 _H	

Table 51 Registers Overview (cont'd)

Register Short Name	Register Long Name	Offset Address	Page Number
PHY_I1_B	PHY Identifier Register of Port 1 (B)	223 _H	
ANAP1	Auto Negotiation Advertisement Register of Port 1	224 _H	
ANLPA1	Auto Negotiation Link Partner Ability Register of Port 1	225 _H	
ANE1	Auto Negotiation Expansion Register of Port 1	226 _H	
NPT1	Next Page Transmit Register of Port 1	227 _H	
LPNP1	Link Partner Next Page Register of Port 1	228 _H	
PHY_C2	PHY Control Register of Port 2	240 _H	
PHY_S2	PHY Status Register of Port 2	241 _H	
PHY_I2_A	PHY Identifier Register of Port 2 (A)	242 _H	
PHY_I2_B	PHY Identifier Register of Port 2 (B)	243 _H	
ANAP2	Auto Negotiation Advertisement Register of Port 2	244 _H	
ANLPA2	Auto Negotiation Link Partner Ability Register of Port 2	245 _H	
ANE2	Auto Negotiation Expansion Register of Port 2	246 _H	
NPT2	Next Page Transmit Register of Port 2	247 _H	
LPNP2	Link Partner Next Page Register of Port 2	248 _H	
PHY_C3	PHY Control Register of Port 3	260 _H	
PHY_S3	PHY Status Register of Port 3	261 _H	
PHY_I3_A	PHY Identifier Register of Port 3 (A)	262 _H	
PHY_I3_B	PHY Identifier Register of Port 3 (B)	263 _H	
ANAP3	Auto Negotiation Advertisement Register of Port 3	264 _H	
ANLPA3	Auto Negotiation Link Partner Ability Register of Port 3	265 _H	
ANE3	Auto Negotiation Expansion Register of Port 3	266 _H	
NPT3	Next Page Transmit Register of Port 3	267 _H	
LPNP3	Link Partner Next Page Register of Port 3	268 _H	
PHY_C4	PHY Control Register of Port 4	280 _H	
PHY_S4	PHY Status Register of Port 4	281 _H	
PHY_I4_A	PHY Identifier Register of Port 4 (A)	282 _H	
PHY_I4_B	PHY Identifier Register of Port 4 (B)	283 _H	
ANAP4	Auto Negotiation Advertisement Register of Port 4	284 _H	
ANLPA4	Auto Negotiation Link Partner Ability Register of Port 4	285 _H	
ANE4	Auto Negotiation Expansion Register of Port 4	286 _H	
NPT4	Next Page Transmit Register of Port 4	287 _H	
LPNP4	Link Partner Next Page Register of Port 4	288 _H	

The register is addressed wordwise.

Table 52 Register Access Types

Mode	Symbol	Description HW	Description SW
read/write	rw	Register is used as input for the HW	Register is readable and writable by SW
read	r	Register is written by HW (register between input and output -> one cycle delay)	Value written by software is ignored by hardware; that is, software may write any value to this field without affecting hardware behavior (= Target for development.)
Read only	ro	Register is set by HW (register between input and output -> one cycle delay)	SW can only read this register
Read virtual	rv	Physically, there is no new register, the input of the signal is connected directly to the address multiplexer.	SW can only read this register
Latch high, self clearing	lhsc	Latches high signal at high level, cleared on read	SW can read the register
Latch low, self clearing	llsc	Latches high signal at low-level, cleared on read	SW can read the register
Latch high, mask clearing	lhmk	Latches high signal at high level, register cleared with written mask	SW can read the register, with write mask the register can be cleared (1 clears)
Latch low, mask clearing	llmk	Latches high signal at low-level, register cleared on read	SW can read the register, with write mask the register can be cleared (1 clears)
Interrupt high, self clearing	ihsc	Differentiates the input signal (low->high) register cleared on read	SW can read the register
Interrupt low, self clearing	ilsc	Differentiates the input signal (high->low) register cleared on read	SW can read the register
Interrupt high, mask clearing	ihmk	Differentiates the input signal (high->low) register cleared with written mask	SW can read the register, with write mask the register can be cleared
Interrupt low, mask clearing	ilmk	Differentiates the input signal (low->high) register cleared with written mask	SW can read the register, with write mask the register can be cleared
Interrupt enable register	ien	Enables the interrupt source for interrupt generation	SW can read and write this register
latch_on_reset	lor	rw register, value is latched after first clock cycle after reset	Register is readable and writable by SW
Read/write self clearing	rwsc	Register is used as input for the hw, the register will be cleared due to a HW mechanism.	Writing to the register generates a strobe signal for the HW (1 pdi clock cycle) Register is readable and writable by SW.

Table 53 Registers Clock Domains

Clock Short Name	Description
–	–

4.1 EEPROM Basic Registers

Signature Register

SIG	Offset	Reset Value
Signature Register	00 _H	4154 _H

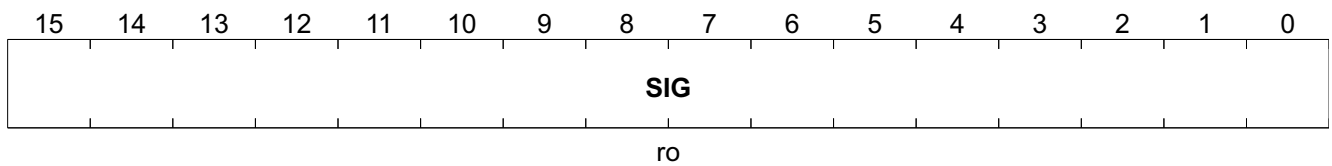

Field	Bits	Type	Description
SIG	15:0	ro	Signature The value must be 4154 _H . Samurai-6M/6MX (ADM6996M/MX) uses this value to check if EEPROM is attached. If the value in the EEPROM is not equal to 4154 _H , Samurai-6M/6MX (ADM6996M/MX) will stop loading the EEPROM even if EEPROM is attached and Samurai-6M/6MX (ADM6996M/MX) will use the default value inside the chip to initialize.

P0 Basic Control Register

P0BC	Offset	Reset Value
P0 Basic Control Register	01 _H	040F _H

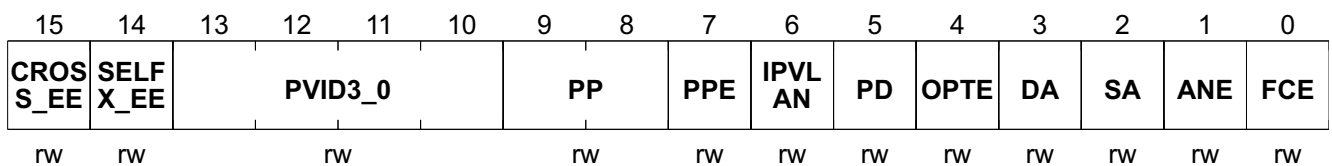

Field	Bits	Type	Description
CROSS_EE	15	rw	<p>Crossover Auto Detect Enable</p> <p>This bit is used together with the value (cross_hw) on the pin EESK/SDC during the power on reset and the value (wait_init) on the pin WAIT_INIT during the normal mode to decide if PHY enables this function. This bit is useless in Port 5.</p> <p>Combine with wait_init and cross_hw, the crossover auto detect capability is summarized as below :</p> <p>{wait_init, cross_hw, cross_ee} Description</p> <p>1x1_B , This port will enable Crossover Auto Detect Enable function</p> <p>1x0_B , This port will disable Crossover Auto Detect Enable function</p> <p>01x_B , This port will enable Crossover Auto Detect Enable function</p> <p>000_B , This port will disable Crossover Auto Detect Enable function</p> <p>001_B , This port will enable Crossover Auto Detect Enable function</p>
SELFX_EE	14	rw	<p>Select FX</p> <p>This bit is used together with the value (p4fx_hw) on the pin P4FX during the power on reset to decide if the PHY operates on the fiber mode. This bit is useless in Port 5. Port 0, 1, 2, 3: follow selfx_ee Description and Port 4: follow {p4fx_hw, selfx_ee} Description</p> <p>1x_B , Port 4: Port 4 will operate in the fiber mode</p> <p>00_B , Port 4: Port 4 will operate in the twisted mode</p> <p>01_B , Port 4: Port 4 will operate in the fiber mode</p>
PVID3_0	13:10	rw	<p>Private VID</p> <p>See 0028_H ~ 002C_H to find the other PVID [11:4]</p>
PP	9:8	rw	<p>Port Priority</p> <p>00_B , Assign packets to Queue 0</p> <p>01_B , Assign packets to Queue 1</p> <p>10_B , Assign packets to Queue 2</p> <p>11_B , Assign packets to Queue 3</p>
PPE	7	rw	<p>Port Priority Enable</p> <p>0_B , The port priority is disabled</p> <p>1_B , The port priority is enabled</p>
IPVLAN	6	rw	<p>IP over VLAN PRI</p> <p>0_B , Use the priority bits in the tag header to assign the priority queue</p> <p>1_B , Use the IP PRI to assign the priority queue</p>
PD	5	rw	<p>Port Disable</p> <p>0_B , Port 0, 1, 2, 3, 4: PHY works normally. Port 5: Port 5 works normally</p> <p>1_B , Port 0, 1, 2, 3, 4. PHY is disabled. Port 5: Port 5 is forced to link down</p>
OPTE	4	rw	<p>Output Packet Tagging Enable</p> <p>0_B , Untagged packets are transmitted</p> <p>1_B , Tagged packets are transmitted</p>
DA	3	rw	<p>Duplex Ability</p> <p>It is useless in Port 5.</p> <p>0_B , Recommend PHY to work in the half duplex mode</p> <p>1_B , Recommend PHY to work in the full duplex mode</p>

Registers Description

Field	Bits	Type	Description
SA	2	rw	Speed Ability 0 _B , Recommend PHY to work in the 10M mode 1 _B , Recommend PHY to work in the 100M mode
ANE	1	rw	Auto Negotiation Enable 0 _B , Recommend PHY to work without Auto Negotiation 1 _B , Recommend PHY to work with Auto Negotiation, when the value on the pin DUPCOL0 during the power on reset is 1
FCE	0	rw	Flow Control Enable 0 _B , Recommend MAC to work without Pause or Back Pressure 1 _B , In full duplex, recommend MAC to work with Pause when the value on the TXD0 during the power on reset is 1. In half duplex, recommend MAC to work with Back Pressure when the value on the DUPCOL2 during the power on reset is 1

Similar Registers

Table 54 P1~P5 Basic Control Registers

Register Short Name	Register Long Name	Offset Address	Page Number
P1BC	P1 Basic Control Register	03 _H	
P2BC	P2 Basic Control Register	05 _H	
P3BC	P3 Basic Control Register	07 _H	
P4BC	P4 Basic Control Register	08 _H	
P5BC	P5 Basic Control Register	09 _H	

P0 Extended Control Register

P0EC **Offset**
P0 Extended Control Register **02_H** **Reset Value**
0000_H

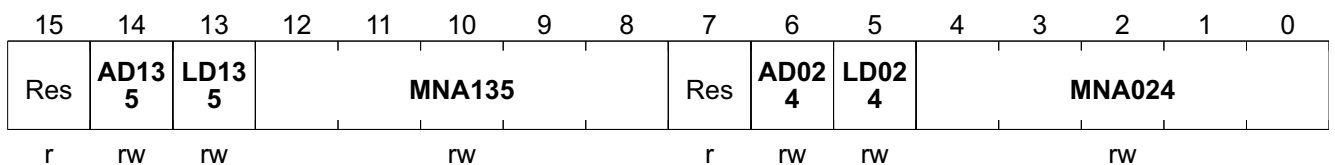

Field	Bits	Type	Description
Res	15	r	Reserved
AD135	14	rw	Ageing Disable P1, P3, and P5. 0 _B , Ageing function is enabled 1 _B , Ageing function is disabled
LD135	13	rw	Learning Disable P1, P3, and P5. 0 _B , Learning function is enabled 1 _B , Learning function is disabled

Registers Description

Field	Bits	Type	Description
MNA135	12:8	rw	Maximum Number of Addresses Learned from the port (P1, P3, and P5). <i>Note: set value to Others = limit the number of addresses to be learned.</i> 00000 _B , Doesn't limit the number of addresses to be learned
Res	7	r	Reserved
AD024	6	rw	Aging Disable P0, P2, and P4. 0 _B , Aging function is enabled. 1 _B , Aging function is disabled.
LD024	5	rw	Learning Disable P0, P2, and P4. 0 _B , Learning function is enabled. 1 _B , Learning function is disabled.
MNA024	4:0	rw	Maximum Number of Addresses Learned from the port (P0, P2, and P4). <i>Note: set value to Others = limit the number of addresses to be learned.</i> 00000 _B , Doesn't limit the number of addresses to be learned

Similar Registers

Table 55 Px_EC Registers

Register Short Name	Register Long Name	Offset Address	Page Number
P1EC	P1 Extended Control Register	02 _H	
P2EC	P2 Extended Control Register	04 _H	
P3EC	P3 Extended Control Register	04 _H	
P4EC	P4 Extended Control Register	06 _H	
P5EC	P5 Extended Control Register	06 _H	

System Control Register 0

SC0 **Offset**
System Control Register 0 **0A_H** **Reset Value**
5902_H

15	14	13	12	11	10	9	8	7	6	5	4	3	2	1	0
ERCMPH			PCR	PCE	RVID 0	RVID 1	RVID FFF	DFID			NTTE	TU	PM		
rw			rw	rw	rw	rw	rw	rw			rw	rw	rw		

Field	Bits	Type	Description
ERCMPH	15:12	rw	Earlier Cycles for Transmission It means the earlier cycles for transmission used in Samurai-6M/6MX (ADM6996M/MX). It is for the engineer debug purpose.

Registers Description

Field	Bits	Type	Description
PCR	11	rw	Priority Change Rule 0 _B , Use VLAN_PRI field in the matched VLAN filter 1 _B , Reverse PRI in the same way as untagged packet
PCE	10	rw	Priority Change Enable 0 _B , Do not change the priority in the tag header 1 _B , Change the priority field in the tag header
RVID0	9	rw	Replace VID0 0 _B , Do not replace 1 _B , Replace
RVID1	8	rw	Replace VID1 0 _B , Do not replace 1 _B , Replace
RVIDFFF	7	rw	Replace VIDFFF 0 _B , Do not replace 1 _B , Replace
DFID	6:3	rw	Default FID See Chapter 3.1.14.7 FID and VLAN Boundary for more detailed information.
NTTE	2	rw	New Transmit Tag Enable 0 _B , Use old 1 _B , Use new
TU	1	rw	TOS Using 0 _B , Use the most significant 6 bits of the TOS field in the IPV4 header to map the priority queue 1 _B , Use the most significant 3 bits of the TOS field in the IPV4 header to map the priority queue
PM	0	rw	PPPOE Manage When the port is configured as PPPOE Only, the port will only transmit the PPPOE packets. But when the packet is a management one, users could configure PPPOE Manage to 1 _B to transmit this packet on the PPPOE Only port even if it is not a PPPOE packet. Samurai-6M/6MX (ADM6996M/MX) identifies packets with Ether-Type = 8863 _H or 8864 _H as the PPPOE packet.

System Control Register 1

SC1		Offset		Reset Value											
System Control Register 1		0B _H		8001 _H											
15	14	13	12	11	10	9	8	7	6	5	4	3	2	1	0
DFEFD	IF	ASC	SIC	SIM	SIA	CMS	TE	TSIE	CPDC	SVOR	SVOA	SVOS	SVOD	NE	
rw	rw	rw	rw	rw	rw	rw	rw	rw	rw	rw	rw	rw	rw	rw	rw

Field	Bits	Type	Description
DFEFD	15	rw	Disable Far-End-Fault Detection 0 _B , Far-End-Fault detect ion is enabled 1 _B , Far-End-Fault detect ion is disabled
IF	14	rw	Input Filter 0 _B , Discardes packets directly when storming or the lack of input buffers 1 _B , Forwardes packets to the un-congested port when storming or the lack of input buffers
ASC	13:12	rw	Additional Snooping Control These bits are used when the packets on the incoming port with the Ethernet destination address = 01005Exxxxxx _H /3333xxxxxx _H are not IGMP_IP/ MLD_IPV/MLD_IPV6 packets and not found in the learning table or the hardware IGMP table. 00 _B , As normal multicast packets 01 _B , Dropped 10 _B , Send to CPU if the receiving port is non-CPU port or send to Multicast Portmap if the receiving is the CPU port 11 _B , Reserved
SIC	11	rw	Source Intrusion Condition 0 _B , Learning table source violation does not consider the port match 1 _B , Learning table source violation takes the port match into consideration
SIM	10	rw	Source Intrusion Must 0 _B , Learning table source violation will be effective in the following conditions. (1) The packets are not the management packets. (2) The packets are the management packets but Source Violation Over Reserve (SVOR) is 1 _B 1 _B , Must follow the learning table source violation rules
SIA	9	rw	Source Intrusion Action 0 _B , Discarded 1 _B , Send to the CPU port
CMS	8	rw	Carrier Mask Select (Reserved for test) 0 _B , Mask CRS of 4 Cycles 1 _B , Mask CRS of 5 Cycles
TE	7	rw	Port 3 and Port 4 Trunk Enable 0 _B , No trunk is enabled 1 _B , Port 3 and Port 4 are trunked
TSIE	6	rw	Transmit Short IPG Enable 0 _B , 96 bits time of IPG is used 1 _B , 88/96 bits time of IPG is used
CPDC	5	rw	CPU Port Doesn' t Check CPU Port doesn' t check CRC, for packets with Special Tag. 0 _B , Checks 1 _B , Doesn't Check

Registers Description

Field	Bits	Type	Description
SVOR	4	rw	Source Violation Over Reserve This bit is used when the management packet with DA = 0180C20000xx _H violates the source rule. 0 _B , Source violation doesn't change the forwarding algorithm 1 _B , Source violation will change the forwarding algorithm
SVOA	3	rw	Source Violation Over ARP/RARP This bit is used when the ARP/RARP packet classified as management that violates the source rule. 0 _B , Source violation doesn't change the forwarding algorithm 1 _B , Source violation will change the forwarding algorithm
SVOS	2	rw	Source Violation Over Snooping This bit is used when the MLD_IPV6/MLD_IP/IGMP/IP packet classified as management that violates the source rule. 0 _B , Source violation doesn't change the forwarding algorithm 1 _B , Source violation will change the forwarding algorithm
SVOD	1	rw	Source Violation Over Default This bit is used when the packet that is not the same as the above and it is classified as management that violates the source rule. 0 _B , Source violation doesn't change the forwarding algorithm 1 _B , Source violation will change the forwarding algorithm
NE	0	rw	New EEPROM 0 _B , Use old EEPROM functions 1 _B , New EEPROM function is enabled

Multicast Snooping Register

MS Offset Reset Value
Multicast Snooping Register 0C_H 0000_H

15	14	13	12	11	10	9	8	7	6	5	4	3	2	1	0
SCPA	SCPPE	SCPP	SCPTTH	SCPTC	SCPTM	SCPTS	TMI6P	TMIP	TIP	HIPI	HISE	HIDRE			
rw	rw	rw	rw	rw	rw	rw	rw	rw	rw	rw	rw	rw	rw	rw	rw

Field	Bits	Type	Description
SCPA	15:14	rw	Snooping Control Packet Action 00 _B , IGMP Portmap is 000000 _B 01 _B , IGMP Portmap is the Multicast Portmap 10 _B , If the incoming port is not the CPU port, then the IGMP Portmap is the CPU port. If the incoming port is the CPU port, then the IGMP Portmap is the Multicast Portmap except the CPU port 11 _B , If the incoming port is not the CPU port, then the Multicast Portmap is the CPU port. If the incoming port is the CPU port, then the Multicast Portmap is the default output ports except the CPU port

Registers Description

Field	Bits	Type	Description
SCPPE	13	rw	Snooping Control Packet Priority Enable 0 _B , Disable 1 _B , Enable
SCPP	12:11	rw	Snooping Control Packet Priority 00 _B , Queue 0 01 _B , Queue 1 10 _B , Queue 2 11 _B , Queue 3
SCPTTH	10:9	rw	Snooping Control Packet Transmission Tag Handle 00 _B , System Default Tag 01 _B , Unmodified 10 _B , Always Tagged 11 _B , Always Untagged
SCPTC	8	rw	Snooping Control Packet Treated as Cross_VLAN Packet 0 _B , Doesn't identify 1 _B , Identifies as the cross_VLAN packet
SCPTM	7	rw	Snooping Control Packet Treated as Management Packet 0 _B , Doesn't identify 1 _B , Identifies as the management packet
SCPTS	6	rw	Snooping Control Packet Treated as Span Packet 0 _B , Doesn't identify 1 _B , Identifies as the span packet
TM16P	5	rw	Trap MLD_IPV6 Packet 0 _B , Doesn't trap 1 _B , Traps
TMIP	4	rw	Trap MLD_IP Packet 0 _B , Doesn't trap 1 _B , Traps
TIP	3	rw	Trap IGMP_IP Packet 0 _B , Doesn't Trap 1 _B , Trasp
HIPI	2	rw	Hardware IGMP Packet Ignore CPU Port 0 _B , IGMP packet forwards to CPU also when Hardware IGMP Snooping is enabled 1 _B , IGMP packet doesn't forward to CPU when Hardware IGMP Snooping is enabled
HISE	1	rw	Hardware IGMP Snooping Enable 0 _B , Disable Hardware IGMP Snooping 1 _B , Enable Hardware IGMP Snooping
HIDRE	0	rw	Hardware IGMP Default Router Enable 0 _B , Disable 1 _B , Enable

Registers Description

Field	Bits	Type	Description
APT	4	rw	ARP Packet Treated as Cross _ VLAN Packet 0 _B , Doesn't identify 1 _B , Identifies as the cross_VLAN packet
RAPTM	3	rw	RARP/ARP Packet Treated as Management Packet 0 _B , Doesn't identify 1 _B , Identifies as the management packet
TAPTS	2	rw	RARP/ARP Packet Treated as Span Packet 0 _B , Doesn't identify 1 _B , Identifies as the span packet
TAP	1	rw	Trap ARP Packet 0 _B , Doesn't Trap 1 _B , Traps
TRP	0	rw	Trap RARP Packet 0 _B , Doesn't Trap 1 _B , Traps

VLAN Priority Map Register

VPM **Offset** **Reset Value**
VLAN Priority Map Register **0E_H** **FA50_H**

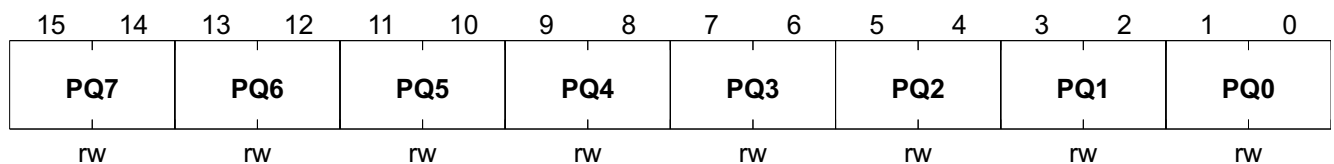

Field	Bits	Type	Description
PQ7	15:14	rw	Priority Queue 7 These 2 bits are used as the priority queue when the tagged packets with the user priority = 111 _B are received on the port. 00 _B , Queue 0 01 _B , Queue 1 10 _B , Queue 2 11 _B , Queue 3
PQ6	13:12	rw	Priority Queue 6 These 2 bits are used as the priority queue when the tagged packets with the user priority = 110 _B are received on the port.
PQ5	11:10	rw	Priority Queue 5 These 2 bits are used as the priority queue when the tagged packets with the user priority = 101 _B are received on the port.
PQ4	9:8	rw	Priority Queue 4 These 2 bits are used as the priority queue when the tagged packets with the user priority = 100 _B are received on the port.

Registers Description

Field	Bits	Type	Description
PQ3	7:6	rw	Priority Queue 3 These 2 bits are used as the priority queue when the tagged packets with the user priority = 011 _B are received on the port.
PQ2	5:4	rw	Priority Queue 2 These 2 bits are used as the priority queue when the tagged packets with the user priority = 010 _B are received on the port.
PQ1	3:2	rw	Priority Queue 1 These 2 bits are used as the priority queue when the tagged packets with the user priority = 001 _B are received on the port.
PQ0	1:0	rw	Priority Queue 0 These 2 bits are used as the priority queue when the tagged packets with the user priority = 000 _B are received on the port.

TOS Priority Map Register

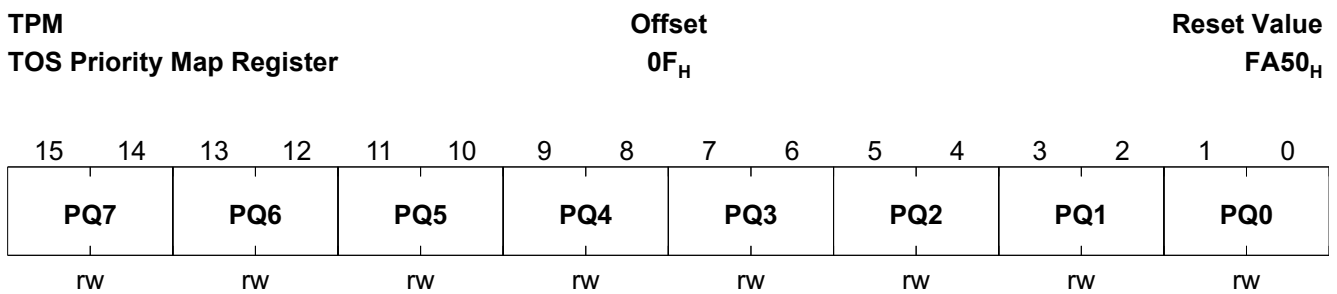

Field	Bits	Type	Description
PQ7	15:14	rw	Priority Queue 7 These 2 bits are used as the priority queue, when the most significant 3 bits in the TOS field are 111 _B 00 _B , Queue 0 01 _B , Queue 1 10 _B , Queue 2 11 _B , Queue 3
PQ6	13:12	rw	Priority Queue 6 These 2 bits are used as the priority queue, when the most significant 3 bits in the TOS field are 110 _B
PQ5	11:10	rw	Priority Queue 5 These 2 bits are used as the priority queue, when the most significant 3 bits in the TOS field are 101 _B
PQ4	9:8	rw	Priority Queue 4 These 2 bits are used as the priority queue, when the most significant 3 bits in the TOS field are 100 _B
PQ3	7:6	rw	Priority Queue 3 These 2 bits are used as the priority queue, when the most significant 3 bits in the TOS field are 011 _B

Registers Description

Field	Bits	Type	Description
PQ2	5:4	rw	Priority Queue 2 These 2 bits are used as the priority queue, when the most significant 3 bits in the TOS field are 010 _B
PQ1	3:2	rw	Priority Queue 1 These 2 bits are used as the priority queue, when the most significant 3 bits in the TOS field are 001 _B
PQ0	1:0	rw	Priority Queue 0 These 2 bits are used as the priority queue, when the most significant 3 bits in the TOS field are 000 _B

System Control Register 2

SC2 **Offset**
System Control Register 2 **10_H** **Reset Value**
0040_H

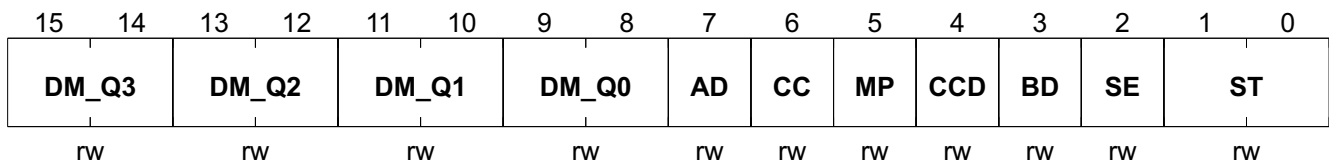

Field	Bits	Type	Description
DM_Q3	15:14	rw	Discard Mode Q3 Discard Mode (Drop scheme for Packets Classified as Q3) . See Chapter 3.1.11 Smart Discard for more detail information.
DM_Q2	13:12	rw	Discard Mode Q2 Discard Mode (Drop scheme for Packets Classified as Q2) . See Chapter 3.1.11 Smart Discard for more detail information.
DM_Q1	11:10	rw	Discard Mode Q1 Discard Mode (Drop scheme for Packets Classified as Q1) . See Chapter 3.1.11 Smart Discard for more detail information.
DM_Q0	9:8	rw	Discard Mode Q0 Discard Mode (Drop scheme for Packets Classified as Q0) . See Chapter 3.1.11 Smart Discard for more detail information.
AD	7	rw	Ageing Disable Useless in Samurai-6M/6MX (ADM6996M/MX) 0 _B , Age enabled 1 _B , Age disabled
CC	6	rw	Rx Clock Change to Tx Clock for GPSI Interface 0 _B , Samurai-6M/6MX (ADM6996M/MX) does not use Tx clock to replace Rx clock when Rx clock stops. 1 _B , Samurai-6M/6MX (ADM6996M/MX) uses Tx clock to replace Rx clock when Rx clock stops

Registers Description

Field	Bits	Type	Description
MP	5	rw	Multicast Packet Counted into the Storm Counter 0 _B , Only broadcast packets are counted into the storming counter 1 _B , Multicast and broadcast packets are counted into the storming counter
CCD	4	rw	CRC Check Disable 0 _B , Checks CRC 1 _B , Doesn't check CRC
BD	3	rw	Back Off Disable 0 _B , Back-off is enabled 1 _B , Back-off is disabled
SE	2	rw	Storming Enable It is used in ADM6996L/F style storm control. 0 _B , Disable broadcast/multicast storm protection. 1 _B , Enable broadcast/multicast storm protection.
ST	1:0	rw	Storming Threshold[1:0] It is used in ADM6996L/F style storm control.

System Control Register 3

SC3 **Offset** **Reset Value**
System Control Register 3 **11_H** **E300_H**

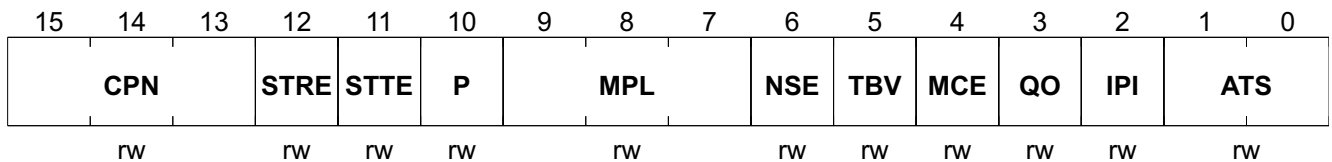

Field	Bits	Type	Description
CPN	15:13	rw	CPU Port Number 000 _B , The CPU is attached to Port 0 001 _B , The CPU is attached to Port 1 010 _B , The CPU is attached to Port 2 011 _B , The CPU is attached to Port 3 100 _B , The CPU is attached to Port 4 101 _B , The CPU is attached to Port 5 111 _B , No CPU exists
STRE	12	rw	Special TAG Receive Enable 0 _B , Samurai-6M/6MX (ADM6996M/MX) doesn't identify the Special TAG for the incoming packets 1 _B , Samurai-6M/6MX (ADM6996M/MX) identifies the Special TAG for the incoming packets

Registers Description

Field	Bits	Type	Description
STTE	11	rw	Special TAG Transmit Enable 0 _B , Samurai-6M/6MX (ADM6996M/MX) does not insert Special TAG for the packets transmitted to the CPU port 1 _B , Samurai-6M/6MX (ADM6996M/MX) inserts Special TAG for the packets transmitted to the CPU port.
P	10	rw	Pause Also adds Special Tag when Special TAG Transmit is enabled . 0 _B , Does not add Special Tag on the PAUSE packets 1 _B , Adds Special Tag in the PAUSE packets
MPL	9:7	rw	Max Packet Length 000 _B , 1518 bytes 001 _B , 1536 bytes 010 _B , 1664 bytes 110 _B , 1522 bytes x11 _B , 1784 bytes 10x _B , 1784 bytes
NSE	6	rw	New Storming Enable 0 _B , Uses the ADM6996L/F style storming control 1 _B , Uses the Samurai-6M/6MX (ADM6996M/MX) style storming control
TBV	5	rw	Tag Base VLAN 0 _B , Port VLAN 1 _B , Tagged VLAN
MCE	4	rw	MAC Clone Enable 0 _B , MAC Clone is disabled 1 _B , MAC Clone is enabled
QO	3	rw	Queue Option It' s the test for the designer in the queue control.
IPI	2	rw	Interrupt Polarity Inverter 0 _B , The interrupt signal is active pull low 1 _B , The interrupt signal is active pull high
ATS	1:0	rw	Aging Timer Select 00 _B , 300 Seconds 01 _B , 75 Seconds 10 _B , 18 Seconds 11 _B , 1 Second

System Control Register 4

SC4	Offset	Reset Value
System Control Register 4	12_H	3600_H

Registers Description

15	14	13	12	11	10	9	8	7	6	5	4	3	2	1	0
DP	DUP COL [*]	Res	TLE	Res	Res	O5FL	O4FL	O3FL	PI	O2FL	DUAL [*]	O1FL	LED [*]	O0FL	
rw	rw	rw	rw	rw	rw	rw	rw	rw	rw	rw	rw	rw	rw	rw	

Field	Bits	Type	Description
DP	15	rw	Drop Packet When Excessive Collision Happen 0 _B , Doesn't drop 1 _B , Drops
DUP_COL_SE P	14	rw	Duplex and Col Separate 0 _B , Indicates the duplex and collision status at the same time 1 _B , Indicates the duplex status only
Res	13:12	rw	Reserved
TLE	11	rw	Ten Limit Enable This function works only when Full Flow Control/Half Back Pressure is enabled. 0 _B , The switch will not ignore 10 Mbit/s paths even when the ten limit reaches 1 _B , The switch will forward packets with Multicast, Broadcast, or Unicast but not learned DA addresses from 100 Mbit/s only to 100 Mbit/s ports and ignore the 10M paths when the ten limit reaches. This function allows the switch to balance the high and the low speed
Res	10	rw	Reserved
Res	9	rw	Reserved
O5FL	8	rw	OLD P5 First Lock 0 _B , First Lock is disabled 1 _B , First Lock is enabled
O4FL	7	rw	OLD P4 First Lock 0 _B , First Lock is disabled 1 _B , First Lock is enabled
O3FL	6	rw	OLD P3 First Lock 0 _B , First Lock is disabled 1 _B , First Lock is enabled
PI	5	rw	Pause Ignore 0 _B , Doesn't ignore Pause packets 1 _B , Ignores Pause packets in half duplex or in full duplex when flow control is not enabled
O2FL	4	rw	OLD P2 First Lock 0 _B , First Lock is disabled 1 _B , First Lock is enabled
DUAL-COLOR-EE	3	rw	Dual Color in MDC / MDIO with CPU See Chapter 3.1.12 LED Display for more detailed information. 0 _B , Single Color 1 _B , Dual Color

Registers Description

Field	Bits	Type	Description
O1FL	2	rw	OLD P1 First Lock 0 _B , First Lock is disabled 1 _B , First Lock is enabled
LED-ENABLE	1	rw	LED Enable 0 _B , Disable 1 _B , Enable
O0FL	0	rw	OLD P0 First Lock 0 _B , First Lock is disabled 1 _B , First Lock is enabled

Port 0 Security Option

Port Spanning Tree State and Forward Group Port Map.

P0SO **Offset**
Port 0 Security Option **13_H** **Reset Value**
01D5_H

15	14	13	12	11	10	9	8	7	6	5	4	3	2	1	0
Res	CP	PSO		STPS		P5	P4	P3	Res	P2	Res	P1	Res	P0	
r	rw	rw		rw		rw	rw	rw	r	rw	r	rw	r	rw	

Field	Bits	Type	Description
Res	15	r	Reserved
CP	14	rw	Close Port 0 _B , Doesn't close the port 1 _B , When port security exists, the port is closed automatically
PSO	13:11	rw	Port Security Option 001 _B , Unknown to CPU 010 _B , Discard Unknown 011 _B , First Lock 100 _B , First Link Lock 101 _B , Assign Lock 110 _B , Assign Link Lock
STPS	10:9	rw	Spanning Tree Port Status The Samurai-6M/6MX (ADM6996M/MX) supports 4 port status to support Spanning Tree Protocol . 00 _B , Forwarding State. The port acts as the normal mode 01 _B , Disabled State . The port entity will not transmit and receive any packets. Learning is disabled in this state 10 _B , Learning State . The port entity will only transmit and receive span packets. All other packets are discarded. Learning is enabled for all good frames 11 _B , Blocking/Listening. Only the span packets defined by Samurai-6M/6MX (ADM6996M/MX) will be received and transmitted. All other packets are discarded by the port entity. Learning is disabled in this state

Registers Description

Field	Bits	Type	Description
P5	8	rw	Port 5 is a Member of the Forwarding Group 0 _B , Port 5 is not a member 1 _B , Port 5 is a member
P4	7	rw	Port 4 is a Member of the Forwarding Group 0 _B , Port 4 is not a member 1 _B , Port 4 is a member
P3	6	rw	Port 3 is a Member of the Forwarding Group 0 _B , Port 3 is not a member 1 _B , Port 3 is a member
Res	5	r	Reserved
P2	4	rw	Port 2 is a Member of the Forwarding Group 0 _B , Port 2 is not a member 1 _B , Port 2 is a member
Res	3	r	Reserved
P1	2	rw	Port 1 is a Member of the Forwarding Group 0 _B , Port 1 is not a member 1 _B , Port 1 is a member
Res	1	r	Reserved
P0	0	rw	Port 0 is a Member of the Forwarding Group 0 _B , Port 0 is not a member 1 _B , Port 0 is a member

Similar Registers

Table 56 PxSO Registers

Register Short Name	Register Long Name	Offset Address	Page Number
P1SO	Port 1 Security Option	14 _H	
P2SO	Port 2 Security Option	15 _H	
P3SO	Port 3 Security Option	16 _H	
P4SO	Port 4 Security Option	17 _H	
P5SO	Port 5 Security Option	18 _H	

Unicast Port Map and Forward Group Port Map

UFGPM **Offset** **Reset Value**
Unicast Port Map and Forward Group Port Map **19_H** **FFD5_H**

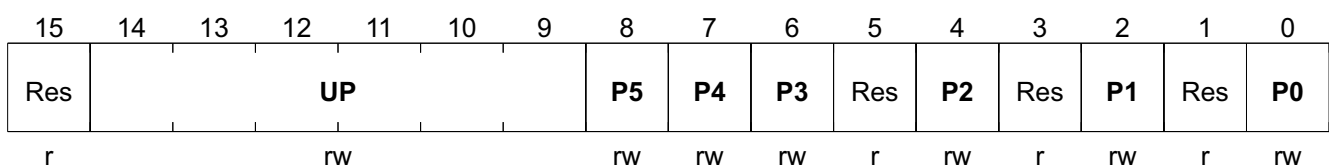

Registers Description

Field	Bits	Type	Description
P5	8	rw	Port 5 is a Member of the Forwarding Group 0 _B , Port 5 is not a member 1 _B , Port 5 is a member
P4	7	rw	Port 4 is a Member of the Forwarding Group 0 _B , Port 4 is not a member 1 _B , Port 4 is a member
P3	6	rw	Port 3 is a Member of the Forwarding Group 0 _B , Port 3 is not a member 1 _B , Port 3 is a member
Res	5	r	Reserved
P2	4	rw	Port 2 is a Member of the Forwarding Group 0 _B , Port 2 is not a member 1 _B , Port 2 is a member
Res	3	r	Reserved
P1	2	rw	Port 1 is a Member of the Forwarding Group 0 _B , Port 1 is not a member 1 _B , Port 1 is a member
Res	1	r	Reserved
P0	0	rw	Port 0 is a Member of the Forwarding Group 0 _B , Port 0 is not a member 1 _B , Port 0 is a member

Multicast Port Map and Forward Group Port Map

MFGPM **Offset** **Reset Value**
Multicast Port Map and Forward Group Port Map **1B_H** **FFD5_H**

	15	14	13	12	11	10	9	8	7	6	5	4	3	2	1	0
Res					MP			P5	P4	P3	Res	P2	Res	P1	Res	P0
	r				rw			rw	rw	rw	r	rw	r	rw	r	rw

Field	Bits	Type	Description
Res	15	r	Reserved
MP	14:9	rw	Multicast Portmap See Chapter 3.1.20 Packet Forwarding for more detailed information.
P5	8	rw	Port 5 is a member of the Forwarding Group 0 _B , Port 5 is not a member 1 _B , Port 5 is a member
P4	7	rw	Port 4 is a member of the Forwarding Group 0 _B , Port 4 is not a member 1 _B , Port 4 is a member

Registers Description

Field	Bits	Type	Description
P2	4	rw	Port 2 is a member of the Forwarding Group 0 _B , Port 2 is not a member 1 _B , Port 2 is a member
Res	3	r	Reserved
P1	2	rw	Port 1 is a member of the Forwarding Group 0 _B , Port 1 is not a member 1 _B , Port 1 is a member
Res	1	r	Reserved
P0	0	rw	Port 0 is a member of the Forwarding Group 0 _B , Port 0 is not a member 1 _B , Port 0 is a member

Packet Identification Option, Forward Group Port Map

PIOFGPM	Offset	Reset Value
Packet Identification Option, Forward Group Port Map	1D_H	FFD5_H

15	14	13	12	11	10	9	8	7	6	5	4	3	2	1	0
MSPH	DIVS	DII6P	DIIPS	DIE	DIIP	DIS	P5	P4	P3	Res	P2	Res	P1	Res	P0
rw	rw	rw	rw	rw	rw	rw	rw	rw	rw	r	rw	r	rw	r	rw

Field	Bits	Type	Description
MSPH	15	rw	MLD Snooping Protocol Header 0 _B , Protocol Header is 01 _H . 1 _B , Protocol Header is 3A _H .
DIVS	14	rw	Do not Identify VLAN after SNAP 0 _B , Identify 1 _B , Don't identify
DII6P	13	rw	Do not Identify IPV6 in PPPOE 0 _B , Identify 1 _B , Don't identify
DIIPS	12	rw	Do not Identify IP in PPPOE after SNAP 0 _B , Identify 1 _B , Don't identify
DIE	11	rw	Do not Identify Ether-Type = 0x0800, IP VER = 6 as IPV6 packets 0 _B , Identify 1 _B , Don't identify
DIIP	10	rw	Do not Identify IP in PPPOE 0 _B , Identify 1 _B , Don't identify

Registers Description

Field	Bits	Type	Description
DIS	9	rw	Do not Identify SNAP 0 _B , Identify 1 _B , Don't identify
P5	8	rw	Port 5 is a member of the Forwarding Group 0 _B , Port 5 is not a member 1 _B , Port 5 is a member
P4	7	rw	Port 4 is a member of the Forwarding Group 0 _B , Port 4 is not a member 1 _B , Port 4 is a member
P3	6	rw	Port 3 is a member of the Forwarding Group 0 _B , Port 3 is not a member 1 _B , Port 3 is a member
Res	5	r	Reserved
P2	4	rw	Port 2 is a member of the Forwarding Group 0 _B , Port 2 is not a member 1 _B , Port 2 is a member
Res	3	r	Reserved
P1	2	rw	Port 1 is a member of the Forwarding Group 0 _B , Port 1 is not a member 1 _B , Port 1 is a member
Res	1	r	Reserved
P0	0	rw	Port 0 is a member of the Forwarding Group 0 _B , Port 0 is not a member 1 _B , Port 0 is a member

VLAN Priority Enable and Forward Group Port Map

VPEFGPM	Offset	Reset Value
VLAN Priority Enable and Forward Group Port Map	1E _H	FFD5 _H

15	14	13	12	11	10	9	8	7	6	5	4	3	2	1	0
Res	VPE					P5	P4	P3	Res	P2	Res	P1	Res	P0	
r	rw					rw	rw	rw	r	rw	r	rw	r	rw	

Field	Bits	Type	Description
Res	15	r	Reserved
VPE	14:9	rw	VLAN Priority Enable 0 _B , Do not care the PRI in the tag header 1 _B , PRI in the tag header will be taken into priority determination consideration

Registers Description

Field	Bits	Type	Description
P5	8	rw	Port 5 is a member of the Forwarding Group 0 _B , Port 5 is not a member 1 _B , Port 5 is a member
P4	7	rw	Port 4 is a member of the Forwarding Group 0 _B , Port 4 is not a member 1 _B , Port 4 is a member
P3	6	rw	Port 3 is a member of the Forwarding Group 0 _B , Port 3 is not a member 1 _B , Port 3 is a member
Res	5	r	Reserved
P2	4	rw	Port 2 is a member of the Forwarding Group 0 _B , Port 2 is not a member 1 _B , Port 2 is a membe
Res	3	r	Reserved
P1	2	rw	Port 1 is a member of the Forwarding Group 0 _B , Port 1 is not a member 1 _B , Port 1 is a member
Res	1	r	Reserved
P0	0	rw	Port 0 is a member of the Forwarding Group 0 _B , Port 0 is not a member 1 _B , Port 0 is a member

Service Priority Enable and Forward Group Port Map

SPEFGPM **Offset** **Reset Value**
Service Priority Enable and Forward Group **1F_H** **FFD5_H**
Port Map

15	14	13	12	11	10	9	8	7	6	5	4	3	2	1	0
Res			SPE				P5	P4	P3	Res	P2	Res	P1	Res	P0
r			rw				rw	rw	rw	r	rw	r	rw	r	rw

Field	Bits	Type	Description
Res	15	r	Reserved
SPE	14:9	rw	Service Priority Enable 0 _B , Don't care IPV4 TOS /IPV6 Traffic Class 1 _B , Care IPV4 TOS/IPV6 Traffic for priority decision
P5	8	rw	Port 5 is a member of the Forwarding Group 0 _B , Port 5 is not a member 1 _B , Port 5 is a member
P4	7	rw	Port 4 is a member of the Forwarding Group 0 _B , Port 4 is not a member 1 _B , Port 4 is a member

Registers Description

Field	Bits	Type	Description
P3	6	rw	Port 3 is a member of the Forwarding Group 0 _B , Port 3 is not a member 1 _B , Port 3 is a member
Res	5	r	Reserved
P2	4	rw	Port 2 is a member of the Forwarding Group 0 _B , Port 2 is not a member 1 _B , Port 2 is a member
Res	3	r	Reserved
P1	2	rw	Port 1 is a member of the Forwarding Group 0 _B , Port 1 is not a member 1 _B , Port 1 is a member
Res	1	r	Reserved
P0	0	rw	Port 0 is a member of the Forwarding Group 0 _B , Port 0 is not a member 1 _B , Port 0 is a member

Input Force No Tag and Forward Group Port Map

IFNTFGPM **Offset** **Reset Value**
Input Force No Tag and Forward Group Port Map **20_H** **FFD5_H**

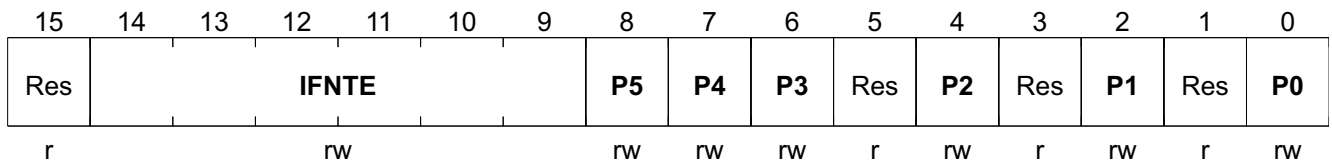

Field	Bits	Type	Description
Res	15	r	Reserved
IFNTE	14:9	rw	Input Force No TAG Enable 0 _B , Disabled 1 _B , Enabled
P5	8	rw	Port 5 is a member of the Forwarding Group 0 _B , Port 5 is not a member 1 _B , Port 5 is a member
P4	7	rw	Port 4 is a member of the Forwarding Group 0 _B , Port 4 is not a member 1 _B , Port 4 is a member
P3	6	rw	Port 3 is a member of the Forwarding Group 0 _B , Port 3 is not a member 1 _B , Port 3 is a member
Res	5	r	Reserved

Registers Description

Field	Bits	Type	Description
P2	4	rw	Port 2 is a member of the Forwarding Group 0 _B , Port 2 is not a member 1 _B , Port 2 is a member
Res	3	r	Reserved
P1	2	rw	Port 1 is a member of the Forwarding Group 0 _B , Port 1 is not a member 1 _B , Port 1 is a member
Res	1	r	Reserved
P0	0	rw	Port 0 is a member of the Forwarding Group 0 _B , Port 0 is not a member 1 _B , Port 0 is a member

Ingress Filter and Forward Group Port Map

IFFGPM **Offset** **Reset Value**
Ingress Filter and Forward Group Port Map **21_H** **FFD5_H**

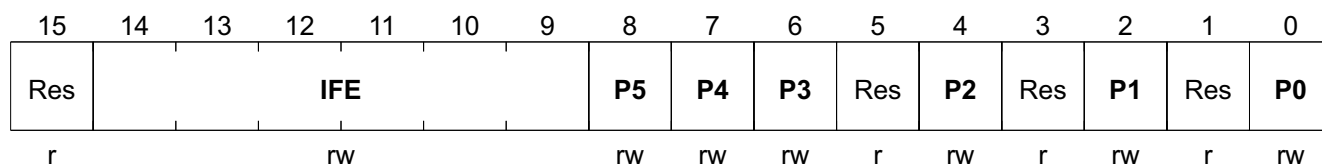

Field	Bits	Type	Description
Res	15	r	Reserved
IFE	14:9	rw	Ingress Filter Enable 0 _B , Doesn't filter 1 _B , Filters
P5	8	rw	Port 5 is a member of the Forwarding Group 0 _B , Port 5 is not a member 1 _B , Port 5 is a member
P4	7	rw	Port 4 is a member of the Forwarding Group 0 _B , Port 4 is not a member 1 _B , Port 4 is a member
P3	6	rw	Port 3 is a member of the Forwarding Group 0 _B , Port 3 is not a member 1 _B , Port 3 is a member
Res	5	r	Reserved
P2	4	rw	Port 2 is a member of the Forwarding Group 0 _B , Port 2 is not a member 1 _B , Port 2 is a member
Res	3	r	Reserved

Registers Description

Field	Bits	Type	Description
P1	2	rw	Port 1 is a member of the Forwarding Group 0 _B , Port 1 is not a member 1 _B , Port 1 is a member
Res	1	r	Reserved
P0	0	rw	Port 0 is a member of the Forwarding Group 0 _B , Port 0 is not a member 1 _B , Port 0 is a member

VLAN Security Disable and Forward Group Port Map

VSDFGPM **Offset** **Reset Value**
VLAN Security Disable and Forward Group **22_H** **FFD5_H**
Port Map

15	14	13	12	11	10	9	8	7	6	5	4	3	2	1	0
Res	VSD						P5	P4	P3	Res	P2	Res	P1	Res	P0
r	rw						rw	rw	rw	r	rw	r	rw	r	rw

Field	Bits	Type	Description
Res	15	r	Reserved
VSD	14:9	rw	VLAN Security Disable 0 _B , Do not disable 1 _B , Disable
P5	8	rw	Port 5 is a member of the Forwarding Group 0 _B , Port 5 is not a member 1 _B , Port 5 is a member
P4	7	rw	Port 4 is a member of the Forwarding Group 0 _B , Port 4 is not a member 1 _B , Port 4 is a member
P3	6	rw	Port 3 is a member of the Forwarding Group 0 _B , Port 3 is not a member 1 _B , Port 3 is a member
Res	5	r	Reserved
P2	4	rw	Port 2 is a member of the Forwarding Group 0 _B , Port 2 is not a member 1 _B , Port 2 is a member
Res	3	r	Reserved
P1	2	rw	Port 1 is a member of the Forwarding Group 0 _B , Port 1 is not a member 1 _B , Port 1 is a member
Res	1	r	Reserved

Registers Description

Field	Bits	Type	Description
P0	0	rw	Port 0 is a member of the Forwarding Group 0 _B , Port 0 is not a member 1 _B , Port 0 is a member

Buffer Threshold Register 0

BT0 **Offset** **Reset Value**
Buffer Threshold Register 0 **23_H** **0000_H**

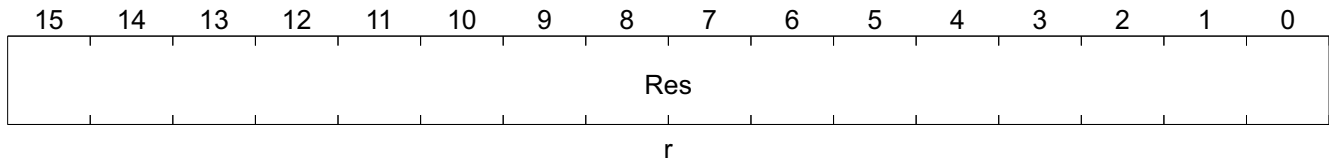

Field	Bits	Type	Description
Res	15:0	r	Reserved

Buffer Threshold Register 1

BT1 **Offset** **Reset Value**
Buffer Threshold Register 1 **24_H** **0000_H**

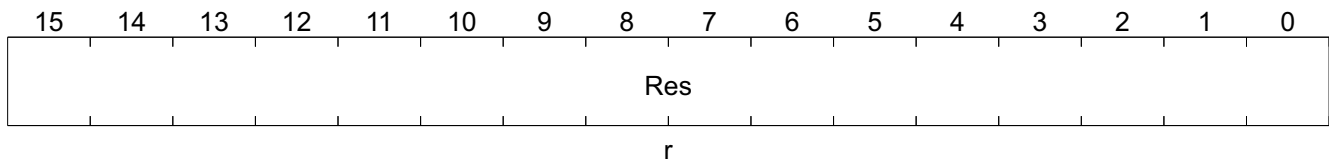

Field	Bits	Type	Description
Res	15:0	r	Reserved

IGMP/MLDTRAP Enable and Input Jam Threshold Register

IMEIJT **Offset** **Reset Value**
IGMP/MLDTRAP Enable and Input Jam **25_H** **1000_H**
Threshold Register

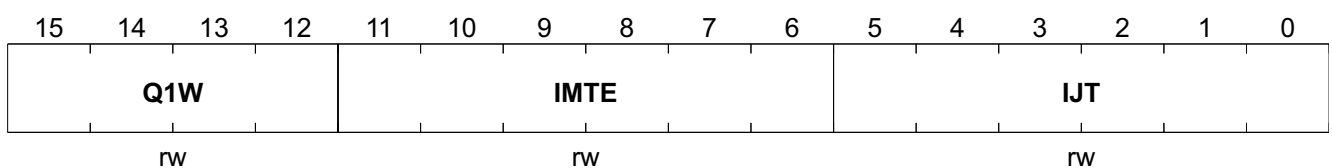

Registers Description

Field	Bits	Type	Description
Q1W	15:12	rw	Queue 1 Weight See Chapter 3.1.15 Priority Queue for more detail information.
IMTE	11:6	rw	IGMP/MLD Trap Enable It is a per port function. 0 _B , The port does not enable its multicast snooping function. Trap MLD_IPV6, MLD_IP and IGMP_IP are useless in this port 1 _B , The port enables its multicast snooping function. Trap MLD_IPV6, MLD_IP and IGMP_IP are useful in this port
IJT	5:0	rw	Input Jam Threshold

Queue 2 Weight, VID Exist Check, and PPPOE Port Only

Q2WVECPO	Offset	Reset Value
Queue 2 Weight, VID Exist Check, and PPPOE Port Only	26 _H	1000 _H

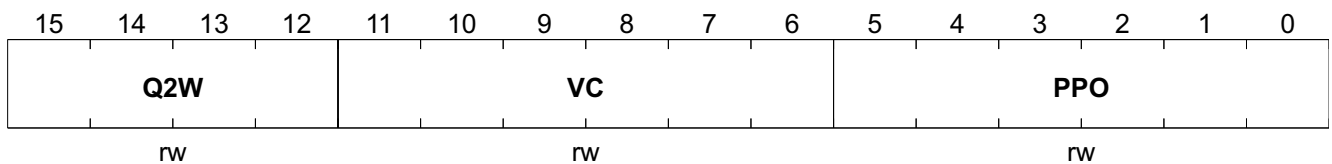

Field	Bits	Type	Description
Q2W	15:12	rw	Queue 2 Weight See Chapter 3.1.15 Priority Queue for more detail information.
VC	11:6	rw	VID Check It is a per port function. 0 _B , Doesn't check 1 _B , checks
PPO	5:0	rw	PPPOE Port Only It's a per port function 0 _B , The port is not a PPPOE Only port 1 _B , The port is a PPPOE Only port

Queue 3 Weight, Back to Port VLAN, and Admit Only VLAN-Tagged

Q3WBPVAO	Offset	Reset Value
Queue 3 Weight, Back to Port VLAN, and Admit Only VLAN-Tagged	27 _H	1000 _H

Registers Description

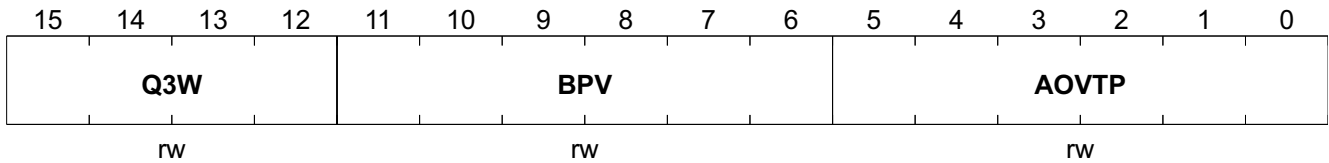

Field	Bits	Type	Description
Q3W	15:12	rw	Queue 3 Weight See Chapter 3.1.15 Priority Queue for more detail information.
BPV	11:6	rw	Back To Port VLAN It is a per port function 0 _B , Doesn't back to Port VLAN 1 _B , Backs to Port VLAN
AOVTP	5:0	rw	Admit Only VLAN_Tagged Packet It is a per port function 0 _B , The port doesn't check if the packets are VLAN-Tagged 1 _B , The port drops the packets that carry no VID. (That is Untagged Packets or Priority-Tagged Packets)

Input Double Tag Enable, and P0VID[11:4]

IDTEP	Offset	Reset Value
Input Double Tag Enable, and P0VID[11:4]	28 _H	0000 _H

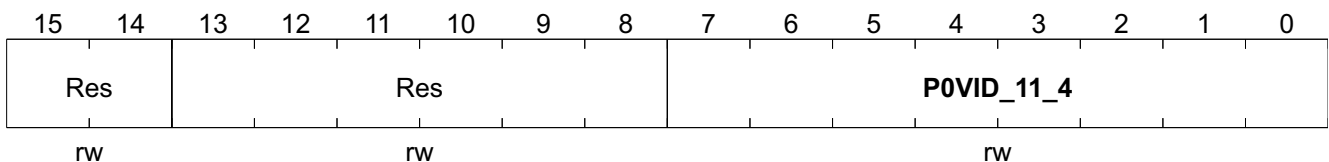

Field	Bits	Type	Description
Res	15:14	rw	Reserved
Res	13:8	rw	Reserved
P0VID_11_4	7:0	rw	P0VID[11:4] VID bit 11 ~ 4 fo Port 0

Output Double Tag Enable, and P1VID[11:4]

ODTEP	Offset	Reset Value
Output Double Tag Enable, and P1VID[11:4]	29 _H	0000 _H

Registers Description

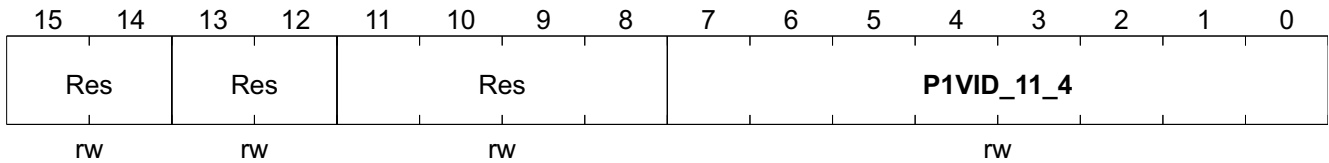

Field	Bits	Type	Description
Res	15:14	rw	Reserved
Res	13:12	rw	Reserved
Res	11:8	rw	Reserved
P1VID_11_4	7:0	rw	P1VID[11:4] VID bit 11 ~ 4 of Port 1.

Output Tag Bypass, and P2VID[11:4]

OTBP **Offset** **Reset Value**
Output Tag Bypass, and P2VID[11:4] **2A_H** **3F00_H**

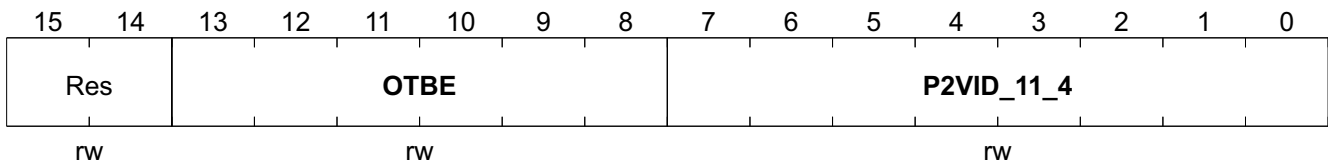

Field	Bits	Type	Description
Res	15:14	rw	Reserved
OTBE	13:8	rw	Output Tag Bypass Enable It's a per port function. See Chapter 3.1.14.12 Egress Tag Rule for more detailed information.
P2VID_11_4	7:0	rw	P2VID[11:4] VID bit 11 ~ 4 of Port 2.

P3VID[11:4], and P4VID[11:4]

P11_4 **Offset** **Reset Value**
P3VID[11:4], and P4VID[11:4] **2B_H** **0000_H**

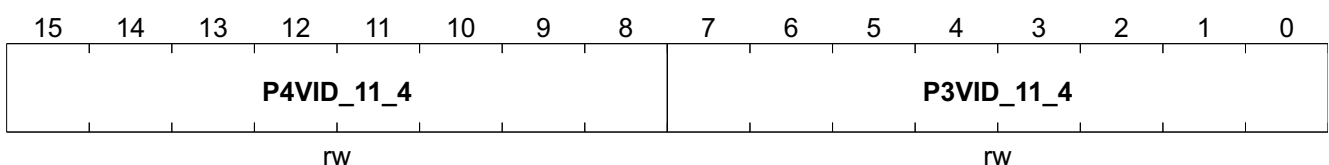

Field	Bits	Type	Description
P4VID_11_4	15:8	rw	P4VID[11:4] VID bit 11 ~ 4 of Port 4.
P3VID_11_4	7:0	rw	P3VID[11:4] VID bit 11 ~ 4 of Port 3.

Reserved Address Control, and P5VID[11:4]

RACP **Offset**
Reserved Address Control, and P5VID[11:4] **2C_H** **Reset Value**
D000_H

15	14	13	12	11	10	9	8	7	6	5	4	3	2	1	0
AMA3	AMA2	AMA1	AMA0	TAG_SHIFT				P5VID_11_4							
rw	rw	rw	rw	rw				rw							

Field	Bits	Type	Description
AMA3	15	rw	Action of MAC Address 3 The Action of MAC Address = 0180C2000010 _H ~ 0180C20000FF _H
AMA2	14	rw	Action of MAC Address 2 The Action of MAC Address = 0180C2000002 _H ~ 0180C200000F _H
AMA1	13	rw	Action of MAC Address 1 The Action of MAC Address = 0180C2000001 _H
AMA0	12	rw	Action of MAC Address 0 The Action of MAC Address = 0180C2000000 _H
TAG_SHIFT	11:8	rw	Tag Shift
P5VID_11_4	7:0	rw	P5VID[11:4] VID bit 11 ~ 4 of Port 5

PHY Control Register

PHYC **Offset**
PHY Control Register **2D_H** **Reset Value**
4442_H

15	14	13	12	11	10	9	8	7	6	5	4	3	2	1	0
CICD	Res	Res	Res	Res	Res	Res	Res	Res	Res	Res	Res	Res	Res	Res	Res
rw	rw	rw	rw	rw	rw	rw	rw	rw	rw	rw	rw	rw	rw	rw	rw

Field	Bits	Type	Description
CICD	15	rw	Chip ID Check Disable 0 _B , Checks CHIP ID in 32 bit SDC/SDO 1 _B , Doesn't check CHIP ID in 32 bit SDC/SDIO
Res	14	rw	Reserved
Res	13	rw	Reserved
Res	12:11	rw	Reserved
Res	10	rw	Reserved
Res	9	rw	Reserved
Res	8	rw	Reserved
Res	7	rw	Reserved
Res	6	rw	Reserved
Res	5	rw	Reserved
Res	4	rw	Reserved
Res	3:2	rw	Reserved
Res	1:0	rw	Reserved

ADM TAG Ether Type

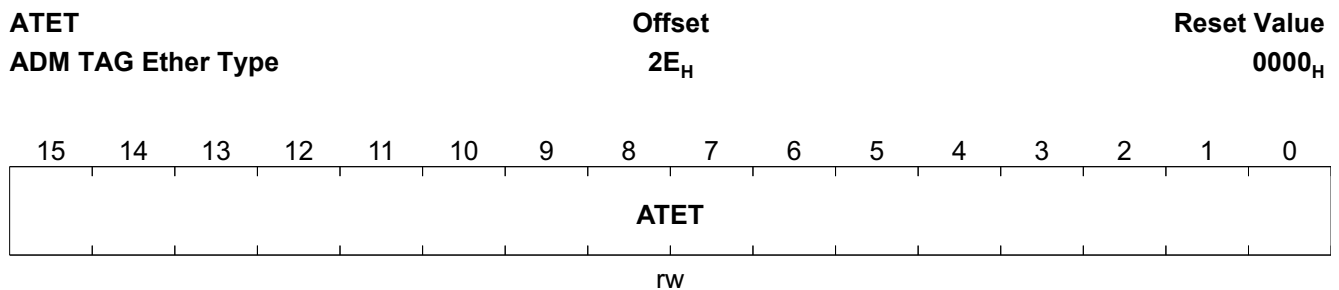

Field	Bits	Type	Description
ATET	15:0	rw	ADM TAG Ether Type This value is used by the user to define their Ether-Type. When Special Tag Receive is enabled, Samurai-6M/6MX (ADM6996M/MX) checks the packets on the CPU port to see if the two bytes following the SA are the same as ADM TAG Ether Type . If they are different, Samurai-6M/6MX (ADM6996M/MX) bypasses the Special Tag. If the same, Samurai-6M/6MX (ADM6996M/MX) will use the value in the Special Tag to do switching decisions .

PHY Restart Register



Registers Description

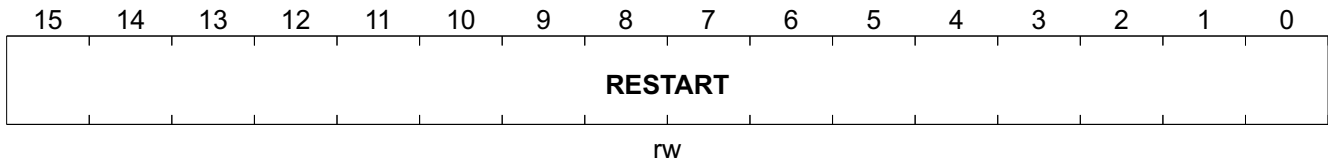

Field	Bits	Type	Description
RESTART	15:0	rw	Restart Samurai-6M/6MX (ADM6996M/MX) writes this register to restart all the PHYs in the switch. The value written is not important.

Miscellaneous Register

MISC **Offset**
Miscellaneous Register **30_H** **Reset Value**
0987_H

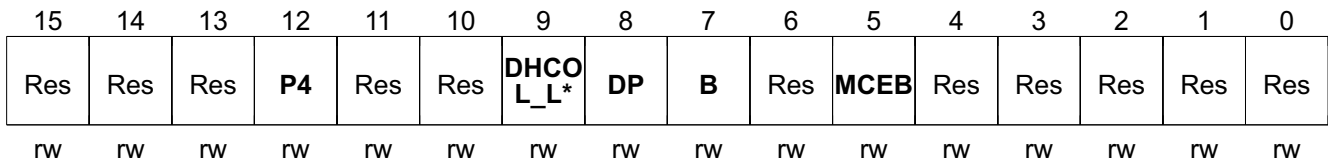

Field	Bits	Type	Description
Res	15	rw	Reserved
Res	14	rw	Reserved
Res	13	rw	Reserved
P4	12	rw	Port 4 LED Mode 0 _B , LinkAct/DupCol/Speed. 1 _B , Link/Act/Speed.
Res	11	rw	Reserved
Res	10	rw	Reserved
DHCOL_LED_EN	9	rw	Dual Speed Hub COL_LED Enable 0 _B , Normal LED display. 1 _B , Dual Speed Hub LED display. Port0 Col LED: 10M Col LED. Port1 Col LED: 100M Col LED.
DP	8	rw	Drop Packets Drop packets when the link partner does not follow the PAUSE protocol. 0 _B , Disable. 1 _B , Enable to drop packets.
B	7	rw	BYPASS Bypass Tag/Untag function. 0 _B , Disable. 1 _B , Enable to bypass Tag/Untag function
Res	6	rw	Reserved

Registers Description

Field	Bits	Type	Description
MCEB	5	rw	MAC Clone Enable Bits Select 0 _B , Select 1 bit MAC Clone function. 1 _B , Select 2 bits MAC Clone function.
Res	4	rw	Reserved
Res	3	rw	Reserved
Res	2	rw	Reserved
Res	1	rw	Reserved
Res	0	rw	Reserved

Basic Bandwidth Control Register 0

BBC0 **Offset**
Basic Bandwidth Control Register 0 **31_H** **Reset Value**
0000_H

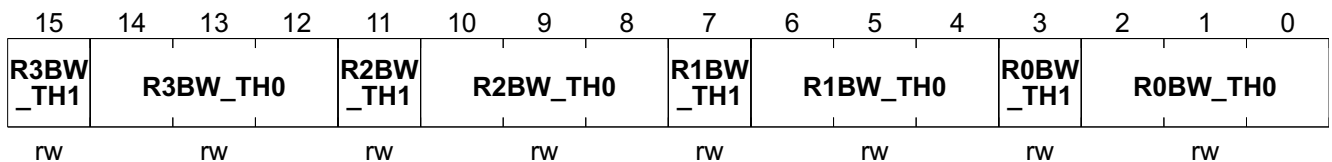

Field	Bits	Type	Description
R3BW_TH1	15	rw	Port 3 Receive Bandwidth Maximum[3]. See register 0033 _H , P3RBCE for more details.
R3BW_TH0	14:12	rw	Port 3 Receive Bandwidth Configuration See register 0033 _H , P3RBCE for more details.
R2BW_TH1	11	rw	Port 2 Receive Bandwidth Maximum[3]. See register 0033 _H , P2RBCE for more details.
R2BW_TH0	10:8	rw	Port 2 Receive Bandwidth Configuration See register 0033 _H , P2RBCE for more details.
R1BW_TH1	7	rw	Port 1 Receive Bandwidth Maximum[3]. See register 0033 _H , P1RBCE for more details.
R1BW_TH0	6:4	rw	Port 1 Receive Bandwidth Configuration See register 0033 _H , P1RBCE for more details.
R0BW_TH1	3	rw	Port 0 Receive Bandwidth Maximum[3]. See register 0033 _H , P0RBCE for more details.
R0BW_TH0	2:0	rw	Port 0 Receive Bandwidth Configuration See register 0033 _H , P0RBCE for more details.

Basic Bandwidth Control Register 1

BBC1 **Offset**
Basic Bandwidth Control Register 1 **32_H** **Reset Value**
0000_H

Registers Description

15	14	13	12	11	10	9	8	7	6	5	4	3	2	1	0
T1BW_TH1	T1BW_TH0			T0BW_TH1	T0BW_TH0			R5BW_TH1	R5BW_TH0			R4BW_TH1	R4BW_TH0		
rw	rw			rw	rw			rw	rw			rw	rw		

Field	Bits	Type	Description
T1BW_TH1	15	rw	Port 1 Transmit Bandwidth Maximum[3]. See register 0033 _H , P1TBCE for more details.
T1BW_TH0	14:12	rw	Port 1 Transmit Bandwidth Maximum[2:0]. See register 0033 _H , P1TBCE for more details.
T0BW_TH1	11	rw	Port 0 Transmit Bandwidth Maximum[3]. See register 0033 _H , P0TBCE for more details.
T0BW_TH0	10:8	rw	Port 0 Transmit Bandwidth Maximum[2:0]. See register 0033 _H , P0TBCE for more details.
R5BW_TH1	7	rw	Port 5 Receive Bandwidth Maximum[3]. See register 0033 _H , P5RBCE for more details.
R5BW_TH0	6:4	rw	Port 5 Receive Bandwidth Configuration See register 0033 _H , P5RBCE for more details.
R4BW_TH1	3	rw	Port 4 Receive Bandwidth Maximum[3]. See register 0033 _H , P4RBCE for more details.
R4BW_TH0	2:0	rw	Port 4 Receive Bandwidth Configuration See register 0033 _H , P4RBCE for more details.

Bandwidth Control Enable Register

BCE	Offset	Reset Value
Bandwidth Control Enable Register	33_H	0000_H

15	14	13	12	11	10	9	8	7	6	5	4	3	2	1	0
IPCP	CLC	Res	ANBCE	P5TBCE	P4TBCE	P3TBCE	P5RBCE	P4RBCE	P3RBCE	P2TBCE	P2RBCE	P1TBCE	P1RBCE	P0TBCE	P0RBCE
rw	rw	rw	rw	rw	rw	rw	rw	rw	rw	rw	rw	rw	rw	rw	rw

Field	Bits	Type	Description
IPCP	15	rw	Invert P4 Clock in PCS 0 _D , Disable 1 _D , Enable
CLC	14	rw	Check the Length of CRS 0 _D , Enable 1 _D , Disable
Res	13	rw	Reserved

Registers Description

Field	Bits	Type	Description
ANBCE	12	rw	Samurai-6M/6MX (ADM6996M/MX) New Bandwidth Control Enable 0 _B , Disable 1 _B , Enable
P5TBCE	11	rw	Port 5 Transmit Bandwidth Control Enable The transmitted bandwidth is { T5BW_TH3 , T5BW_TH2 , T5BW_TH1 , T5BW_TH0 , 000000 _B } kbit/s. K = 1000. 0 _B , Disable 1 _B , Enable
P4TBCE	10	rw	Port 4 Transmit Bandwidth Control Enable The transmitted bandwidth is { T4BW_TH3 , T4BW_TH2 , T4BW_TH1 , T4BW_TH0 , 000000 _B } kbit/s. K = 1000. 0 _B , Disable 1 _B , Enable
P3TBCE	9	rw	Port 3 Transmit Bandwidth Control Enable The transmitted bandwidth is { T3BW_TH3 , T3BW_TH2 , T3BW_TH1 , T3BW_TH0 , 000000 _B } kbit/s. K = 1000. 0 _B , Disable 1 _B , Enable
P5RBCE	8	rw	Port 5 Receive Bandwidth Control Enable The received bandwidth is { R5BW_TH3 , R5BW_TH2 , R5BW_TH1 , R5BW_TH0 , 000000 _B } kbit/s. K = 1000. 0 _B , Disable 1 _B , Enable
P4RBCE	7	rw	Port 4 Receive Bandwidth Control Enable The received bandwidth is { R4BW_TH3 , R4BW_TH2 , R4BW_TH1 , R4BW_TH0 , 000000 _B } kbit/s. K = 1000. 0 _B , Disable 1 _B , Enable
P3RBCE	6	rw	Port 3 Receive Bandwidth Control Enable The received bandwidth is { R3BW_TH3 , R3BW_TH2 , R3BW_TH1 , R3BW_TH0 , 000000 _B } kbit/s. K = 1000. 0 _B , Disable 1 _B , Enable
P2TBCE	5	rw	Port 2 Transmit Bandwidth Control Enable The transmitted bandwidth is { T2BW_TH3 , T2BW_TH2 , T2BW_TH1 , T2BW_TH0 , 000000 _B } kbit/s. K = 1000. 0 _B , Disable 1 _B , Enable
P2RBCE	4	rw	Port 2 Receive Bandwidth Control Enable The received bandwidth is { R2BW_TH3 , R2BW_TH2 , R2BW_TH1 , R2BW_TH0 , 000000 _B } kbit/s. K = 1000. 0 _B , Disable 1 _B , Enable
P1TBCE	3	rw	Port 1 Transmit Bandwidth Control Enable The transmitted bandwidth is { T1BW_TH3 , T1BW_TH2 , T1BW_TH1 , T1BW_TH0 , 000000 _B } kbit/s. K = 1000. 0 _B , Disable 1 _B , Enable

Field	Bits	Type	Description
P1RBCE	2	rw	Port 1 Receive Bandwidth Control Enable The received bandwidth is { R1BW_TH3 , R1BW_TH2 , R1BW_TH1 , R1BW_TH0 , 000000 _B } kbit/s. K = 1000. 0 _B , Disable 1 _B , Enable
P0TBCE	1	rw	Port 0 Transmit Bandwidth Control Enable The transmitted bandwidth is { T0BW_TH3 , T0BW_TH2 , T0BW_TH1 , T0BW_TH0 , 000000 _B } kbit/s. K = 1000. 0 _B , Disable 1 _B , Enable
P0RBCE	0	rw	Port 0 Receive Bandwidth Control Enable The received bandwidth is { R0BW_TH3 , R0BW_TH2 , R0BW_TH1 , R0BW_TH0 , 000000 _B } kbit/s. K = 1000. 0 _B , Disable 1 _B , Enable

Extended Bandwidth Control Register 0

EBC0	Offset	Reset Value
Extended Bandwidth Control Register 0	34_H	0000_H

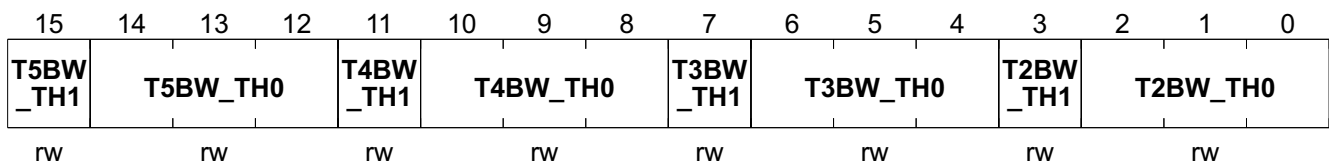

Field	Bits	Type	Description
T5BW_TH1	15	rw	Port 5 Transmit Bandwidth Maximum[3]. See register 0033 _H , P5TBCE for more details.
T5BW_TH0	14:12	rw	Port 5 Transmit Bandwidth Maximum[2:0]. See register 0033 _H , P5TBCE for more details.
T4BW_TH1	11	rw	Port 4 Transmit Bandwidth Maximum[3]. See register 0033 _H , P4TBCE for more details.
T4BW_TH0	10:8	rw	Port 4 Transmit Bandwidth Maximum[2:0]. See register 0033 _H , P4TBCE for more details.
T3BW_TH1	7	rw	Port 3 Transmit Bandwidth Maximum[3]. See register 0033 _H , P3TBCE for more details.
T3BW_TH0	6:4	rw	Port 3 Transmit Bandwidth Maximum[2:0]. See register 0033 _H , P3TBCE for more details.
T2BW_TH1	3	rw	Port 2 Transmit Bandwidth Maximum[3]. See register 0033 _H , P2TBCE for more details.
T2BW_TH0	2:0	rw	Port 2 Transmit Bandwidth Maximum[2:0]. See register 0033 _H , P2TBCE for more details.

Extended Bandwidth Control Register 1

EBC1 **Offset**
Extended Bandwidth Control Register 1 **35_H** **Reset Value**
0000_H

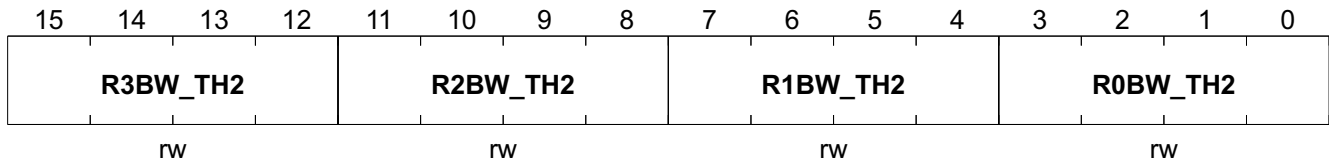

Field	Bits	Type	Description
R3BW_TH2	15:12	rw	Port 3 Receive Bandwidth Maximum[7:4]. See register 0033 _H , P3RBCE for more details.
R2BW_TH2	11:8	rw	Port 2 Receive Bandwidth Maximum[7:4]. See register 0033 _H , P2RBCE for more details.
R1BW_TH2	7:4	rw	Port 1 Receive Bandwidth Maximum[7:4]. See register 0033 _H , P1RBCE for more details.
R0BW_TH2	3:0	rw	Port 0 Receive Bandwidth Maximum[7:4]. See register 0033 _H , P0RBCE for more details.

Extended Bandwidth Control Register 2

EBC2 **Offset**
Extended Bandwidth Control Register 2 **36_H** **Reset Value**
0000_H

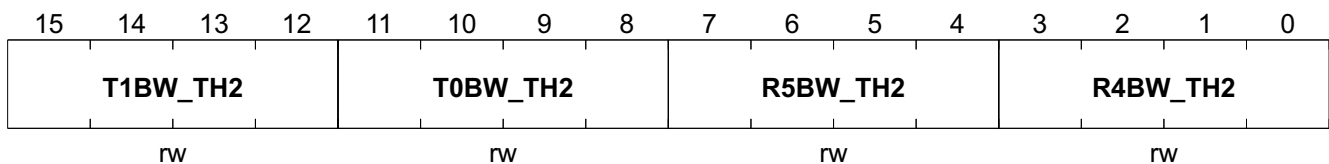

Field	Bits	Type	Description
T1BW_TH2	15:12	rw	Port 1 Transmit Bandwidth Maximum[7:4] See register 0033 _H , P1TBCE for more details.
T0BW_TH2	11:8	rw	Port 0 Transmit Bandwidth Maximum[7:4]. See register 0033 _H , P0TBCE for more details.
R5BW_TH2	7:4	rw	Port 5 Receive Bandwidth Maximum[7:4]. See register 0033 _H , P5RBCE for more details.
R4BW_TH2	3:0	rw	Port 4 Receive Bandwidth Maximum[7:4]. See register 0033 _H , P4RBCE for more details.

Extended Bandwidth Control Register 3

EBC3 **Offset**
Extended Bandwidth Control Register 3 **37_H** **Reset Value**
0000_H

15	14	13	12	11	10	9	8	7	6	5	4	3	2	1	0
T5BW_TH2				T4BW_TH2				T3BW_TH2				T2BW_TH2			
rw				rw				rw				rw			

Field	Bits	Type	Description
T5BW_TH2	15:12	rw	Port 5 Transmit Bandwidth Maximum[7:4]. See register 0033 _H , P5TBCE for more details.
T4BW_TH2	11:8	rw	Port 4 Transmit Bandwidth Maximum[7:4]. See register 0033 _H , P4TBCE for more details.
T3BW_TH2	7:4	rw	Port 3 Transmit Bandwidth Maximum[7:4]. See register 0033 _H , P3TBCE for more details.
T2BW_TH2	3:0	rw	Port 2 Transmit Bandwidth Maximum[7:4]. See register 0033 _H , P2TBCE for more details.

Extended Bandwidth Control Register 4

EBC4 **Offset**
Extended Bandwidth Control Register 4 **38_H** **Reset Value**
0000_H

15	14	13	12	11	10	9	8	7	6	5	4	3	2	1	0	
FMDIX0	R4BW_TH3				R3BW_TH3			R2BW_TH3			R1BW_TH3			R0BW_TH3		
rw	rw				rw			rw			rw			rw		

Field	Bits	Type	Description
FMDIX0	15	rw	Port 0 MDIX Control This bit can be used for Port 0 MDI/MDIX selection. It is useful when Port 0 Crossover Auto Detect is disabled and 16 bits management interface (SDC/SDIO) is used. 0 _B , Using MDI 1 _B , Using MDIX
R4BW_TH3	14:12	rw	Port 4 Receive Bandwidth Maximum[10:8]. See register 0033 _H , P4RBCE for more details.
R3BW_TH3	11:9	rw	Port 3 Receive Bandwidth Maximum[10:8]. See register 0033 _H , P3RBCE for more details.

Registers Description

Field	Bits	Type	Description
R2BW_TH3	8:6	rw	Port 2 Receive Bandwidth Maximum[10:8] . See register 0033 _H , P2RBCE for more details.
R1BW_TH3	5:3	rw	Port 1 Receive Bandwidth Maximum[10:8] . See register 0033 _H , P1RBCE for more details.
R0BW_TH3	2:0	rw	Port 0 Receive Bandwidth Maximum[10:8] . See register 0033 _H , P0RBCE for more details.

Extended Bandwidth Control Register 5

EBC5	Offset	Reset Value
Extended Bandwidth Control Register 5	39_H	0000_H

15	14	13	12	11	10	9	8	7	6	5	4	3	2	1	0
FMDIX1	T3BW_TH3			T2BW_TH3			T1BW_TH3			T0BW_TH3			R5BW_TH3		
r	rw			rw			rw			rw			rw		

Field	Bits	Type	Description
FMDIX1	15	r	Port 1 MDIX Control This bit can be used for Port 1 MDI/MDIX selection. It is useful when Port 1 Crossover Auto Detect is disabled and 16 bits management interface (SDC/SDIO) is used. 0 _B , Using MDI 1 _B , Using MDIX
T3BW_TH3	14:12	rw	Port 3 Transmit Bandwidth Maximum[10:8] . See register 0033 _H , P3TBCE for more details.
T2BW_TH3	11:9	rw	Port 2 Transmit Bandwidth Maximum[10:8] . See register 0033 _H , P2TBCE for more details.
T1BW_TH3	8:6	rw	Port 1 Transmit Bandwidth Maximum[10:8] . See register 0033 _H , P1TBCE for more details.
T0BW_TH3	5:3	rw	Port 0 Transmit Bandwidth Maximum[10:8] . See register 0033 _H , P0TBCE for more details.
R5BW_TH3	2:0	rw	Port 5 Receive Bandwidth Maximum[10:8] . See register 0033 _H , P5RBCE for more details.

Default VLAN Member and Extended Bandwidth Control Register 6

DVMEBC6	Offset	Reset Value
Default VLAN Member and Extended Bandwidth Control Register 6	3A_H	0FC0_H

Registers Description

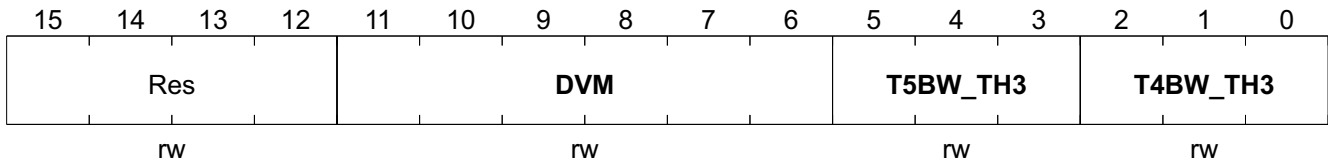

Field	Bits	Type	Description
Res	15:12	rw	Reserved
DVM	11:6	rw	Default VLAN Member
T5BW_TH3	5:3	rw	Port 5 Transmit Bandwidth Maximum[10:8]. See register 0033 _H , P5TBCE for more details.
T4BW_TH3	2:0	rw	Port 4 Transmit Bandwidth Maximum[10:8]. See register 0033 _H , P4TBCE for more details.

New Storm Register 0

NS0	Offset	Reset Value
New Storm Register 0	3B_H	0000_H

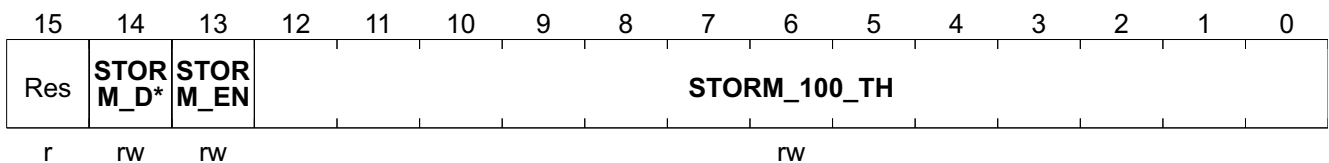

Field	Bits	Type	Description
Res	15	r	Reserved
STORM_DRO P_EN	14	rw	Storm Drop Enable 0 _B , Doesn't drop in the storming period 1 _B , Drops in the storming period
STORM_EN	13	rw	Storm Enable 0 _B , Disable Samurai-6M/6MX (ADM6996M/MX) style broadcast storm protection 1 _B , Enable Samurai-6M/6MX (ADM6996M/MX) style broadcast storm protection
STORM_100_TH	12:0	rw	100M Threshold See Chapter 3.1.9 Broadcast Storm for more detailed information. It is used when all ports link up in the 100M. The upper bound is reached when the number of the packets received during the 50 ms is over 100M Threshold.

New Storm Register 1

NS1 **Offset**
New Storm Register 1 **3C_H** **Reset Value**
0000_H

15	14	13	12	11	10	9	8	7	6	5	4	3	2	1	0
FMDI X4	FMDI X3	FMDI X2	STORM_10_TH												
rw	rw	rw	rw												

Field	Bits	Type	Description
FMDIX4	15	rw	Port 4 MDIX Control This bit can be used for Port 4 MDI/MDIX selection. It is useful when Port 4 Crossover Auto Detect is disabled and 16 bits management interface (SDC/SDIO) is used. 0 _B , Using MDI 1 _B , Using MDIX
FMDIX3	14	rw	Port 3 MDIX Control This bit can be used for Port 3 MDI/MDIX selection. It is useful when Port 3 Crossover Auto Detect is disabled and 16 bits management interface (SDC/SDIO) is used. 0 _B , Using MDI 1 _B , Using MDIX
FMDIX2	13	rw	Port 2 MDIX Control This bit can be used for Port 2 MDI/MDIX selection. It is useful when Port 2 Crossover Auto Detect is disabled and 16 bits management interface (SDC/SDIO) is used. 0 _B , Using MDI 1 _B , Using MDIX
STORM_10_TH	12:0	rw	10M Threshold See Chapter 3.1.9 Broadcast Storm for more detailed information. It is used when one of ports link up in the 10M. The upper bound is reached when the number of the packets received during the 50 ms is over 10M Threshold.

New Reserve Address Control Register 0

NRAC0 **Offset**
New Reserve Address Control Register 0 **3D_H** **Reset Value**
00FD_H

15	14	13	12	11	10	9	8	7	6	5	4	3	2	1	0
NRTB	PG	PRI_S	PRI_B	R3PP	R2PP	GPP	R1PP	R0PP	PPP	SPP	BPP				
rw	rw	rw	rw	rw	rw	rw	rw	rw	rw	rw	rw	rw	rw	rw	rw

Field	Bits	Type	Description
NRTB	15:14	rw	New Reserve TXTAG for BPDU 00 _B , System Default Tag 01 _B , Unmodified 10 _B , Always Tagged 11 _B , Always Untagged
PG	13:12	rw	PRI for GXP 00 _B , Queue 0 01 _B , Queue 1 10 _B , Queue 2 11 _B , Queue 3
PRI_S	11:10	rw	PRI for SLOW/PAE/RESER_R0/RESER_R1/RESER_R2/RESER_R3 00 _B , Queue 0 01 _B , Queue 1 10 _B , Queue 2 11 _B , Queue 3
PRI_B	9:8	rw	PRI for BPDU 00 _B , Queue 0 01 _B , Queue 1 10 _B , Queue 2 11 _B , Queue 3
R3PP	7	rw	RESER_R3 Pass Portmap 0 _B , RESER_R3 Pass Portmap is 000000 _B 1 _B , RESER_R3 Pass Portmap is 111111 _B
R2PP	6	rw	RESER_R2 Pass Portmap 0 _B , RESER_R2 Pass Portmap is 000000 _B 1 _B , RESER_R2 Pass Portmap is 111111 _B
GPP	5	rw	GXP Pass Portmap 0 _B , GXP Pass Portmap is 000000 _B 1 _B , GXP Pass Portmap is 111111 _B
R1PP	4	rw	RESER_R1 Pass Portmap 0 _B , RESER_R1 Pass Portmap is 000000 _B 1 _B , RESER_R1 Pass Portmap is 111111 _B
R0PP	3	rw	RESER_R0 Pass Portmap 0 _B , RESER_R0 Pass Portmap is 000000 _B 1 _B , RESER_R0 Pass Portmap is 111111 _B
PPP	2	rw	PAE Pass Portmap 0 _B , PAE Pass Portmap is 000000 _B 1 _B , PAE Pass Portmap is 111111 _B
SPP	1	rw	Slow Pass Portmap 0 _B , SLOW Pass Portmap is 000000 _B 1 _B , SLOW Pass Portmap is 111111 _B
BPP	0	rw	BPDU Pass Portmap 0 _B , BPDU Pass Portmap is 000000 _B 1 _B , BPDU Pass Portmap is 111111 _B

New Reserve Address Control Register 1

NRAC1 **Offset**
New Reserve Address Control Register 1 **3E_H** **Reset Value**
0000_H

	15	14	13	12	11	10	9	8	7	6	5	4	3	2	1	0
	MCA1	MCA2	NRMG	NRMS	MRMB	NRSG	NRSS	NRSB	NRCG	NRCS	NRCB	NRTG	NRTS			
	rw	rw	rw	rw	rw	rw	rw	rw	rw	rw	rw	rw	rw	rw	rw	rw

Field	Bits	Type	Description
MCA1	15	rw	Mac Control Action 1 Mac Control Action when OPCODE is 01 _H 0 _B , The same as Mac Control Action when OPCODE is not 01 _H 1 _B , Discards
MCA2	14:13	rw	Mac Control Action 2 Mac Control Action when OPCODE is not 01 _H 00 _B , Defaults Output Ports 01 _B , Discards 10 _B , If the receiving port is the CPU port, forward it to the default output ports. If the receiving port is not the CPU port, forward it to the CPU port 11 _B , Forwards to the default output ports except the CPU port
NRMG	12	rw	New Reserve Management for GXP 0 _B , Doesn't identify as management packets 1 _B , Identifies as management packets
NRMS	11	rw	New Reserve Management for SLOW/PAE/RESER_R0/RESER_R1/RESER_R2/RESER_R3 0 _B , Doesn't identify as management packets 1 _B , Identifies as management packets
MRMB	10	rw	New Reserve Management for BPDU 0 _B , Doesn't identify as management packets 1 _B , Identifies as management packets
NRSG	9	rw	New Reserve Span for GXP 0 _B , Doesn't identify as management packets 1 _B , Identifies as management packets
NRSS	8	rw	New Reserve Span for SLOW/PAE/RESER_R0/RESER_R1/RESER_R2/RESER_R3 0 _B , Doesn't identify as span packets 1 _B , Identifies as span packets
NRSB	7	rw	New Reserve SPAN for BPDU 0 _B , Doesn't identify as span packets 1 _B , Identifies as span packets
NRCG	6	rw	New Reserve Cross_VLAN for GXP 0 _B , Follows VLAN 1 _B , Crosses VLAN

Registers Description

Field	Bits	Type	Description
NRCS	5	rw	New Reserve Cross_VLAN. for SLOW/PAE/RESER_R0/RESER_R1/RESER_R2/RESER_R3 0 _B , Follows VLAN 1 _B , Crosses VLAN
NRCB	4	rw	New Reserve Cross_VLAN for BPDU 0 _B , Follows VLAN 1 _B , Crosses VLAN
NRTG	3:2	rw	New Reserve TXTAG for GXP 00 _B , System Default Tag 01 _B , Unmodified 10 _B , Always Tagged 11 _B , Always Untagged
NRTS	1:0	rw	New Reserve TXTAG for SLOW/PAE/RESER_R0/RESER_R1/RESER_R2/RESER_R3 00 _B , System Default Tag 01 _B , Unmodified 10 _B , Always Tagged 11 _B , Always Untagged

Hardware IGMP Control Register

HIC **Offset**
Hardware IGMP Control Register **3F_H** **Reset Value**
7C80_H

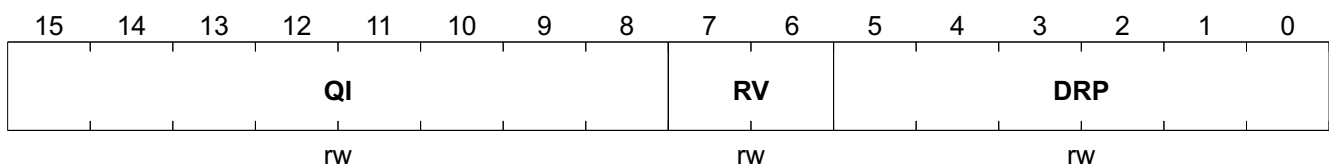

Field	Bits	Type	Description
QI	15:8	rw	Query Interval The register is used to define Query_Interval when hardware based IGMP snooping function is enabled (000C _H , HISE). The automatically learned router port will be aged out if no IGMP Query frame received from the router port for (Query_Interval * Robust Variable) seconds.
RV	7:6	rw	Robust Variable The register is used to define Robust_Variable when hardware based IGMP snooping function is enabled (000C _H , HISE). 00 _B , Reserved 01 _B , 1 time 10 _B , 2 times 11 _B , 3 times

Field	Bits	Type	Description
DRP	5:0	rw	Default Router Portmap The register is used to define Static Router Port when hardware based IGMP snooping function and default router port function are enabled (000C _H , HISE & HIDRE).

4.2 EEPROM Extended Registers

VLAN Filter 0 Low

VF0L VLAN Filter 0 Low	Offset 40 _H	Reset Value 003F _H
----------------------------------	----------------------------------	---

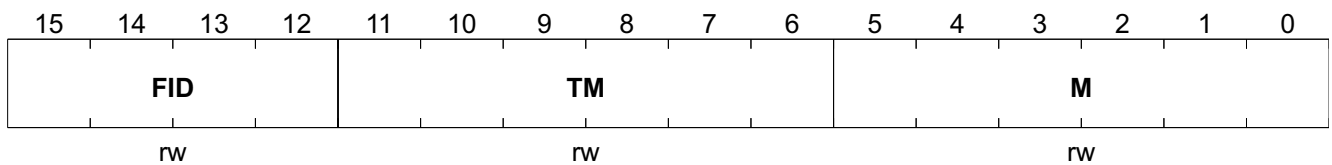

Field	Bits	Type	Description
FID	15:12	rw	FID The forwarding or learning group that the VID is assigned.
TM	11:6	rw	Tagged Member These bits indicate which ports are associated with the VID should transmit tagged packets. Tagged Member[x] Description. 0 _B , Port x should transmit untagged packets 1 _B , Port x should transmit tagged packets
M	5:0	rw	Member These bits indicate which ports are the members of the VLAN. Member[x] Description. 0 _B , Port x is not a VLAN member 1 _B , Port x is a VLAN member

Similar Registers

Table 57 VFxL Registers

Register Short Name	Register Long Name	Offset Address	Page Number
VF1L	VLAN Filter 1 Low	42 _H	
VF2L	VLAN Filter 2 Low	44 _H	
VF3L	VLAN Filter 3Low	46 _H	
VF4L	VLAN Filter 4 Low	48 _H	
VF5L	VLAN Filter 5 Low	4A _H	
VF6L	VLAN Filter 6 Low	4C _H	
VF7L	VLAN Filter 7 Low	4E _H	

Table 57 VFL Registers (cont'd)

Register Short Name	Register Long Name	Offset Address	Page Number
VF8L	VLAN Filter 8 Low	50 _H	
VF9L	VLAN Filter 9 Low	52 _H	
VF10L	VLAN Filter 10 Low	54 _H	
VF11L	VLAN Filter 11 Low	56 _H	
VF12L	VLAN Filter 12 Low	58 _H	
VF13L	VLAN Filter 13 Low	5A _H	
VF14L	VLAN Filter 14 Low	5C _H	
VF15L	VLAN Filter 15 Low	5E _H	

VLAN Filter 0 High

VF0H **Offset** **Reset Value**
VLAN Filter 0 High **41_H** **8001_H**

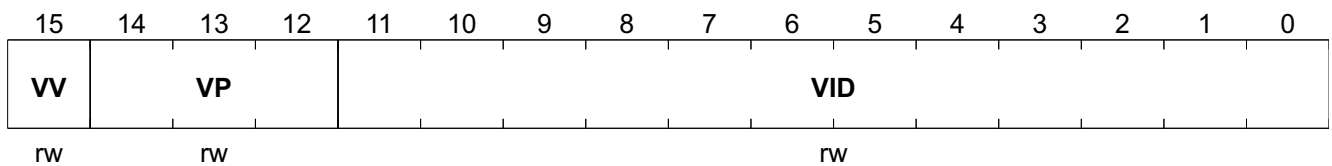

Field	Bits	Type	Description
VV	15	rw	VLAN_Valid 0 _B , VLAN filter is not valid 1 _B , VLAN Filter is valid
VP	14:12	rw	VLAN PRI It indicates the VLAN priority that is associated with VID.
VID	11:0	rw	VID It indicates the VLAN ID that is associated with FID, Tagged Member, Member and VLAN PRI.

Similar Registers

All VFxH registers have the same structure and characteristics, see [VF0H](#).
 The offset addresses of the other VFxH registers are listed in [Table 58](#).

Table 58 VFxH Registers

Register Short Name	Register Long Name	Offset Address	Page Number
VF1H	VLAN Filter 1 High	43 _H	
VF2H	VLAN Filter 2 High	45 _H	
VF3H	VLAN Filter 3 High	47 _H	
VF4H	VLAN Filter 4 High	49 _H	
VF5H	VLAN Filter 5 High	4B _H	
VF6H	VLAN Filter 6 High	4D _H	

Table 58 VFxH Registers (cont'd)

Register Short Name	Register Long Name	Offset Address	Page Number
VF7H	VLAN Filter 7 High	4F _H	
VF8H	VLAN Filter 8 High	51 _H	
VF9H	VLAN Filter 9 High	53 _H	
VF10H	VLAN Filter 10 High	55 _H	
VF11H	VLAN Filter 11 High	57 _H	
VF12H	VLAN Filter 12 High	59 _H	
VF13H	VLAN Filter 13 High	5B _H	
VF14H	VLAN Filter 14 High	5D _H	
VF15H	VLAN Filter 15 High	5F _H	

Type Filter 0

TF0	Offset	Reset Value
Type Filter 0	60_H	0000_H

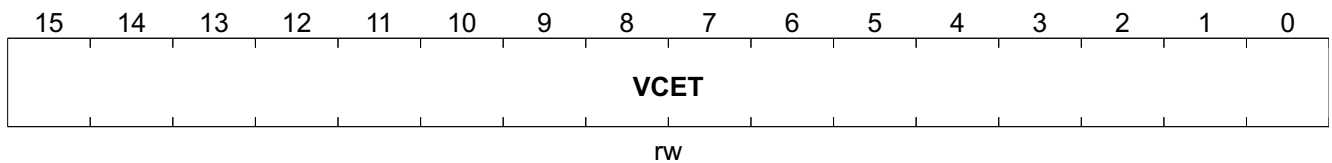

Field	Bits	Type	Description
VCET	15:0	rw	Value Compared with Ether-Type

Similar Registers

All TFx registers have the same structure and characteristics, see [TF0](#).
The offset addresses of the other TFx registers are listed in [Table 59](#).

Table 59 TFx Registers

Register Short Name	Register Long Name	Offset Address	Page Number
TF1	Type Filter 1	61 _H	
TF2	Type Filter 2	62 _H	
TF3	Type Filter 3	63 _H	
TF4	Type Filter 4	64 _H	
TF5	Type Filter 5	65 _H	
TF6	Type Filter 6	66 _H	
TF7	Type Filter 7	67 _H	

Protocol Filter 1 and 0

PF_1_0 **Offset**
Protocol Filter 1 and 0 **68_H** **Reset Value**
0000_H

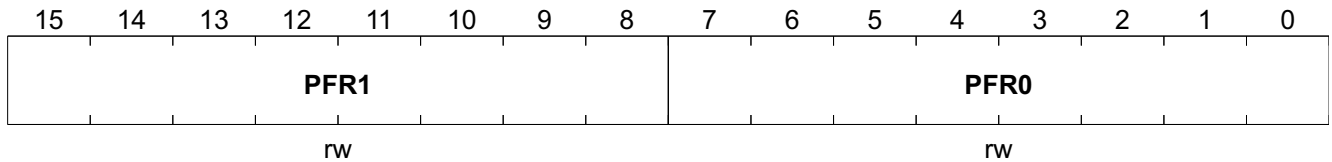

Field	Bits	Type	Description
PFR1	15:8	rw	Value Compared with Protocol in IP Header (Protocol Filter 1, 3, 5, 7)
PFR0	7:0	rw	Value Compared with Protocol in IP Header (Protocol Filter 0, 2, 4, 6)

Similar Registers

All PFx registers have the same structure and characteristics, see [PF_1_0](#).
 The offset addresses of the other PFx registers are listed in [Table 60](#).

Table 60 PFx Registers

Register Short Name	Register Long Name	Offset Address	Page Number
PF_3_2	Protocol Filter 3 and 2	68 _H	
PF_5_4	Protocol Filter 5 and 4	69 _H	
PF_7_6	Protocol Filter 7 and 6	6A _H	

Service Priority Mapping 0

SPM0 **Offset**
Service Priority Mapping 0 **6C_H** **Reset Value**
0000_H

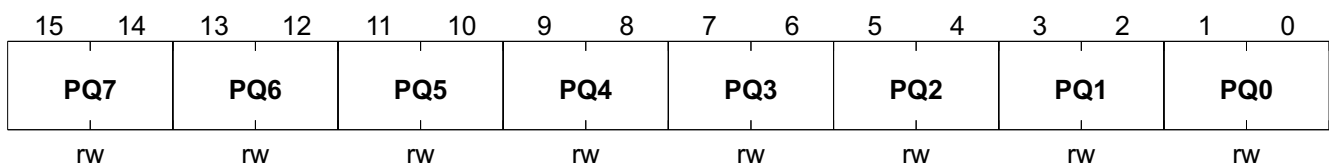

Field	Bits	Type	Description
PQ7	15:14	rw	Priority Queue 7 The value in this field is used as the priority queue when the significant 6 bits in the IPV4 TOS/IPV6 Traffic Class are 000111 _B .

Registers Description

Field	Bits	Type	Description
PQ6	13:12	rw	Priority Queue 6 The value in this field is used as the priority queue when the significant 6 bits in the IPV4 TOS/IPV6 Traffic Class are 000110 _B .
PQ5	11:10	rw	Priority Queue 5 The value in this field is used as the priority queue when the significant 6 bits in the IPV4 TOS/IPV6 Traffic Class are 000101 _B .
PQ4	9:8	rw	Priority Queue 4 The value in this field is used as the priority queue when the significant 6 bits in the IPV4 TOS/IPV6 Traffic Class are 000100 _B .
PQ3	7:6	rw	Priority Queue 3 The value in this field is used as the priority queue when the significant 6 bits in the IPV4 TOS/IPV6 Traffic Class are 000011 _B .
PQ2	5:4	rw	Priority Queue 2 The value in this field is used as the priority queue when the significant 6 bits in the IPV4 TOS/IPV6 Traffic Class are 000010 _B .
PQ1	3:2	rw	Priority Queue 1 The value in this field is used as the priority queue when the significant 6 bits in the IPV4 TOS/IPV6 Traffic Class are 000001 _B .
PQ0	1:0	rw	Priority Queue 0 The value in this field is used as the priority queue when the significant 6 bits in the IPV4 TOS/IPV6 Traffic Class are 000000 _B . 00 _B , Queue 0 01 _B , Queue 1 10 _B , Queue 2 11 _B , Queue 3

Service Priority Mapping 1

SPM1 **Offset** **Reset Value**
Service Priority Mapping 1 **6D_H** **0000_H**

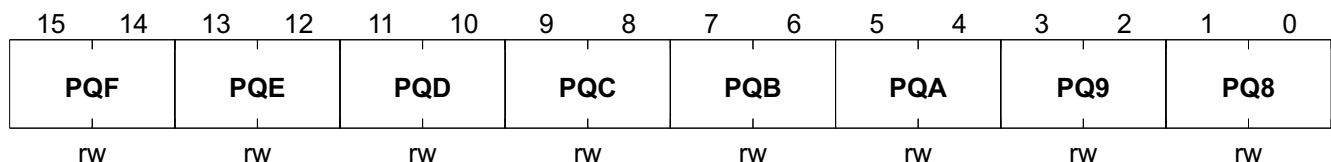

Field	Bits	Type	Description
PQF	15:14	rw	Priority Queue F The value in this field is used as the priority queue when the significant 6 bits in the IPV4 TOS/IPV6 Traffic Class are 001111 _B .
PQE	13:12	rw	Priority Queue E The value in this field is used as the priority queue when the significant 6 bits in the IPV4 TOS/IPV6 Traffic Class are 001110 _B .

Registers Description

Field	Bits	Type	Description
PQD	11:10	rw	Priority Queue D The value in this field is used as the priority queue when the significant 6 bits in the IPV4 TOS/IPV6 Traffic Class are 001101 _B
PQC	9:8	rw	Priority Queue C The value in this field is used as the priority queue when the significant 6 bits in the IPV4 TOS/IPV6 Traffic Class are 001100 _B
PQB	7:6	rw	Priority Queue B The value in this field is used as the priority queue when the significant 6 bits in the IPV4 TOS/IPV6 Traffic Class are 001011 _B
PQA	5:4	rw	Priority Queue A The value in this field is used as the priority queue when the significant 6 bits in the IPV4 TOS/IPV6 Traffic Class are 001010 _B
PQ9	3:2	rw	Priority Queue 9 The value in this field is used as the priority queue when the significant 6 bits in the IPV4 TOS/IPV6 Traffic Class are 001001 _B
PQ8	1:0	rw	Priority Queue 8 The value in this field is used as the priority queue when the significant 6 bits in the IPV4 TOS/IPV6 Traffic Class are 001000 _B

Service Priority Mapping 2

SPM2 **Offset** **Reset Value**
Service Priority Mapping 2 **6E_H** **0000_H**

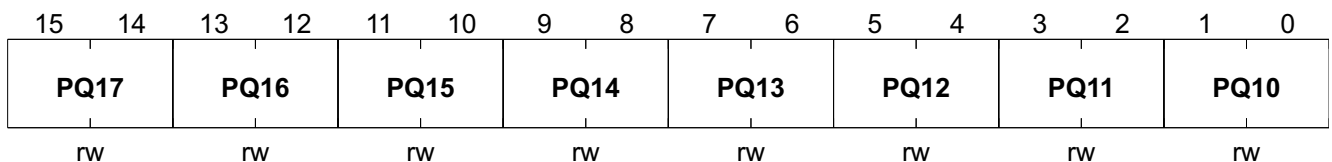

Field	Bits	Type	Description
PQ17	15:14	rw	Priority Queue 17 The value in this field is used as the priority queue when the significant 6 bits in the IPV4 TOS/IPV6 Traffic Class are 010111 _B
PQ16	13:12	rw	Priority Queue 16 The value in this field is used as the priority queue when the significant 6 bits in the IPV4 TOS/IPV6 Traffic Class are 010110 _B
PQ15	11:10	rw	Priority Queue 15 The value in this field is used as the priority queue when the significant 6 bits in the IPV4 TOS/IPV6 Traffic Class are 010101 _B
PQ14	9:8	rw	Priority Queue 14 The value in this field is used as the priority queue when the significant 6 bits in the IPV4 TOS/IPV6 Traffic Class are 010100 _B

Registers Description

Field	Bits	Type	Description
PQ13	7:6	rw	Priority Queue 13 The value in this field is used as the priority queue when the significant 6 bits in the IPV4 TOS/IPV6 Traffic Class are 010011 _B
PQ12	5:4	rw	Priority Queue 12 The value in this field is used as the priority queue when the significant 6 bits in the IPV4 TOS/IPV6 Traffic Class are 010010 _B
PQ11	3:2	rw	Priority Queue 11 The value in this field is used as the priority queue when the significant 6 bits in the IPV4 TOS/IPV6 Traffic Class are 010001 _B
PQ10	1:0	rw	Priority Queue 10 The value in this field is used as the priority queue when the significant 6 bits in the IPV4 TOS/IPV6 Traffic Class are 010000 _B

Service Priority Mapping 3

SPM3 Offset Reset Value
 Service Priority Mapping 3 6F_H 0000_H

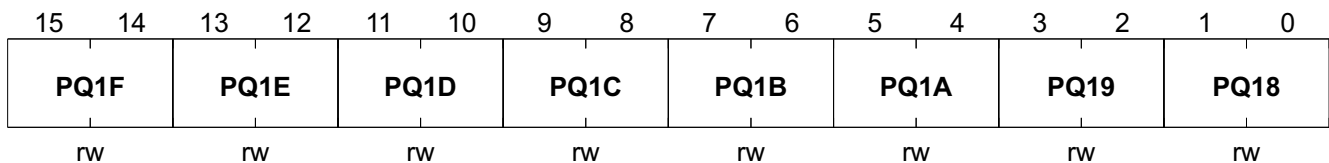

Field	Bits	Type	Description
PQ1F	15:14	rw	Priority Queue 1F The value in this field is used as the priority queue when the significant 6 bits in the IPV4 TOS/IPV6 Traffic Class are 011111 _B
PQ1E	13:12	rw	Priority Queue 1E The value in this field is used as the priority queue when the significant 6 bits in the IPV4 TOS/IPV6 Traffic Class are 011110 _B
PQ1D	11:10	rw	Priority Queue 1D The value in this field is used as the priority queue when the significant 6 bits in the IPV4 TOS/IPV6 Traffic Class are 011101 _B
PQ1C	9:8	rw	Priority Queue 1C The value in this field is used as the priority queue when the significant 6 bits in the IPV4 TOS/IPV6 Traffic Class are 011100 _B
PQ1B	7:6	rw	Priority Queue 1B The value in this field is used as the priority queue when the significant 6 bits in the IPV4 TOS/IPV6 Traffic Class are 011011 _B
PQ1A	5:4	rw	Priority Queue 1A The value in this field is used as the priority queue when the significant 6 bits in the IPV4 TOS/IPV6 Traffic Class are 011010 _B

Registers Description

Field	Bits	Type	Description
PQ19	3:2	rw	Priority Queue 19 The value in this field is used as the priority queue when the significant 6 bits in the IPV4 TOS/IPV6 Traffic Class are 011001 _B
PQ18	1:0	rw	Priority Queue 18 The value in this field is used as the priority queue when the significant 6 bits in the IPV4 TOS/IPV6 Traffic Class are 011000 _B

Service Priority Mapping 4

SPM4 **Offset** **Reset Value**
Service Priority Mapping 4 **70_H** **0000_H**

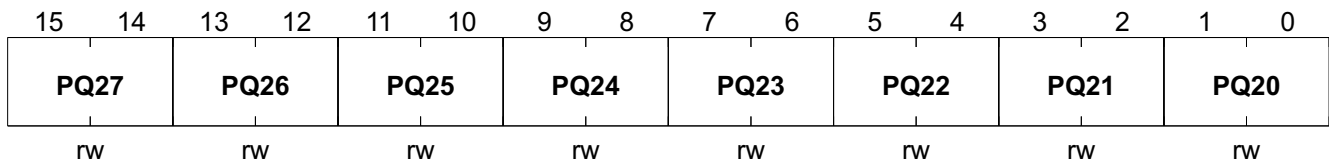

Field	Bits	Type	Description
PQ27	15:14	rw	Priority Queue 27 The value in this field is used as the priority queue when the significant 6 bits in the IPV4 TOS/IPV6 Traffic Class are 100111 _B
PQ26	13:12	rw	Priority Queue 26 The value in this field is used as the priority queue when the significant 6 bits in the IPV4 TOS/IPV6 Traffic Class are 100110 _B
PQ25	11:10	rw	Priority Queue 25 The value in this field is used as the priority queue when the significant 6 bits in the IPV4 TOS/IPV6 Traffic Class are 100101 _B
PQ24	9:8	rw	Priority Queue 24 The value in this field is used as the priority queue when the significant 6 bits in the IPV4 TOS/IPV6 Traffic Class are 100100 _B
PQ23	7:6	rw	Priority Queue 23 The value in this field is used as the priority queue when the significant 6 bits in the IPV4 TOS/IPV6 Traffic Class are 100011 _B
PQ22	5:4	rw	Priority Queue 22 The value in this field is used as the priority queue when the significant 6 bits in the IPV4 TOS/IPV6 Traffic Class are 100010 _B
PQ21	3:2	rw	Priority Queue 21 The value in this field is used as the priority queue when the significant 6 bits in the IPV4 TOS/IPV6 Traffic Class are 100001 _B
PQ20	1:0	rw	Priority Queue 20 The value in this field is used as the priority queue when the significant 6 bits in the IPV4 TOS/IPV6 Traffic Class are 100000 _B

Service Priority Mapping 5

SPM5 **Offset** **Reset Value**
Service Priority Mapping 5 **71_H** **0000_H**

	15	14	13	12	11	10	9	8	7	6	5	4	3	2	1	0
	PQ2F		PQ2E		PQ2D		PQ2C		PQ2B		PQ2A		PQ29		PQ28	
	rw		rw		rw		rw		rw		rw		rw		rw	

Field	Bits	Type	Description
PQ2F	15:14	rw	Priority Queue 2F The value in this field is used as the priority queue when the significant 6 bits in the IPV4 TOS/IPV6 Traffic Class are 101111 _B
PQ2E	13:12	rw	Priority Queue 2E The value in this field is used as the priority queue when the significant 6 bits in the IPV4 TOS/IPV6 Traffic Class are 101110 _B
PQ2D	11:10	rw	Priority Queue 2D The value in this field is used as the priority queue when the significant 6 bits in the IPV4 TOS/IPV6 Traffic Class are 101101 _B
PQ2C	9:8	rw	Priority Queue 2C The value in this field is used as the priority queue when the significant 6 bits in the IPV4 TOS/IPV6 Traffic Class are 101100 _B
PQ2B	7:6	rw	Priority Queue 2B The value in this field is used as the priority queue when the significant 6 bits in the IPV4 TOS/IPV6 Traffic Class are 101011 _B
PQ2A	5:4	rw	Priority Queue 2A The value in this field is used as the priority queue when the significant 6 bits in the IPV4 TOS/IPV6 Traffic Class are 101010 _B
PQ29	3:2	rw	Priority Queue 29 The value in this field is used as the priority queue when the significant 6 bits in the IPV4 TOS/IPV6 Traffic Class are 101001 _B
PQ28	1:0	rw	Priority Queue 28 The value in this field is used as the priority queue when the significant 6 bits in the IPV4 TOS/IPV6 Traffic Class are 101000 _B

Service Priority Mapping 6

SPM6 **Offset** **Reset Value**
Service Priority Mapping 6 **72_H** **0000_H**

Registers Description

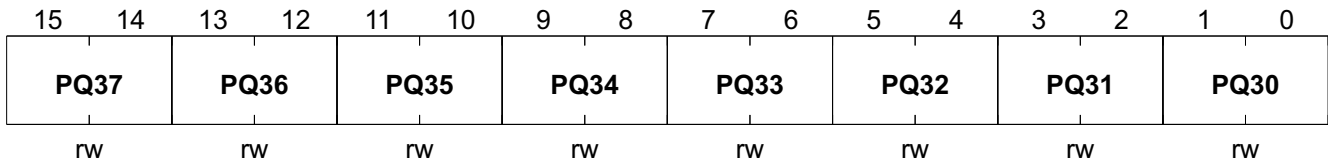

Field	Bits	Type	Description
PQ37	15:14	rw	Priority Queue 37 The value in this field is used as the priority queue when the significant 6 bits in the IPV4 TOS/IPV6 Traffic Class are 110111 _B
PQ36	13:12	rw	Priority Queue 36 The value in this field is used as the priority queue when the significant 6 bits in the IPV4 TOS/IPV6 Traffic Class are 110110 _B
PQ35	11:10	rw	Priority Queue 35 The value in this field is used as the priority queue when the significant 6 bits in the IPV4 TOS/IPV6 Traffic Class are 110101 _B
PQ34	9:8	rw	Priority Queue 34 The value in this field is used as the priority queue when the significant 6 bits in the IPV4 TOS/IPV6 Traffic Class are 110100 _B
PQ33	7:6	rw	Priority Queue 33 The value in this field is used as the priority queue when the significant 6 bits in the IPV4 TOS/IPV6 Traffic Class are 110011 _B
PQ32	5:4	rw	Priority Queue 32 The value in this field is used as the priority queue when the significant 6 bits in the IPV4 TOS/IPV6 Traffic Class are 110010 _B
PQ31	3:2	rw	Priority Queue 31 The value in this field is used as the priority queue when the significant 6 bits in the IPV4 TOS/IPV6 Traffic Class are 110001 _B
PQ30	1:0	rw	Priority Queue 30 The value in this field is used as the priority queue when the significant 6 bits in the IPV4 TOS/IPV6 Traffic Class are 110000 _B

Service Priority Mapping 7

SPM7 **Offset**
Service Priority Mapping 7 **73_H** **Reset Value**
0000_H

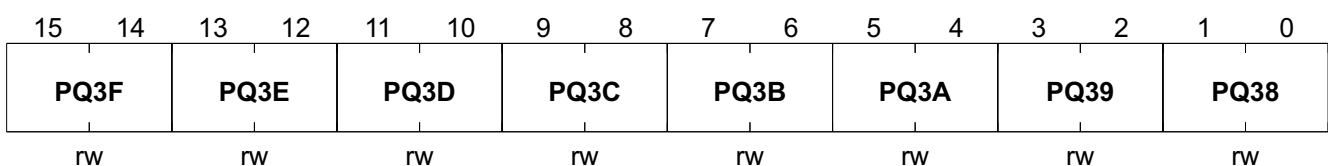

Registers Description

Field	Bits	Type	Description
PQ3F	15:14	rw	Priority Queue 3F The value in this field is used as the priority queue when the significant 6 bits in the IPV4 TOS/IPV6 Traffic Class are 111111 _B
PQ3E	13:12	rw	Priority Queue 3E The value in this field is used as the priority queue when the significant 6 bits in the IPV4 TOS/IPV6 Traffic Class are 111110 _B
PQ3D	11:10	rw	Priority Queue 3D The value in this field is used as the priority queue when the significant 6 bits in the IPV4 TOS/IPV6 Traffic Class are 111101 _B
PQ3C	9:8	rw	Priority Queue 3C The value in this field is used as the priority queue when the significant 6 bits in the IPV4 TOS/IPV6 Traffic Class are 111100 _B
PQ3B	7:6	rw	Priority Queue 3B The value in this field is used as the priority queue when the significant 6 bits in the IPV4 TOS/IPV6 Traffic Class are 111011 _B
PQ3A	5:4	rw	Priority Queue 3A The value in this field is used as the priority queue when the significant 6 bits in the IPV4 TOS/IPV6 Traffic Class are 111010 _B
PQ39	3:2	rw	Priority Queue 39 The value in this field is used as the priority queue when the significant 6 bits in the IPV4 TOS/IPV6 Traffic Class are 111001 _B
PQ38	1:0	rw	Priority Queue 38 The value in this field is used as the priority queue when the significant 6 bits in the IPV4 TOS/IPV6 Traffic Class are 111000 _B

Reserve Action for 0180C2000001~0180C2000000

RA_01_00	Offset	Reset Value
Reserve Action for 0180C2000001~0180C2000000	74 _H	0000 _H

15	14	13	12	11	10	9	8	7	6	5	4	3	2	1	0
RA01_VA*	RA01_SP*	RA01_MG	RA01_CV	RA01_TX TAG	RA01_AC T	RA00_VA*	RA00_SP*	RA00_MG	RA00_CV	RA00_TX TAG	RA00_AC T				
rw	rw	rw	rw	rw	rw	rw	rw	rw	rw	rw	rw	rw	rw	rw	rw

Field	Bits	Type	Description
RA01_VALID	15	rw	Valid bit for 0180C2000001 0 _B , Not Valid 1 _B , Valid
RA01_SPAN	14	rw	Span bit for 0180C2000001 0 _B , Doesn't identify as the span packet 1 _B , Identifies as the span packet

Registers Description

Field	Bits	Type	Description
RA01_MG	13	rw	Management bit for 0180C2000001 0 _B , Doesn't identify as the management packet 1 _B , Identifies as the management packet
RA01_CV	12	rw	Cross_VLAN bit for 0180C2000001 0 _B , Doesn't identify as the cross_VLAN packet 1 _B , Identifies as the cross_VLAN packet
RA01_TXTAG	11:10	rw	TXTAG bit for 0180C2000001 00 _B , System Default Tag 01 _B , Unmodified 10 _B , Always Tagged 11 _B , Always Untagged
RA01_ACT	9:8	rw	Action bit for 0180C2000001 00 _B , Portmap is 111111 _B 01 _B , Portmap is 000000 _B 10 _B , Portmap is the CPU port if the incoming port is not the CPU port. But if the incoming port is the CPU port, then Reserve Portmap contains all the ports, excluding the CPU port 11 _B , Portmap contains all the ports, excluding the CPU port
RA00_VALID	7	rw	Valid bit for 0180C2000000 0 _B , Not Valid 1 _B , Valid
RA00_SPAN	6	rw	Span bit for 0180C2000000 0 _B , Doesn't identify as the span packet 1 _B , Identifies as the span packet
RA00_MG	5	rw	Management bit for 0180C2000000 0 _B , Doesn't identify as the management packet 1 _B , Identifies as the management packet
RA00_CV	4	rw	Cross_VLAN bit for 0180C2000000 0 _B , Doesn't identify as the cross_VLAN packet 1 _B , Identifies as the cross_VLAN packet
RA00_TXTAG	3:2	rw	TXTAG bit for 0180C2000000 00 _B , System Default Tag 01 _B , Unmodified 10 _B , Always Tagged 11 _B , Always Untagged
RA00_ACT	1:0	rw	Action bit for 0180C2000000 00 _B , Portmap is 111111 _B 01 _B , Portmap is 000000 _B 10 _B , Portmap is the CPU port if the incoming port is not the CPU port. But if the incoming port is the CPU port, then Reserve Portmap contains all the ports, excluding the CPU port 11 _B , Portmap contains all the ports, excluding the CPU port

Similar Registers

All RAx registers have the same structure and characteristics, see [RA_01_00](#).
The offset addresses of the other RAx registers are listed in [Table 61](#).

Table 61 RAx Registers

Register Short Name	Register Long Name	Offset Address	Page Number
RA_03_02	Reserve Action for 0180C2000003~0180C2000002	75 _H	
RA_05_04	Reserve Action for 0180C2000005~0180C2000004	76 _H	
RA_07_06	Reserve Action for 0180C2000007~0180C2000006	77 _H	
RA_09_08	Reserve Action for 0180C2000009~0180C2000008	78 _H	
RA_0B_0A	Reserve Action for 0180C200000B~0180C200000A	79 _H	
RA_0D_0C	Reserve Action for 0180C200000D~0180C200000C	7A _H	
RA_0F_0E	Reserve Action for 0180C200000F~0180C200000E	7B _H	
RA_11_10	Reserve Action for 0180C2000011~0180C2000010	7C _H	
RA_13_12	Reserve Action for 0180C2000013~0180C2000012	7D _H	
RA_15_14	Reserve Action for 0180C2000015~0180C2000014	7E _H	
RA_17_16	Reserve Action for 0180C2000017~0180C2000016	7F _H	
RA_19_18	Reserve Action for 0180C2000019~0180C2000018	80 _H	
RA_1B_1A	Reserve Action for 0180C200001B~0180C200001A	81 _H	
RA_1D_1C	Reserve Action for 0180C200001D~0180C200001C	82 _H	
RA_1F_1E	Reserve Action for 0180C200001F~0180C200001E	83 _H	
RA_21_20	Reserve Action for 0180C2000021~0180C2000020	84 _H	
RA_23_22	Reserve Action for 0180C2000023~0180C2000022	85 _H	
RA_25_24	Reserve Action for 0180C2000025~0180C2000024	86 _H	
RA_27_26	Reserve Action for 0180C2000027~0180C2000026	87 _H	
RA_29_28	Reserve Action for 0180C2000029~0180C2000028	88 _H	
RA_2B_2A	Reserve Action for 0180C200002B~0180C200002A	89 _H	

Registers Description

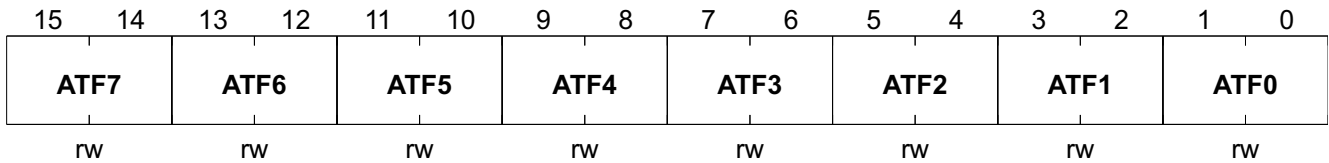

Field	Bits	Type	Description
ATF7	15:14	rw	Action for Type Filter 7 See register 0094 _H , ATF0 for more details.
ATF6	13:12	rw	Action for Type Filter 6 See register 0094 _H , ATF0 for more details.
ATF5	11:10	rw	Action for Type Filter 5 See register 0094 _H , ATF0 for more details.
ATF4	9:8	rw	Action for Type Filter 4 See register 0094 _H , ATF0 for more details.
ATF3	7:6	rw	Action for Type Filter 3 See register 0094 _H , ATF0 for more details.
ATF2	5:4	rw	Action for Type Filter 2 See register 0094 _H , ATF0 for more details.
ATF1	3:2	rw	Action for Type Filter 1 See register 0094 _H , ATF0 for more details.
ATF0	1:0	rw	Action for Type Filter 0 00 _B , Type Portmap is Default Output Ports 01 _B , Type Portmap is 000000 _B 10 _B , Type Portmap is the CPU port if the incoming port is not the CPU port. But if the incoming port is the CPU port, then Type Portmap contains Default Output Ports , excluding the CPU port 11 _B , Type Portmap contains Default Output Port, excluding the CPU port

Protocol Filter Action

PFA	Offset	Reset Value
Protocol Filter Action	95_H	0000_H

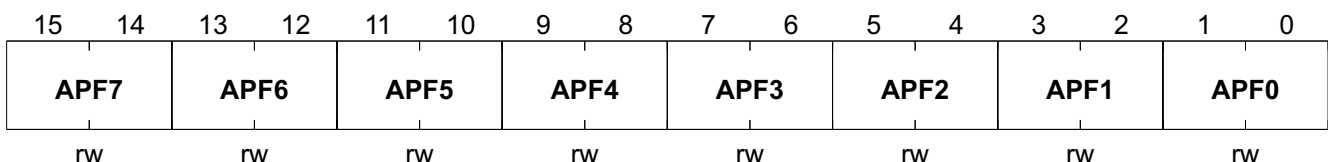

Field	Bits	Type	Description
APF7	15:14	rw	Action for Protocol Filter 7 See register 0095 _H , APF0 for more details.

Registers Description

Field	Bits	Type	Description
ATUF0	3:2	rw	Action for TCP/UDP Filter 0 00 _B , Protocol Portmap is Default Output Ports 01 _B , Protocol Portmap is 000000 _B 10 _B , Protocol Portmap is the CPU port if the incoming port is not the CPU port. But if the incoming port is the CPU port, then Type Portmap contains Default Output Ports, excluding the CPU port 11 _B , Protocol Portmap contains Default Output Ports, excluding the CPU port
TUPF0	1:0	rw	TCP/UDP PRI for TCP/UDP Filter 0 00 _B , Queue 0 01 _B , Queue 1 10 _B , Queue 2 11 _B , Queue 3

TCP/UDP Action 1

TUA1	Offset	Reset Value
TCP/UDP Action 1	97_H	0000_H

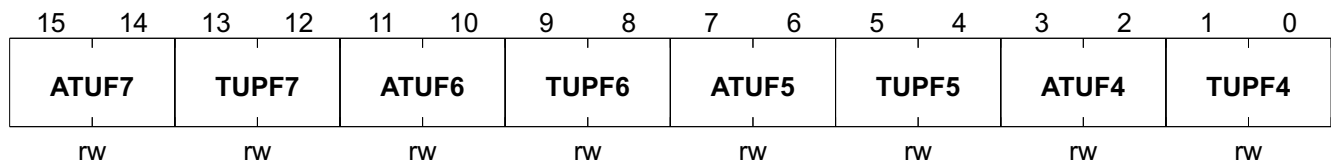

Field	Bits	Type	Description
ATUF7	15:14	rw	Action for TCP/UDP Filter 7 See register 0096 _H , ATUF0 for more details.
TUPF7	13:12	rw	TCP/UDP PRI for TCP/UDP Filter 7 See register 0096 _H , TUPF0 for more details.
ATUF6	11:10	rw	Action for TCP/UDP Filter 6 See register 0096 _H , ATUF0 for more details.
TUPF6	9:8	rw	TCP/UDP PRI for TCP/UDP Filter 6 See register 0096 _H , TUPF0 for more details.
ATUF5	7:6	rw	Action for TCP/UDP Filter 5 See register 0096 _H , ATUF0 for more details.
TUPF5	5:4	rw	TCP/UDP PRI for TCP/UDP Filter 5 See register 0096 _H , TUPF0 for more details.
ATUF4	3:2	rw	Action for TCP/UDP Filter 4 See register 0096 _H , ATUF0 for more details.
TUPF4	1:0	rw	TCP/UDP PRI for TCP/UDP Filter 4 See register 0096 _H , TUPF0 for more details.

TCP/UDP Action 2

TUA2 Offset Reset Value
TCP/UDP Action 2 98_H 0000_H

15	14	13	12	11	10	9	8	7	6	5	4	3	2	1	0
Res	COMP	P5I	P4I	P3I	P2I	P1I	P0I	P5T	P4T	P3T	P2T	P1T	P0T		
r	rw	rw	rw	rw	rw	rw	rw	rw	rw	rw	rw	rw	rw	rw	

Field	Bits	Type	Description
Res	15:14	r	Reserved
COMP	13:12	rw	Compare TCP/UDP Source Port or Destination Port 00 _B , Doesn't Compare 01 _B , Compares Destination Port 10 _B , Compares Source Port 11 _B , Compares Destination Port or Source Port
P5I	11	rw	Port 5 IP over TCP/UDP 0 _B , Uses TCP/UDP field when packets contain both TCP/UDP and IP 1 _B , Uses IP field when packets contain both TCP/UDP and IP
P4I	10	rw	Port 4 IP over TCP/UDP 0 _B , Uses TCP/UDP field when packets contain both TCP/UDP and IP 1 _B , Uses IP field when packets contain both TCP/UDP and IP
P3I	9	rw	Port 3 IP over TCP/UDP 0 _B , Uses TCP/UDP field when packets contain both TCP/UDP and IP 1 _B , Uses IP field when packets contain both TCP/UDP and IP
P2I	8	rw	Port 2 IP over TCP/UDP 0 _B , Uses TCP/UDP field when packets contain both TCP/UDP and IP 1 _B , Uses IP field when packets contain both TCP/UDP and IP
P1I	7	rw	Port 1 IP over TCP/UDP 0 _B , Uses TCP/UDP field when packets contain both TCP/UDP and IP 1 _B , Uses IP field when packets contain both TCP/UDP and IP
P0I	6	rw	Port 0 IP over TCP/UDP 0 _B , Uses TCP/UDP field when packets contain both TCP/UDP and IP 1 _B , Uses IP field when packets contain both TCP/UDP and IP
P5T	5	rw	Port 5 TCP/UDP PRIEN 0 _B , Doesn't use TCP/UDP priority 1 _B , Uses TCP/UDP priority
P4T	4	rw	Port 4 TCP/UDP PRIEN 0 _B , Doesn't use TCP/UDP priority 1 _B , Uses TCP/UDP priority
P3T	3	rw	Port 3 TCP/UDP PRIEN 0 _B , Doesn't use TCP/UDP priority 1 _B , Uses TCP/UDP priority

Registers Description

Field	Bits	Type	Description
P2T	2	rw	Port 2 TCP/UDP PRIEN 0 _B , Doesn't use TCP/UDP priority 1 _B , Uses TCP/UDP priority
P1T	1	rw	Port 1 TCP/UDP PRIEN 0 _B , Doesn't use TCP/UDP priority 1 _B , Uses TCP/UDP priority
P0T	0	rw	Port 0 TCP/UDP PRIEN 0 _B , Doesn't use TCP/UDP priority 1 _B , Uses TCP/UDP priority

Extended IGMP Control/Special Tag Insert Control

EICSTIC	Offset	Reset Value
Extended IGMP Control/Special Tag Insert Control	99_H	01FF_H

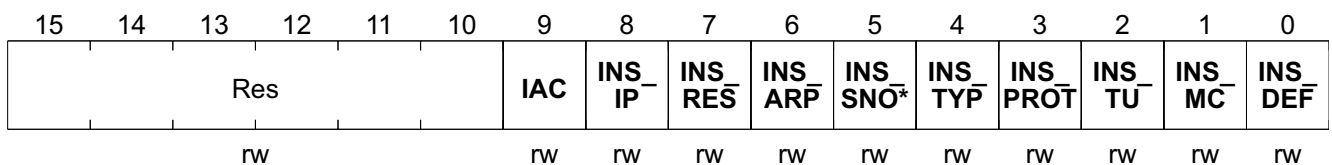

Field	Bits	Type	Description
Res	15:10	rw	Reserved
IAC	9	rw	Include Address Change into Port Security Interrupt Source 0 _B , Doesn't include 1 _B , Includes
INS_IP	8	rw	Insert Special Tag in IP Packet. (not in the TYPE/Protocol/TCPUDP) 0 _B , Doesn't insert 1 _B , Inserts
INS_RES	7	rw	Insert Special Tag in Reserve Packet. 0 _B , Doesn't insert 1 _B , Inserts
INS_ARP	6	rw	Insert Special Tag in ARP/RARP Packet. 0 _B , Doesn't insert 1 _B , Inserts
INS_SNOOP	5	rw	Insert Special Tag in IGMP/MLD Packet. 0 _B , Doesn't insert 1 _B , Inserts
INS_TYP	4	rw	Insert Special Tag if Type field matches with pre-defined rules. 0 _B , Doesn't insert 1 _B , Inserts

Registers Description

Field	Bits	Type	Description
INS_PROT	3	rw	Insert Special Tag if Protocol field matches with pre-defined rules. 0 _B , Doesn't insert 1 _B , Inserts
INS_TU	2	rw	Insert Special Tag if Port field matches with pre-defined rules. 0 _B , Doesn't insert 1 _B , Inserts
INS_MC	1	rw	Insert Special Tag in MAC Control Packet. 0 _B , Doesn't insert 1 _B , Inserts
INS_DEF	0	rw	Insert Special Tag in the packets except those packets defined in bit 8 ~ 1. 0 _B , Doesn't insert 1 _B , Inserts

Interrupt Enable Register

IE **Offset**
9A_H **Reset Value**
0000_H
Interrupt Enable Register

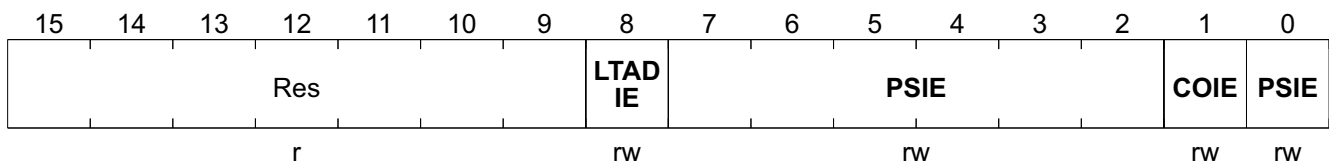

Field	Bits	Type	Description
Res	15:9	r	Reserved
LTADIE	8	rw	Leaning Table Access Done Interrupt Enable 0 _B , Interrupt disable 1 _B , Interrupt enable
PSIE	7:2	rw	Port Security Interrupt Enable It's a per port setting 0 _B , Interrupt disable 1 _B , Interrupt enable
COIE	1	rw	Counter Overflow Interrupt Enable 0 _B , Interrupt disable 1 _B , Interrupt enable
PSIE	0	rw	Port Status Interrupt Enable 0 _B , Interrupt disable 1 _B , Interrupt enable

Interrupt Status Register

IS **Offset** **Reset Value**
Interrupt Status Register **9B_H** **0000_H**

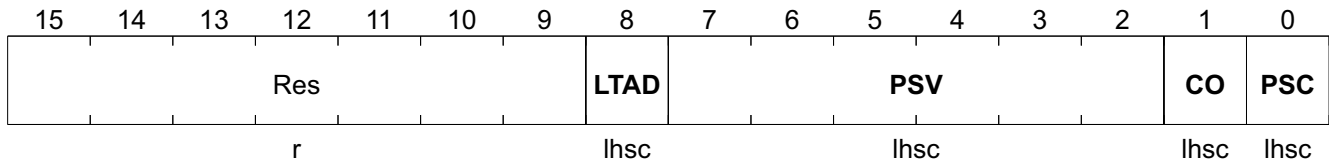

Field	Bits	Type	Description
Res	15:9	r	Reserved
LTAD	8	lhsc	Leaning Table Access Done 0 _B , Access does not end 1 _B , Access end
PSV	7:2	lhsc	Port Security Violation It's a per port setting 0 _B , Security did not violate 1 _B , Security violated
CO	1	lhsc	Counter Overflow 0 _B , Overflow did not happen 1 _B , Overflow happened for any of the counters
PSC	0	lhsc	Port Status Change 0 _B , No status (link, speed, duplex, flow control) changed for any port 1 _B , Status changed for any of 6 ports

Security Control Register

SC **Offset** **Reset Value**
Security Control Register **9C_H** **0000_H**

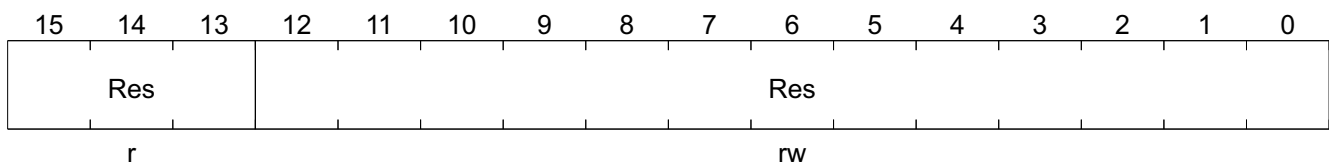

Field	Bits	Type	Description
Res	15:13	r	Reserved
Res	12:0	rw	Reserved

Field	Bits	Type	Description
Res	15:12	ro	Reserved
P1FCS	11	ro	Port 1 Flow Control Status 0 _B , Port 1 disables the Full Flow Control/Half Back Pressure Function 1 _B , Port 1 enables the Full Flow Control/Half Back Pressure Function
P1DS	10	ro	Port 1 Duplex Status 0 _B , Port 1 operates in the Half Duplex 1 _B , Port 1 operates in the Full Duplex
P1SS	9	ro	Port 1 Speed Status 0 _B , Port 1 operates in the 10M 1 _B , Port 1 operates in the 100M
P1LS	8	ro	Port 1 Link Status 0 _B , Port 1 links down 1 _B , Port 1 links up
Res	7:4	ro	Reserved
P0FCS	3	ro	Port 0 Flow Control Status 0 _B , Port 0 disables the Full Flow Control/Half Back Pressure Function 1 _B , Port 0 enables the Full Flow Control/Half Back Pressure Function
P0DS	2	ro	Port 0 Duplex Status 0 _B , Port 0 operates in the Half Duplex 1 _B , Port 0 operates in the Full Duplex
P0SS	1	ro	Port 0 Speed Status 0 _B , Port 0 operates in the 10M 1 _B , Port 0 operates in the 100M
P0LS	0	ro	Port 0 Link Status 0 _B , Port 0 links down 1 _B , Port 0 links up

Port Status 1

PS1 **Offset** **Reset Value**
Port Status 1 **A3_H** **0000_H**

15	14	13	12	11	10	9	8	7	6	5	4	3	2	1	0
P4FCS	P4DS	P4SS	P4LS	P3FCS	P3DS	P3SS	P3LS	Res				P2FCS	P2DS	P2SS	P2LS
ro	ro	ro	ro	ro	ro	ro	ro					ro	ro	ro	ro

Field	Bits	Type	Description
P4FCS	15	ro	Port 4 Flow Control Status 0 _B , Port 4 disables the Full Flow Control/Half Back Pressure Function 1 _B , Port 4 enables the Full Flow Control/Half Back Pressure Function

Registers Description

Field	Bits	Type	Description
P4DS	14	ro	Port 4 Duplex Status 0 _B , Port 4 operates in the Half Duplex 1 _B , Port 4 operates in the Full Duplex
P4SS	13	ro	Port 4 Speed Status 0 _B , Port 4 operates in the 10M 1 _B , Port 4 operates in the 100M
P4LS	12	ro	Port 4 Link Status 0 _B , Port 4 links down 1 _B , Port 4 links up
P3FCS	11	ro	Port 3 Flow Control Status 0 _B , Port 3 disables the Full Flow Control/Half Back Pressure Function 1 _B , Port 3 enables the Full Flow Control/Half Back Pressure Function
P3DS	10	ro	Port 3 Duplex Status 0 _B , Port 3 operates in the Half Duplex 1 _B , Port 3 operates in the Full Duplex
P3SS	9	ro	Port 3 Speed Status 0 _B , Port 3 operates in the 10M 1 _B , Port 3 operates in the 100M
P3LS	8	ro	Port 3 Link Status 0 _B , Port 3 links down 1 _B , Port 3 links up.
Res	7:4	ro	Reserved
P2FCS	3	ro	Port 2 Flow Control Status 0 _B , Port 2 disables the Full Flow Control/Half Back Pressure Function 1 _B , Port 2 enables the Full Flow Control/Half Back Pressure Function
P2DS	2	ro	Port 2 Duplex Status 0 _B , Port 2 operates in the Half Duplex 1 _B , Port 2 operates in the Full Duplex
P2SS	1	ro	Port 2 Speed Status 0 _B , Port 2 operates in the 10M 1 _B , Port 2 operates in the 100M
P2LS	0	ro	Port 2 Link Status 0 _B , Port 2 links down 1 _B , Port 2 links up

Port Status 2

PS2 **Offset** **Reset Value**
Port Status 2 **A4_H** **0000_H**

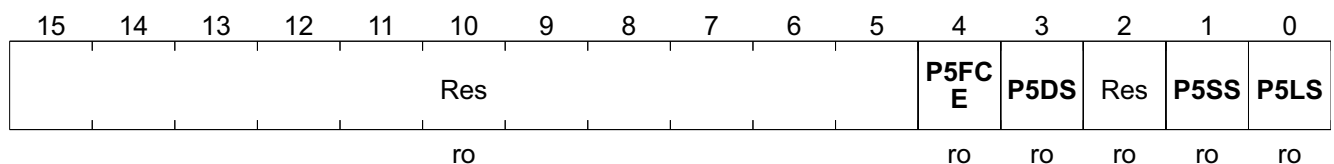

Registers Description

Field	Bits	Type	Description
Res	15:5	ro	Reserved
P5FCE	4	ro	Port 5 Flow Control Enable 0 _B , Port 5 disables the Full Flow Control/Half Back Pressure Function 1 _B , Port 5 enables the Full Flow Control/Half Back Pressure Function
P5DS	3	ro	Port 5 Duplex Status 0 _B , Port 5 operates in the Half Duplex 1 _B , Port 5 operates in the Full Duplex
Res	2	ro	Reserved
P5SS	1	ro	Port 5 Speed Status 0 _B , Port 5 operates in the 10M 1 _B , Port 5 operates in the 100M
P5LS	0	ro	Port 5 Link Status 0 _B , Port 5 links down 1 _B , Port 5 links up

Port Status 3

PS3 **Offset**
Port Status 3 **A5_H** **Reset Value**
0000_H

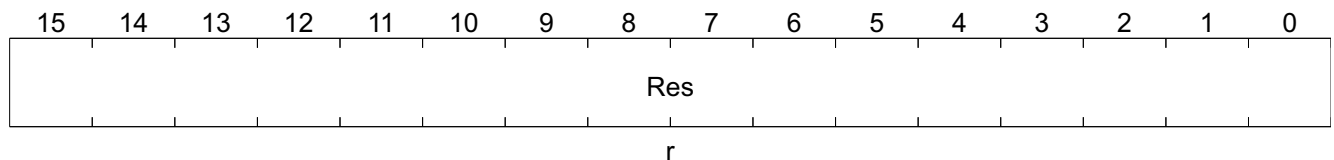

Field	Bits	Type	Description
Res	15:0	r	Reserved

Cable Broken 0

CB0 **Offset**
Cable Broken 0 **A6_H** **Reset Value**
0000_H

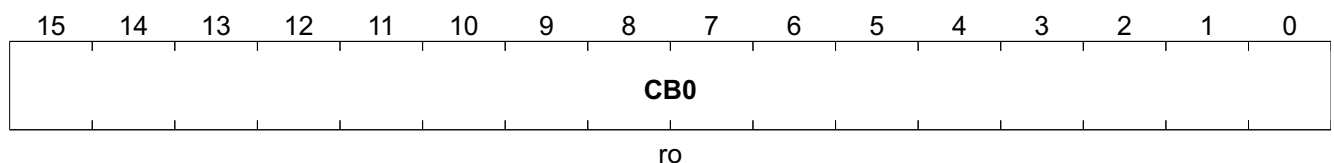

Field	Bits	Type	Description
CB0	15:0	ro	Reserved

Similar Registers

All CHx registers have the same structure and characteristics, see [CH0](#).
The offset addresses of the other CLH registers are listed in [Table 64](#).

Table 64 CHx Registers

Register Short Name	Register Long Name	Offset Address	Page Number
CH1	Port 1 Receive Packet Counter High	AD _H	
CH2	Port 2 Receive Packet Counter High	B1 _H	
CH3	Port 3 Receive Packet Counter High	B5 _H	
CH4	Port 4 Receive Packet Counter High	B7 _H	
CH5	Port 5 Receive Packet Counter High	B9 _H	
CH6	Port 0 Receive Packet Byte Count High	BB _H	
CH7	Port 1 Receive Packet Byte Count High	BF _H	
CH8	Port 2 Receive Packet Byte Count High	C3 _H	
CH9	Port 3 Receive Packet Byte Count High	C7 _H	
CH10	Port 4 Receive Packet Byte Count High	C9 _H	
CH11	Port 5 Receive Packet Byte Count High	CB _H	
CH12	Port 0 Transmit Packet Count High	CD _H	
CH13	Port 1 Transmit Packet Count High	D1 _H	
CH14	Port 2 Transmit Packet Count High	D5 _H	
CH15	Port 3 Transmit Packet Count High	D9 _H	
CH16	Port 4 Transmit Packet Count High	DB _H	
CH17	Port 5 Transmit Packet Count High	DD _H	
CH18	Port 0 Transmit Packet Byte Count High	DF _H	
CH19	Port 1 Transmit Packet Byte Count High	E3 _H	
CH20	Port 2 Transmit Packet Byte Count High	E7 _H	
CH21	Port 3 Transmit Packet Byte Count High	EB _H	
CH22	Port 4 Transmit Packet Byte Count High	ED _H	
CH23	Port 5 Transmit Packet Byte Count High	EF _H	
CH24	Port 0 Collision Count High	F1 _H	
CH25	Port 1 Collision Count High	F5 _H	
CH26	Port 2 Collision Count High	F9 _H	
CH27	Port 3 Collision Count High	FD _H	
CH28	Port 4 Collision Count High	FF _H	
CH29	Port 5 Collision Count High	101 _H	
CH30	Port 0 Error Count High	103 _H	
CH31	Port 1 Error Count High	107 _H	
CH32	Port 2 Error Count High	10B _H	
CH33	Port 3 Error Count High	10F _H	
CH34	Port 4 Error Count High	111 _H	
CH35	Port 5 Error Count High	113 _H	

Over-Flow Flag 0

OFF0 **Offset** **Reset Value**
Over-Flow Flag 0 **114_H** **0000_H**

15	14	13	12	11	10	9	8	7	6	5	4	3	2	1	0
P3_B C	Res	P2_B C	Res	P1_B C	Res	P0_B C	P5_C	P4_C	P3_C	Res	P2_C	Res	P1_C	Res	P0_C
lhsc	ro	lhsc	ro	lhsc	ro	lhsc	lhsc	lhsc	lhsc	ro	lhsc	ro	lhsc	ro	lhsc

Field	Bits	Type	Description
P3_BC	15	lhsc	Overflow of Port 3 Receive Packet Byte Count 0 _B , No overflow 1 _B , Overflow
Res	14	ro	Reserved
P2_BC	13	lhsc	Overflow of Port 2 Receive Packet Byte Count 0 _B , No overflow 1 _B , Overflow
Res	12	ro	Reserved
P1_BC	11	lhsc	Overflow of Port 1 Receive Packet Byte Count 0 _B , No overflow 1 _B , Overflow
Res	10	ro	Reserved
P0_BC	9	lhsc	Overflow of Port 0 Receive Packet Byte Count 0 _B , No overflow 1 _B , Overflow
P5_C	8	lhsc	Overflow of Port 5 Receive Packet Count 0 _B , No overflow 1 _B , Overflow
P4_C	7	lhsc	Overflow of Port 4 Receive Packet Count 0 _B , No overflow 1 _B , Overflow
P3_C	6	lhsc	Overflow of Port 3 Receive Packet Count 0 _B , No overflow 1 _B , Overflow
Res	5	ro	Reserved
P2_C	4	lhsc	Overflow of Port 2 Receive Packet Count 0 _B , No overflow 1 _B , Overflow
Res	3	ro	Reserved
P1_C	2	lhsc	Overflow of Port 1 Receive Packet Count 0 _B , No overflow 1 _B , Overflow
Res	1	ro	Reserved

Registers Description

Field	Bits	Type	Description
P0_C	0	lhsc	Overflow of Port 0 Receive Packet Count 0 _B , No overflow 1 _B , Overflow

Over-Flow Flag 1

OFF1	Offset	Reset Value
Over-Flow Flag 1	115_H	0000_H

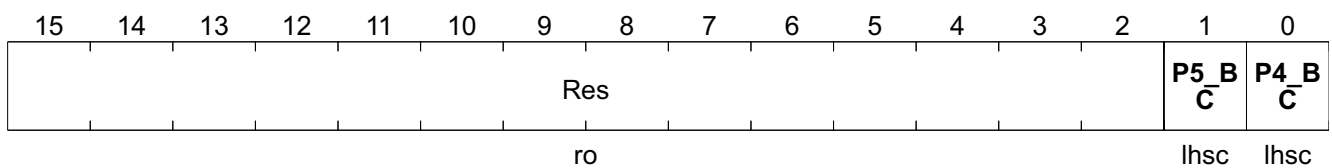

Field	Bits	Type	Description
Res	15:2	ro	Reserved
P5_BC	1	lhsc	Overflow of Port 5 Receive Packet Byte Count 0 _B , No overflow 1 _B , Overflow
P4_BC	0	lhsc	Overflow of Port 4 Receive Packet Byte Count 0 _B , No overflow 1 _B , Overflow

Over-Flow Flag 2

OFF2	Offset	Reset Value
Over-Flow Flag 2	116_H	0000_H

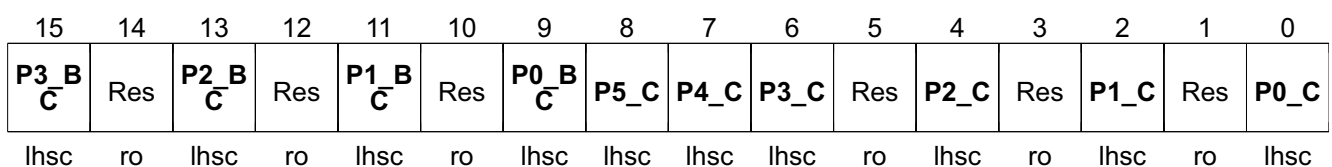

Field	Bits	Type	Description
P3_BC	15	lhsc	Overflow of Port 3 Transmit Packet Byte Count 0 _B , No overflow 1 _B , Overflow
Res	14	ro	Reserved
P2_BC	13	lhsc	Overflow of Port 2 Transmit Packet Byte Count 0 _B , No overflow 1 _B , Overflow

Registers Description

Field	Bits	Type	Description
P5_BC	1	lhsc	Overflow of Port 5 Transmit Packet Byte Count 0 _B , No overflow 1 _B , Overflow
P4_BC	0	lhsc	Overflow of Port 4 Transmit Packet Byte Count 0 _B , No overflow 1 _B , Overflow

Over-Flow Flag 4

OFF4 **Offset** **Reset Value**
Over-Flow Flag 4 **118_H** **0000_H**

15	14	13	12	11	10	9	8	7	6	5	4	3	2	1	0
P3EC	Res	P2EC	Res	P1EC	Res	P0EC	P5CC	P4CC	P3CC	Res	P2CC	Res	P1CC	Res	P0CC
lhsc	ro	lhsc	ro	lhsc	ro	lhsc	lhsc	lhsc	lhsc	ro	lhsc	ro	lhsc	ro	lhsc

Field	Bits	Type	Description
P3EC	15	lhsc	Overflow of Port 3 Error Count 0 _B , No overflow 1 _B , Overflow
Res	14	ro	Reserved
P2EC	13	lhsc	Overflow of Port 2 Error Count 0 _B , No overflow 1 _B , Overflow
Res	12	ro	Reserved
P1EC	11	lhsc	Overflow of Port 1 Error Count 0 _B , No overflow 1 _B , Overflow
Res	10	ro	Reserved
P0EC	9	lhsc	Overflow of Port 0 Error Count 0 _B , No overflow 1 _B , Overflow
P5CC	8	lhsc	Overflow of Port 5 Collision Count 0 _B , No overflow 1 _B , Overflow
P4CC	7	lhsc	Overflow of Port 4 Collision Count 0 _B , No overflow 1 _B , Overflow
P3CC	6	lhsc	Overflow of Port 3 Collision Count 0 _B , No overflow 1 _B , Overflow
Res	5	ro	Reserved

Registers Description

Field	Bits	Type	Description
P2CC	4	lhsc	Overflow of Port 2 Collision Count 0 _B , No overflow 1 _B , Overflow
Res	3	ro	Reserved
P1CC	2	lhsc	Overflow of Port 1 Collision Count 0 _B , No overflow 1 _B , Overflow
Res	1	ro	Reserved
P0CC	0	lhsc	Overflow of Port 0 Collision Count 0 _B , No overflow 1 _B , Overflow

Over-Flow Flag 5

OFF5 **Offset**
Over-Flow Flag 5 **119_H** **Reset Value**
0000_H

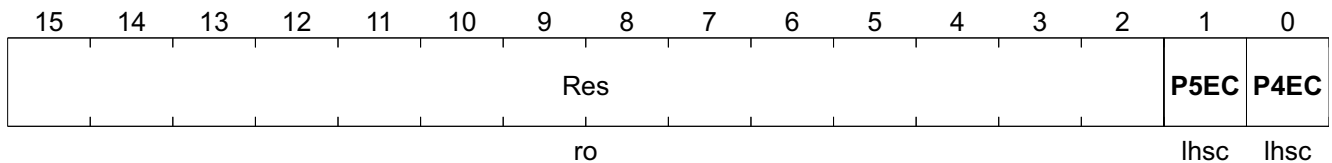

Field	Bits	Type	Description
Res	15:2	ro	Reserved
P5EC	1	lhsc	Overflow of Port 5 Error Count 0 _B , No overflow 1 _B , Overflow
P4EC	0	lhsc	Overflow of Port 4 Error Count 0 _B , No overflow 1 _B , Overflow

Hardware Setting Low Register

HSL **Offset**
Hardware Setting Low Register **130_H** **Reset Value**
0000_H

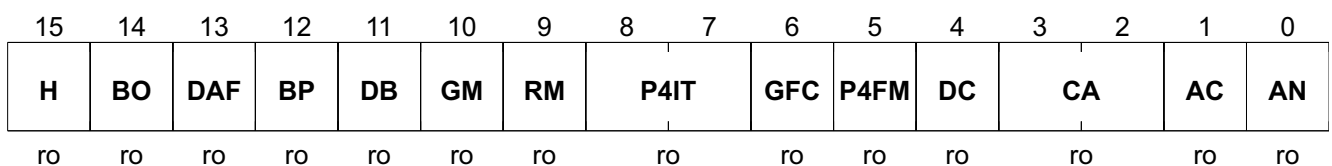

Field	Bits	Type	Description
H	15	ro	Reserved
BO	14	ro	Bond
DAF	13	ro	Disable Samurai-6M/6MX (ADM6996M/MX) Function
BP	12	ro	BPEN
DB	11	ro	16/32 Bit Data Bus
GM	10	ro	GPSI Mode
RM	9	ro	RMI Mode
P4IT	8:7	ro	Port 4 Interface Type
GFC	6	ro	Global Flow Control
P4FM	5	ro	Port 4 Fiber Mode
DC	4	ro	Dual Color
CA	3:2	ro	Chip Address
AC	1	ro	Auto-Crossover
AN	0	ro	Auto-Negotiation

Hardware Setting High Register

HSH Offset
Hardware Setting High Register 131_H Reset Value
0000_H

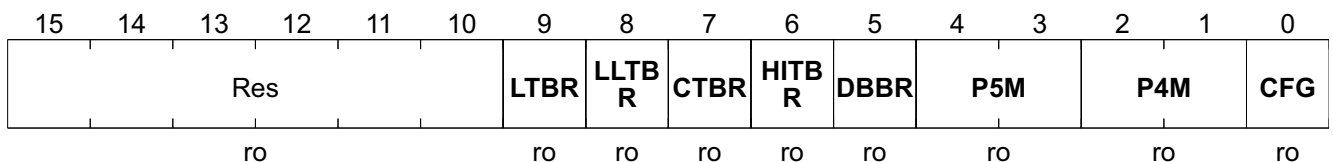

Field	Bits	Type	Description
Res	15:10	ro	Reserved
LTBR	9	ro	Learning Table Bist Result 0 _B , Works 1 _B , Doesn't Work
LLTBR	8	ro	Linklist Table Bist Result (Linklist Table does not do bist test in normal mode) 0 _B , Works 1 _B , Doesn't Work
CTBR	7	ro	Control Table Bist Result 0 _B , Works 1 _B , Doesn't Work
HITBR	6	ro	Hardware IGMP Table Bist Result 0 _B , Works 1 _B , Doesn't Work

Registers Description

Field	Bits	Type	Description
DBBR	5	ro	Data Buffer Bist Result 0 _B , Works 1 _B , Doesn't Work
P5M	4:3	ro	P5 Mode 00 _B , GPSI 01 _B , RMII 10 _B , MII
P4M	2:1	ro	P4 Mode 00 _B , Port 4 uses inner PHY 01 _B , Port 4 uses MII 11 _B , Port 4 isolated PHY
CFG	0	ro	CFG

Assign Address [15:0] Register

AA1	Offset	Reset Value
Assign Address [15:0] Register	132 _H	0000 _H

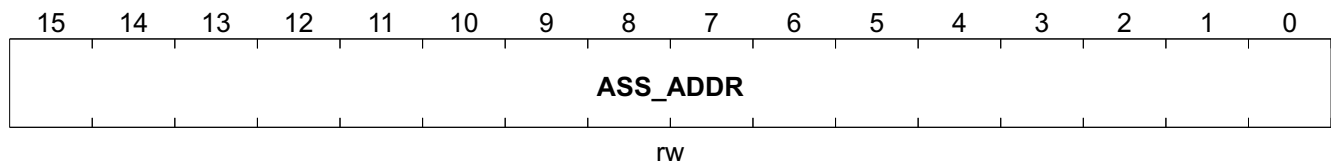

Field	Bits	Type	Description
ASS_ADDR	15:0	rw	Assign Address [15:0]

Assign Address [31:16] Register

AA2	Offset	Reset Value
Assign Address [31:16] Register	133 _H	0000 _H

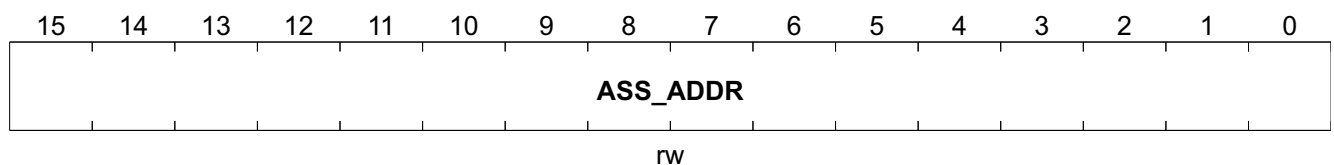

Field	Bits	Type	Description
ASS_ADDR	15:0	rw	Assign Address [31:16]

Assign Address [47:32] Register

AA3 **Offset**
Assign Address [47:32] Register **134_H** **Reset Value**
0000_H

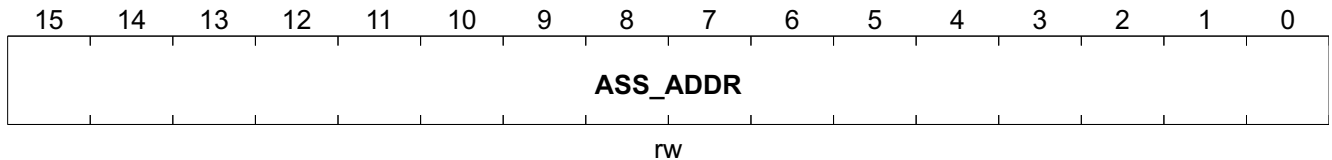

Field	Bits	Type	Description
ASS_ADDR	15:0	rw	Assign Address [47:32]

Assign Option Register

AO **Offset**
Assign Option Register **135_H** **Reset Value**
0000_H

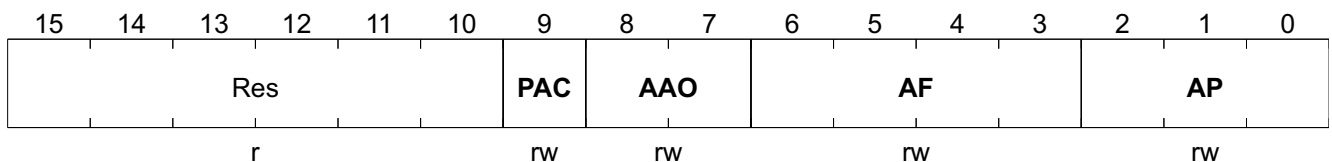

Field	Bits	Type	Description
Res	15:10	r	Reserved
PAC	9	rw	<p>Pause Address Change</p> <p>It is useful only when assigned address is used for PAUSE source address</p> <p>0_B , All the ports use this assigned address as the source address of the PAUSE commands</p> <p>1_B , Port 0 uses {assigned address[47:3], 000_B} as the source address of the PAUSE commands. Port 1 uses {assigned address[47:3], 001_B} as the source address of the PAUSE commands. Port 2 uses {assigned address[47:3], 010_B} as the source address of the PAUSE commands. Port 3 uses {assigned address[47:3], 011_B} as the source address of the PAUSE commands. Port 4 uses {assigned address[47:3], 100_B} as the source address of the PAUSE commands. Port 5 uses {assigned address[47:3], 101_B} as the source address of the PAUSE commands.</p>

Registers Description

Field	Bits	Type	Description
AAO	8:7	rw	Assign Address Option 00 _B , Assigned address is useless 01 _B , Assigned address is used for PAUSE source address 10 _B , Assigned address is used for assigned lock address or the monitor address 11 _B , Assigned address is used for PAUSE source address
AF	6:3	rw	Assign Fid It is used for to assign lock FID.
AP	2:0	rw	Assign Port It is used for the port that the user wants to assign or for the monitor port.

Mirror Register 0

MIRRO	Offset	Reset Value
Mirror Register 0	136_H	0000_H

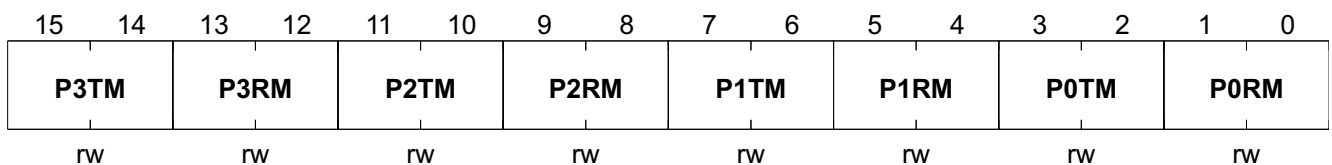

Field	Bits	Type	Description
P3TM	15:14	rw	Port 3 Transmit Mirror Option See register 0136 _H , P0TM for more details.
P3RM	13:12	rw	Port 3 Receive Mirror Option See register 0136 _H , P0RM for more details.
P2TM	11:10	rw	Port 2 Transmit Mirror Option See register 0136 _H , P0TM for more details.
P2RM	9:8	rw	Port 2 Receive Mirror Option See register 0136 _H , P0RM for more details.
P1TM	7:6	rw	Port 1 Transmit Mirror Option See register 0136 _H , P0TM for more details.
P1RM	5:4	rw	Port 1 Receive Mirror Option See register 0136 _H , P0RM for more detail.
P0TM	3:2	rw	Port 0 Transmit Mirror Option 00 _B , Does not be mirrored 01 _B , The traffic transmitted from Port 0 is mirrored 10 _B , The traffic with DA = assign address transmitted from Port 0 is mirrored 11 _B , The traffic with SA = assign address transmitted from Port 0 is mirrored

Registers Description

Field	Bits	Type	Description
PORM	1:0	rw	Port 0 Receive Mirror Option 00 _B , Does not be mirrored 01 _B , The traffic received on Port 0 is mirrored 10 _B , The traffic with DA = assign address received on Port 0 is mirrored 11 _B , The traffic with SA = assign address received on Port 0 is mirrored

Mirror Register 1

MIRR1 **Offset**
Mirror Register 1 **Reset Value**
137_H **0000_H**

15	14	13	12	11	10	9	8	7	6	5	4	3	2	1	0
ME	MCA	MRA	MPA	MLA	MSA	Res	ETUP	P5TM	P5RM	P4TM	P4RM				
rw	rw	rw	rw	rw	rw	rw	rw	rw	rw	rw	rw	rw	rw	rw	rw

Field	Bits	Type	Description
ME	15	rw	Mirror Enable 0 _B , Disable 1 _B , Enable
MCA	14	rw	Mirror CRC Also 0 _B , Does not mirror 1 _B , Mirrors
MRA	13	rw	Mirror RXER Also 0 _B , Does not mirror 1 _B , Mirrors
MPA	12	rw	Mirror PAUSE Also 0 _B , Does not mirror 1 _B , Mirrors
MLA	11	rw	Mirror Long Also 0 _B , Does not mirror 1 _B , Mirrors
MSA	10	rw	Mirror Short Also 0 _B , Does not mirror 1 _B , Mirrors
Res	9	rw	Reserved
ETUP	8	rw	Enable Transmit Unmonitored Packet to the Mirror Port 0 _B , Mirror port only mirrors the mirrored packets 1 _B , Mirror port also receives packets that are not mirrored but their output ports also contain the mirror port
P5TM	7:6	rw	Port 5 Transmit Mirror Option See register 0136 _H , P0TM for more details.
P5RM	5:4	rw	Port 5 Receive Mirror Option See register 0136 _H , P0RM for more details.

Registers Description

Field	Bits	Type	Description
P4TM	3:2	rw	Port 4 Transmit Mirror Option See register 0136 _H , POTM for more details.
P4RM	1:0	rw	Port 4 Receive Mirror Option See register 0136 _H , PORM for more details.

Security Violation Port

SVP	Offset	Reset Value
Security Violation Port	138_H	0000_H

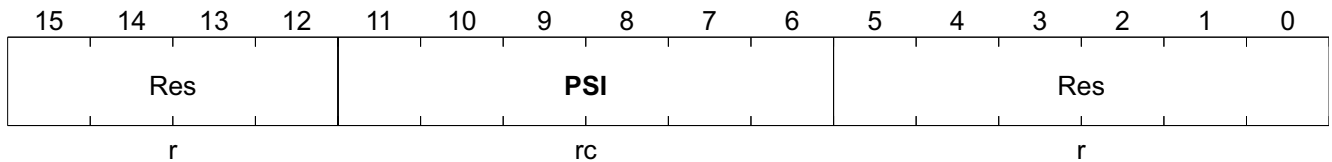

Field	Bits	Type	Description
Res	15:12	r	Reserved
PSI	11:6	rc	Port Source Intrusion 0 _B , Source Intrusion did not happen 1 _B , Source Intrusion happened
Res	5:0	r	Reserved

Security Status 0

SS0	Offset	Reset Value
Security Status 0	139_H	0000_H

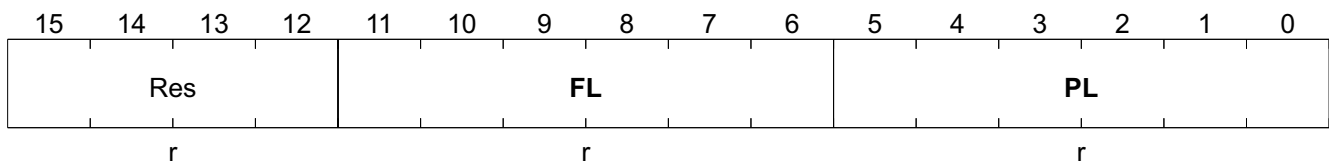

Field	Bits	Type	Description
Res	15:12	r	Reserved
FL	11:6	r	First Lock 0 _B , Port did not lock the address 1 _B , Port locked the address
PL	5:0	r	Port Locked 0 _B , Port did not close 1 _B , Port closed because of source violation

Security Status 1

SS1 **Offset**
Security Status 1 **13A_H** **Reset Value**
0000_H

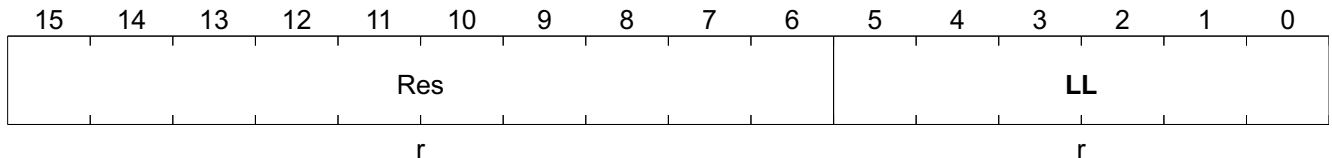

Field	Bits	Type	Description
Res	15:6	r	Reserved
LL	5:0	r	Link Lock 0 _B , Link Lock did not happen 1 _B , Link Lock happened

First Lock Address Search

FLAS **Offset**
First Lock Address Search **13B_H** **Reset Value**
0000_H

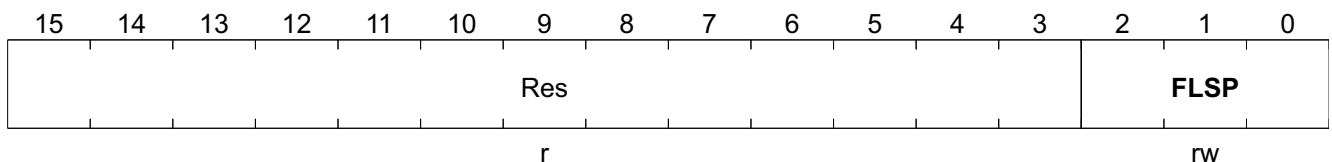

Field	Bits	Type	Description
Res	15:3	r	Reserved
FLSP	2:0	rw	First Lock Search Port Users could write this register to get the lock address and the lock FID (returned in the 13C _H , 13D _H , 13E _H , 13F _H) associated with the port. 000 _B , Search the address and FID locked on the port 0 001 _B , Search the address and FID locked on the port 1 010 _B , Search the address and FID locked on the port 1 011 _B , Search the address and FID locked on the port 1 100 _B , Search the address and FID locked on the port 1 101 _B , Search the address and FID locked on the port 1

First Lock Address [15:0]

FLA1	Offset	Reset Value
First Lock Address [15:0]	13C _H	0000 _H

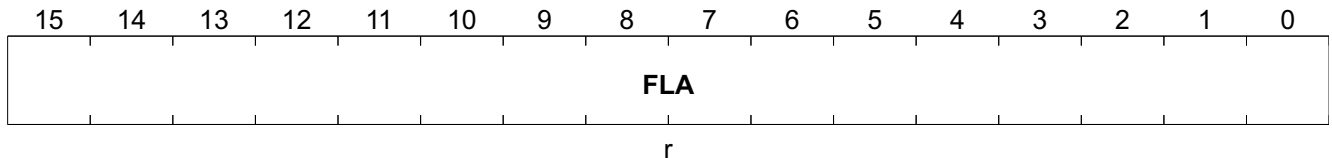

Field	Bits	Type	Description
FLA	15:0	r	First Lock Address [15:0]

First Lock Address [31:16]

FLA2	Offset	Reset Value
First Lock Address [31:16]	13D _H	0000 _H

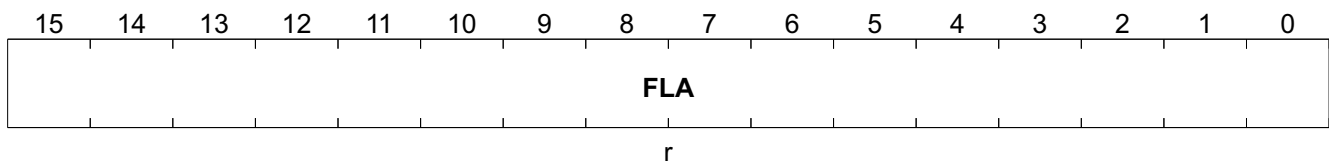

Field	Bits	Type	Description
FLA	15:0	r	First Lock Address [31:16]

First Lock Address [47:32]

FLA3	Offset	Reset Value
First Lock Address [47:32]	13E _H	0000 _H

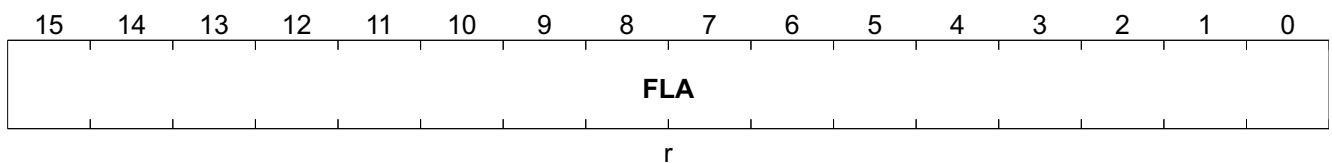

Field	Bits	Type	Description
FLA	15:0	r	First Lock Address [47:32]

First Lock FID

FLF **Offset**
First Lock FID **13F_H** **Reset Value**
0000_H

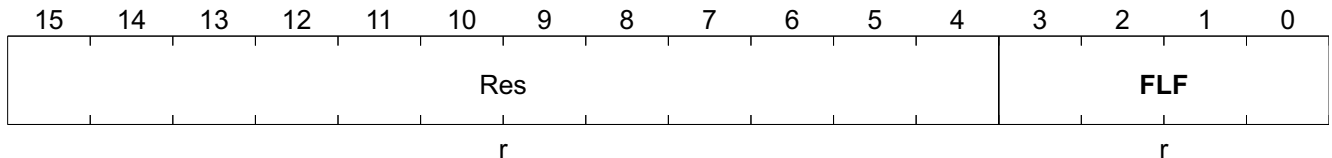

Field	Bits	Type	Description
Res	15:4	r	Reserved
FLF	3:0	r	First Lock FID

Counter Control Low Register

CCL **Offset**
Counter Control Low Register **140_H** **Reset Value**
0000_H

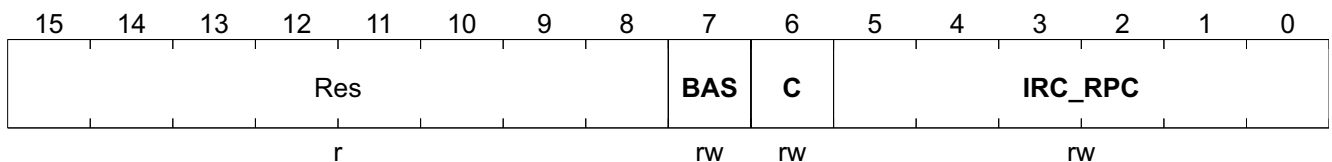

Field	Bits	Type	Description
Res	15:8	r	Reserved
BAS	7	rw	Busy/Access Start 0 _B , The counter control is free 1 _B , The counter control is busy, or users should write 1 _B into this bit to start the access when the engine is free
C	6	rw	Counter 0 _B , Indirect Read Counter 1 _B , Renew Port Counter
IRC_RPC	5:0	rw	Indirect Read Counter It means the counter address Renew Port Counter It means the counters on each port to renew

4.4 PHY Registers

PHY Control Register of Port 0

PHY_C0	Offset	Reset Value
PHY Control Register of Port 0	200 _H	3100 _H

15	14	13	12	11	10	9	8	7	6	5	4	3	2	1	0
RST	LPBK	SPEED_L*	ANEN	PDN	ISO	ANEN_RST	DPLX	COLT_ST	SPEED_M*	Res					
rw, sc	rw	rw	rw	rw	rw	rw, sc	rw	rw	ro						

Field	Bits	Type	Description
RST	15	rw, sc	<p>RESET</p> <p>Setting this bit initiates the software reset function that resets the selected port, except for the phase-locked loop circuit. It will re-latch in all hardware configuration pin values. The software reset process takes 25 μ s to complete. This bit, which is self-clearing, returns a value of 1 until the reset process is complete.</p> <p>0_B , Normal operation 1_B , PHY Reset</p>
LPBK	14	rw	<p>Loop Back Enable</p> <p>This bit controls the PHY loopback operation that isolates the network transmitter outputs (TXP and TXN) and routes the MII transmit data to the MII receive data path. This function should only be used when auto negotiation is disabled (bit 12 = 0). The specific PHY (10Base-T or 100Base-X) used for this operation is determined by bits 12 and 13 of this register.</p> <p>0_B , Disable Loopback mode 1_B , Enable loopback mode</p>
SPEED_LSB	13	rw	<p>Speed Selection LSB, 0.6, 0.13</p> <p>Link speed is selected by this bit or by auto negotiation if bit 12 of this register is set (in which case, the value of this bit is ignored). If it is fiber mode, 0.13 is always 1. Any write to this bit will have no effect.</p> <p>00_B , 10 Mbit/s 01_B , 100 Mbit/s 10_B , 1000 Mbit/s 11_B , Reserved</p>
ANEN	12	rw	<p>Auto Negotiation Enable</p> <p>This bit determines whether the link speed should be set up by the auto negotiation process or not. It is set at power up or reset if the RECANEN pin detects a logic 1 input level in Twisted-Pair Mode. If it is set when fiber mode is configured, any write to this bit will be ignored.</p> <p>0_B , Disable Auto negotiation process 1_B , Enable auto negotiation process</p>

Field	Bits	Type	Description
PDN	11	rw	Power Down Enable Setting this bit high puts the PHY into power down mode. During the power down mode, TXP/TXN and all LED outputs are tristated and the MII interfaces are isolated. 0 _B , Normal Operation 1 _B , Power Down
ISO	10	rw	Isolate PHY from Network Setting this control bit isolates the part from the MII, with the exception of the serial management interface. When this bit is asserted, the PHY does not respond to TXD, TXEN and TXER inputs, and it presents a high impedance on its TXC, RXC, CRSDV, RXER, RXD , COL and CRS outputs. 0 _B , Normal Operation 1 _B , Isolate PHY from MII
ANEN_RST	9	rw, sc	Restart Auto Negotiation Setting this bit while auto negotiation is enabled it forces a new auto negotiation process to start. This bit is self-clearing and returns to 0 after the auto negotiation process has commenced. 0 _B , Normal Operation 1 _B , Restart Auto Negotiation Process
DPLX	8	rw	Duplex Mode If auto negotiation is disabled, this bit determines the duplex mode for the link. 0 _B , Half Duplex mode 1 _B , Full Duplex mode
COLTST	7	rw	Collision Test When set, this bit will cause the COL signal of MII interface to be asserted in response to the assertion of TXEN. 0 _B , Disable COL signal test 1 _B , Enable COL signal test
SPEED_MSB	6	ro	Speed Selection MSB Set to 0 all the time to indicate that the PHY does not support 1000 Mbit/s function.

Similar Registers

All PHY_Cx registers have the same structure and characteristics, see [PHY_C0](#).
 The offset addresses of the other PHY_Cx registers are listed in [Table 65](#).

Table 65 PHY_Cx Registers

Register Short Name	Register Long Name	Offset Address	Page Number
PHY_C1	PHY Control Register of Port 1	220 _H	
PHY_C2	PHY Control Register of Port 2	240 _H	
PHY_C3	PHY Control Register of Port 3	260 _H	
PHY_C4	PHY Control Register of Port 4	280 _H	

PHY Status Register of Port 0

PHY_S0 Offset Reset Value
PHY Status Register of Port 0 201_H 7849_H

15	14	13	12	11	10	9	8	7	6	5	4	3	2	1	0
CAP_T4	CAP_TXF	CAP_TXH	CAP_TF	CAP_TH	CAP_T2	Res			CAP_SUPR	AN_COMP	REM_FLT	CAP_ANEG	LINK	JAB	EXTR EG
ro	ro	ro	ro	ro	ro				ro	ro	ro	ro	ro	ro	ro

Field	Bits	Type	Description
CAP_T4	15	ro	100Base-T4 Capable Set to 0 all the time to indicate that the PHY does not support 100Base-T4
CAP_TXF	14	ro	100Base-X Full Duplex Capable Set to 1 all the time to indicate that the PHY does support Full Duplex mode
CAP_TXH	13	ro	100Base-X Half Duplex Capable Set to 1 all the time to indicate that the PHY does support Half Duplex mode
CAP_TF	12	ro	10M Full Duplex Capable TP : Set to 1 all the time to indicate that the PHY does support 10M Full Duplex mode FX : Set to 0 all the time to indicate that the PHY does not support 10M Full Duplex mode
CAP_TH	11	ro	10M Half Duplex Capable TP : Set to 1 all the time to indicate that the PHY does support 10M Half Duplex mode FX : Set to 0 all the time to indicate that the PHY does not support 10M Half Duplex mode
CAP_T2	10	ro	100Base-T2 Capable Set to 0 all the time to indicate that the PHY does not support 100Base-T2
CAP_SUPR	6	ro	MF Preamble Suppression Capable This bit is hardwired to 1 indicating that the PHY accepts management frame without preamble. Minimum 32 preamble bits are required following power-on or hardware reset. One idle bit is required between any two management transactions as per IEEE 802.3u specification.
AN_COMP	5	ro	Auto Negotiation Complete If auto negotiation is enabled, this bit indicates whether the auto negotiation process has been completed or not. Set to 0 all the time when Fiber Mode is selected. 0 _B , Auto Negotiation process not completed 1 _B , Auto Negotiation process completed

Registers Description

Field	Bits	Type	Description
REM_FLT	4	ro	<p>Remote Fault Detect</p> <p>This bit is latched to 1 if the RF bit in the auto negotiation link partner ability register (bit 13, register address 05_H) is set or the receive channel meets the far end fault indication function criteria. It is unlatched when this register is read.</p> <p>0_B , Remote Fault not detected 1_B , Remote Fault detected</p>
CAP_ANEG	3	ro	<p>Auto Negotiation Ability</p> <p>TP : This bit is set to 1 all the time, indicating that PHY is capable of auto negotiation. FX : This bit is set to 0 all the time, indicating that PHY is not capable of auto negotiation in Fiber Mode.</p> <p>0_B , Not capable of auto negotiation 1_B , Capable of auto negotiation</p>
LINK	2	ro	<p>Link Status</p> <p>This bit reflects the current state of the link – test-fail state machine. Loss of a valid link causes a 0 latched into this bit. It remains 0 until this register is read by the serial management interface. Whenever Linkup, this bit should be read twice to get link up status</p> <p>0_B , Link is down 1_B , Link is up</p>
JAB	1	ro	<p>Jabber Detect</p> <p>0_B , Jabber condition not detected 1_B , Jabber condition detected</p>
EXTREG	0	ro	<p>Extended Capability</p> <p>This bit defaults to 1, indicating that the PHY implements extended registers.</p> <p>0_B , No extended register set 1_B , Extended register set</p>

Similar Registers

All PHY_Sx registers have the same structure and characteristics, see [PHY_S0](#).
The offset addresses of the other PHY_Sx registers are listed in [Table 66](#).

Table 66 PHY_Sx Registers

Register Short Name	Register Long Name	Offset Address	Page Number
PHY_S1	PHY Status Register of Port 1	221 _H	
PHY_S2	PHY Status Register of Port 2	241 _H	
PHY_S3	PHY Status Register of Port 3	261 _H	
PHY_S4	PHY Status Register of Port 4	281 _H	

PHY Identifier Register of Port 0 (A)

PHY_I0_A	Offset	Reset Value
PHY Identifier Register of Port 0 (A)	202 _H	0302 _H

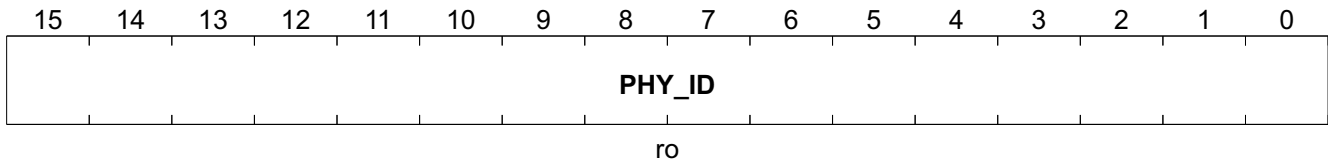

Field	Bits	Type	Description
PHY_ID	15:0	ro	IEEE Address

Similar Registers

All PHY_Ix_A registers have the same structure and characteristics, see [PHY_I0_A](#).
The offset addresses of the other PHY_Ix_A registers are listed in [Table 67](#).

Table 67 PHY_Ix_A Registers

Register Short Name	Register Long Name	Offset Address	Page Number
PHY_I1_A	PHY Identifier Register of Port 1 (A)	222 _H	
PHY_I2_A	PHY Identifier Register of Port 2 (A)	242 _H	
PHY_I3_A	PHY Identifier Register of Port 3 (A)	262 _H	
PHY_I4_A	PHY Identifier Register of Port 4 (A)	282 _H	

PHY Identifier Register of Port 0 (B)

PHY_I0_B	Offset	Reset Value
PHY Identifier Register of Port 0 (B)	203 _H	6071 _H

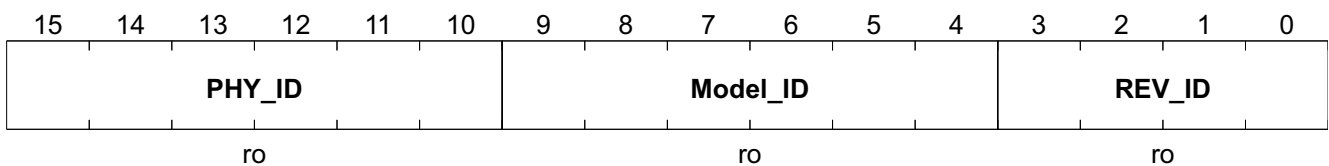

Field	Bits	Type	Description
PHY_ID	15:10	ro	IEEE Address
Model_ID	9:4	ro	IEEE Model No.
REV_ID	3:0	ro	IEEE Revision No.

Similar Registers

All PHY_Ix_B registers have the same structure and characteristics, see [PHY_I0_B](#).
The offset addresses of the other PHY_Ix_B registers are listed in [Table 68](#).

Table 68 PHY_Ix_B Registers

Register Short Name	Register Long Name	Offset Address	Page Number
PHY_I1_B	PHY Identifier Register of Port 1 (B)	223 _H	
PHY_I2_B	PHY Identifier Register of Port 2 (B)	243 _H	

Table 68 PHY_Ix_B Registers (cont'd)

Register Short Name	Register Long Name	Offset Address	Page Number
PHY_I3_B	PHY Identifier Register of Port 3 (B)	263 _H	
PHY_I4_B	PHY Identifier Register of Port 4 (B)	283 _H	

Auto Negotiation Advertisement Register of Port 0

ANAP0	Offset	Reset Value
Auto Negotiation Advertisement Register of Port 0	204_H	05E1_H

15	14	13	12	11	10	9	8	7	6	5	4	3	2	1	0
NP	Res	RF	Res	ASM DIR	PAUSE	T4	TX_FDX	TX_HDX	10_FDX	10_HDX				SF	
ro		ro		rw	rw	ro	rw	rw	rw	rw				ro	

Field	Bits	Type	Description
NP	15	ro	Next Page This bit defaults to 1, indicating that PHY is next page capable
RF	13	ro	Remote Fault This bit is written by serial management interface for the purpose of communicating the remote fault condition to the auto negotiation link partner. 0 _B , No remote fault has been detected 1 _B , Remote Fault has been detected
ASM_DIR	11	rw	Asymmetric Pause Direction Bit[11:10] Capability 00 _B , No Pause 01 _B , Symmetric PAUSE 10 _B , Asymmetric PAUSE toward Link Partner 11 _B , Both Symmetric PAUSE and Asymmetric PAUSE toward local device
PAUSE	10	rw	Pause Operation for Full Duplex Value on PAUREC will be stored in this bit during power on reset.
T4	9	ro	Technology Ability for 100Base-T4 Defaults to 0.
TX_FDX	8	rw	100Base-TX Full Duplex 0 _B , Not capable of 100M Full duplex operation 1 _B , Capable of 100M Full duplex operation
TX_HDX	7	rw	100Base-TX Half Duplex 0 _B , Not capable of 100M operation 1 _B , Capable of 100M operation
10_FDX	6	rw	10BASE-T Full Duplex 0 _B , Not capable of 10M full duplex operation 1 _B , Capable of 10M Full Duplex operation

Registers Description

Field	Bits	Type	Description
10_HDX	5	rw	10Base-T Half Duplex <i>Note: Bit 8:5 should be combined with REC100, RECFUL pin input to determine the finalized speed and duplex mode.</i> 0 _B , Not capable of 10M operation 1 _B , Capable of 10M operation
SF	4:0	ro	Selector Field These 5 bits are hardwired to 00001 _B , indicating that the PHY supports IEEE 802.3 CSMA/CD.

Similar Registers

All ANAPx registers have the same structure and characteristics, see [ANAP0](#).
The offset addresses of the other ANAPx registers are listed in [Table 69](#).

Table 69 ANAPx Registers

Register Short Name	Register Long Name	Offset Address	Page Number
ANAP1	Auto Negotiation Advertisement Register of Port 1	224 _H	
ANAP2	Auto Negotiation Advertisement Register of Port 2	244 _H	
ANAP3	Auto Negotiation Advertisement Register of Port 3	264 _H	
ANAP4	Auto Negotiation Advertisement Register of Port 4	284 _H	

Auto Negotiation Link Partner Ability Register of Port 0

ANLPA0	Offset	Reset Value
Auto Negotiation Link Partner Ability Register of Port 0	205_H	01E1_H

15	14	13	12	11	10	9	8	7	6	5	4	3	2	1	0
NPAGE	ACK	RF	Res	LP_DIR	LP_PAUSE	LP_T4	LP_FD	LP_HD	LP_F10	LP_H10				SF	
ro	ro	ro		ro	ro	ro	ro	ro	ro	ro				ro	

Field	Bits	Type	Description
NPAGE	15	ro	Next Page 0 _B , Not capable of next page function 1 _B , Capable of next page function
ACK	14	ro	Acknowledge 0 _B , Not acknowledged 1 _B , Link Partner acknowledges reception of the ability data word
RF	13	ro	Remote Fault 0 _B , No remote fault has been detected 1 _B , Remote Fault has been detected
LP_DIR	11	ro	Link Partner Asymmetric Pause Direction

Field	Bits	Type	Description
PFAULT	4	ro, lh	Parallel Detection Fault 0 _B , No Fault has been detected 1 _B , Fault has been detected
LPNPABLE	3	ro	Link Partner Next Page Able 0 _B , Link Partner is not next page capable 1 _B , Link Partner is next page capable
NPABLE	2	ro	Next Page Able Defaults to 0, indicating PHY is not capable of next page.
PGRCV	1	ro	Page Received 0 _B , No new page has been received 1 _B , A new page has been received
LPANABLE	0	ro	Link Partner Auto Negotiation Able 0 _B , Link Partner is not auto negotiable 1 _B , Link Partner is auto negotiable

Similar Registers

All ANEx registers have the same structure and characteristics, see [ANE0](#).
The offset addresses of the other ANEx registers are listed in [Table 71](#).

Table 71 ANEx Registers

Register Short Name	Register Long Name	Offset Address	Page Number
ANE1	Auto Negotiation Expansion Register of Port 1	226 _H	
ANE2	Auto Negotiation Expansion Register of Port 2	246 _H	
ANE3	Auto Negotiation Expansion Register of Port 3	266 _H	
ANE4	Auto Negotiation Expansion Register of Port 4	286 _H	

Next Page Transmit Register of Port 0

NPT0 **Offset**
Next Page Transmit Register of Port 0 **207_H** **Reset Value**
2001_H

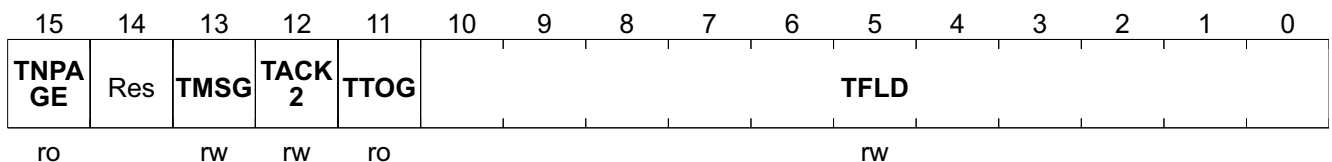

Field	Bits	Type	Description
TNPAGE	15	ro	Transmit Next Page Transmit Code Word Bit 15
TMSG	13	rw	Transmit Message Page Transmit Code Word Bit 13

Registers Description

Field	Bits	Type	Description
TACK2	12	rw	Transmit Acknowledge 2 Transmit Code Word Bit 12
TTOG	11	ro	Transmit Toggle Transmit Code Word Bit 11
TFLD	10:0	rw	Transmit Message Field Transmit Code Word Bit 10..0

Similar Registers

All NPTx registers have the same structure and characteristics, see [NPT0](#).
The offset addresses of the other NPTx registers are listed in [Table 72](#).

Table 72 NPTx Registers

Register Short Name	Register Long Name	Offset Address	Page Number
NPT1	Next Page Transmit Register of Port 1	227 _H	
NPT2	Next Page Transmit Register of Port 2	247 _H	
NPT3	Next Page Transmit Register of Port 3	267 _H	
NPT4	Next Page Transmit Register of Port 4	287 _H	

Link Partner Next Page Register of Port 0

LPNP0 **Offset**
Link Partner Next Page Register of Port 0 **208_H** **Reset Value**
0000_H

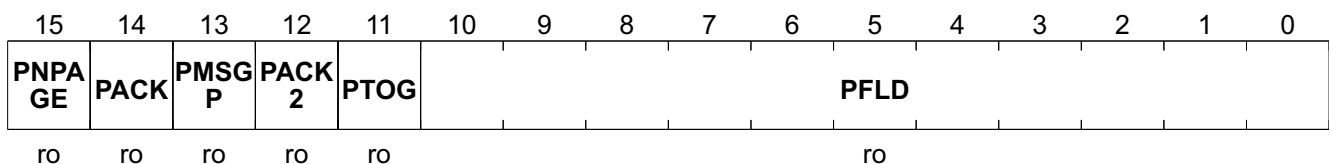

Field	Bits	Type	Description
PNPAGE	15	ro	Link Partner Next Page Receives Code Word Bit 15
PACK	14	ro	Link Partner Acknowledge Receives Code Word Bit 14
PMSGP	13	ro	Link Partner Message Page Receives Code Word Bit 13
PACK2	12	ro	Link Partner Acknowledge 2 Receives Code Word Bit 12
PTOG	11	ro	Link Partner Toggle Receives Code Word Bit 11
PFLD	10:0	ro	Link Partner Message Field Receives Code Word Bit 11

Similar Registers

All LPNPx registers have the same structure and characteristics, see [LPNP0](#).
The offset addresses of the other LPNPx registers are listed in [Table 73](#).

Table 73 LPNPx Registers

Register Short Name	Register Long Name	Offset Address	Page Number
LPNP1	Link Partner Next Page Register of Port 1	228 _H	
LPNP2	Link Partner Next Page Register of Port 2	248 _H	
LPNP3	Link Partner Next Page Register of Port 3	268 _H	
LPNP4	Link Partner Next Page Register of Port 4	288 _H	

5 Electrical Specification

5.1 TX/FX Interface

5.1.1 TP Interface

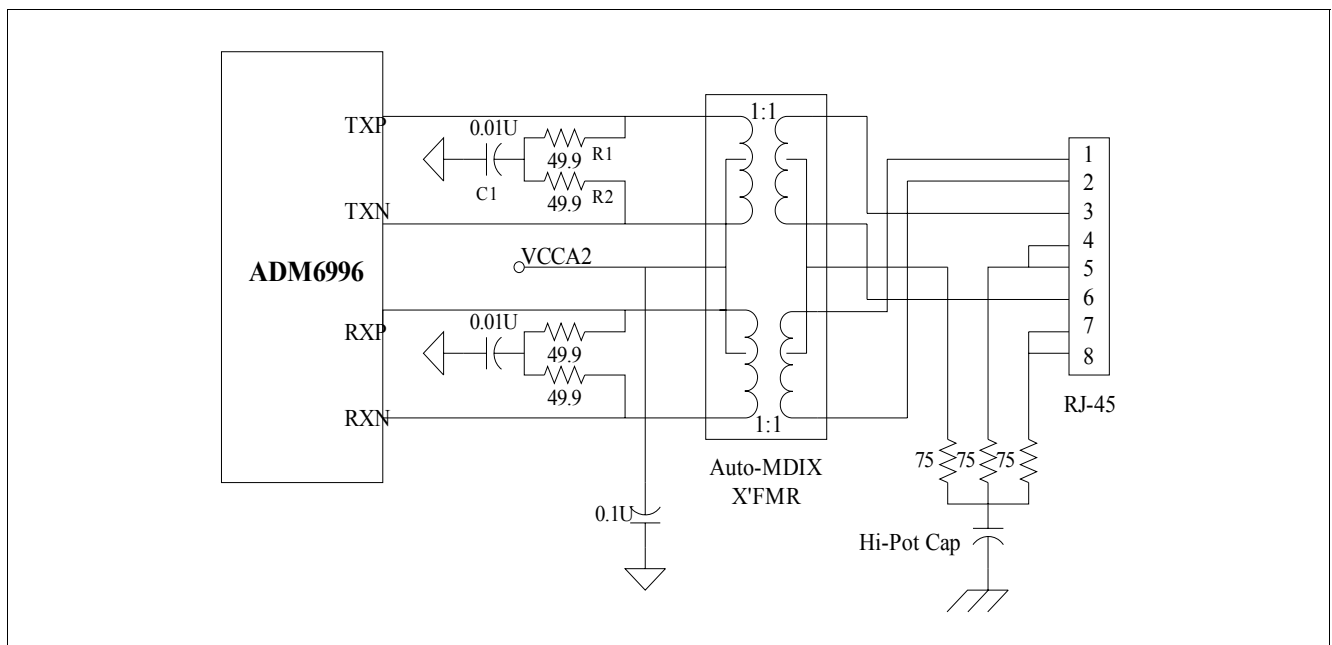

Figure 18 TP Interface

Transformer requirements:

- TX/RX rate 1:1
- TX/RX central tap connect together to VCCA2

Users can change the TX/RX pin for easy layout but do not change the polarity. Samurai-6M/6MX (ADM6996M/MX) supports auto polarity on the receiving side.

5.1.2 FX Interface

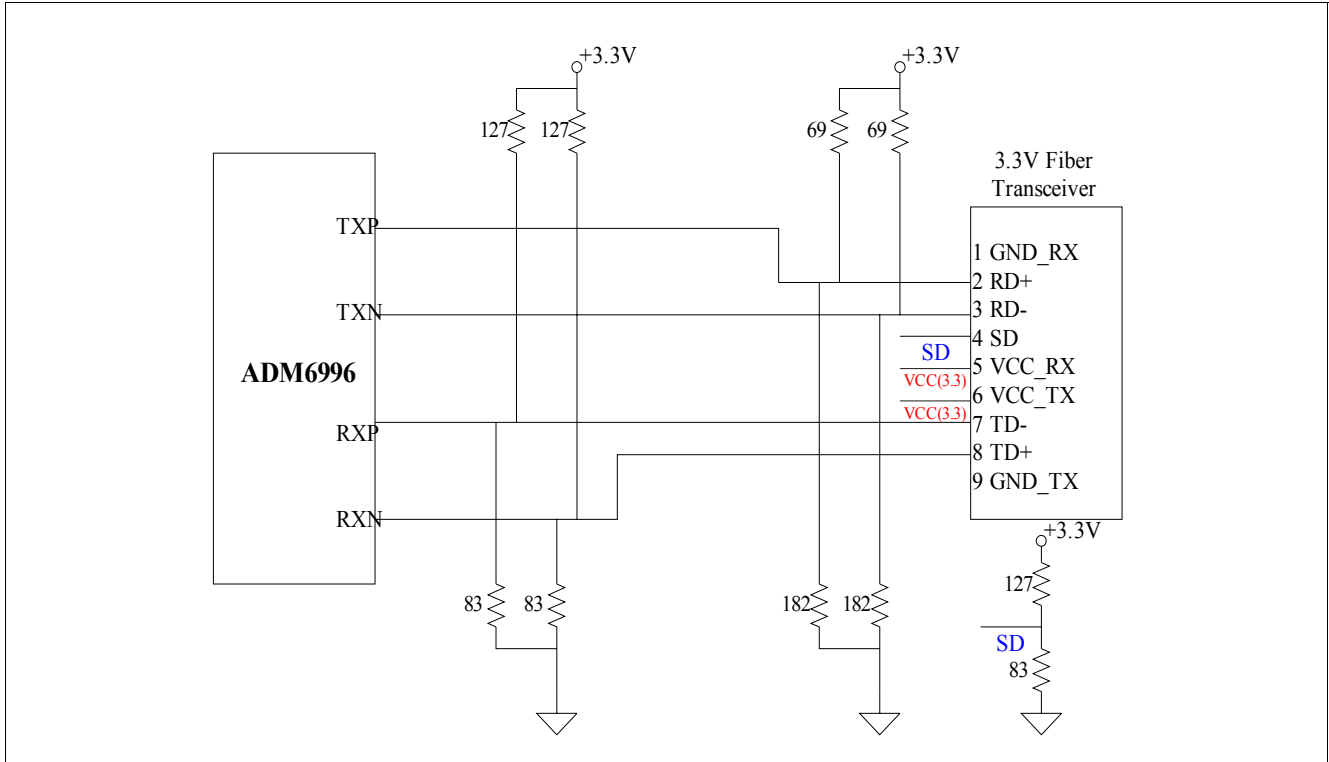

Figure 19 FX Interface

5.2 DC Characterization

Table 74 Power Consumption

Parameter	Symbol	Values			Unit	Note / Test Condition
		Min.	Typ.	Max.		
Power consumption when all twisted pair ports are linked at 100 Mbit/s.	P_{100M_5TP}	—	980	—	mW	Under EEPROM Register 29 _H = C000 _H , and 30 _H = 985 _H
Power consumption when all twisted pair ports are linked at 10 Mbit/s (include transformer).	P_{10M_5TP}	—	1450	—	mW	Under EEPROM Register 29 _H = C000 _H , and 30 _H = 985 _H
Power consumption when all twisted pair ports are disconnected.	P_{DIS_5TP}	—	500	—	mW	Under EEPROM Register 29 _H = C000 _H , and 30 _H = 985 _H

Table 75 Absolute Maximum Ratings

Parameter	Symbol	Values			Unit	Note / Test Condition
		Min.	Typ.	Max.		
3.3 V Power Supply for I/O pad	V_{CC30}	2.97	3.3	3.63	V	–
3.3 V Power Supply for bias circuit	V_{CCBS}	2.97	3.3	3.63	V	–
3.3 V Power Supply for A/D converter	V_{CCAD}	2.97	3.3	3.63	V	–
1.8 V Power Supply for line driver	V_{CCA2}	1.62	1.8	1.98	V	–
1.8 V Power Supply for PLL	V_{CCPLL}	1.62	1.8	1.98	V	–
1.8 V Power Supply for Digital core	V_{CCIK}	1.62	1.8	1.98	V	–
Input Voltage	V_{IN}	-0.3	–	$V_{CC30} + 0.3$	V	–
Output Voltage	V_{out}	-0.3	–	$V_{CC30} + 0.3$	V	–
Maximum current for 3.3 V power supply	$I_{3.3VMAX}$	–	–	100	mA	–
Maximum current for 1.8 V power supply (include transformer)	$I_{1.8VMAX}$	–	–	800	mA	–
Storage Temperature	T_{STG}	-55	–	155	°C	–
ESD Rating	ESD	1.0	–	–	kV	–

Attention: Stresses above the max. values listed here may cause permanent damage to the device. Exposure to absolute maximum rating conditions for extended periods may affect device reliability. Maximum ratings are absolute ratings; exceeding only one of these values may cause irreversible damage to the integrated circuit.

Table 76 Recommended Operating Conditions

Parameter	Symbol	Values			Unit	Note / Test Condition
		Min.	Typ.	Max.		
3.3 V Power Supply for I/O pad	V_{CC30}	3.135	3.3	3.465	V	–
3.3 V Power Supply for bias circuit	V_{CCBS}	3.135	3.3	3.465	V	–
3.3 V Power Supply for A/D converter	V_{CCAD}	3.135	3.3	3.465	V	–
1.8 V Power Supply for line driver	V_{CCA2}	1.71	1.8	1.89	V	–
1.8 V Power Supply for PLL	V_{CCPLL}	1.71	1.8	1.89	V	–
1.8 V Power Supply for Digital core	V_{CCIK}	1.71	1.8	1.89	V	–
Input Voltage	V_{in}	0	–	V_{CC}	V	–
Junction Operating Temperature	T_j	0	25	115	°C	–

Table 77 DC Electrical Characteristics for 3.3 V Operation¹⁾

Parameter	Symbol	Values			Unit	Note / Test Condition
		Min.	Typ.	Max.		
Input Low Voltage	V_{IL}	–	–	0.8	V	TTL
Input High Voltage	V_{IH}	2.0	–	–	V	TTL
Output Low Voltage	V_{OL}	–	–	0.4	V	TTL
Output High Voltage	V_{OH}	2.4	–	–	V	TTL
Input Pull-up/down Resistance	R_I	–	50	–	k Ω	$V_{IL} = 0\text{ V}$ or $V_{IH} = V_{CC30}$

1) Under $V_{CC30} = 2.97\text{V} \sim 3.63\text{V}$, $T_j = 0\text{ }^\circ\text{C} \sim 115\text{ }^\circ\text{C}$

5.3 AC Characterization

5.3.1 XTAL/OSC Timing

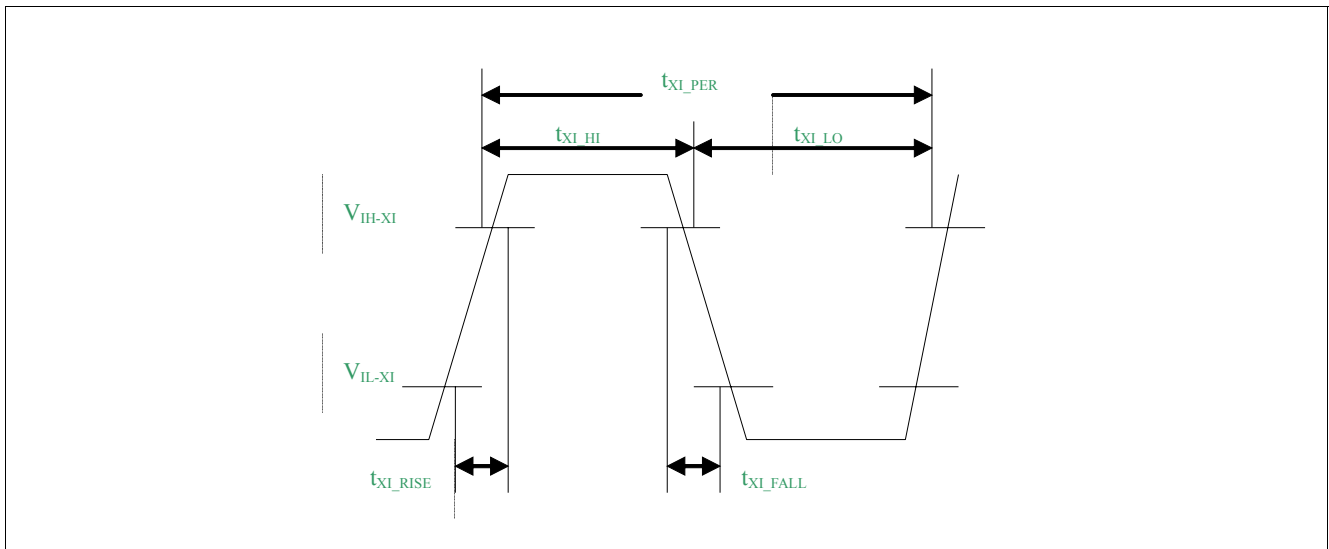

Figure 20 XTAL/OSC Timing

Table 78 XTAL/OSC Timing

Parameter	Symbol	Values			Unit	Note / Test Condition
		Min.	Typ.	Max.		
XI/OSCI Clock Period	t_{XI_PER}	40.0 - 50ppm	40.0	40.0 + 50ppm	ns	–
XI/OSCI Clock High	t_{XI_HI}	14	20.0	–	ns	–
XI/OSCI Clock Low	t_{XI_LO}	14	20.0	–	ns	–
XI/OSCI Clock Rise Time, V_{IL} (max) to V_{IH} (min.)	t_{XI_RISE}	–	–	4	ns	–
XI/OSCI Clock Fall Time, V_{IH} (min.) to V_{IL} (max)	t_{XI_FALL}	–	–	4	ns	–

5.3.2 Power On Reset

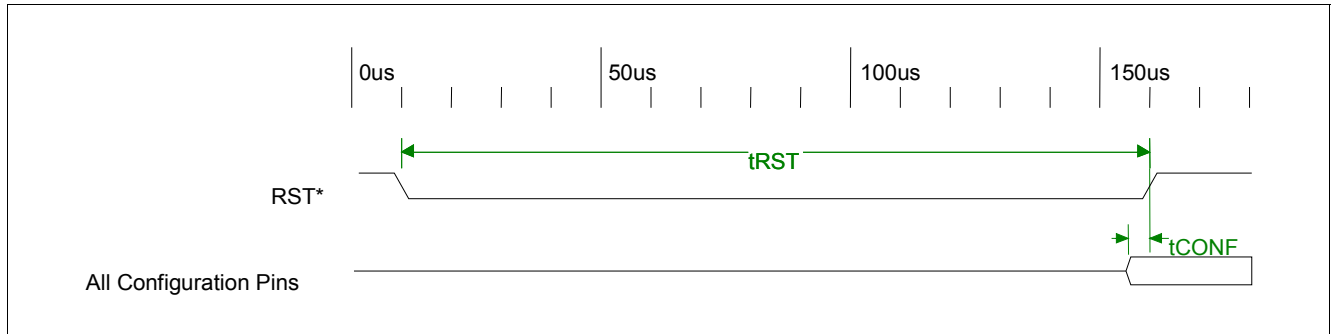

Figure 21 Power On Reset Timing

Table 79 Power On Reset Timing

Parameter	Symbol	Values			Unit	Note / Test Condition
		Min.	Typ.	Max.		
RST Low Period	t_{RST}	100	–	–	ms	–
Start of Idle Pulse Width	t_{CONF}	100	–	–	ns	–

5.3.3 EEPROM Interface Timing

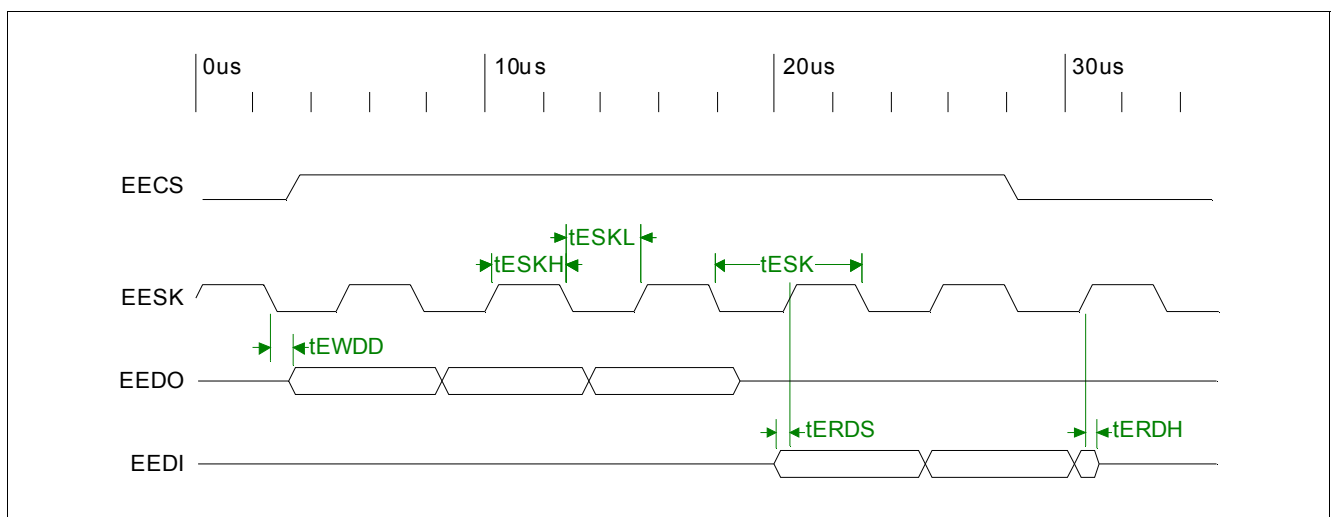

Figure 22 EEPROM Interface Timing

Table 80 EEPROM Interface Timing

Parameter	Symbol	Values			Unit	Note / Test Condition
		Min.	Typ.	Max.		
EESK Period	t_{ESK}	–	5120	–	ns	–
EESK Low Period	t_{ESKL}	2550	–	2570	ns	–
EESK High Period	t_{ESKH}	2550	–	2570	ns	–

Table 80 EEPROM Interface Timing (cont'd)

Parameter	Symbol	Values			Unit	Note / Test Condition
		Min.	Typ.	Max.		
EEDI to EESK Rising Setup Time	t_{ERDS}	10	–	–	ns	–
EEDI to EESK Rising Hold Time	t_{ERDH}	10	–	–	ns	–
EESK Falling to EEDO Output Delay Time	t_{EWDD}	–	–	20	ns	–

5.3.4 10Base-TX MII Input Timing

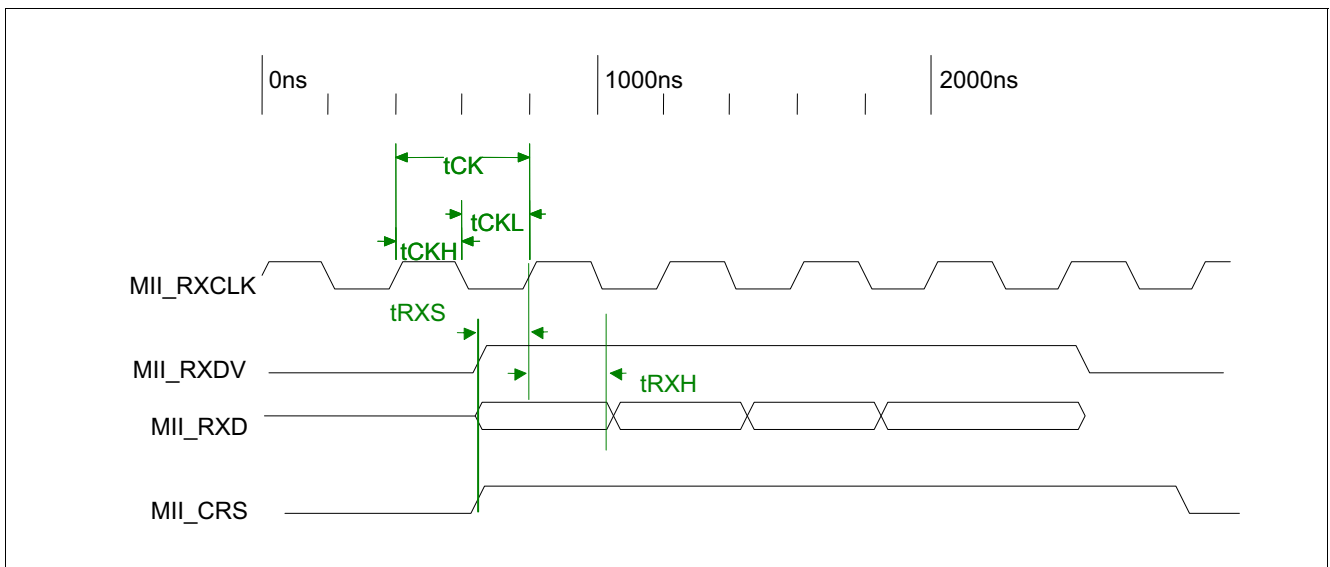

Figure 23 10Base-TX MII Input Timing

Table 81 10Base-TX MII Input Timing

Parameter	Symbol	Values			Unit	Note / Test Condition
		Min.	Typ.	Max.		
MII_RXCLK Period	t_{CK}	–	400	–	ns	–
MII_RXCLK Low Period	t_{CKL}	180	–	220	ns	–
MII_RXCLK High Period	t_{CKH}	180	–	220	ns	–
MII_CRD, MII_RXDV and MII_RXD to MII_RXCLK rising setup	t_{RXS}	10	–	–	ns	–
MII_CRD, MII_RXDV and MII_RXD to MII_RXCLK rising hold	t_{RXH}	10	–	–	ns	–

5.3.5 10Base-TX MII Output Timing

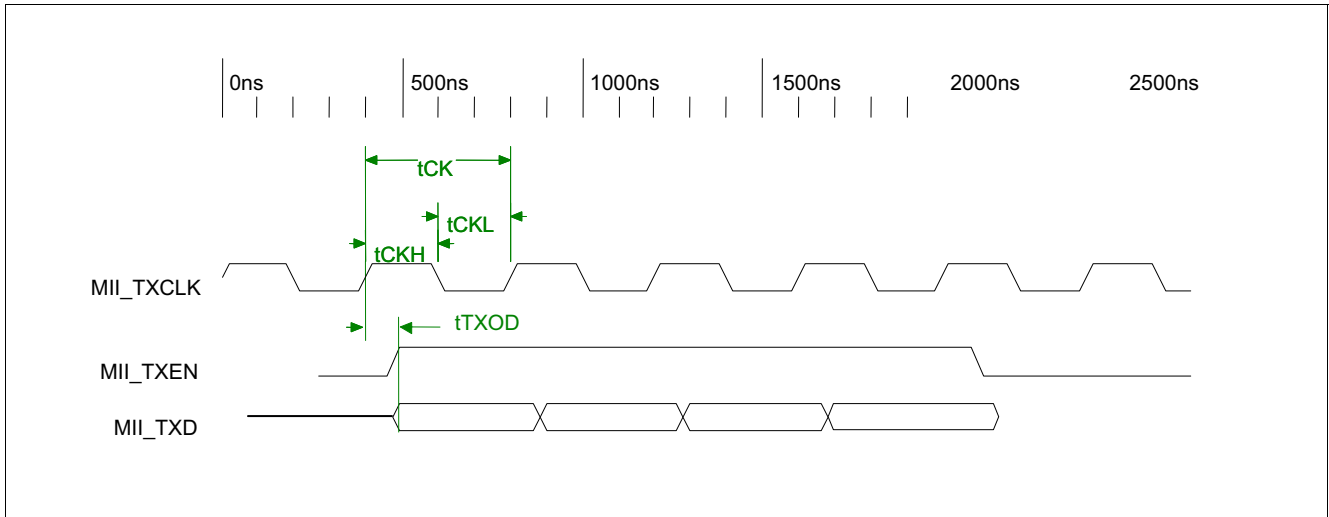

Figure 24 10Base-TX MII Output Timing

Table 82 10-Base-TX MII Output Timing

Parameter	Symbol	Values			Unit	Note / Test Condition
		Min.	Typ.	Max.		
MII_TXCLK Period	t_{CK}	–	400	–	ns	–
MII_TXCLK Low Period	t_{CKL}	180	–	220	ns	–
MII_TXCLK High Period	t_{CKH}	180	–	220	ns	–
MII_TXD, MII_TXEN to MII_TXCLK Rising Output Delay	t_{TXOD}	0	–	25	ns	–

5.3.6 100Base-TX MII Input Timing

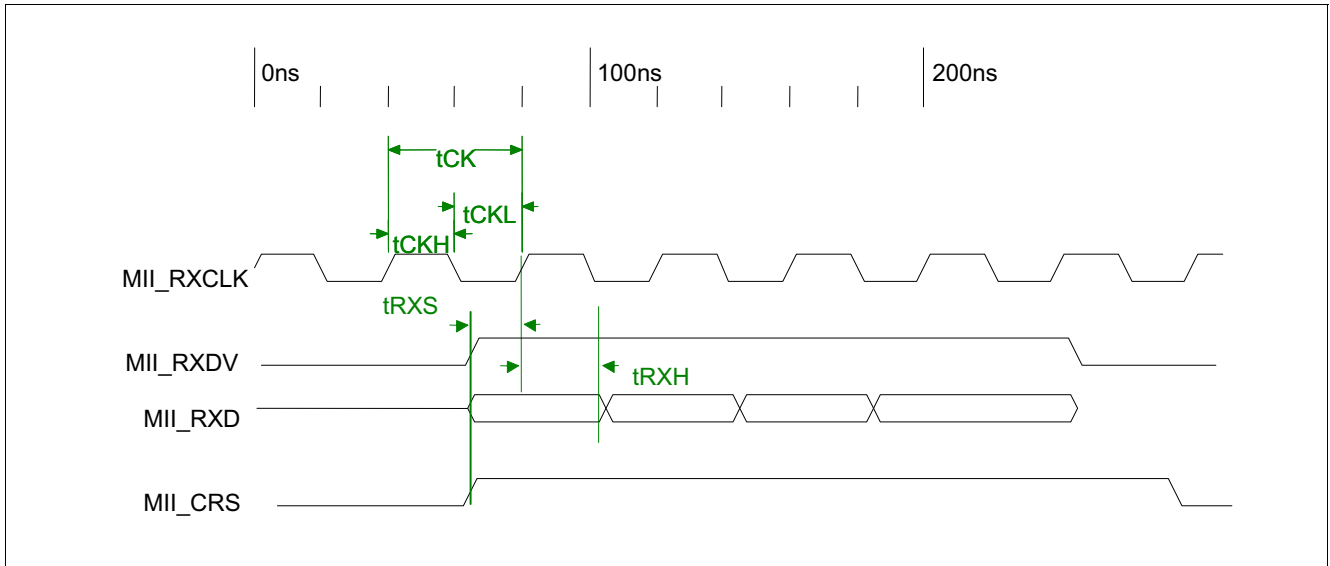

Figure 25 100Base-TX MII Input Timing

Table 83 100Base-TX MII Input Timing

Parameter	Symbol	Values			Unit	Note / Test Condition
		Min.	Typ.	Max.		
MII_RXCLK Period	t_{CK}	–	40	–	ns	–
MII_RXCLK Low Period	t_{CKL}	18	–	22	ns	–
MII_RXCLK High Period	t_{CKH}	18	–	22	ns	–
MII_CRS, MII_RXDV and MII_RXD to MII_RXCLK rising setup	t_{RXS}	10	–	–	ns	–
MII_CRS, MII_RXDV and MII_RXD to MII_RXCLK rising hold	t_{RXH}	10	–	–	ns	–

5.3.7 100Base-TX MII Output Timing

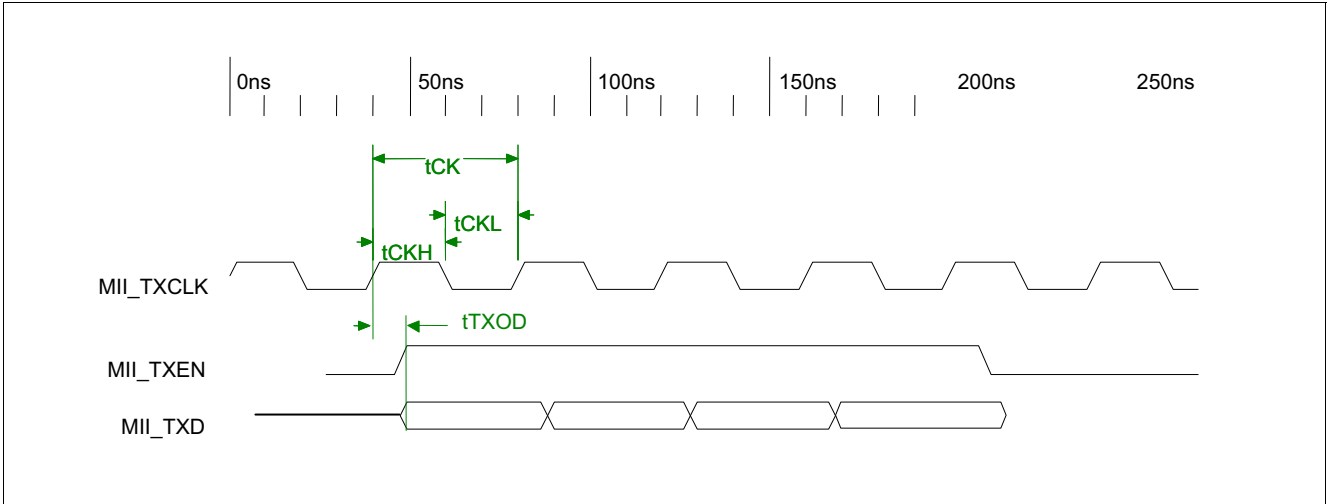

Figure 26 100Base-TX MII Output Timing

Table 84 100Base-TX MII Output Timing

Parameter	Symbol	Values			Unit	Note / Test Condition
		Min.	Typ.	Max.		
MII_TXCLK Period	t_{CK}	–	40	–	ns	–
MII_TXCLK Low Period	t_{CKL}	18	–	22	ns	–
MII_TXCLK High Period	t_{CKH}	18	–	22	ns	–
MII_TXD, MII_TXEN to MII_TXCLK Rising Output Delay	t_{TXOD}	0	–	25	ns	–

5.3.8 RMII REFCLK Input Timing

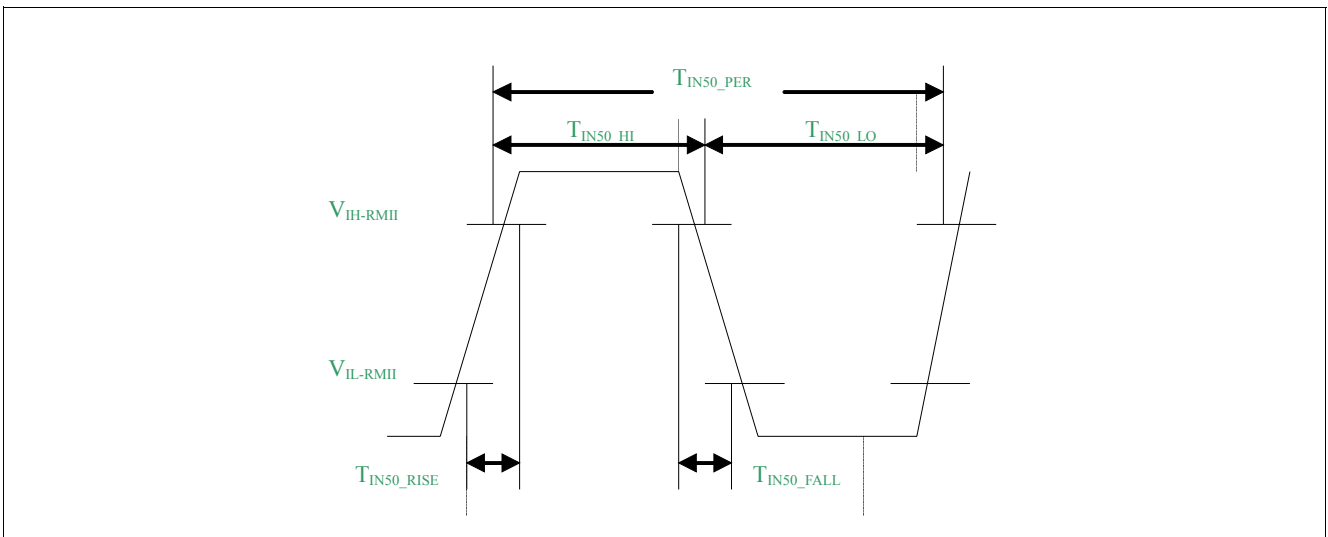

Figure 27 RMII REFCLK Input Timing

Table 85 RMI REFCLK Input Timing

Parameter	Symbol	Values			Unit	Note / Test Condition
		Min.	Typ.	Max.		
REFCLK Clock Period	t_{IN50_PER}	40.0 - 50ppm	40.0	40.0 + 50ppm	ns	–
REFCLK Clock High	t_{IN50_HI}	14	20.0	–	ns	–
REFCLK Clock Low	t_{IN50_LO}	14	20.0	–	ns	–
REFCLK Clock Rise Time, V_{IL} (max) to V_{IH} (min.)	t_{IN50_RISE}	–	–	2	ns	–
REFCLK Clock Fall Time, V_{IH} (min.) to V_{IL} (max)	t_{IN50_FALL}	–	–	2	ns	–

5.3.9 RMI REFCLK Output Timing

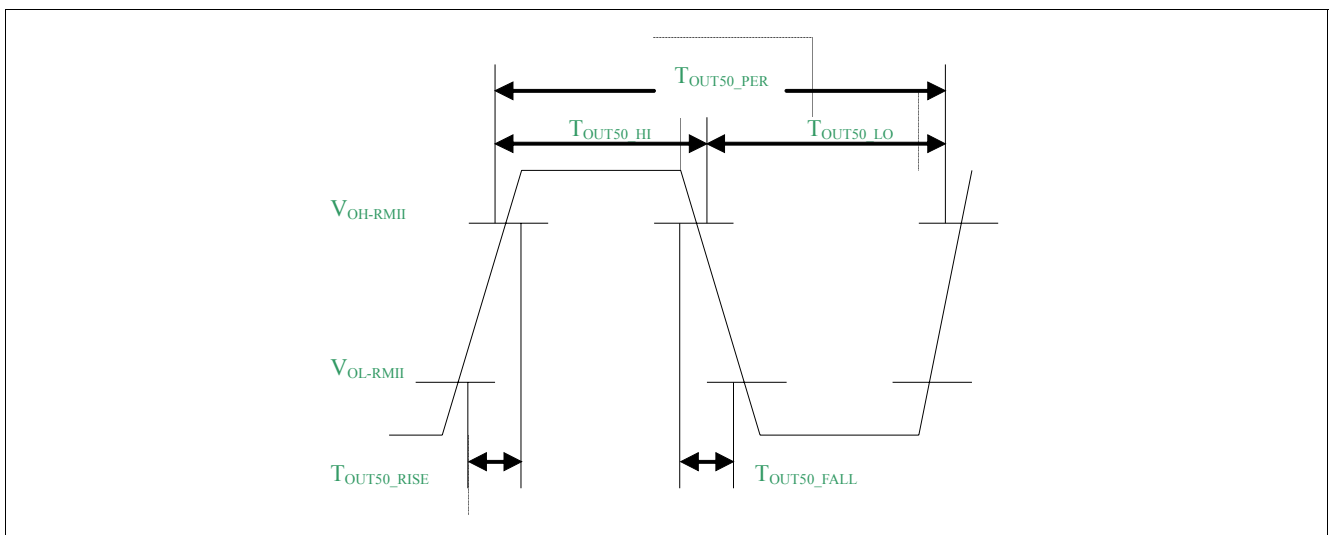

Figure 28 RMI REFCLK Output Timing

Table 86 RMI REFCLK Output Timing

Parameter	Symbol	Values			Unit	Note / Test Condition
		Min.	Typ.	Max.		
REFCLK Clock Period	t_{OUT50_PER}	40.0 - 50ppm	40.0	40.0 + 50ppm	ns	–
REFCLK Clock High	t_{OUT50_HI}	14	20.0	26	ns	–
REFCLK Clock Low	t_{OUT50_LO}	14	20.0	26	ns	–
REFCLK Clock Rise Time, V_{OL} (max) to V_{OH} (min.)	t_{OUT50_RISE}	–	–	2	ns	–
REFCLK Clock Fall Time, V_{OH} (min.) to V_{OL} (max)	t_{OUT50_FALL}	–	–	2	ns	–
REFCLK Clock Jittering (p-p)	t_{OUT50_JIT}	–	0.15	–	ns	–

5.3.10 Reduce MII Timing

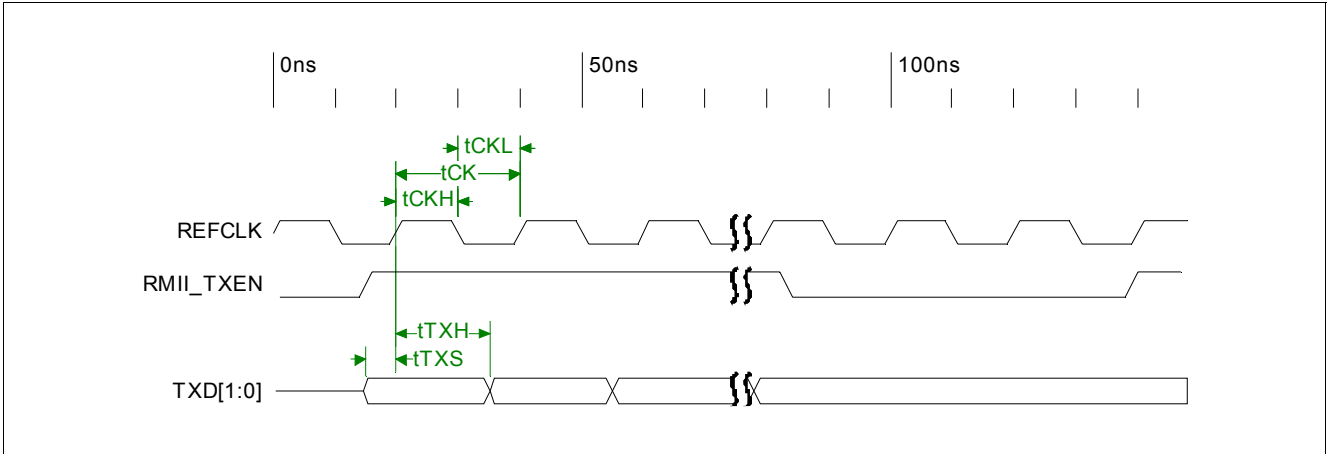

Figure 29 Reduce MII Timing (1 of 2)

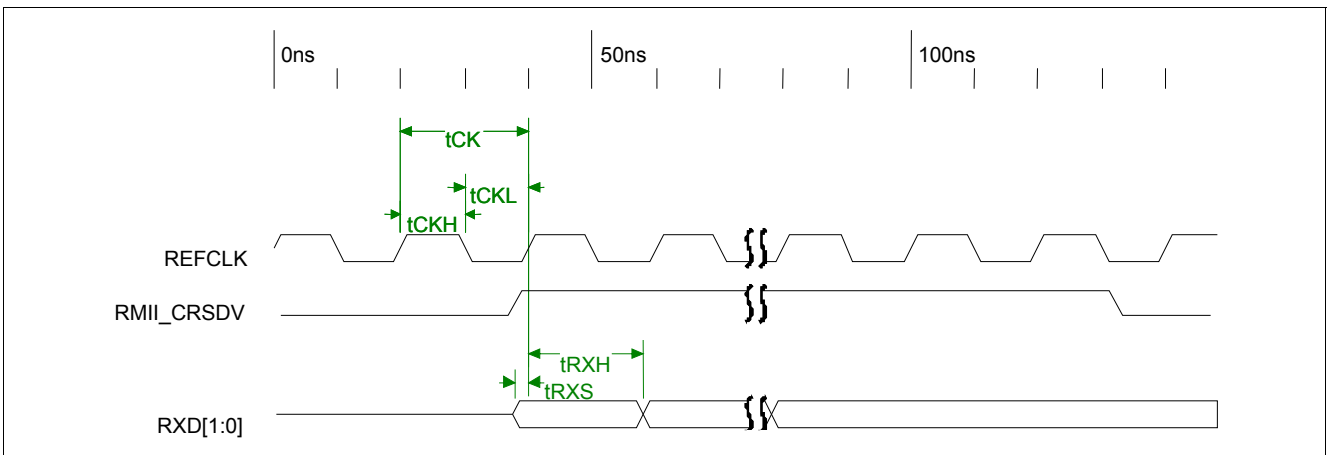

Figure 30 Reduce MII Timing (2 of 2)

Table 87 Reduce MII Timing

Parameter	Symbol	Values			Unit	Note / Test Condition
		Min.	Typ.	Max.		
RMII_REFCLK Period	t_{CK}	–	20	–	ns	–
RMII_REFCLK Low Period	t_{CKL}	–	10	–	ns	–
RMII_REFCLK High Period	t_{CKH}	–	10	–	ns	–
TXEN, TXD to REFCLK rising setup time	t_{TXS}	4	–	–	ns	–
TXE, TXD to REFCLK rising hold time	t_{TXH}	2	–	–	ns	–
CRSDV, RXD to REFCLK rising setup time	t_{RXS}	4	–	–	–	–
CRSDV, RXD to REFCLK rising hold time	t_{RXH}	2	–	–	–	–

5.3.11 GPSI (7-wire) Input Timing

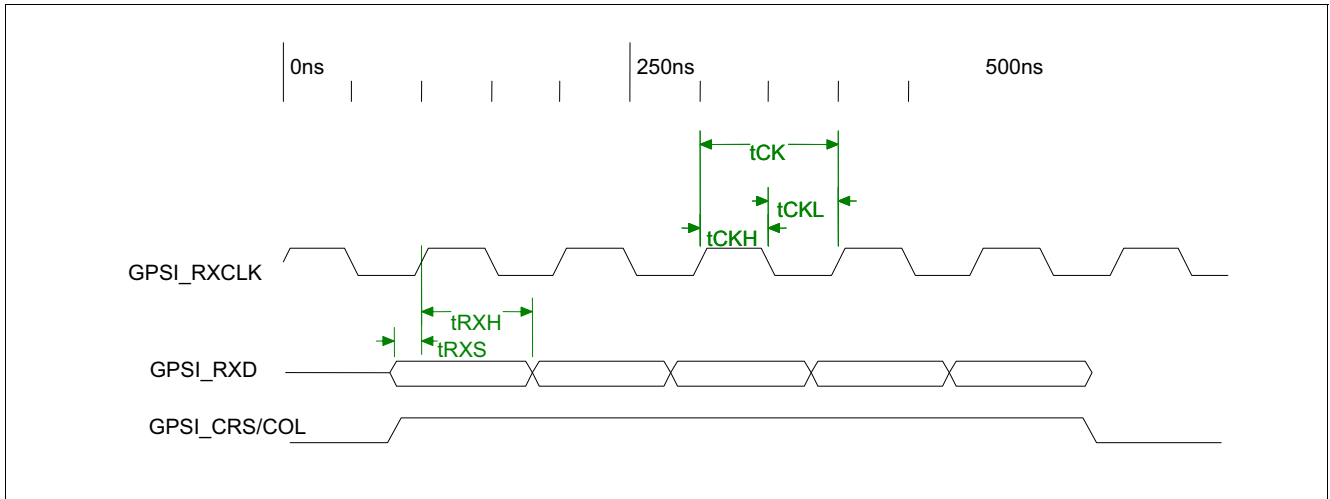

Figure 31 GPSI (7-wire) Input Timing

Table 88 GPSI (7-wire) Input Timing

Parameter	Symbol	Values			Unit	Note / Test Condition
		Min.	Typ.	Max.		
GPSI_RXCLK Period	t_{CK}	–	100	–	ns	–
GPSI_RXCLK Low Period	t_{CKL}	40	–	60	ns	–
GPSI_RXCLK High Period	t_{CKH}	40	–	60	ns	–
GPSI_RXD, GPSI_CRD/COL to GPSI_RXCLK Rising Setup Time	t_{RXS}	10	–	–	ns	–
GPSI_RXD, GPSI_CRD/COL to GPSI_RXCLK Rising HoldTime	t_{RXH}	10	–	–	ns	–

5.3.12 GPSI (7-wire) Output Timing

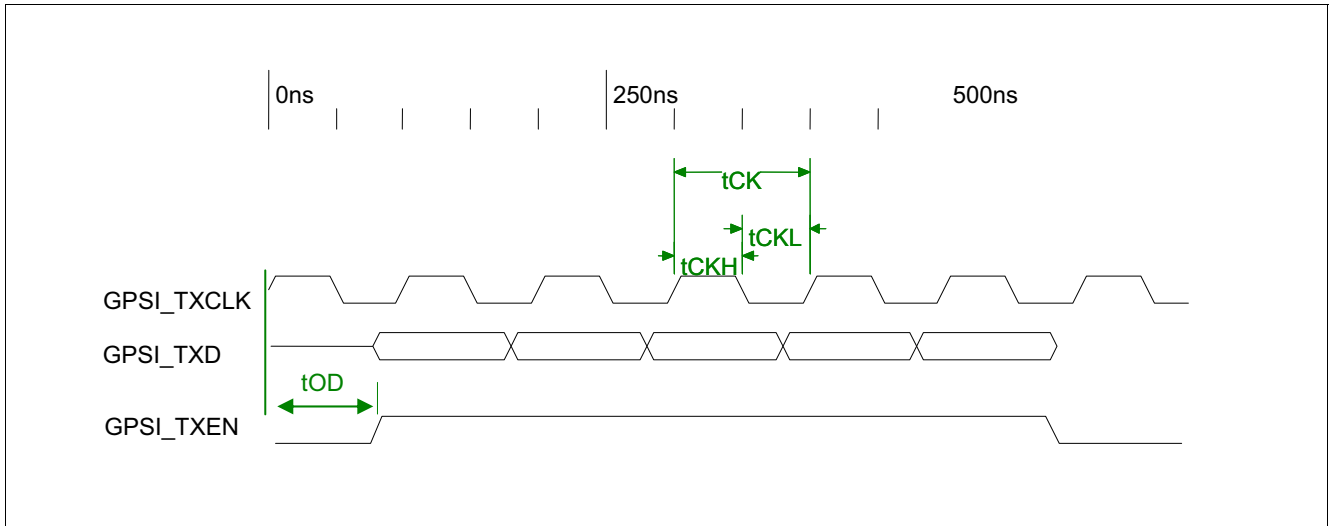

Figure 32 GPSI (7-wire) Output Timing

Table 89 GPSI (7-wire) Output Timing

Parameter	Symbol	Values			Unit	Note / Test Condition
		Min.	Typ.	Max.		
GPSI_TXCLK Period	t_{CK}	–	100	–	ns	–
GPSI_TXCLK Low Period	t_{CKL}	40	–	60	ns	–
GPSI_TXCLK High Period	t_{CKH}	40	–	60	ns	–
GPSI_TXCLK Rising to GPSI_TXEN/GPSI_TXD Output Delay	t_{OD}	50	–	70	ns	–

5.3.13 SDC/SDIO Timing

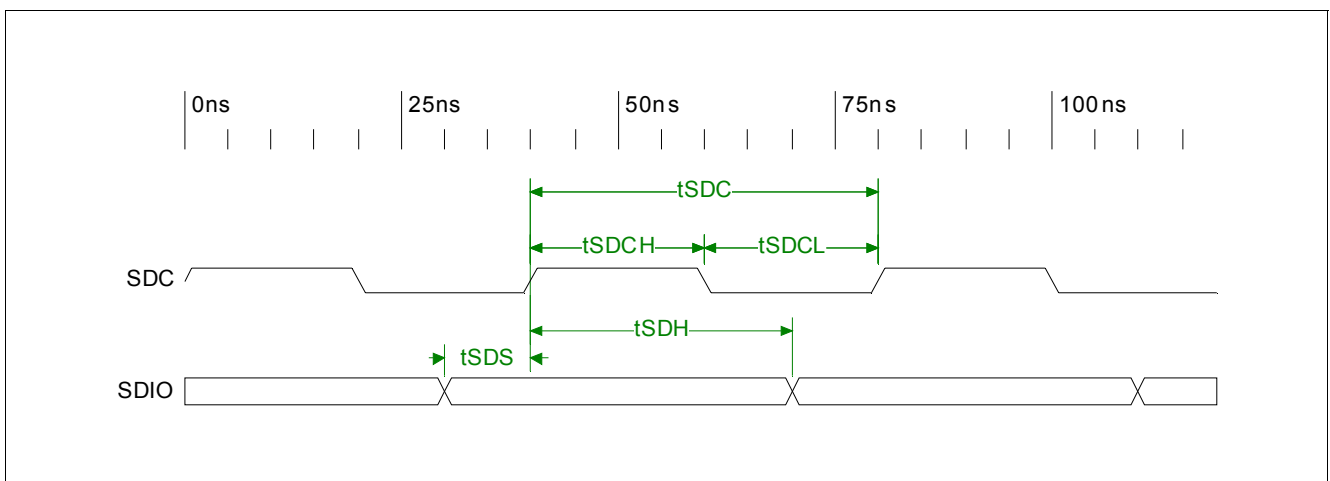

Figure 33 SDC/SDIO Timing

Table 90 SDC/SDIO Timing

Parameter	Symbol	Values			Unit	Note / Test Condition
		Min.	Typ.	Max.		
SDC Period	t_{CK}	20	–	–	ns	–
SDC Low Period	t_{CKL}	10	–	–	ns	–
SDC High Period	t_{CKH}	10	–	–	ns	–
SDIO to SDC rising setup time on read/write cycle	t_{SDS}	4	–	–	ns	–
SDIO to SDC rising hold time on read/write cycle	t_{SDH}	2	–	–	ns	–

5.3.14 MDC/MDIO Timing

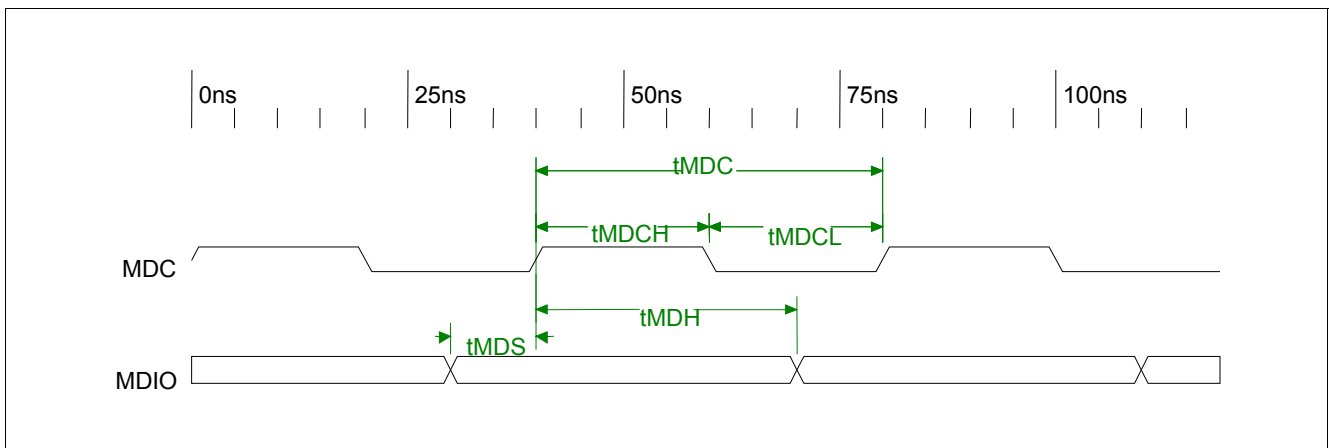

Figure 34 MDC/MDIO Timing

Table 91 MDC/MDIO Timing

Parameter	Symbol	Values			Unit	Note / Test Condition
		Min.	Typ.	Max.		
MDC Period	t_{MDC}	100	–	–	ns	–
MDC Low Period	t_{MDCL}	40	–	–	ns	–
MDC High Period	t_{MDCH}	40	–	–	ns	–
MDIO to MDC rising setup time on read/write cycle	t_{MDS}	–	–	10	ns	–
MDIO to MDC rising hold time on read/write cycle	t_{MDH}	10	–	–	ns	–

6 Package Outlines

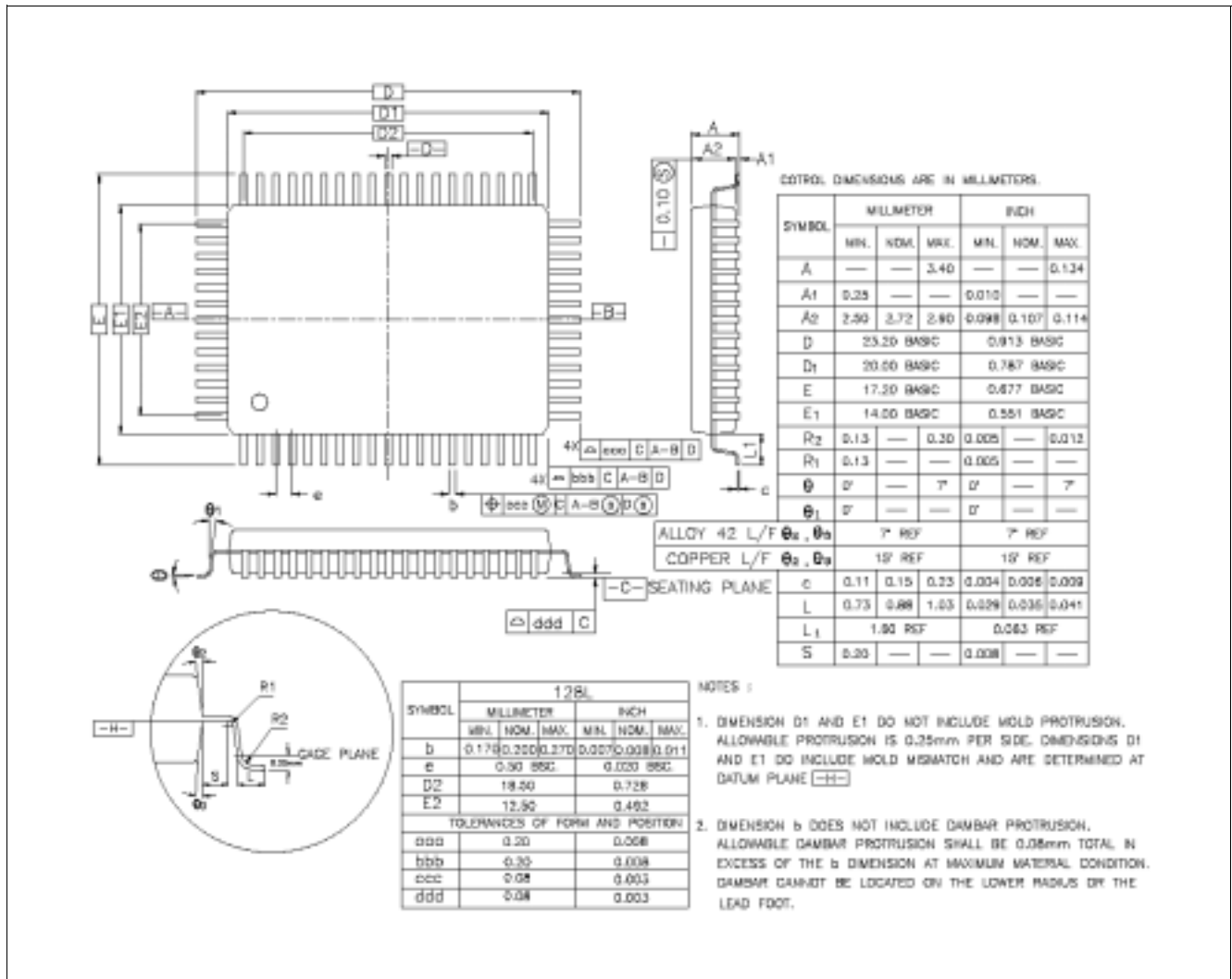

Figure 35 P-QFP-128 Outside Dimension

6.1 Package Information

Product Name	Product Type	Package
6-Port 10/100 Mbit/s Single Chip Ethernet Switch Controller	Samurai-6M/MX, ADM6996M/MX-AC-T-1, Version AC	P-QFP-128

Terminology

B

BER Bit Error Rate

C

CFI Canonical Format Indicator

COL Collision

CRC Cyclic Redundancy Check

CRS Carrier Sense

CS Chip Select

D

DA Destination Address

DI Data Input

DO Data Output

E

EDI EEPROM Data Input

EDO EEPROM Data Output

EECS EEPROM Chip Select

EESK EEPROM Clock

ESD End of Stream Delimiter

F

FEFI Far End Fault Indication

FET Field Effect Transistor

FLP Fast Link Pulse

G

GND Ground

GPSI General Purpose Serial Interface

I

IPG Inter-Packet Gap

L

LF SR Linear Feedback Shift Register

M

MAC Media Access Controller

MDIX MDI Crossover

MII Media Independent Interface

N

NRZI Non Return to Zero Inverter

NRZ Non Return to Zero

P

PCS Physical Coding Sub-layer

PHY Physical Layer

PLL Phase Lock Loop

PMA Physical Medium Attachment

PMD	Physical Medium Dependent
Q	
QoS	Quality of Service
QFP	Quad Flat Package
R	
RST	Reset
RXCLK	Receive Clock
RXD	Receive Data
RXDV	Receive Data Valid
RXER	Receive Data Errors
RXN	Receive Negative (Analog receive differential signal)
RXP	Receive Positive (Analog receive differential signal)
S	
SA	Source Address
SOHO	Small Office Home Office
SSD	Start of Stream Delimiter
SQE	Signal Quality Error
T	
TOS	Type of Service
TP	Twisted Pair
TTL	Transistor Logic
TXCLK	Transmission Clock
TXD	Transmission Data
TXEN	Transmission Enable
TXN	Transmission Negative
TXP	Transmission Positive

www.infineon.com