

N-Channel Dual Gate MOS-Fieldeffect Tetrode, Depletion Mode

Features

- Integrated gate protection diodes
- High cross modulation performance
- Low noise figure
- High AGC-range
- Low feedback capacitance
- Low input capacitance
- Lead (Pb)-free component
- Component in accordance to RoHS 2002/95/EC and WEEE 2002/96/EC

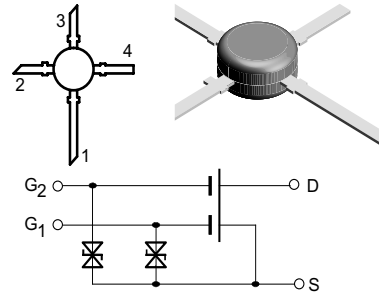

Electrostatic sensitive device. Observe precautions for handling.

13625

Applications

Input- and mixer stages especially UHF-tuners.

Mechanical Data

Case: TO-50 Plastic case

Weight: approx. 124 mg

Marking: BF966S

Pinning:

1 = Drain, 2 = Source,

3 = Gate 1, 4 = Gate 2

Parts Table

| Part | Ordering Ccode | Marking | Package |
|---------|--------------------|---------|---------|
| BF966S | BF966SA or BF966SB | BF966S | TO50 |
| BF966SA | BF966SA | BF966S | TO50 |
| BF966SB | BF966SB | BF966S | TO50 |

Absolute Maximum Ratings

$T_{amb} = 25\text{ }^{\circ}\text{C}$, unless otherwise specified

| Parameter | Test condition | Symbol | Value | Unit |
|-------------------------------------|---|-------------------|---------------|--------------------|
| Drain - source voltage | | V_{DS} | 20 | V |
| Drain current | | I_D | 30 | mA |
| Gate 1/Gate 2 - source peak current | | $\pm I_{G1/G2SM}$ | 10 | mA |
| Total power dissipation | $T_{amb} \leq 60\text{ }^{\circ}\text{C}$ | P_{tot} | 200 | mW |
| Channel temperature | | T_{Ch} | 150 | $^{\circ}\text{C}$ |
| Storage temperature range | | T_{stg} | - 55 to + 150 | $^{\circ}\text{C}$ |

Maximum Thermal Resistance

| Parameter | Test condition | Symbol | Value | Unit |
|-----------------|----------------|-------------|-------|------|
| Channel ambient | ¹⁾ | R_{thChA} | 450 | K/W |

¹⁾ on glass fibre printed board (40 x 25 x 1.5) mm³ plated with 35 μm Cu

Electrical DC Characteristics

T_{amb} = 25 °C, unless otherwise specified

| Parameter | Test condition | Part | Symbol | Min | Typ. | Max | Unit |
|-----------------------------------|--|---------|-------------------------|-----|------|------|------|
| Drain - source breakdown voltage | I _D = 10 μA, -V _{G1S} = -V _{G2S} = 4 V | | V _{(BR)DS} | 20 | | | V |
| Gate 1 - source breakdown voltage | ± I _{G1S} = 10 mA, V _{G2S} = V _{DS} = 0 | | ± V _{(BR)G1SS} | 8 | | 14 | V |
| Gate 2 - source breakdown voltage | ± I _{G2S} = 10 mA, V _{G1S} = V _{DS} = 0 | | ± V _{(BR)G2SS} | 8 | | 14 | V |
| Gate 1 - source leakage current | ± V _{G1S} = 5 V, V _{G2S} = V _{DS} = 0 | | ± I _{G1SS} | | | 50 | nA |
| Gate 2 - source leakage current | ± V _{G2S} = 5 V, V _{G1S} = V _{DS} = 0 | | ± I _{G2SS} | | | 50 | nA |
| Drain current | V _{DS} = 15 V, V _{G1S} = 0, V _{G2S} = 4 V | BF966S | I _{DSS} | 4 | | 18 | mA |
| | | BF966SA | I _{DSS} | 4 | | 10.5 | mA |
| | | BF966SB | I _{DSS} | 9.5 | | 18 | mA |
| Gate 1 - source cut-off voltage | V _{DS} = 15 V, V _{G2S} = 4 V, I _D = 20 μA | | -V _{G1S(OFF)} | | | 2.5 | V |
| Gate 2 - source cut-off voltage | V _{DS} = 15 V, V _{G1S} = 0, I _D = 20 μA | | -V _{G2S(OFF)} | | | 2.0 | V |

Electrical AC Characteristics

T_{amb} = 25 °C, unless otherwise specified

V_{DS} = 15 V, I_D = 10 mA, V_{G2S} = 4 V, f = 1 MHz

| Parameter | Test condition | Symbol | Min | Typ. | Max | Unit |
|--------------------------|---|--------------------|-----|------|-----|------|
| Forward transadmittance | | Y _{21s} | 15 | 18.5 | | mS |
| Gate 1 input capacitance | | C _{issg1} | | 2.2 | 2.6 | pF |
| Gate 2 input capacitance | V _{G1S} = 0, V _{G2S} = 4 V | C _{issg2} | | 1.1 | | pF |
| Feedback capacitance | | C _{rss} | | 25 | 35 | fF |
| Output capacitance | | C _{oss} | | 0.8 | 1.2 | pF |
| Power gain | G _S = 2 mS, G _L = 0.5 mS, f = 200 MHz | G _{ps} | | 25 | | dB |
| | G _S = 3.3 mS, G _L = 1 mS, f = 800 MHz | G _{ps} | | 18 | | dB |
| AGC range | V _{G2S} = 4 to -2 V, f = 800 MHz | ΔG _{ps} | 40 | | | dB |
| Noise figure | G _S = 2 mS, G _L = 0.5 mS, f = 200 MHz | F | | 1.0 | | dB |
| | G _S = 3.3 mS, G _L = 1 mS, f = 800 MHz | F | | 1.8 | | dB |

Typical Characteristics (T_{amb} = 25 °C unless otherwise specified)

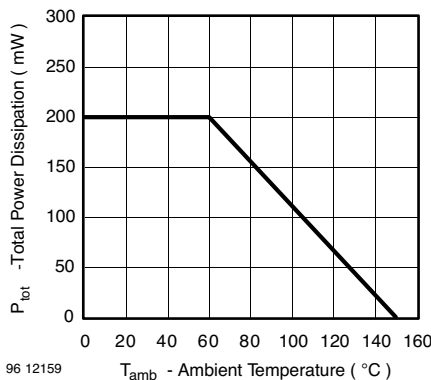

Figure 1. Total Power Dissipation vs. Ambient Temperature

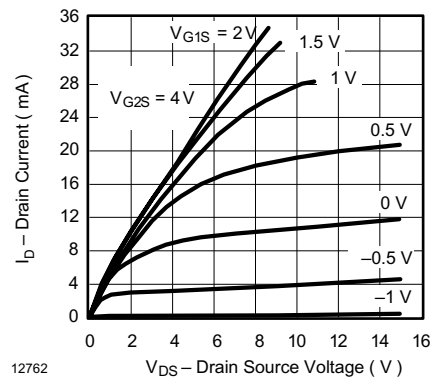

Figure 2. Drain Current vs. Drain Source Voltage

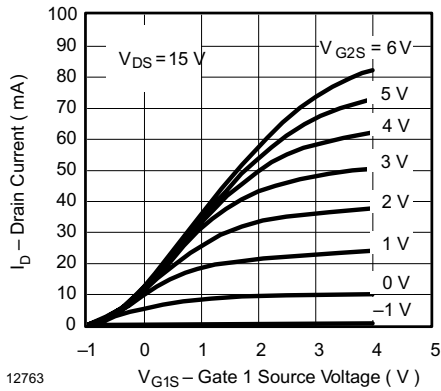

Figure 3. Drain Current vs. Gate 1 Source Voltage

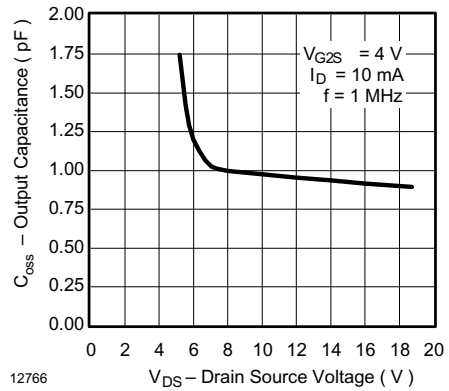

Figure 6. Output Capacitance vs. Drain Source Voltage

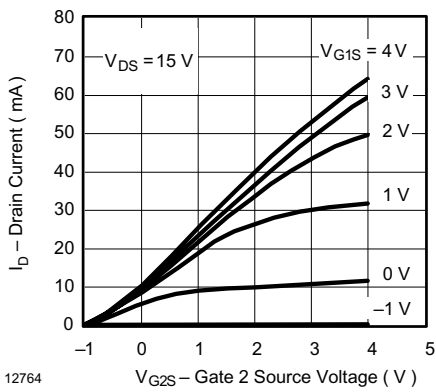

Figure 4. Drain Current vs. Gate 2 Source Voltage

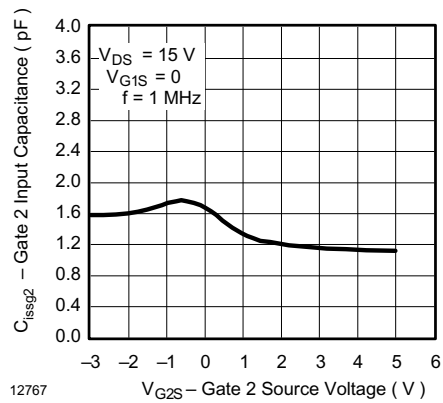

Figure 7. Gate 2 Input Capacitance vs. Gate 2 Source Voltage

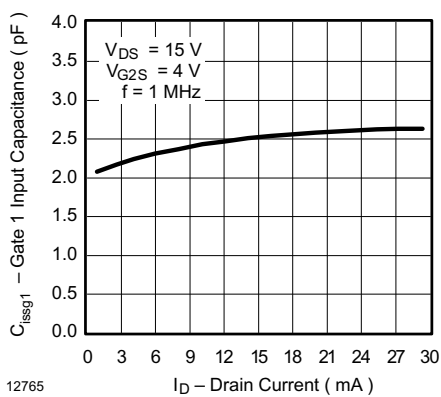

Figure 5. Gate 1 Input Capacitance vs. Drain Current

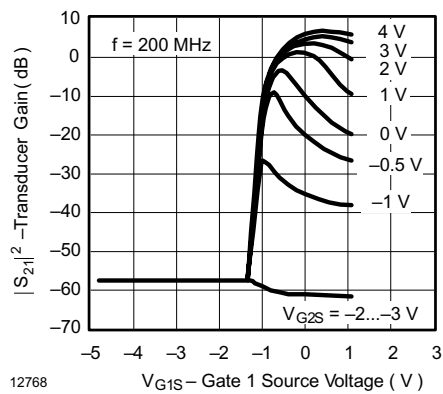

Figure 8. Transducer Gain vs. Gate 1 Source Voltage

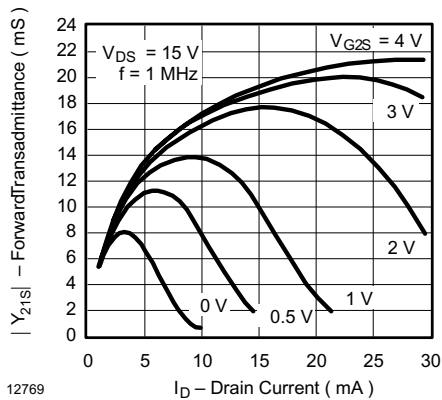

Figure 9. Forward Transadmittance vs. Drain Current

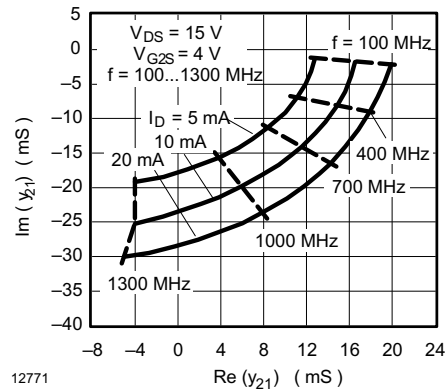

Figure 12. Short Circuit Forward Transfer Admittance

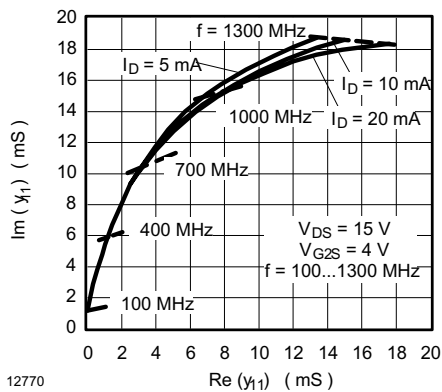

Figure 10. Short Circuit Input Admittance

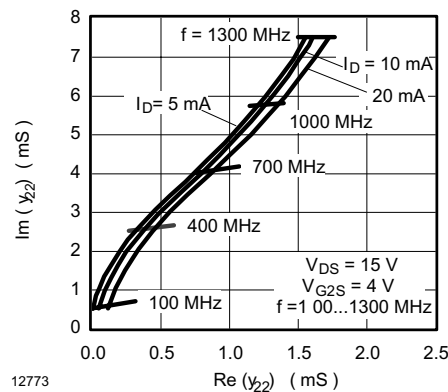

Figure 13. Short Circuit Output Admittance

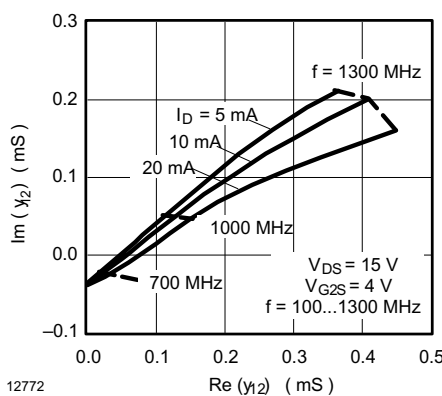
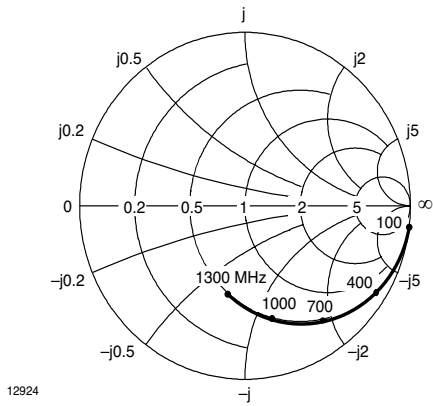

Figure 11. Short Circuit Reverse Transfer Admittance

$V_{DS} = 15\text{ V}$, $I_D = 5\text{ to }20\text{ mA}$, $V_{G2S} = 4\text{ V}$, $Z_0 = 50\ \Omega$

S_{11}



12924

Figure 14. Input Reflection Coefficient

S_{12}

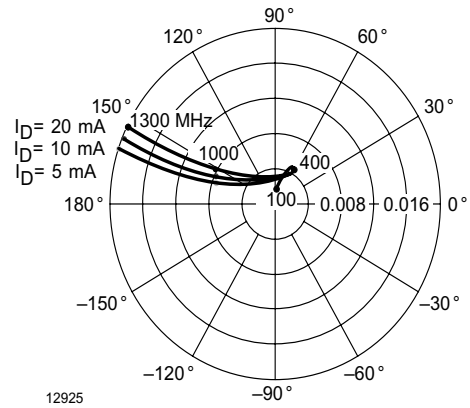

12925

Figure 16. Reverse Transmission Coefficient

S_{21}

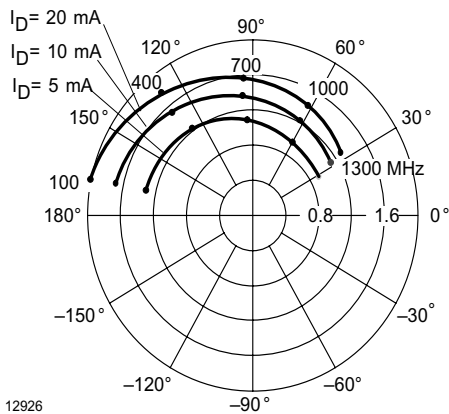

12926

Figure 15. Forward Transmission Coefficient

S_{22}

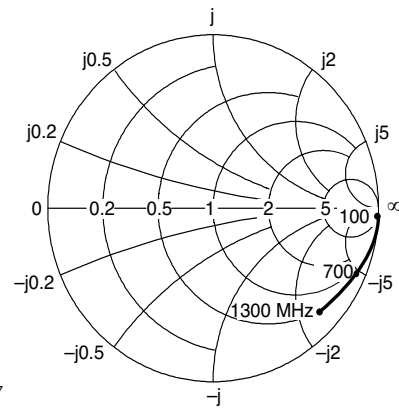

12927

Figure 17. Output Reflection Coefficient

Package Dimensions in mm

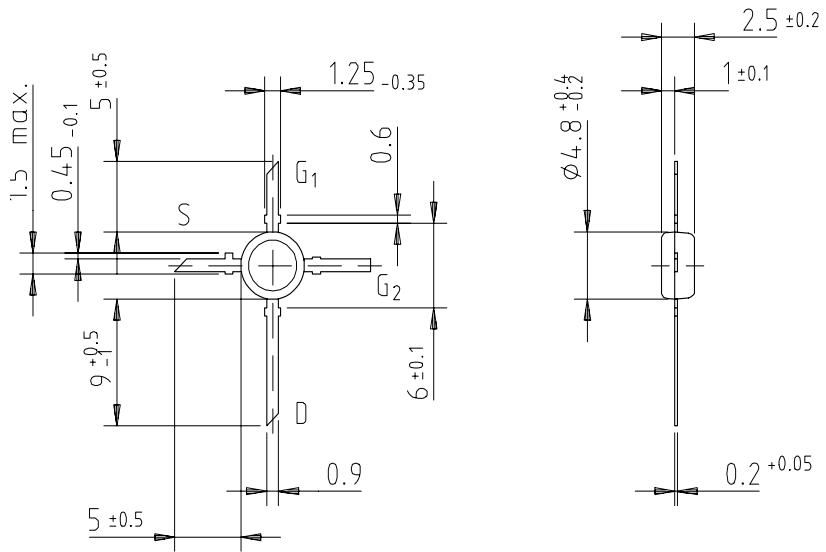

96 12242

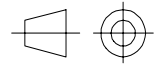

technical drawings according to DIN specifications

Ozone Depleting Substances Policy Statement

It is the policy of Vishay Semiconductor GmbH to

1. Meet all present and future national and international statutory requirements.
2. Regularly and continuously improve the performance of our products, processes, distribution and operating systems with respect to their impact on the health and safety of our employees and the public, as well as their impact on the environment.

It is particular concern to control or eliminate releases of those substances into the atmosphere which are known as ozone depleting substances (ODSs).

The Montreal Protocol (1987) and its London Amendments (1990) intend to severely restrict the use of ODSs and forbid their use within the next ten years. Various national and international initiatives are pressing for an earlier ban on these substances.

Vishay Semiconductor GmbH has been able to use its policy of continuous improvements to eliminate the use of ODSs listed in the following documents.

1. Annex A, B and list of transitional substances of the Montreal Protocol and the London Amendments respectively
2. Class I and II ozone depleting substances in the Clean Air Act Amendments of 1990 by the Environmental Protection Agency (EPA) in the USA
3. Council Decision 88/540/EEC and 91/690/EEC Annex A, B and C (transitional substances) respectively.

Vishay Semiconductor GmbH can certify that our semiconductors are not manufactured with ozone depleting substances and do not contain such substances.

We reserve the right to make changes to improve technical design
and may do so without further notice.

Parameters can vary in different applications. All operating parameters must be validated for each customer application by the customer. Should the buyer use Vishay Semiconductors products for any unintended or unauthorized application, the buyer shall indemnify Vishay Semiconductors against all claims, costs, damages, and expenses, arising out of, directly or indirectly, any claim of personal damage, injury or death associated with such unintended or unauthorized use.

Vishay Semiconductor GmbH, P.O.B. 3535, D-74025 Heilbronn, Germany



Notice

Specifications of the products displayed herein are subject to change without notice. Vishay Intertechnology, Inc., or anyone on its behalf, assumes no responsibility or liability for any errors or inaccuracies.

Information contained herein is intended to provide a product description only. No license, express or implied, by estoppel or otherwise, to any intellectual property rights is granted by this document. Except as provided in Vishay's terms and conditions of sale for such products, Vishay assumes no liability whatsoever, and disclaims any express or implied warranty, relating to sale and/or use of Vishay products including liability or warranties relating to fitness for a particular purpose, merchantability, or infringement of any patent, copyright, or other intellectual property right.

The products shown herein are not designed for use in medical, life-saving, or life-sustaining applications. Customers using or selling these products for use in such applications do so at their own risk and agree to fully indemnify Vishay for any damages resulting from such improper use or sale.