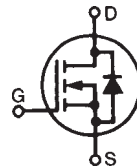

**LinearL2™ Power
MOSFET w/Extended
FBSOA**
**IXTK60N50L2
IXTX60N50L2**

 N-Channel Enhancement Mode
Avalanche Rated

$$V_{DSS} = 500V$$

$$I_{D25} = 60A$$

$$R_{DS(on)} \leq 100m\Omega$$

Symbol	Test Conditions	Maximum Ratings	
V_{DSS}	$T_J = 25^\circ C$ to $150^\circ C$	500	V
V_{DGR}	$T_J = 25^\circ C$ to $150^\circ C$, $R_{GS} = 1M\Omega$	500	V
V_{GSS}	Continuous	± 30	V
V_{GSM}	Transient	± 40	V
I_{D25}	$T_C = 25^\circ C$	60	A
I_{DM}	$T_C = 25^\circ C$, pulse width limited by T_{JM}	150	A
I_A	$T_C = 25^\circ C$	60	A
E_{AS}	$T_C = 25^\circ C$	3	J
P_D	$T_C = 25^\circ C$	960	W
T_J		-55...+150	$^\circ C$
T_{JM}		150	$^\circ C$
T_{stg}		-55...+150	$^\circ C$
T_L	1.6mm (0.063 in.) from case for 10s	300	$^\circ C$
T_{SOLD}	Plastic body for 10s	260	$^\circ C$
M_d	Mounting torque (IXTK)	1.13/10	Nm/lb.in.
F_c	Mounting Force (IXTX)	20..120 / 4.5..27	N/lb.
Weight	TO-264	10	g
	PLUS247	6	g

TO-264

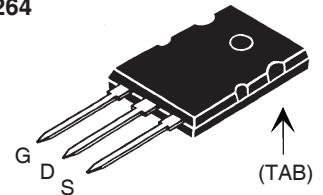

PLUS247

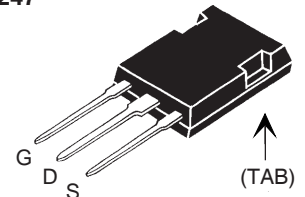

G = Gate D = Drain
S = Source TAB = Drain

Features

- Designed for linear operation
- International standard packages
- Avalanche rated
- Guaranteed FBSOA at $75^\circ C$

Advantages

- Easy to mount
- Space savings
- High power density

Applications

- Solid state circuit breakers
- Soft start controls
- Linear amplifiers
- Programmable loads
- Current regulators

Symbol	Test Conditions	Characteristic Values		
		Min.	Typ.	Max.
BV_{DSS}	$V_{GS} = 0V$, $I_D = 1mA$	500		V
$V_{GS(th)}$	$V_{DS} = V_{GS}$, $I_D = 250\mu A$	2.5		V
I_{GSS}	$V_{GS} = \pm 30V$, $V_{DS} = 0V$			± 200 nA
I_{DSS}	$V_{DS} = V_{DSS}$			50 μA
	$V_{GS} = 0V$ $T_J = 125^\circ C$			5 mA
$R_{DS(on)}$	$V_{GS} = 10V$, $I_D = 0.5 \cdot I_{D25}$, Note 1			100 m Ω

Symbol	Test Conditions ($T_J = 25^\circ\text{C}$, unless otherwise specified)	Characteristic Values			
		Min.	Typ.	Max.	
g_{fs}	$V_{DS} = 10\text{V}$, $I_D = 0.5 \cdot I_{D25}$, Note 1	18	25	32	S
C_{iss}	$V_{GS} = 0\text{V}$, $V_{DS} = 25\text{V}$, $f = 1\text{MHz}$		24		nF
C_{oss}			1325		pF
C_{rss}			172		pF
$t_{d(on)}$	Resistive Switching Times $V_{GS} = 10\text{V}$, $V_{DS} = 0.5 \cdot V_{DSS}$, $I_D = 0.5 \cdot I_{D25}$ $R_G = 0.5\Omega$ (External)		40		ns
t_r			40		ns
$t_{d(off)}$			165		ns
t_f			38		ns
$Q_{g(on)}$	$V_{GS} = 10\text{V}$, $V_{DS} = 0.5 \cdot V_{DSS}$, $I_D = 0.5 \cdot I_{D25}$		610		nC
Q_{gs}			130		nC
Q_{gd}			365		nC
R_{thJC}				0.13	$^\circ\text{C/W}$
R_{thCS}				0.15	$^\circ\text{C/W}$

Safe Operating Area Specification

Symbol	Test Conditions	Characteristic Values			
		Min.	Typ.	Max.	
SOA	$V_{DS} = 400\text{V}$, $I_D = 1.1\text{A}$, $T_C = 75^\circ\text{C}$, $t_p = 3\text{s}$	440			W

Source-Drain Diode

Symbol	Test Conditions ($T_J = 25^\circ\text{C}$, unless otherwise specified)	Characteristic Values			
		Min.	Typ.	Max.	
I_S	$V_{GS} = 0\text{V}$			60	A
I_{SM}	Repetitive, pulse width limited by T_{JM}			240	A
V_{SD}	$I_F = I_S$, $V_{GS} = 0\text{V}$, Note 1			1.5	V
t_{rr}	$I_F = 60\text{A}$, $-di/dt = 100\text{A}/\mu\text{s}$, $V_R = 100\text{V}$, $V_{GS} = 0\text{V}$		980		ns
I_{RM}			73		A
Q_{RM}			35.8		μC

Notes: 1. Pulse test, $t \leq 300\mu\text{s}$; duty cycle, $d \leq 2\%$.

PRELIMINARY TECHNICAL INFORMATION

The product presented herein is under development. The Technical Specifications offered are derived from data gathered during objective characterizations of preliminary engineering lots; but also may yet contain some information supplied during a pre-production design evaluation. IXYS reserves the right to change limits, test conditions, and dimensions without notice.

IXYS reserves the right to change limits, test conditions, and dimensions.

IXYS MOSFETs and IGBTs are covered by one or more of the following U.S. patents: 4,835,592 4,931,844 5,049,961 5,237,481 6,162,665 6,404,065 B1 6,683,344 6,727,585 7,005,734 B2 7,157,338 B2
4,850,072 5,017,508 5,063,307 5,381,025 6,259,123 B1 6,534,343 6,710,405 B2 6,759,692 7,063,975 B2
4,881,106 5,034,796 5,187,117 5,486,715 6,306,728 B1 6,583,505 6,710,463 6,771,478 B2 7,071,537

TO-264 (IXTK) Outline

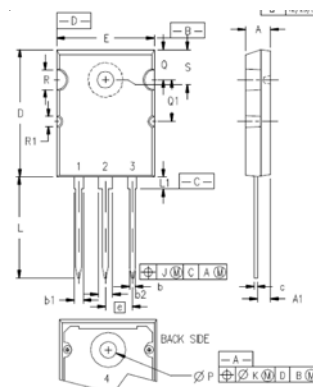

SYM	INCHES		MILLIMETERS	
	MIN	MAX	MIN	MAX
A	.185	.209	4.70	5.31
A1	.102	.118	2.59	3.00
b	.037	.055	0.94	1.40
b1	.087	.102	2.21	2.59
b2	.110	.126	2.79	3.20
c	.017	.029	0.43	0.74
D	1.007	1.047	25.58	26.59
E	.760	.799	19.30	20.29
e	.215 BSC		5.46 BSC	
J	.000	.010	0.00	0.25
K	.000	.010	0.00	0.25
L	.779	.842	19.79	21.39
L1	.087	.102	2.21	2.59
$\varnothing P$.122	.138	3.10	3.51
Q	.240	.256	6.10	6.50
Q1	.330	.346	8.38	8.79
$\varnothing R$.155	.187	3.94	4.75
$\varnothing R1$.085	.093	2.16	2.36
S	.243	.253	6.17	6.43

PLUS 247™ (IXTX) Outline

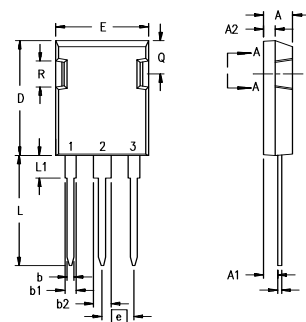

Dim.	Millimeter		Inches	
	Min.	Max.	Min.	Max.
A	4.83	5.21	.190	.205
A ₁	2.29	2.54	.090	.100
A ₂	1.91	2.16	.075	.085
b	1.14	1.40	.045	.055
b ₁	1.91	2.13	.075	.084
b ₂	2.92	3.12	.115	.123
C	0.61	0.80	.024	.031
D	20.80	21.34	.819	.840
E	15.75	16.13	.620	.635
e	5.45 BSC		.215 BSC	
L	19.81	20.32	.780	.800
L1	3.81	4.32	.150	.170
Q	5.59	6.20	.220	0.244
R	4.32	4.83	.170	.190

Fig. 1. Output Characteristics @ 25°C

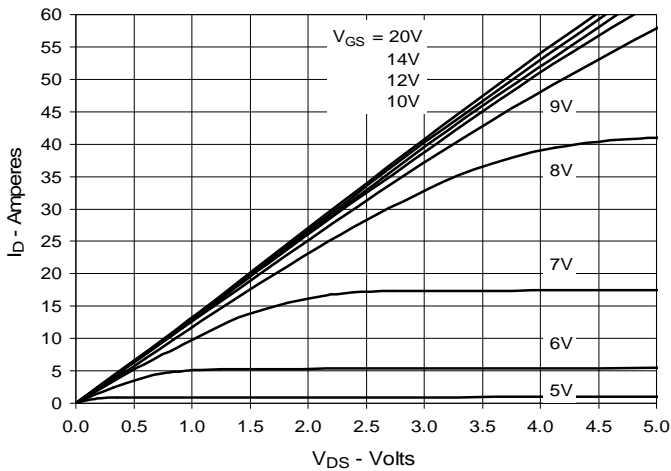

Fig. 2. Extended Output Characteristics @ 25°C

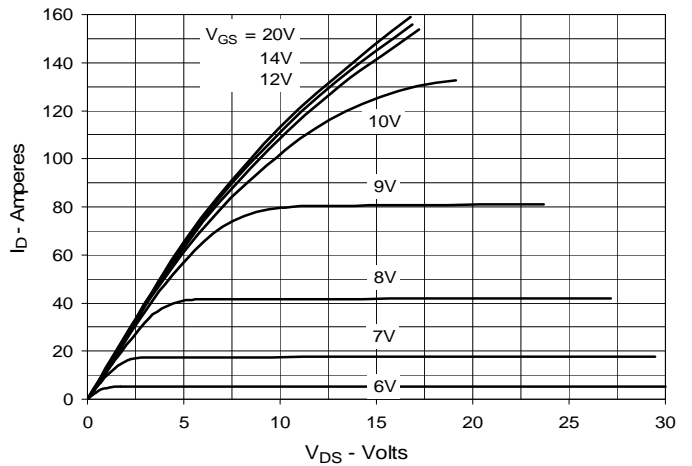

Fig. 3. Output Characteristics @ 125°C

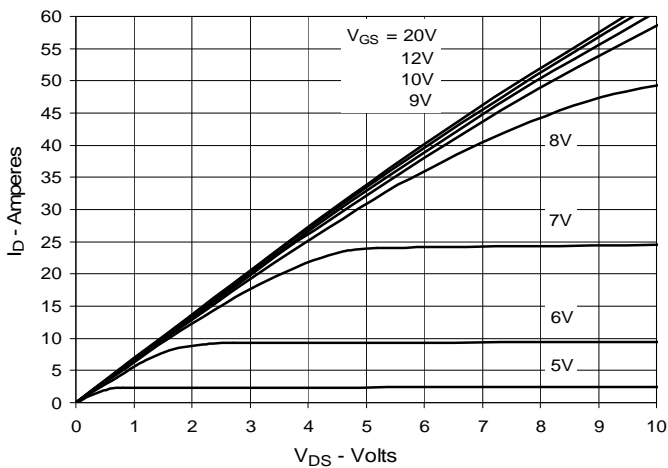

Fig. 4. $R_{DS(on)}$ Normalized to $I_D = 30A$ Value vs. Junction Temperature

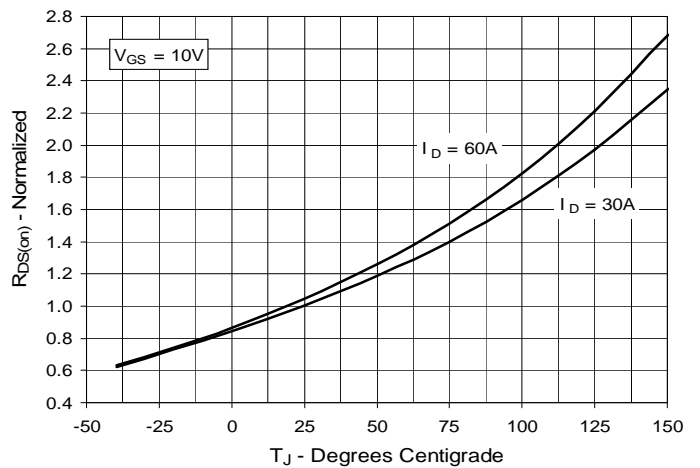

Fig. 5. $R_{DS(on)}$ Normalized to $I_D = 30A$ Value vs. Drain Current

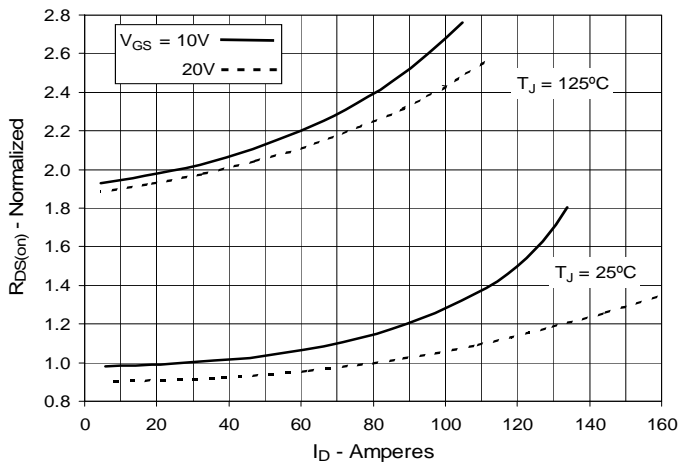

Fig. 6. Maximum Drain Current vs. Case Temperature

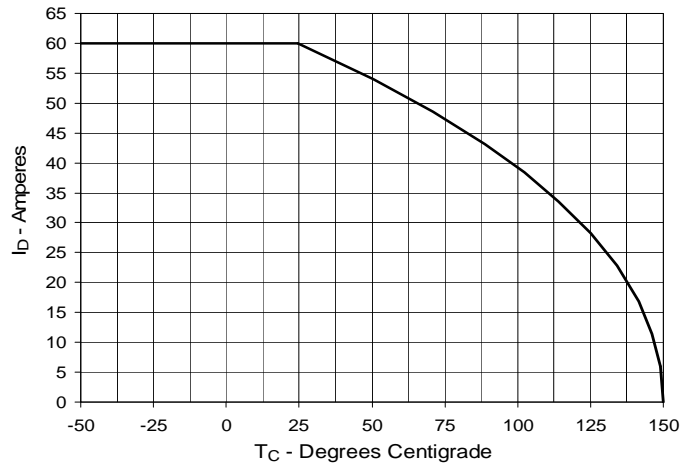

Fig. 7. Input Admittance

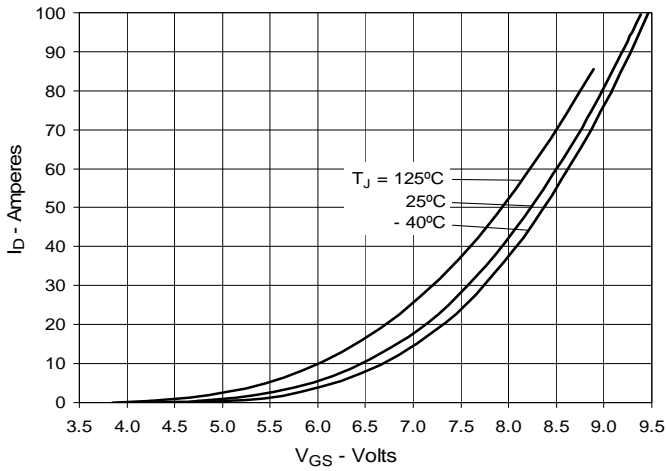

Fig. 8. Transconductance

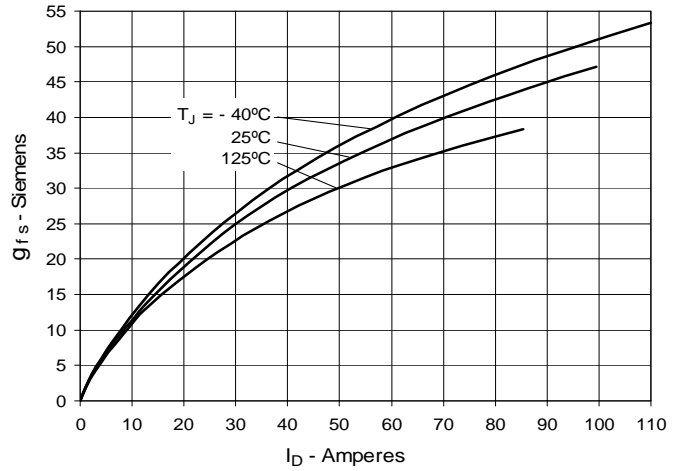

Fig. 9. Forward Voltage Drop of Intrinsic Diode

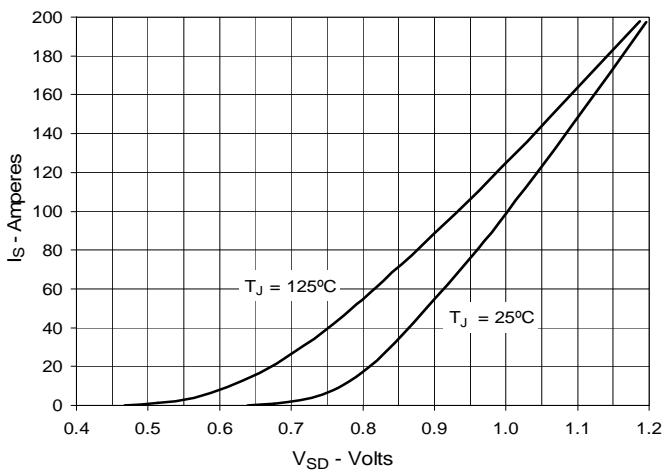

Fig. 10. Gate Charge

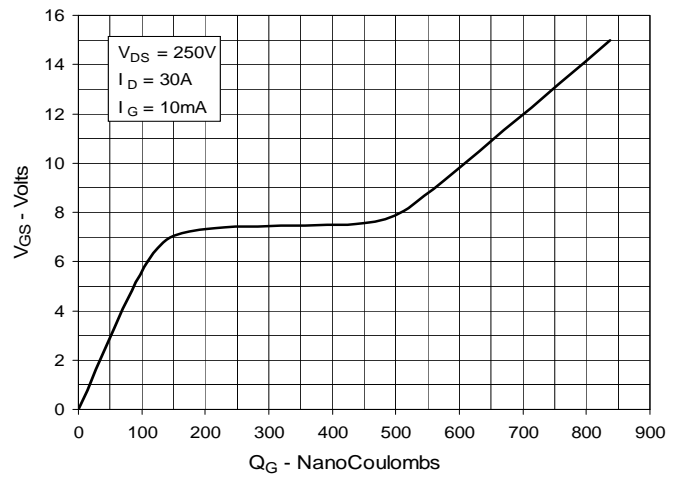

Fig. 11. Capacitance

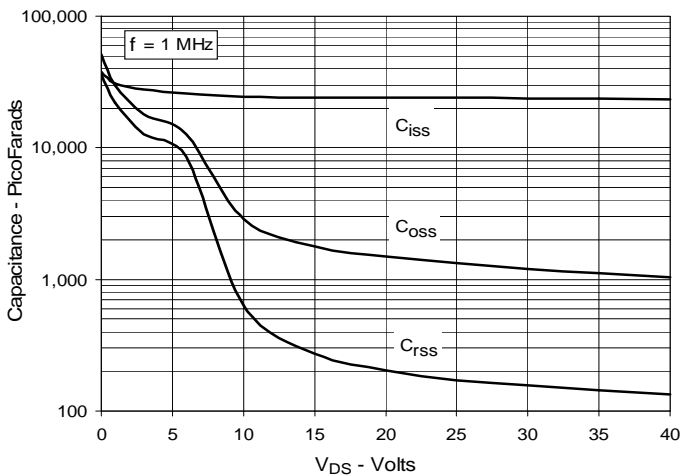
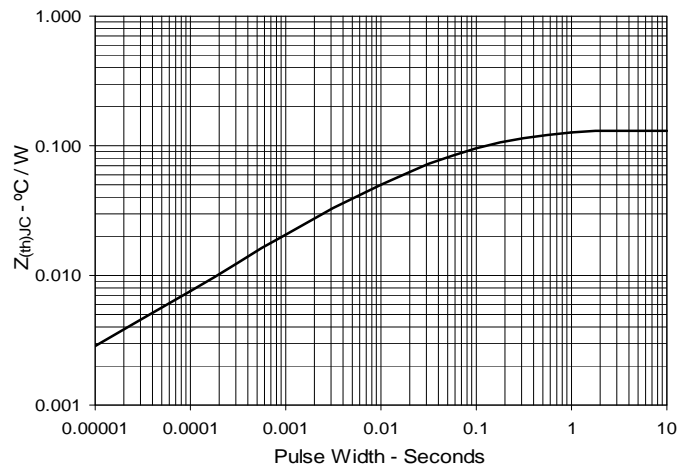
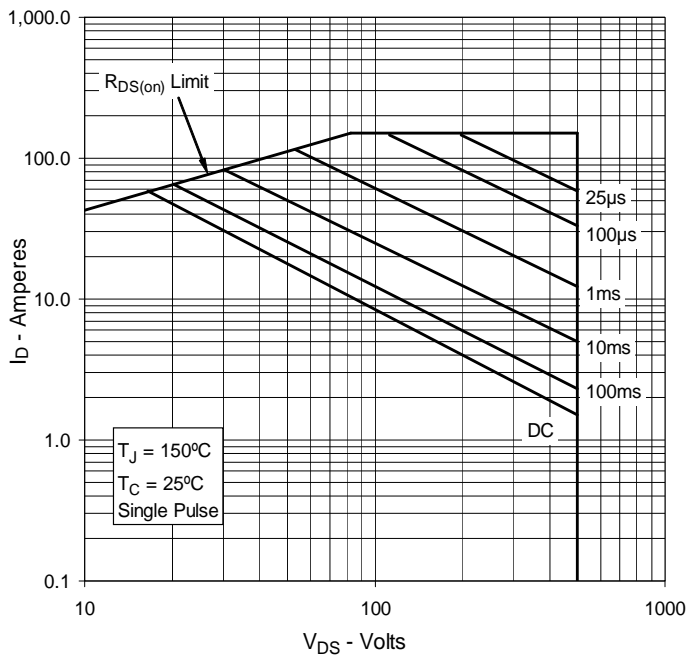

Fig. 12. Maximum Transient Thermal Impedance



**Fig. 13. Forward-Bias Safe Operating Area
@ $T_C = 25^\circ\text{C}$**



**Fig. 14. Forward-Bias Safe Operating Area
@ $T_C = 75^\circ\text{C}$**

