

# DUAL SMALL SIGNAL SURFACE MOUNT TRANSISTOR

## FEATURE

- We declare that the material of product is ROHS compliant and halogen free.
- S- Prefix for Automotive and Other Applications Requiring Unique Site and Control Change Requirements; AEC-Q101 Qualified and PPAP Capable.

## DEVICE MARKING AND ORDERING INFORMATION

Device	Marking	Shipping
LMBT4413DW1T1G S-LMBT4413DW1T1G	K13	3000/Tape&Reel
LMBT4413DW1T3G S-LMBT4413DW1T3G	K13	10000/Tape&Reel

### MAXIMUM RATINGS – NPN

Rating	Symbol	Value	Unit
Collector–Emitter Voltage	$V_{CEO}$	40	Vdc
Collector–Base Voltage	$V_{CBO}$	60	Vdc
Emitter–Base Voltage	$V_{EBO}$	6.0	Vdc
Collector Current — Continuous	$I_C$	600	mAdc

### MAXIMUM RATINGS – PNP

Rating	Symbol	Value	Unit
Collector–Emitter Voltage	$V_{CEO}$	-40	Vdc
Collector–Base Voltage	$V_{CBO}$	-60	Vdc
Emitter–Base Voltage	$V_{EBO}$	-5.0	Vdc
Collector Current — Continuous	$I_C$	-600	mAdc

## THERMAL CHARACTERISTICS

Characteristic	Symbol	Max	Unit
Total Device Dissipation FR– 5 Board, (1) $T_A = 25^\circ\text{C}$	$P_D$	225	mW
Derate above $25^\circ\text{C}$		1.8	mW/ $^\circ\text{C}$
Thermal Resistance, Junction to Ambient	$R_{\theta JA}$	556	$^\circ\text{C}/\text{W}$
Total Device Dissipation Alumina Substrate, (2) $T_A = 25^\circ\text{C}$	$P_D$	300	mW
Derate above $25^\circ\text{C}$		2.4	mW/ $^\circ\text{C}$
Thermal Resistance, Junction to Ambient	$R_{\theta JA}$	417	$^\circ\text{C}/\text{W}$
Junction and Storage Temperature	$T_J, T_{stg}$	-55 to +150	$^\circ\text{C}$

1. FR–5 = 1.0 x 0.75 x 0.062 in.
2. Alumina = 0.4 x 0.3 x 0.024 in. 99.5% alumina.

## LMBT4413DW1T1G S-LMBT4413DW1T1G

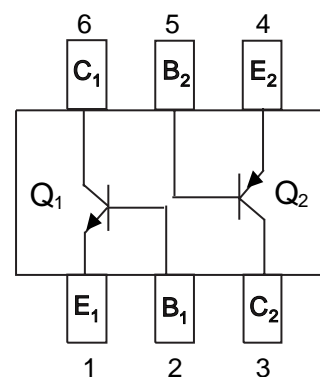
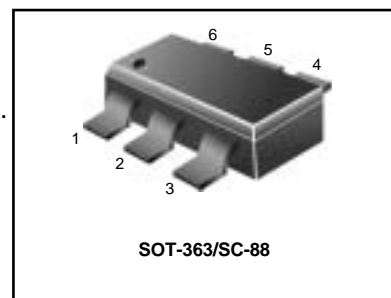

## LMBT4413DW1T1G;S-LMBT4413DW1T1G

### ELECTRICAL CHARACTERISTICS (T<sub>A</sub> = 25°C unless otherwise noted.)

Characteristic	Symbol	Min	Max	Unit
----------------	--------	-----	-----	------

#### Q1(NPN) OFF CHARACTERISTICS

Collector–Emitter Breakdown Voltage (3) (I <sub>C</sub> = 1.0 mA <sub>dc</sub> , I <sub>B</sub> = 0)	V <sub>(BR)CEO</sub>	40	—	V <sub>dc</sub>
Collector–Base Breakdown Voltage (I <sub>C</sub> = 0.1 mA <sub>dc</sub> , I <sub>E</sub> = 0)	V <sub>(BR)CBO</sub>	60	—	V <sub>dc</sub>
Emitter–Base Breakdown Voltage (I <sub>E</sub> = 0.1 mA <sub>dc</sub> , I <sub>C</sub> = 0)	V <sub>(BR)EBO</sub>	6.0	—	V <sub>dc</sub>
Base Cutoff Current (V <sub>CE</sub> = 35 V <sub>dc</sub> , V <sub>EB</sub> = 0.4 V <sub>dc</sub> )	I <sub>BEV</sub>	—	0.1	μA <sub>dc</sub>
Collector Cutoff Current (V <sub>CE</sub> = 35 V <sub>dc</sub> , V <sub>EB</sub> = 0.4 V <sub>dc</sub> )	I <sub>CEX</sub>	—	0.1	μA <sub>dc</sub>

#### Q2(PNP) OFF CHARACTERISTICS

Collector–Emitter Breakdown Voltage (3) (I <sub>C</sub> = -1.0 mA <sub>dc</sub> , I <sub>B</sub> = 0)	V <sub>(BR)CEO</sub>	-40	—	V <sub>dc</sub>
Collector–Base Breakdown Voltage (I <sub>C</sub> = -0.1 mA <sub>dc</sub> , I <sub>E</sub> = 0)	V <sub>(BR)CBO</sub>	-60	—	V <sub>dc</sub>
Emitter–Base Breakdown Voltage (I <sub>E</sub> = -0.1 mA <sub>dc</sub> , I <sub>C</sub> = 0)	V <sub>(BR)EBO</sub>	-5.0	—	V <sub>dc</sub>
Base Cutoff Current (V <sub>CE</sub> = -35 V <sub>dc</sub> , V <sub>EB</sub> = -0.4 V <sub>dc</sub> )	I <sub>BEV</sub>	—	-0.1	μA <sub>dc</sub>
Collector Cutoff Current (V <sub>CE</sub> = -35 V <sub>dc</sub> , V <sub>EB</sub> = -0.4 V <sub>dc</sub> )	I <sub>CEX</sub>	—	-0.1	μA <sub>dc</sub>

- FR-5 = 1.0 x 0.75 x 0.062 in.
- Alumina = 0.4 x 0.3 x 0.024 in. 99.5% alumina.
- Pulse Test: Pulse Width <<300 μs; Duty Cycle <<2.0%.

## LMBT4413DW1T1G;S-LMBT4413DW1T1G

### Q1(NPN) ELECTRICAL CHARACTERISTICS (T<sub>A</sub> = 25°C unless otherwise noted)

Characteristic	Symbol	Min	Max	Unit
----------------	--------	-----	-----	------

#### ON CHARACTERISTICS ( 3 )

DC Current Gain (I <sub>C</sub> = 0.1 mA <sub>dc</sub> , V <sub>CE</sub> = 1.0 V <sub>dc</sub> )	h <sub>FE</sub>	20	—	—
(I <sub>C</sub> = 1.0 mA <sub>dc</sub> , V <sub>CE</sub> = 1.0 V <sub>dc</sub> )		40	—	
(I <sub>C</sub> = 10 mA <sub>dc</sub> , V <sub>CE</sub> = 1.0 V <sub>dc</sub> )		80	—	
(I <sub>C</sub> = 150 mA <sub>dc</sub> , V <sub>CE</sub> = 1.0 V <sub>dc</sub> )		100	300	
(I <sub>C</sub> = 500 mA <sub>dc</sub> , V <sub>CE</sub> = 2.0 V <sub>dc</sub> )		40	—	
Collector–Emitter Saturation Voltage (I <sub>C</sub> = 150 mA <sub>dc</sub> , I <sub>B</sub> = 15 mA <sub>dc</sub> )	V <sub>CE(sat)</sub>	—	0.4	V <sub>dc</sub>
(I <sub>C</sub> = 500 mA <sub>dc</sub> , I <sub>B</sub> = 50 mA <sub>dc</sub> )		—	0.75	
Base–Emitter Saturation Voltage (I <sub>C</sub> = 150 mA <sub>dc</sub> , I <sub>B</sub> = 15 mA <sub>dc</sub> )	V <sub>BE(sat)</sub>	0.75	0.95	V <sub>dc</sub>
(I <sub>C</sub> = 500 mA <sub>dc</sub> , I <sub>B</sub> = 50 mA <sub>dc</sub> )		—	1.2	

#### SMALL–SIGNAL CHARACTERISTICS

Current–Gain — Bandwidth Product (I <sub>C</sub> = 20 mA <sub>dc</sub> , V <sub>CE</sub> = 10V <sub>dc</sub> , f = 100 MHz)	f <sub>T</sub>	250	—	MHz
Collector–Base Capacitance (V <sub>CB</sub> = 5.0 V <sub>dc</sub> , I <sub>E</sub> = 0, f = 1.0 MHz)	C <sub>cb</sub>	—	6.5	pF
Emitter–Base Capacitance (V <sub>EB</sub> = 0.5 V <sub>dc</sub> , I <sub>C</sub> = 0, f = 1.0 MHz)	C <sub>eb</sub>	—	30	pF
Input Impedance (V <sub>CE</sub> = 10 V <sub>dc</sub> , I <sub>C</sub> = 1.0 mA <sub>dc</sub> , f = 1.0 kHz)	h <sub>ie</sub>	1.0	15	kΩ
Voltage Feedback Ratio (V <sub>CE</sub> = 10 V <sub>dc</sub> , I <sub>C</sub> = 1.0 mA <sub>dc</sub> , f = 1.0 kHz)	h <sub>re</sub>	0.1	8.0	X 10 <sup>-4</sup>
Small–Signal Current Gain (V <sub>CE</sub> = 10 V <sub>dc</sub> , I <sub>C</sub> = 1.0 mA <sub>dc</sub> , f = 1.0 kHz)	h <sub>fe</sub>	40	500	—
Output Admittance (V <sub>CE</sub> = 10 V <sub>dc</sub> , I <sub>C</sub> = 1.0 mA <sub>dc</sub> , f = 1.0 kHz)	h <sub>oe</sub>	1.0	30	μmhos

#### SWITCHING CHARACTERISTICS

Delay Time	(V <sub>CC</sub> = 30 V <sub>dc</sub> , V <sub>EB</sub> = 2.0 V <sub>dc</sub> I <sub>C</sub> = 150 mA <sub>dc</sub> , I <sub>B1</sub> = 15 mA <sub>dc</sub> )	t <sub>d</sub>	—	15	ns
Rise Time		t <sub>r</sub>	—	20	
Storage Time	(V <sub>CC</sub> = 30 V <sub>dc</sub> , I <sub>C</sub> = 150 mA <sub>dc</sub> I <sub>B1</sub> = I <sub>B2</sub> = 15 mA <sub>dc</sub> )	t <sub>s</sub>	—	225	ns
Fall Time		t <sub>f</sub>	—	30	

3. Pulse Test: Pulse Width ≤ 300 μs; Duty Cycle ≤ 2.0%.

#### SWITCHING TIME EQUIVALENT TEST CIRCUITS (Q1 NPN)

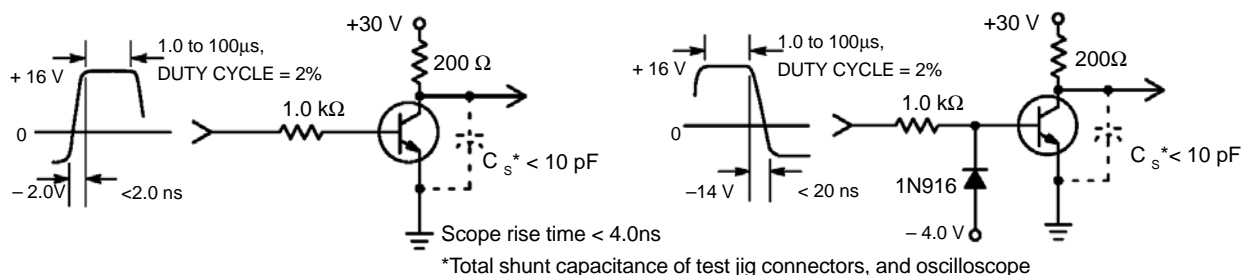

Figure 1. Turn–On Time

Figure 2. Turn–Off Time

## LMBT4413DW1T1G ;S-LMBT4413DW1T1G

### Q2(PNP) ELECTRICAL CHARACTERISTICS (T<sub>A</sub> = 25°C unless otherwise noted)

Characteristic	Symbol	Min	Max	Unit
----------------	--------	-----	-----	------

#### ON CHARACTERISTICS

DC Current Gain (I <sub>C</sub> = -0.1 mA, V <sub>CE</sub> = -1.0 Vdc)	h <sub>FE</sub>	30	—	—
(I <sub>C</sub> = -1.0 mA, V <sub>CE</sub> = -1.0 Vdc)		60	—	
(I <sub>C</sub> = -10 mA, V <sub>CE</sub> = -1.0 Vdc)		100	—	
(I <sub>C</sub> = -150 mA, V <sub>CE</sub> = -2.0 Vdc)(3)		100	300	
(I <sub>C</sub> = -500 mA, V <sub>CE</sub> = -2.0 Vdc)(3)		20	—	
Collector-Emitter Saturation Voltage(3) (I <sub>C</sub> = -150mA, I <sub>B</sub> = -15 mA)	V <sub>CE(sat)</sub>	—	-0.4	Vdc
(I <sub>C</sub> = -500 mA, I <sub>B</sub> = -50 mA)		—	-0.75	
Base-Emitter Saturation Voltage (3) (I <sub>C</sub> = -150 mA, I <sub>B</sub> = -15 mA)	V <sub>BE(sat)</sub>	-0.75	-0.95	Vdc
(I <sub>C</sub> = -500 mA, I <sub>B</sub> = -50 mA)		—	-1.3	

#### SMALL-SIGNAL CHARACTERISTICS

Current-Gain — Bandwidth Product (I <sub>C</sub> = -20mA, V <sub>CE</sub> = -10 Vdc, f = 100 MHz)	f <sub>T</sub>	200	—	MHz
Collector-Base Capacitance (V <sub>CB</sub> = -10 Vdc, I <sub>E</sub> = 0, f = 1.0 MHz)	C <sub>cb</sub>	—	8.5	pF
Emitter-Base Capacitance (V <sub>BE</sub> = -0.5 Vdc, I <sub>C</sub> = 0, f = 1.0 MHz)	C <sub>eb</sub>	—	30	pF
Input Impedance (V <sub>CE</sub> = -10 Vdc, I <sub>C</sub> = -1.0 mA, f = 1.0 kHz)	h <sub>ie</sub>	1.5	15	kΩ
Voltage Feedback Ratio (V <sub>CE</sub> = -10 Vdc, I <sub>C</sub> = -1.0 mA, f = 1.0 kHz)	h <sub>re</sub>	0.1	8.0	X 10 <sup>-4</sup>
Small-Signal Current Gain (V <sub>CE</sub> = -10 Vdc, I <sub>C</sub> = -1.0 mA, f = 1.0 kHz)	h <sub>fe</sub>	60	500	—
Output Admittance (V <sub>CE</sub> = -10 Vdc, I <sub>C</sub> = -1.0 mA, f = 1.0 kHz)	h <sub>oe</sub>	1.0	100	μmhos

#### SWITCHING CHARACTERISTICS

Delay Time	(V <sub>CC</sub> = -30 Vdc, V <sub>EB</sub> = -2.0 Vdc,	t <sub>d</sub>	—	15	ns
Rise Time	I <sub>C</sub> = -150mA, I <sub>B1</sub> = -15 mA)	t <sub>d</sub>	—	20	
Storage Time	(V <sub>CC</sub> = -30 Vdc, I <sub>C</sub> = -150 mA,	t <sub>s</sub>	—	225	ns
Fall Time	I <sub>B1</sub> = I <sub>B2</sub> = -15 mA)	t <sub>f</sub>	—	30	

3. Pulse Test: Pulse Width ≤ 300 μs; Duty Cycle ≤ 2.0%.

#### SWITCHING TIME EQUIVALENT TEST CIRCUITS (Q2 PNP)

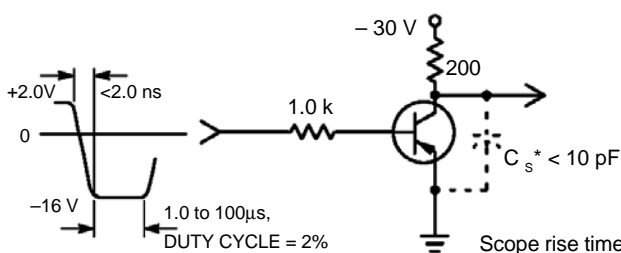

Figure 3. Turn-On Time

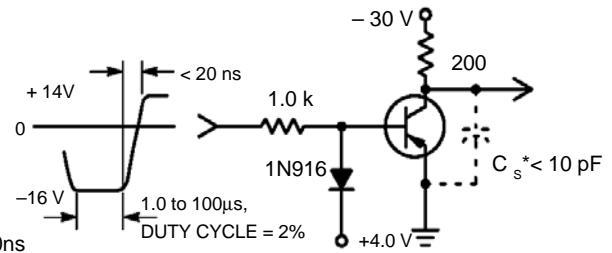

Figure 4. Turn-Off Time

\*Total shunt capacitance of test jig connectors, and oscilloscope

LMBT4413DW1T1G;S-LMBT4413DW1T1G

TRANSIENT CHARACTERISTICS (Q1 NPN)

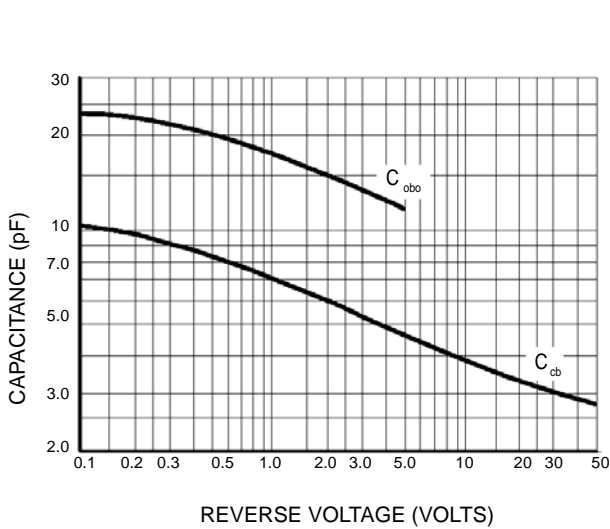

Figure 5. Capacitance

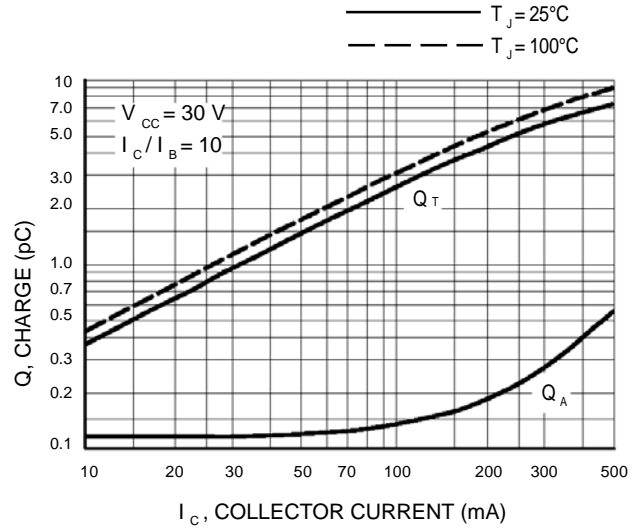

Figure 6. Charge Data

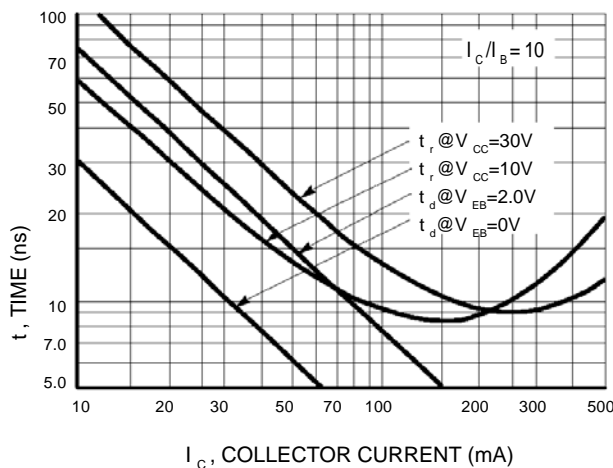

Figure 7. Turn-On Time

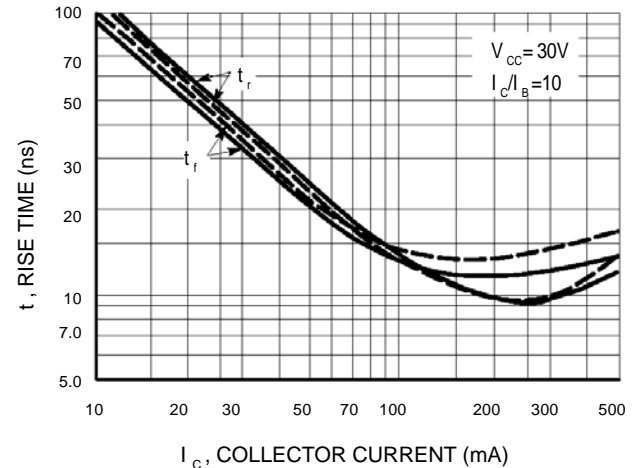

Figure 8. Rise and Fall Time

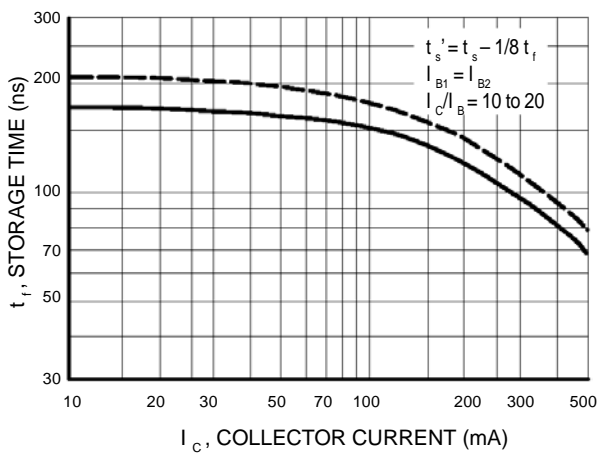

Figure 9. Storage Time

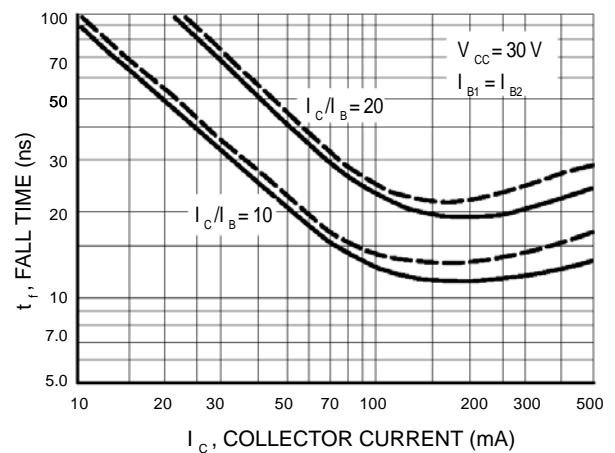

Figure 10. Fall Time

# LMBT4413DW1T1G;S-LMBT4413DW1T1G

## SMALL-SIGNAL CHARACTERISTICS(Q1 NPN)

### NOISE FIGURE

$V_{CE} = 10 \text{ Vdc}$ ,  $T_A = 25^\circ\text{C}$

Bandwidth = 1.0 Hz

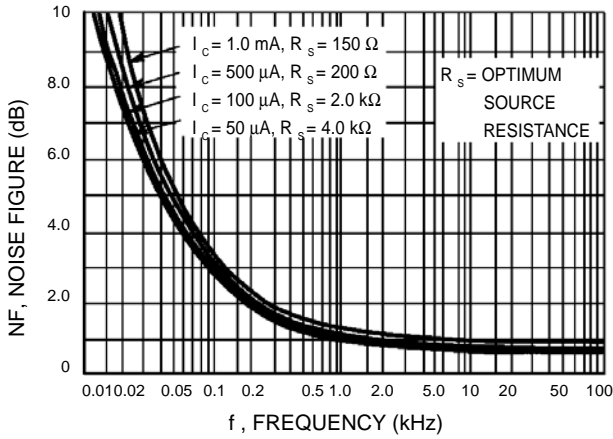

Figure 11. Frequency Effects

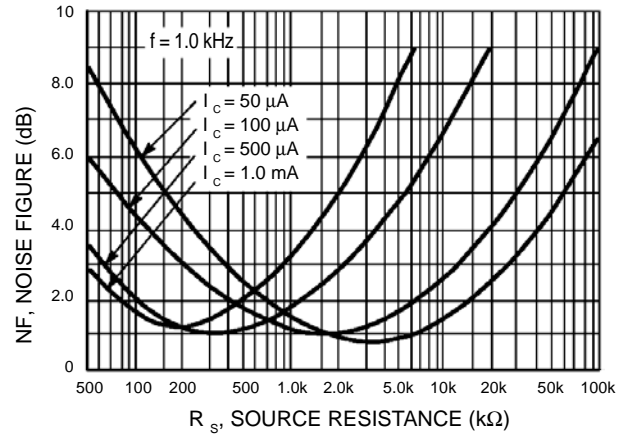

Figure 12. Source Resistance Effects

### h PARAMETERS

$(V_{CE} = 10 \text{ Vdc}$ ,  $f = 1.0 \text{ kHz}$ ,  $T_A = 25^\circ\text{C}$ )

This group of graphs illustrates the relationship between  $h_{fe}$  and other "h" parameters for this series of transistors. To obtain these curves, a high-gain and a low-gain unit were selected from the LMBT4413DW1T1G lines, and the same units were used to develop the correspondingly numbered curves on each graph.

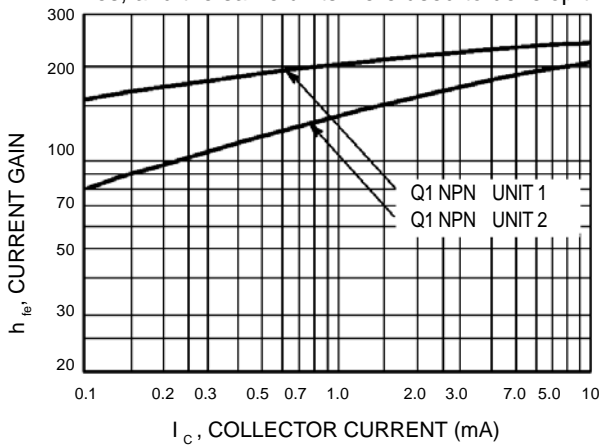

Figure 13. Current Gain

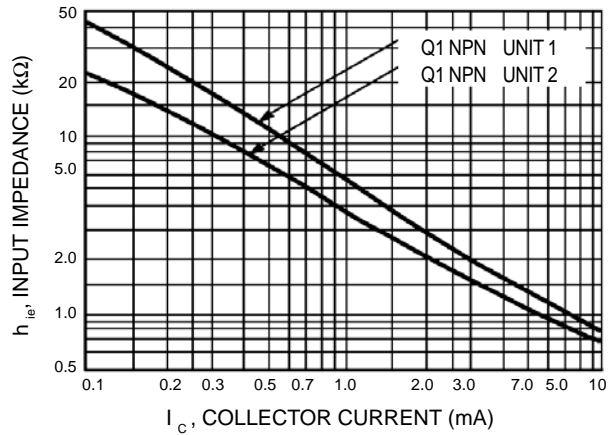

Figure 14. Input Impedance

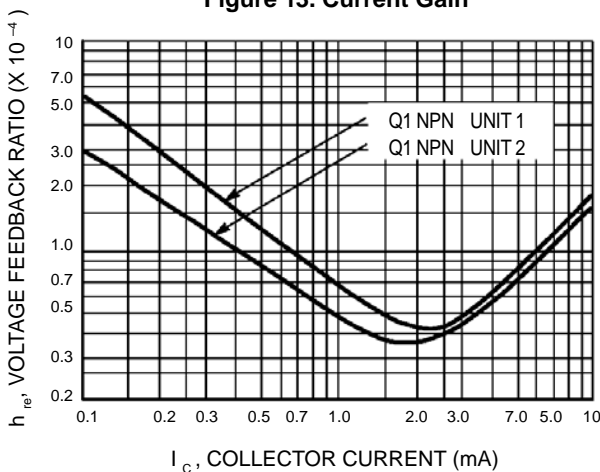

Figure 15. Voltage Feedback Ratio

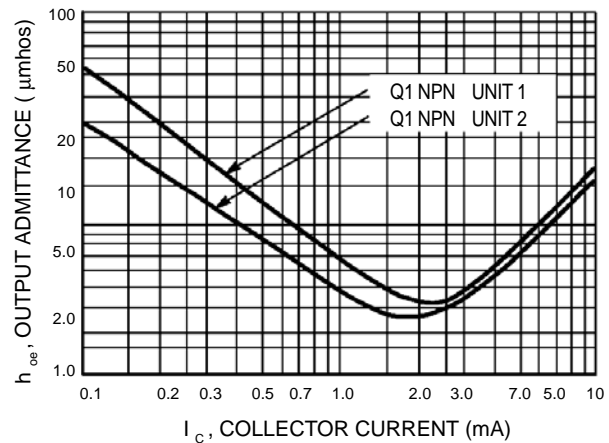

Figure 16. Output Admittance

# LMBT4413DW1T1G;S-LMBT4413DW1T1G

## STATIC CHARACTERISTICS (Q1 NPN)

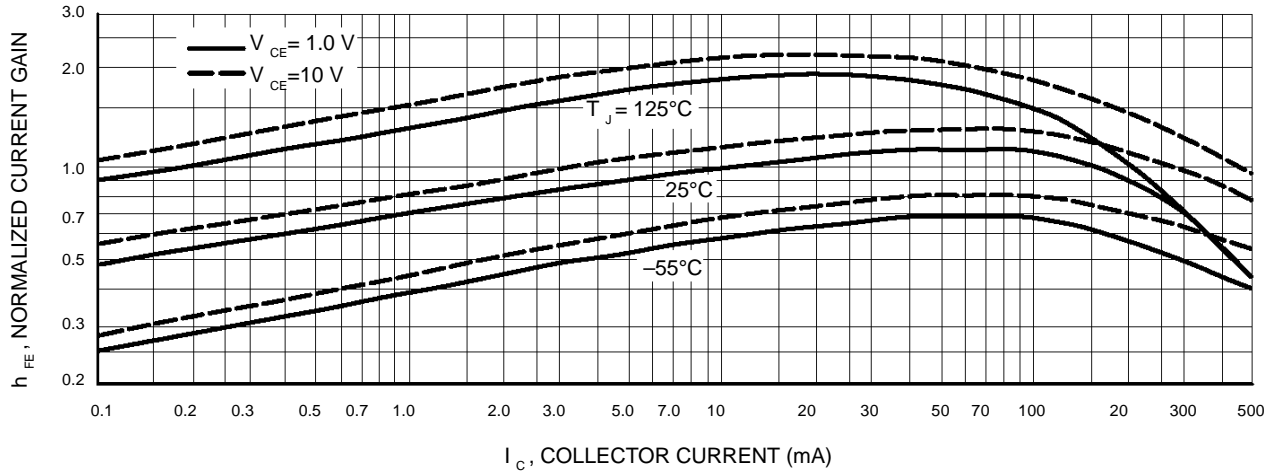

Figure 17. DC Current Gain

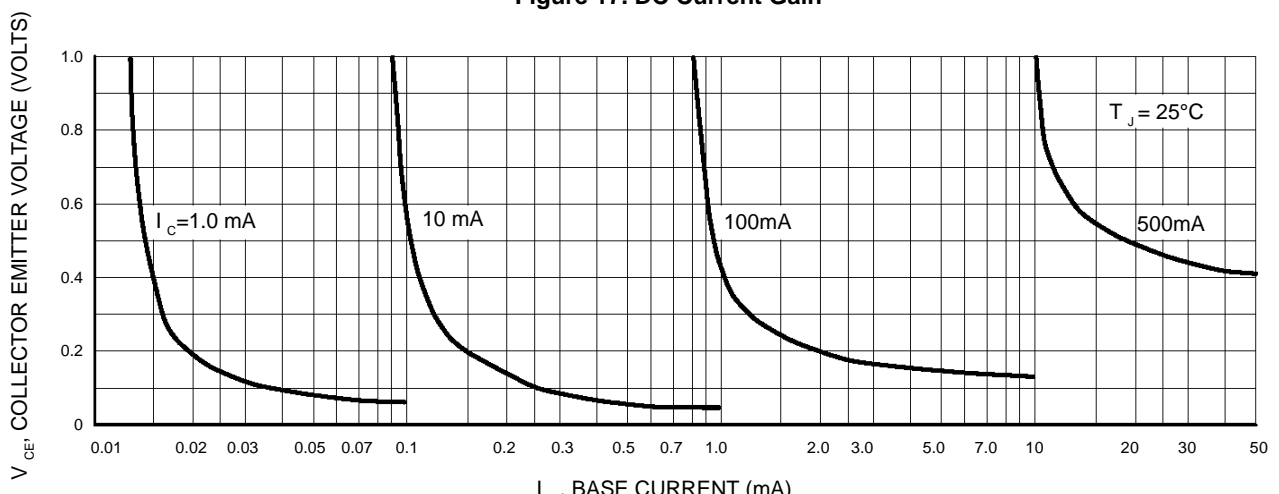

Figure 18. Collector Saturation Region

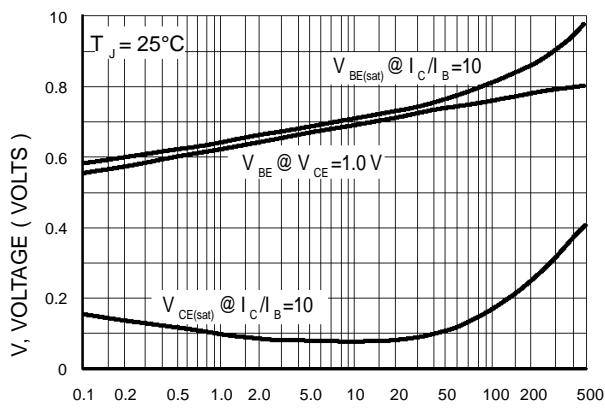

Figure 19. "On" Voltages

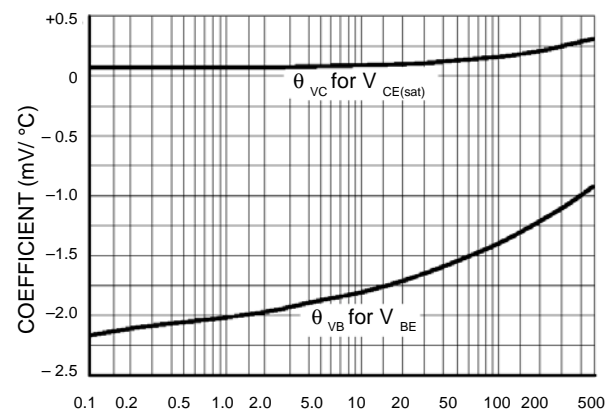
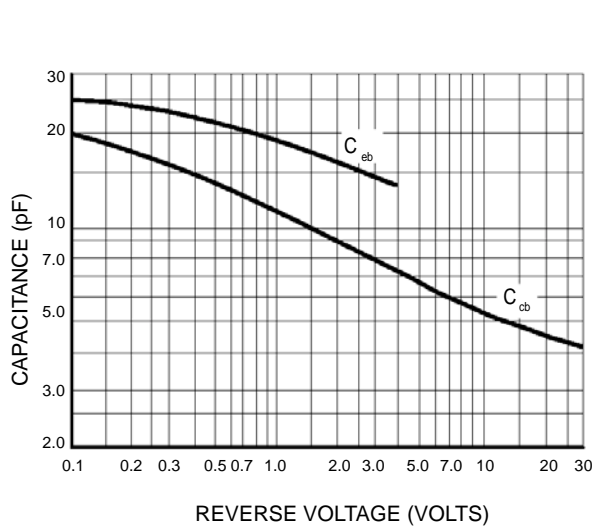

Figure 20. Temperature Coefficients

**LMBT4413DW1T1G;S-LMBT4413DW1T1G**

**TYPICAL TRANSIENT CHARACTERISTICS (Q2 PNP)**



**Figure 3. Capacitance**

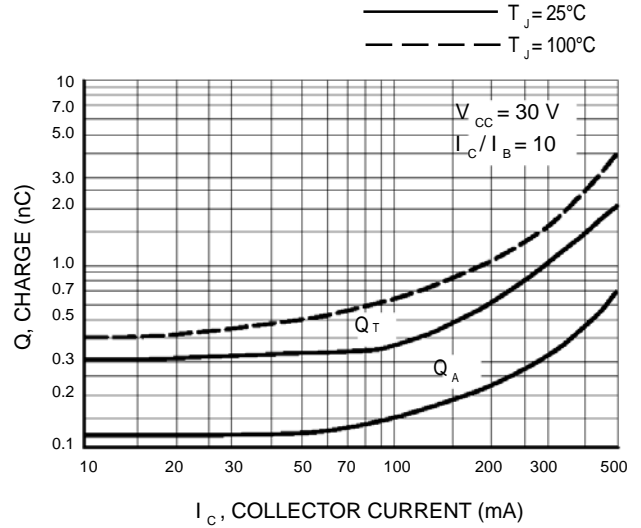

**Figure 4. Charge Data**

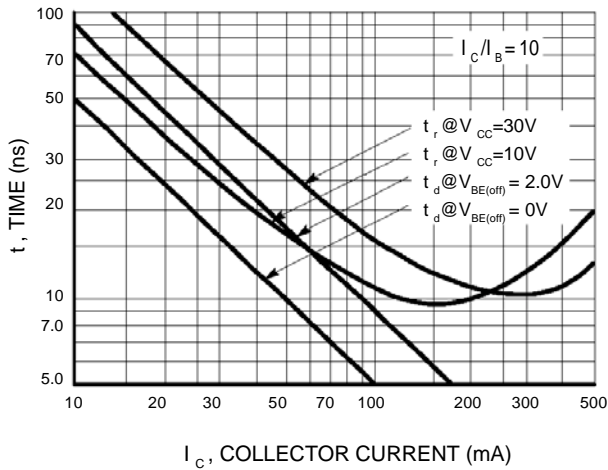

**Figure 5. Turn-On Time**

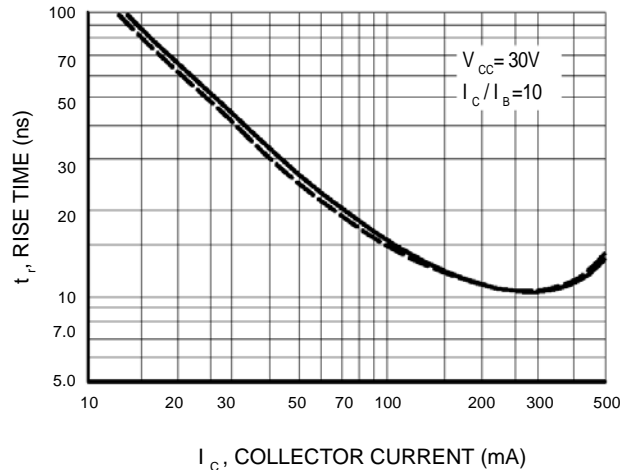

**Figure 6. Rise Time**

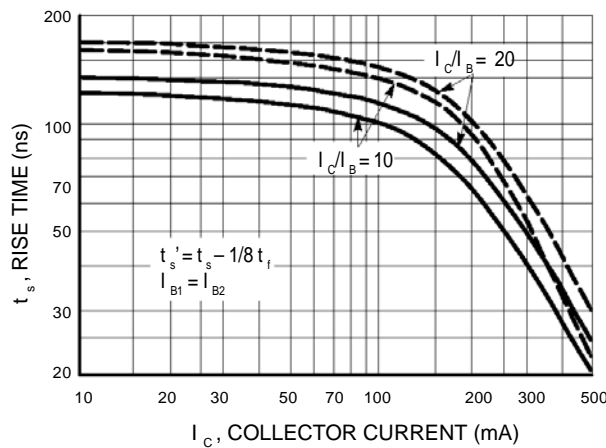

**Figure 7. Storage Time**



# LMBT4413DW1T1G;S-LMBT4413DW1T1G

## SMALL-SIGNAL CHARACTERISTICS (Q2 PNP)

### NOISE FIGURE

$V_{CE} = -10 \text{ Vdc}$ ,  $T_A = 25^\circ\text{C}$   
Bandwidth = 1.0 Hz

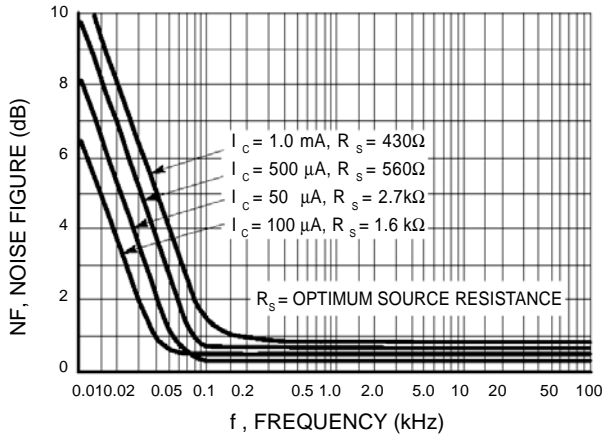

Figure 8. Frequency Effects

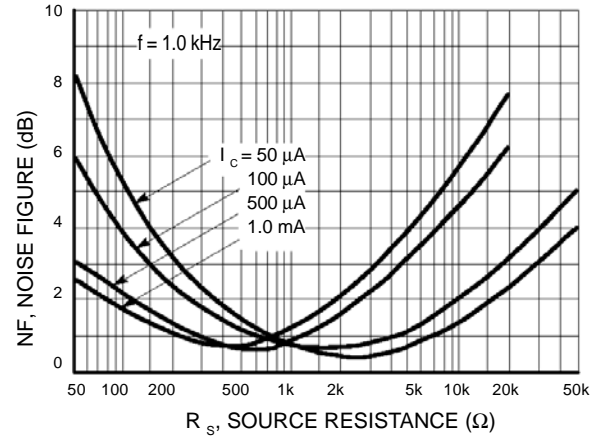

Figure 9. Source Resistance Effects

### h PARAMETERS

( $V_{CE} = -10 \text{ Vdc}$ ,  $f = 1.0 \text{ kHz}$ ,  $T_A = 25^\circ\text{C}$ )

This group of graphs illustrates the relationship between  $h_{fe}$  and other "h" parameters for this series of transistors. To obtain these curves, a high-gain and a low-gain unit were selected from the LMBT4413DW1T1G lines, and the same units were used to develop the correspondingly numbered curves on each graph.

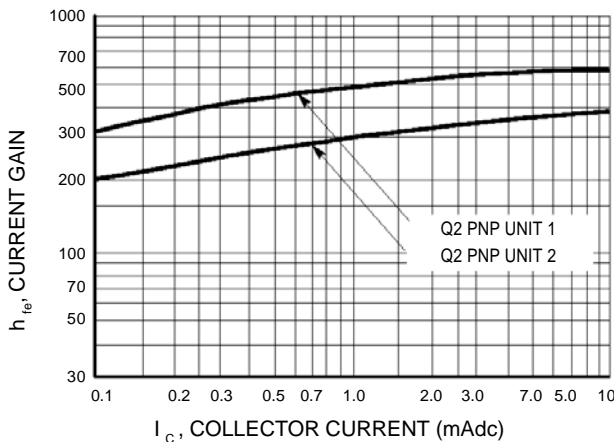

Figure 10. Current Gain

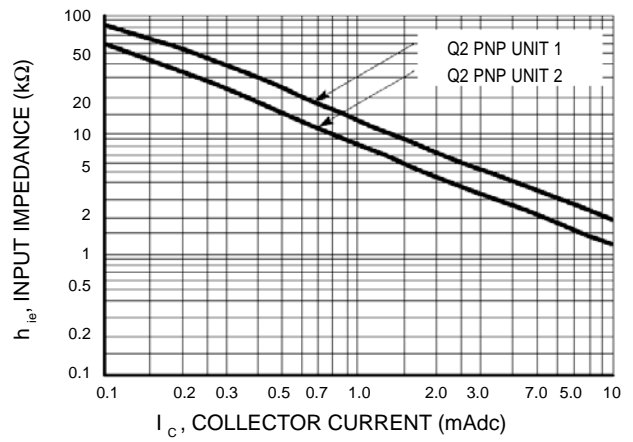

Figure 11. Input Impedance

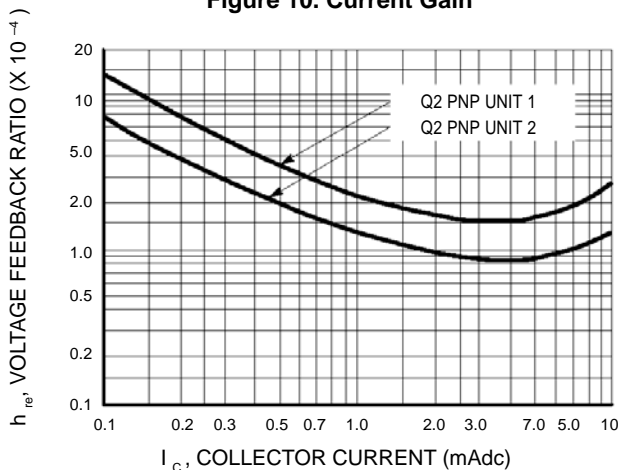

Figure 12. Voltage Feedback Ratio

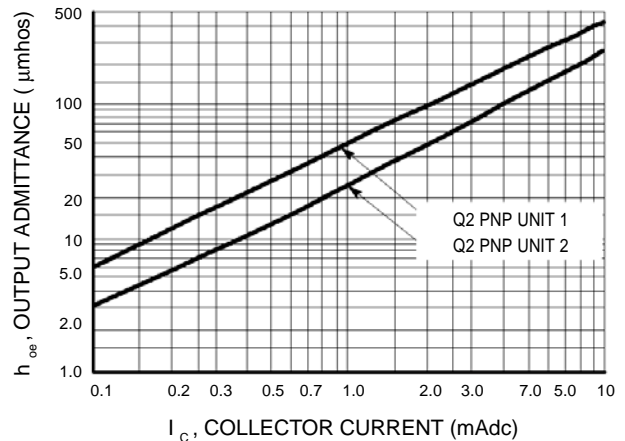
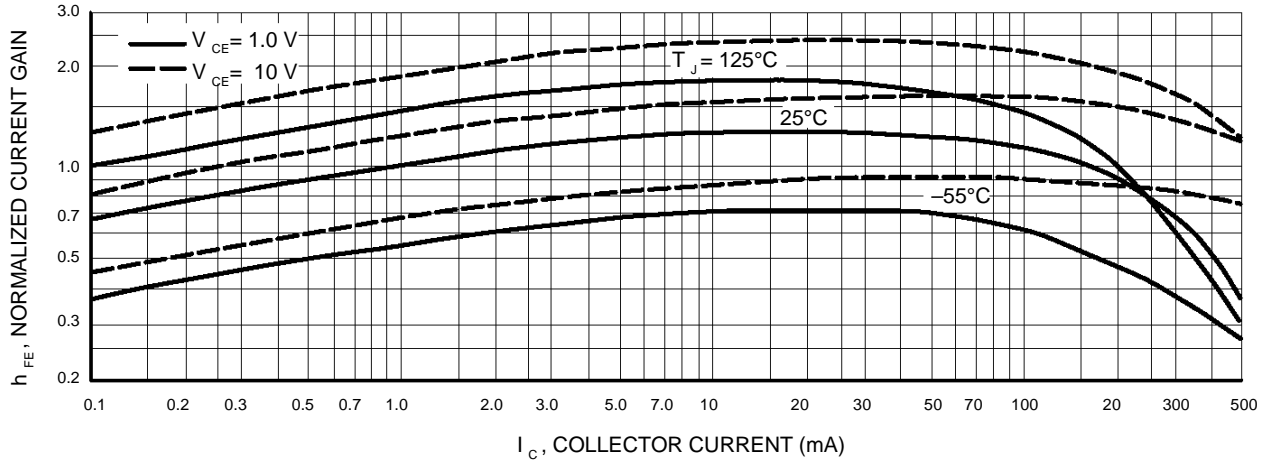

Figure 13. Output Admittance

**LMBT4413DW1T1G;S-LMBT4413DW1T1G**

**STATIC CHARACTERISTICS (Q2 PNP)**



**Figure 14. DC Current Gain**

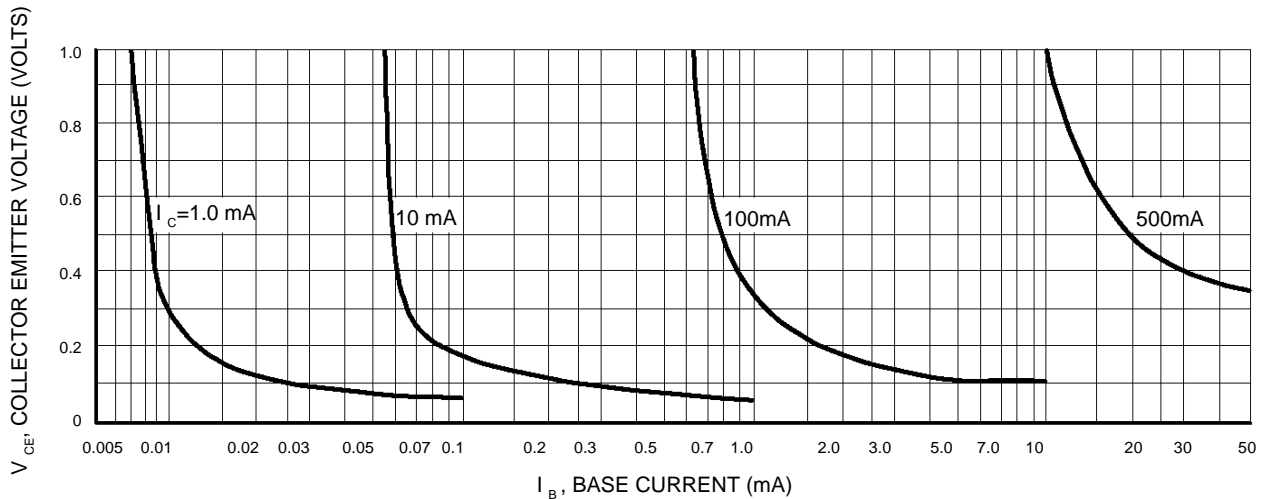

**Figure 15. Collector Saturation Region**

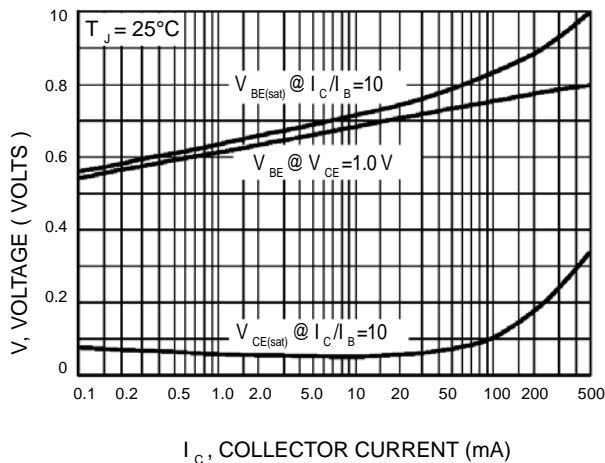

**Figure 16. "On" Voltages**

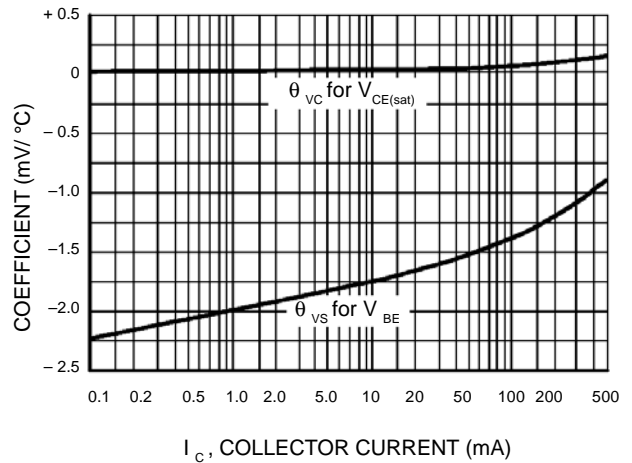

**Figure 17. Temperature Coefficients**

# LMBT4413DW1T1G;S-LMBT4413DW1T1G

SC-88

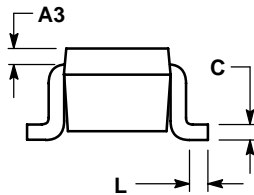
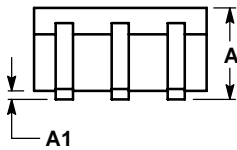
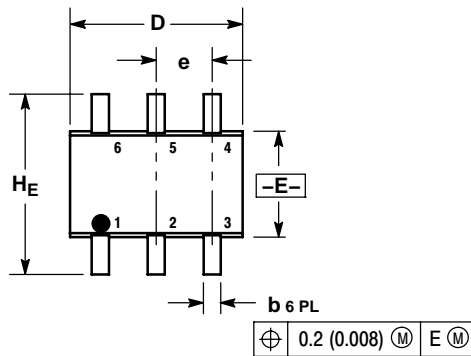

NOTES:

1. DIMENSIONING AND TOLERANCING PER ANSI Y14.5M, 1982.
2. CONTROLLING DIMENSION: INCH.
3. 419B-01 OBSOLETE, NEW STANDARD 419B-02.

DIM	MILLIMETERS			INCHES		
	MIN	NOM	MAX	MIN	NOM	MAX
A	0.80	0.95	1.10	0.031	0.037	0.043
A1	0.00	0.05	0.10	0.000	0.002	0.004
A3	0.20 REF			0.008 REF		
b	0.10	0.21	0.30	0.004	0.008	0.012
C	0.10	0.14	0.25	0.004	0.005	0.010
D	1.80	2.00	2.20	0.070	0.078	0.086
E	1.15	1.25	1.35	0.045	0.049	0.053
e	0.65 BSC			0.026 BSC		
L	0.10	0.20	0.30	0.004	0.008	0.012
HE	2.00	2.10	2.20	0.078	0.082	0.086

**GENERIC MARKING DIAGRAM\***

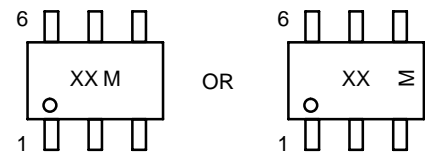

XX = Specific Device Code  
M = Date Code