

200mA Synchronous Rectifier featuring N-MOSFET and Schottky Diode

MTB1K6N06KS6R

Features

- N-MOS with ESD Gate Protection
- N-MOS with Low On-Resistance
- Low V_F Schottky Diode
- Low Static, Switching and Conduction Losses
- Pb-free lead plating and halogen-free package

Equivalent Circuit

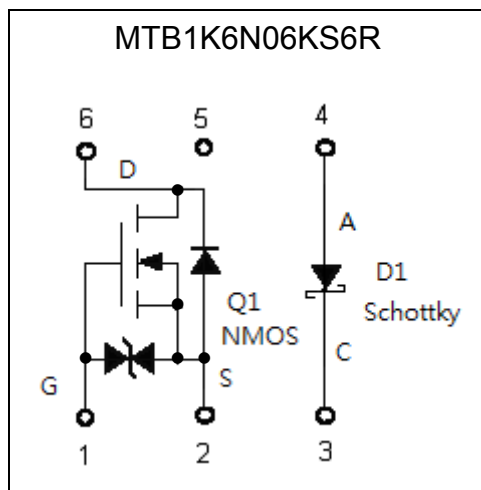

Outline

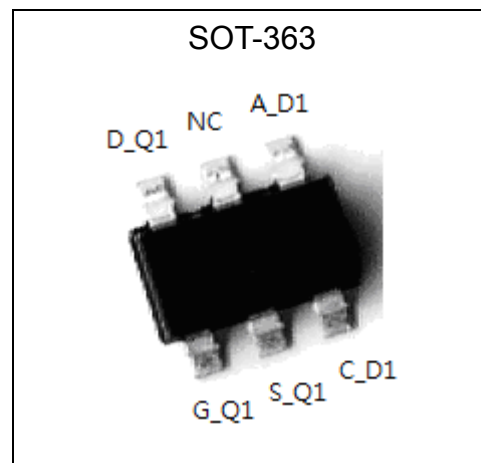

Ordering Information

Device	Package	Shipping
MTB1K6N06KS6R-0-T1-G	SOT-363 (Pb-free lead plating and halogen-free package)	3000 pcs / Tape & Reel

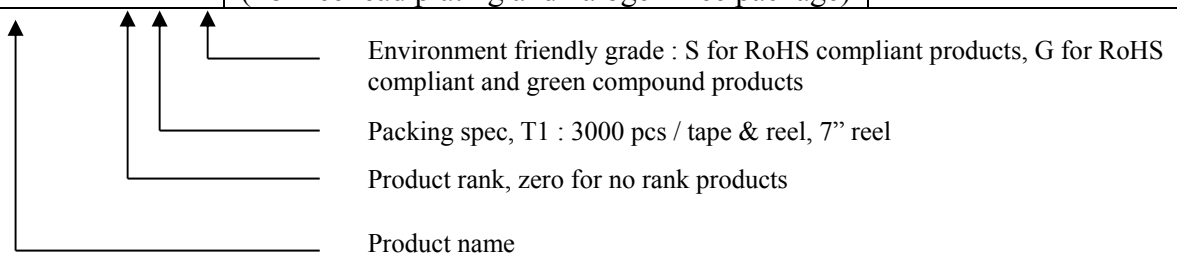

**Absolute Maximum Ratings, Total Device** (Ta=25°C, unless otherwise specified)

Characteristic	Symbol	Value	Unit
Power Dissipation (Note)	P _D	200	mW
Power Derating Factor above 25°C	P _{der}	1.6	mW/°C
Output Current	I _{OUT}	200	mA

Thermal Characteristics

Characteristic	Symbol	Value	Unit
Junction Operation and Storage Temperature Range	T _j ; T _{stg}	-55 ~ +150	°C
Thermal Resistance, Junction to Ambient to Air (Note)	R _{θJA}	625	°C/W

Note : Surface mounted on a FR-4 board with area of 1 in × 0.85 in × 0.062 in copper pad.

Sub-Component Device : ESD Protected N-Channel MOSFET (Q1)

(Ta=25°C, unless otherwise specified)

Characteristic	Symbol	Value	Unit
Drain Source Voltage	V _{DSS}	60	V
Drain Gate Voltage (R _{GS} <1MΩ)	V _{DGR}	60	V
Gate Source Voltage	V _{GSS}	±20	V
Drain Current	Continuous (V _{GS} =10V)	I _D	200
	Pulsed (t _p ≤10μs, Duty Cycle≤1%)	I _{DM}	800
Continuous Source Current	I _S	200	mA

Sub-Component Device : Schottky Diode (D1)

Characteristic	Symbol	Value	Unit
Peak Repetitive Reverse Voltage	V _{RRM}	40	V
Working Peak Reverse Voltage	V _{RWM}		
DC Blocking Voltage	V _R		
RMS Reverse Voltage	V _{R(RMS)}	28	V
Forward Continuous Current	I _{FM}	350	mA
Non-Repetitive Peak Forward Surge Current @ t<1.0s	I _{FSM}	1.5	A



Electrical Characteristics (Tj=25°C, unless otherwise noted)

ESD protected N-Channel MOSFET (Q1) @ TA=25°C, unless otherwise specified

Symbol	Min.	Typ.	Max.	Unit	Test Conditions
Static					
BV _{DSS}	60	-	-	V	V _{GS} =0V, I _D =250μA
ΔBV _{DSS} /ΔT _j	-	0.07	-	V/°C	Reference to 25°C, I _D =250μA
V _{GS(th)}	0.8	1.5	2.3	V	V _{DS} =V _{GS} , I _D =250μA
	0.9	1.7	2.5		V _{DS} =V _{GS} , I _D =1mA
I _{GSS}	-	-	±10	μA	V _{GS} =±20V, V _{DS} =0V
I _{DSS}	-	-	1		V _{DS} =60V, V _{GS} =0V
	-	-	10		V _{DS} =48V, V _{GS} =0V (Tj=70°C)
*R _{DS(ON)}	-	1.8	2.5	Ω	V _{GS} =5V, I _D =50mA
	-	1.5	2		V _{GS} =10V, I _D =500mA
*G _{FS}	-	300	-	mS	V _{DS} =10V, I _D =200mA
Dynamic					
C _{iss}	-	29	50	pF	V _{DS} =25V, V _{GS} =0, f=1MHz
C _{oss}	-	4.3	25		
C _{rss}	-	2.9	5		
t _{d(ON)}	-	2.8	-	ns	V _{DS} =25V, I _D =500mA, V _{GS} =10V R _G =6Ω
t _r	-	16	-		
t _{d(OFF)}	-	7.6	-		
t _f	-	14.4	-		
Q _g	-	2.0	-	nC	V _{DS} =30V, I _D =500mA, V _{GS} =10V
Q _{gs}	-	0.9	-		
Q _{gd}	-	0.7	-		
Source-Drain Diode					
*I _S	-	-	200	mA	
*I _{SM}	-	-	800		
*V _{SD}	-	0.87	1.2	V	V _{GS} =0V, I _S =300mA
*t _{rr}	-	12.3	-	ns	I _F =500mA, dI _F /dt=100A/μs
*Q _{rr}	-	5.6	-	nC	

*Pulse Test : Pulse Width ≤300μs, Duty Cycle≤2%

Schottky Barrier Diode (D1) @ TA=25°C, unless otherwise specified

Characteristic	Symbol	Min	Typ	Max	Unit	Test Conditions
Reverse Breakdown Voltage	V _{(BR)R}	40	-	-	V	I _R =10μA
Forward Voltage Drop	V _{FM}	-	-	0.37	V	I _F =20mA
		-	-	0.6		I _F =200mA
Peak Reverse Current	I _{RM}	-	-	5	μA	V _R =30V
Total Capacitance	C _T	-	41	-	pF	V _R =0V, f=1MHz



Typical Characteristics, total device

Power Derating Curve

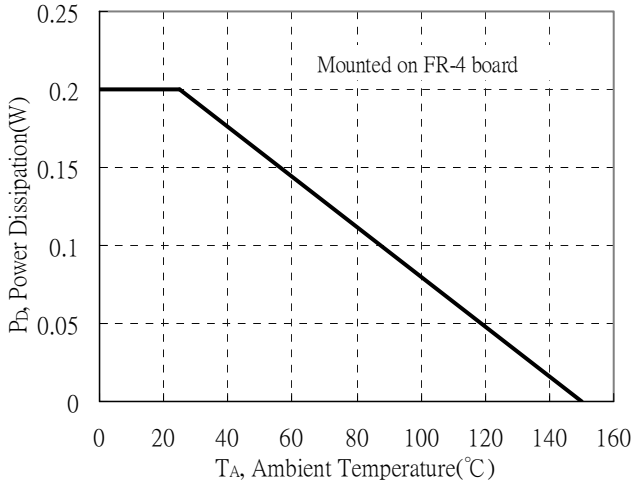

Typical Characteristics, NMOS (Q1)

Typical Output Characteristics

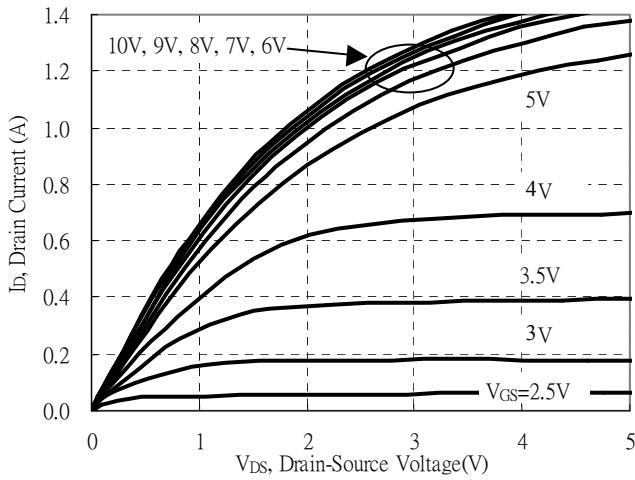

Brekdown Voltage vs Ambient Temperature

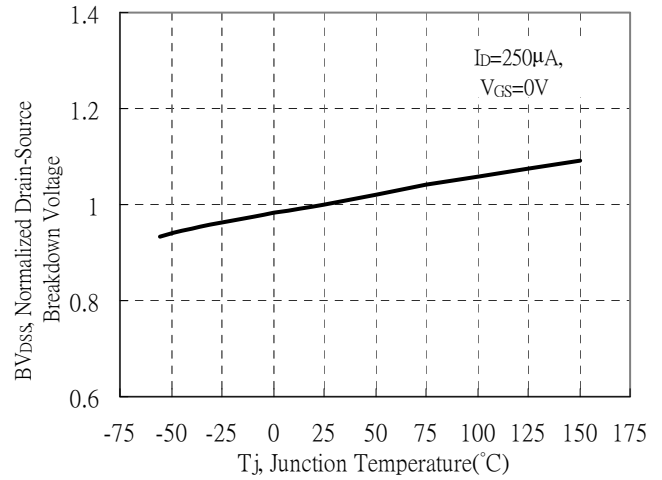

Static Drain-Source On-State resistance vs Drain Current

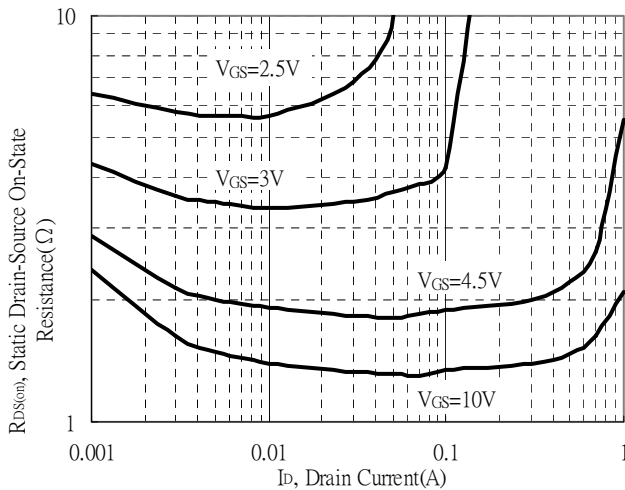

Reverse Drain Current vs Source-Drain Voltage

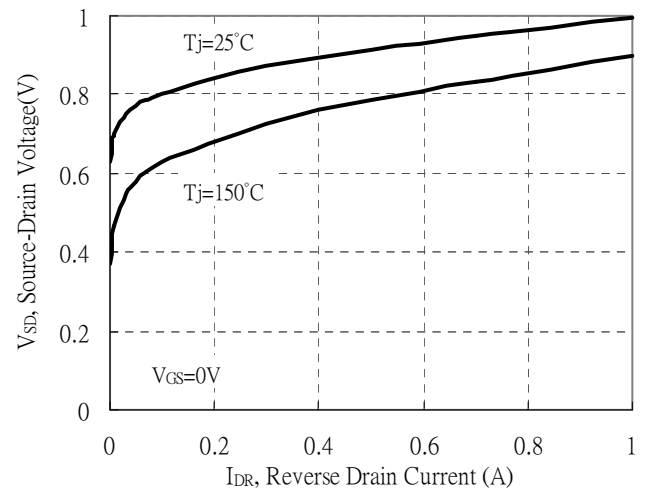



Typical Characteristics(Cont.), NMOS (Q1)

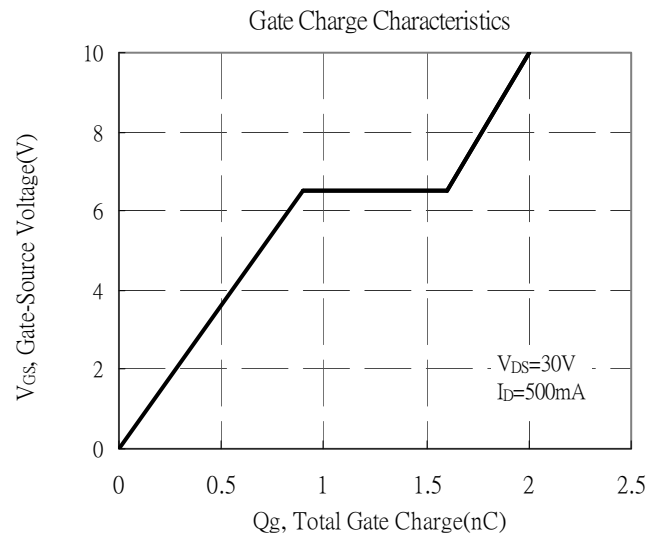
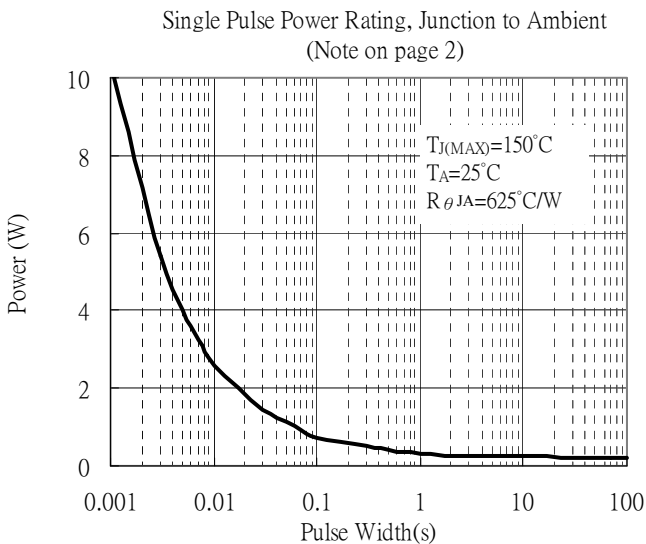
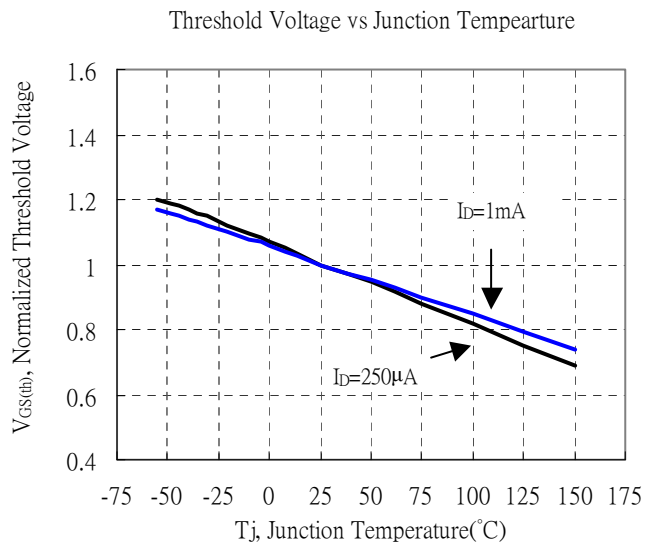
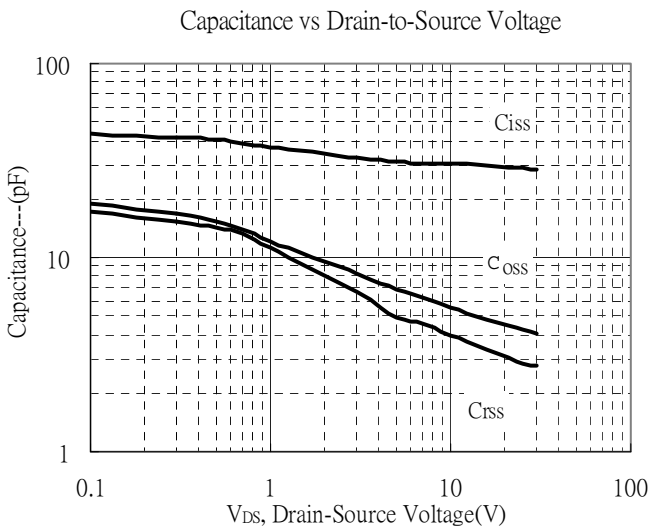
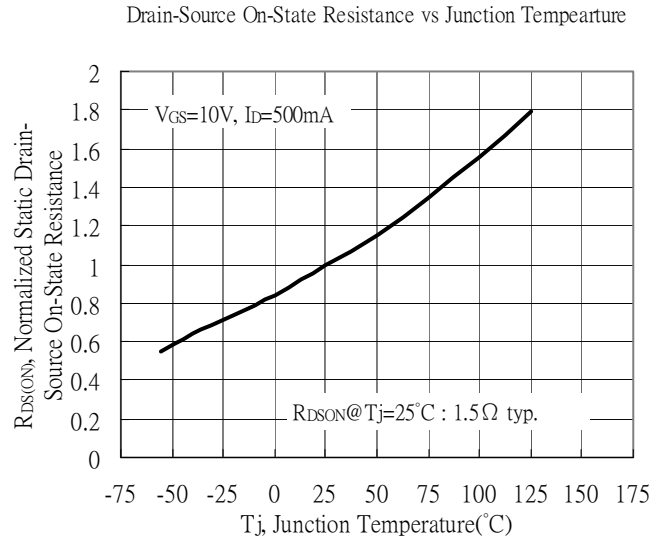
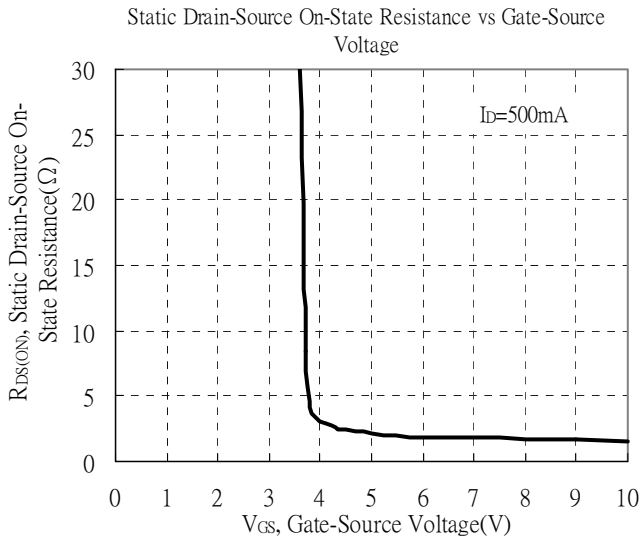



Typical Characteristics(Cont.), NMOS (Q1)

Maximum Safe Operating Area

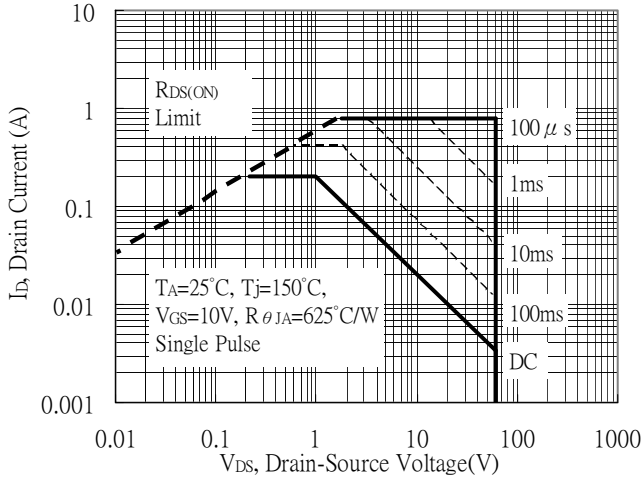

Maximum Drain Current vs Junction Temperature

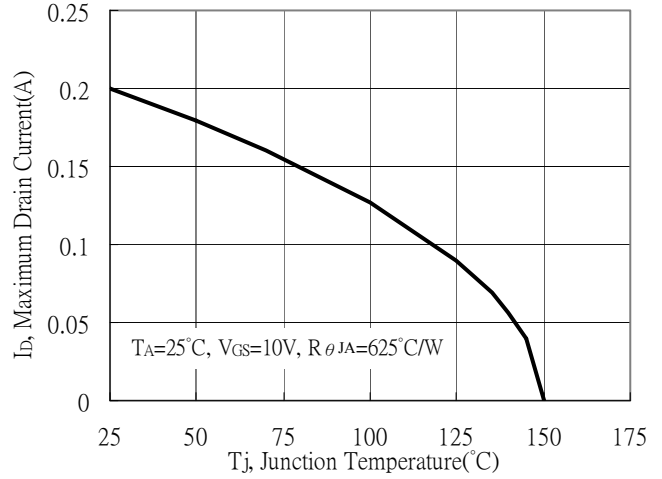

Typical Transfer Characteristics

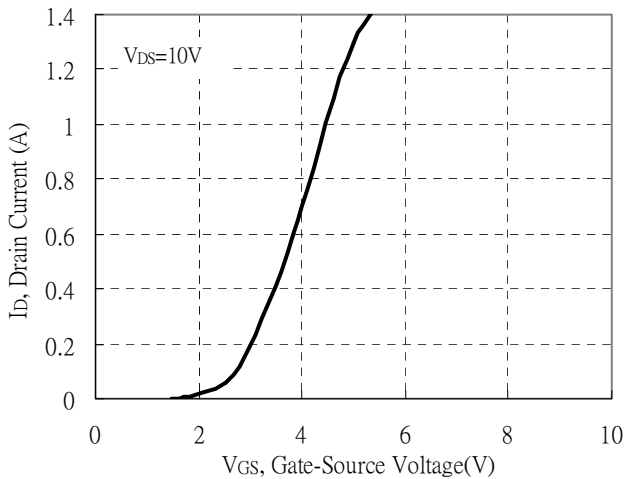

Forward Transfer Admittance vs Drain Current

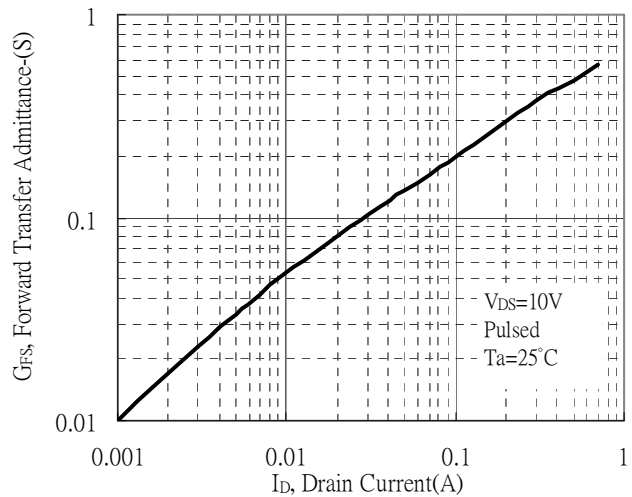

Transient Thermal Response Curves

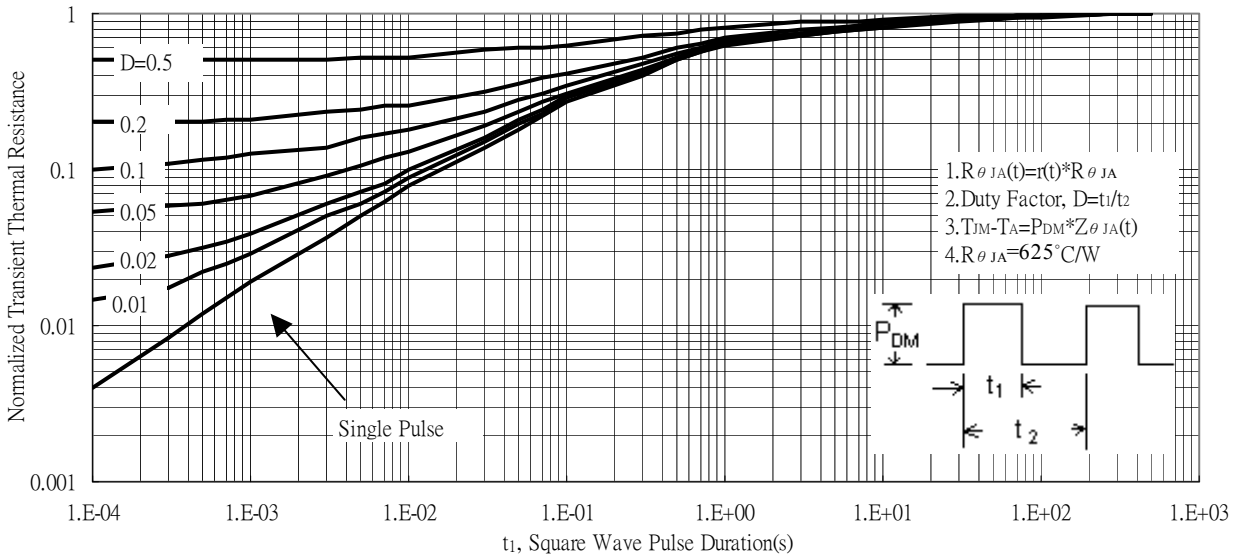



Typical Characteristics, Schottky Barrier Diode (D1)

Forward Current vs Forward Voltage

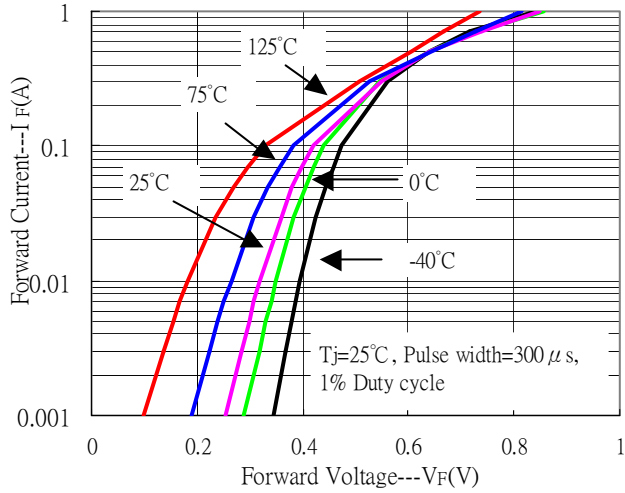

Reverse Leakage Current vs Reverse Voltage

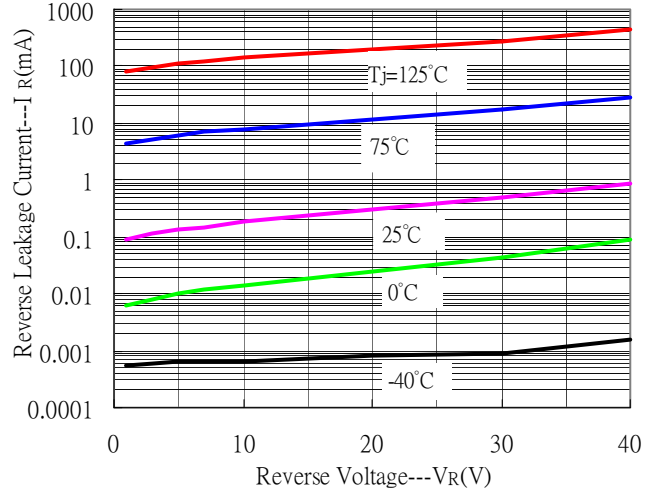

Total Capacitance vs Reverse Voltage

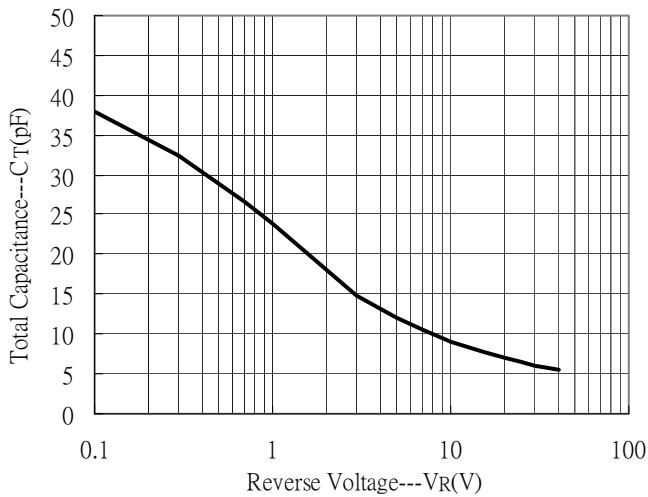

Recommended wave soldering condition

Product	Peak Temperature	Soldering Time
Pb-free devices	260 +0/-5 °C	5 +1/-1 seconds

Recommended temperature profile for IR reflow

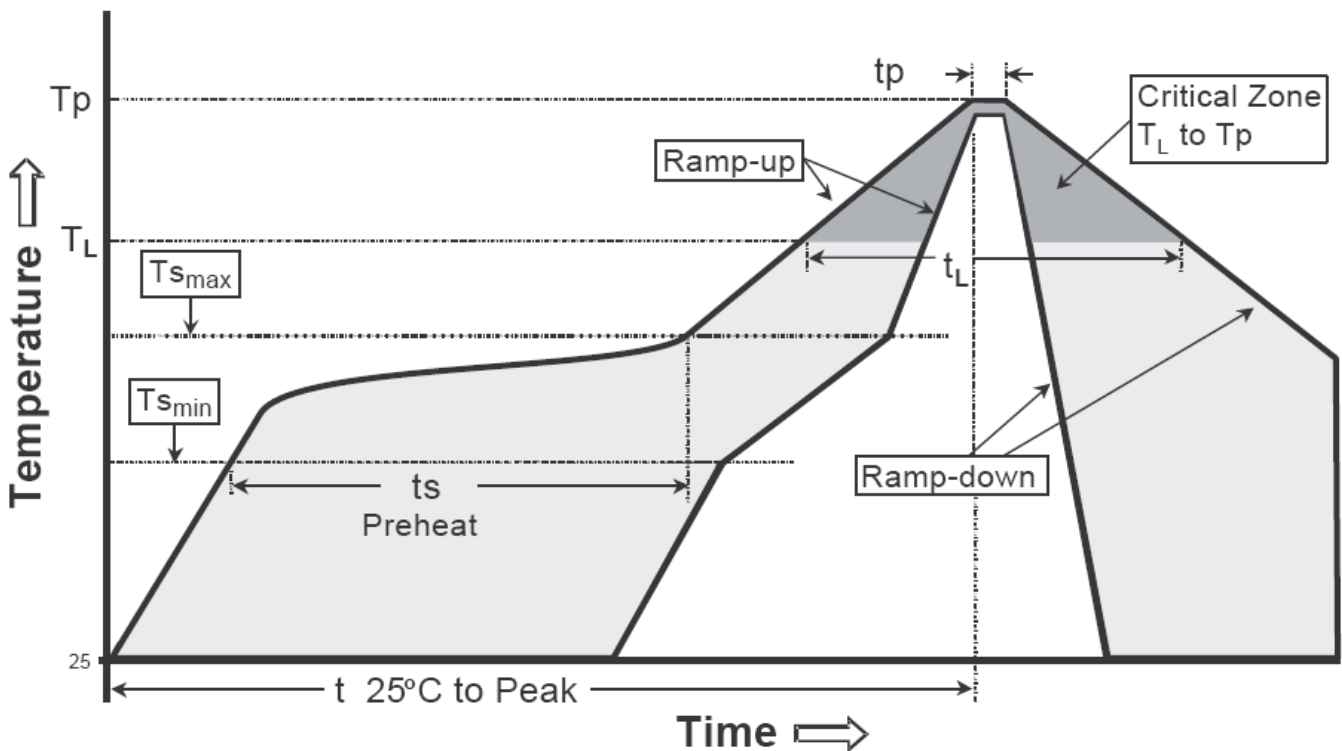

Profile feature	Sn-Pb eutectic Assembly	Pb-free Assembly
Average ramp-up rate (T _{smax} to T _p)	3°C/second max.	3°C/second max.
Preheat		
-Temperature Min(T _{s min})	100°C	150°C
-Temperature Max(T _{s max})	150°C	200°C
-Time(t _{s min} to t _{s max})	60-120 seconds	60-180 seconds
Time maintained above:		
-Temperature (T _L)	183°C	217°C
- Time (t _L)	60-150 seconds	60-150 seconds
Peak Temperature(T _P)	240 +0/-5 °C	260 +0/-5 °C
Time within 5°C of actual peak temperature(tp)	10-30 seconds	20-40 seconds
Ramp down rate	6°C/second max.	6°C/second max.
Time 25 °C to peak temperature	6 minutes max.	8 minutes max.

Note : All temperatures refer to topside of the package, measured on the package body surface.

SOT-363 Dimension

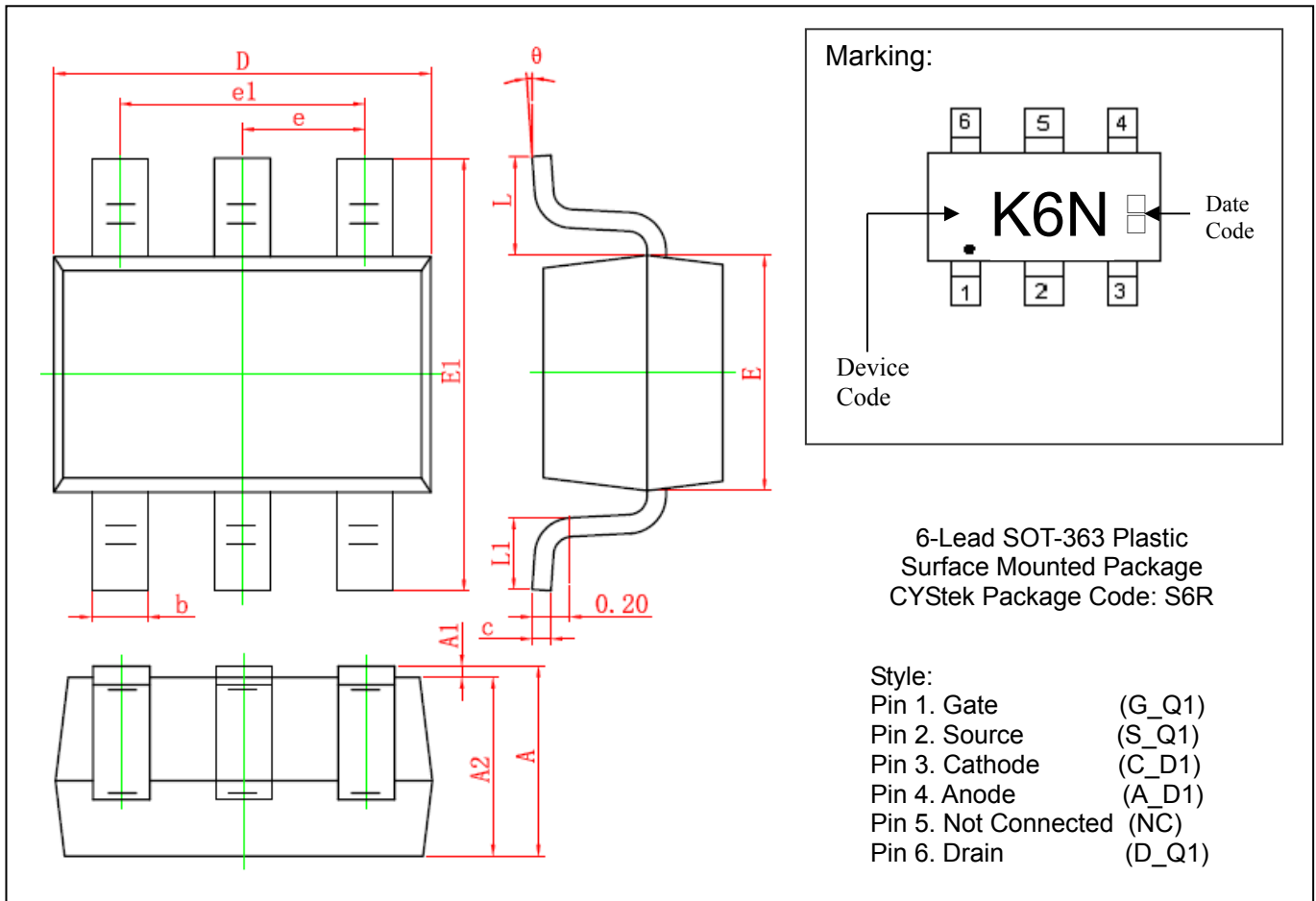

DIM	Millimeters		Inches		DIM	Millimeters		Inches	
	Min.	Max.	Min.	Max.		Min.	Max.	Min.	Max.
A	0.900	1.100	0.035	0.043	E1	2.150	2.450	0.085	0.096
A1	0.000	0.100	0.000	0.004	e	0.650 TYP		0.026 TYP	
A2	0.900	1.000	0.035	0.039	e1	1.200	1.400	0.047	0.055
b	0.150	0.350	0.006	0.014	L	0.525 REF		0.021 REF	
c	0.080	0.150	0.003	0.006	L1	0.260	0.460	0.010	0.018
D	2.000	2.200	0.079	0.087	θ	0°	8°	0°	8°
E	1.150	1.350	0.045	0.053					

Notes : 1.Controlling dimension : millimeters.
 2.Maximum lead thickness includes lead finish thickness, and minimum lead thickness is the minimum thickness of base material.
 3.If there is any question with packing specification or packing method, please contact your local CYStek sales office.

Material :

- Lead : Pure tin plated.
- Mold Compound : Epoxy resin family, flammability solid burning class:UL94V-0.

Important Notice:

- All rights are reserved. Reproduction in whole or in part is prohibited without the prior written approval of CYStek.
- CYStek reserves the right to make changes to its products without notice.
- CYStek **semiconductor products are not warranted to be suitable for use in Life-Support Applications, or systems.**
- CYStek assumes no liability for any consequence of customer product design, infringement of patents, or application assistance.