

Feature:

- Black lens
- Packed in bulk pack (Available in tape/reel)
- High photo sensitivity
- Silicon chip
- Photo transistor
- Daylight filter

Description:

This 3mm photo transistor is ideal for applications that require high sensitivity. This package also comes with daylight filter.

Application:

- Photo copy machines
- Camera
- Printer

Certification & Compliance:

- TS16949
- ISO9001
- RoHS Compliant

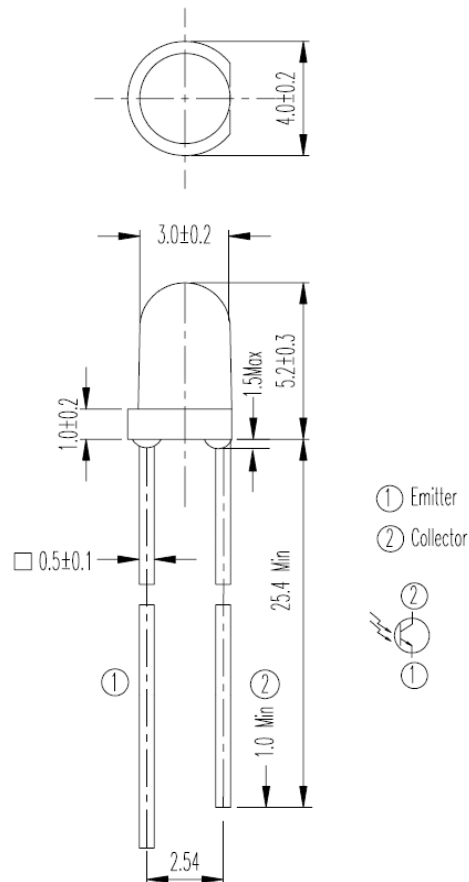
**Dimension:**

Units: mm / tolerance = +/-0.25mm

Electrical / Optical Characteristic (T=25 °C)

Parameter	Symbol	Condition	Min	Typ	Max	Unit
Spectra Bandwidth	$\lambda_{0.5}$	-	760	-	1200	nm
Peak Sensitivity wavelength	λ_P	-	-	940	-	nm
Collector-Emitter Breakdown Voltage	BV_{CEO}	$I_E = 100 \mu A,$ $E_e = 0mW/cm^2,$	30	-	-	V
Emitter-Collector Breakdown Voltage	BV_{ECO}	$I_E = 100 \mu A,$ $E_e = 0mW/cm^2$	5	-	-	V
On state collector current	$I_{C(ON)}$	$E_e = 1mW/cm^2,$ $V_{CE} = 5V$	0.7	2.0	-	mA
Collector dark current	I_{CEO}	$E_e = 0mW/cm^2,$ $V_{CE} = 00V$	-	-	100	nA
Collector-Emitter saturation voltage	$V_{CE(sat)}$	$E_e = 1mW/cm^2,$ $I_C = 2 mA$	-	-	0.4	V
Rise time	t_r	$V_{CE} = 5V$	-	15	-	uS
Fall time	t_f	$R_L = 1000\Omega$ $I_C=1mA$	-	-	-	-

Absolute Maximum Rating:

Part #	Type	P_d (mW)*	V_{CEO} (V)	V_{ECO} (V)	I_C (mA)	T_{OP} (°C)	T_{ST} (°C)	T_{solder} (°C)**
QSC5T120B	Photo Transistor	75	30	5	20	-25 to + 85	-40 to +85	260

* at or below 25 °C

** wave solder for no more than 5 sec @ 260 °C

Characteristic Curves:

Fig.1 Collector Power Dissipation vs. Ambient Temperature

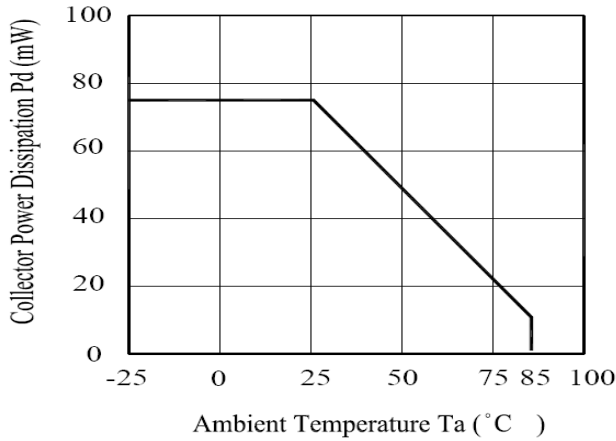

Fig.2 Spectral Sensitivity

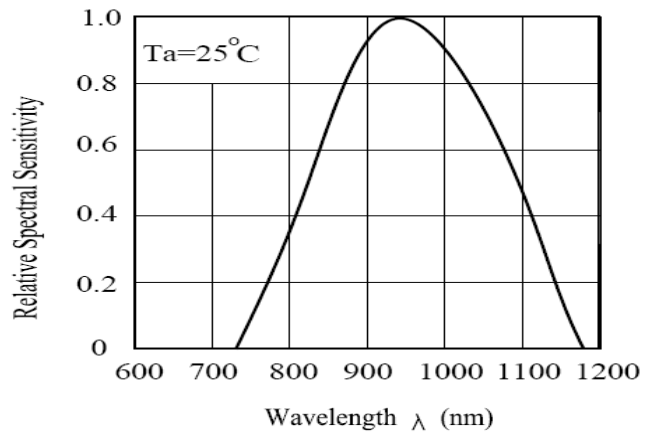

Fig.3 Relative Collector Current vs. Ambient Temperature

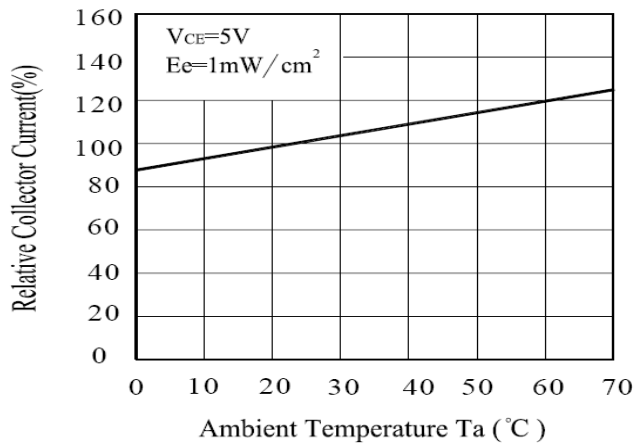

Fig.4 Collector Current vs. Irradiance

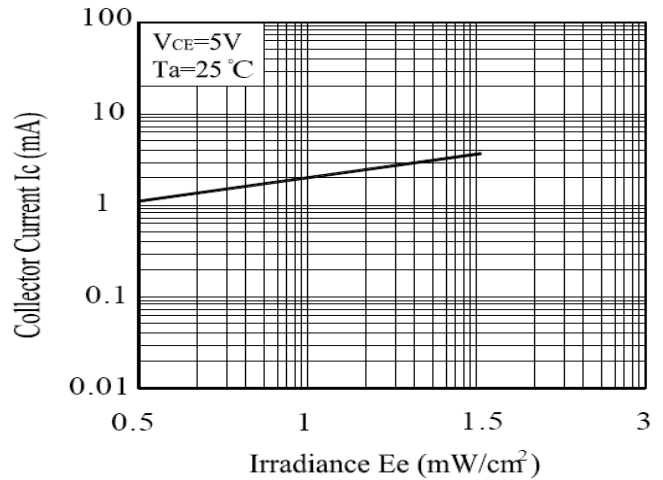

Fig.5 Collector Dark Current vs. Ambient Temperature

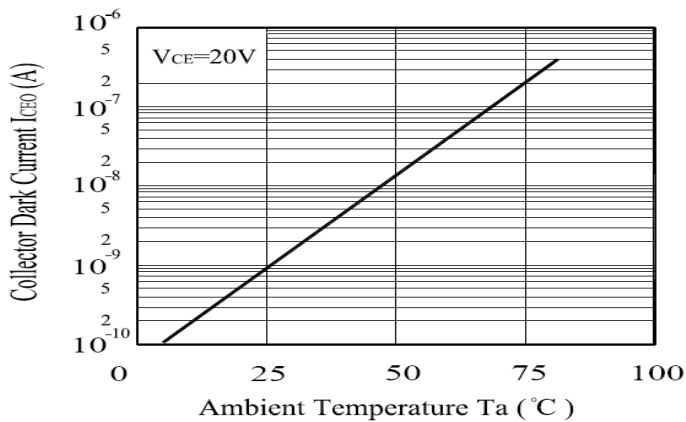
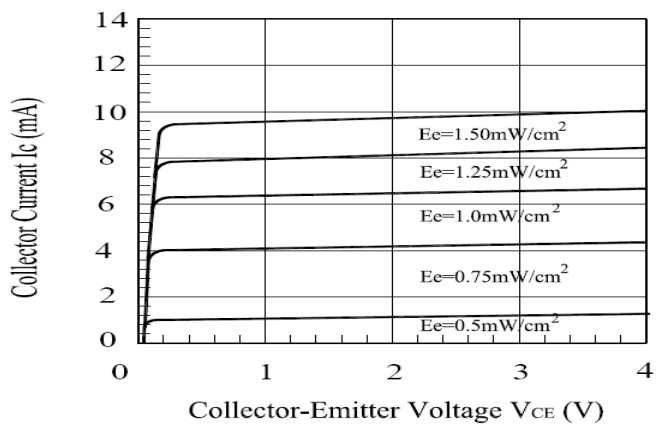
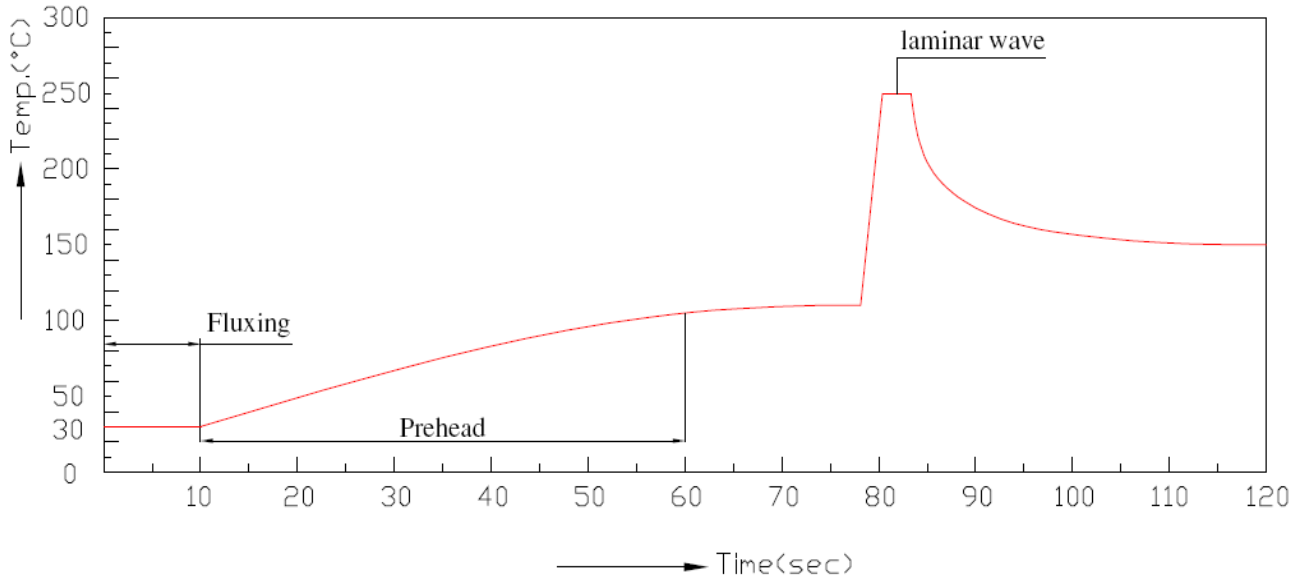

Fig.6 Collector Current vs. Collector-Emitter Voltage



Solder Profile:**Wave Soldering Profile**

DIP Soldering	
Preheat temp.	100°C Max. (60 sec Max.)
Bath temp. & time	260 Max., 5 sec Max
Distance	3mm Min.

Revision History:

Description:	Revision #	Revision Date
New Release of QSC5T120B	V1.0	06/25/2011