

# RF5365

## 2.4GHz to 2.5GHz, 802.11b/g/n WiFi Front End Module

The RF5365 provides an integrated front end solution for WiFi 802.11b/g/n and Bluetooth® systems. The ultra-small form factor package and integrated matching greatly reduces the number of external components and layout area in the customer application. This simplifies the total front end solution by reducing the bill of materials, system footprint, and assembly cost.

The RF5365 integrates a 2.4 GHz Power Amplifier (PA), 2170 MHz notch filter for coexistence with cellular radios, second harmonic attenuation, power detector coupler for improved accuracy, and an SP3T switch capable of simultaneous reception for WiFi and Bluetooth®. The device is provided in a 2.5 mm x 2.5 mm x 0.5 mm, 12-pin package. This module meets or exceeds the RF front end needs of IEEE 802.11b/g/n WiFi RF systems.



Package: QFN, 12-pin,  
2.5mm x 2.5mm x 0.5mm

### Features

- Integrated 2.4GHz to 2.5GHz b/g/n Amplifier, SP3T Switch, and Power Detector Coupler
- Single Supply Voltage 3.0V to 4.8V
- Output Power: 11b = 21dBm Meeting Spectral Mask 11n = 18dBm at <3% EVM
- Low Height Package, Suited for SiP and CoB Designs

### Applications

- Cellular handsets
- Mobile devices
- Tablets
- Consumer electronics
- Gaming
- Netbooks/Notebooks
- TV/monitors/video
- SmartEnergy

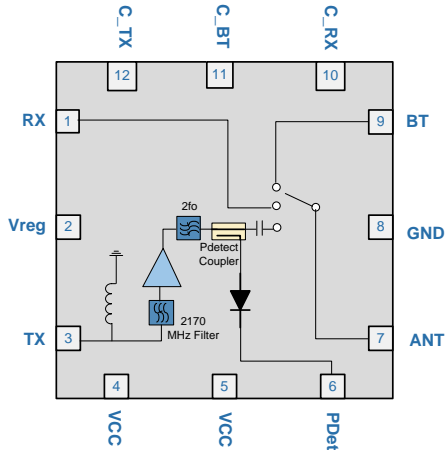

Functional Block Diagram

### Ordering Information

|               |  |
|---------------|--|
| RF5365SQ      | Standard 25 piece bag                          |
| RF5365SR      | Standard 100 piece reel                        |
| RF5365TR7     | Standard 2500 piece reel                       |
| RF5365PCK-410 | Fully assembled evaluation board w/5 piece bag |

## Absolute Maximum Ratings

| Parameter                    | Rating       | Unit |
|------------------------------|--------------|------|
| Supply Voltage               | -0.5 to +5.4 | VDC  |
| Power Control Voltage (VREG) | -0.5 to 3.5  | VDC  |
| DC Supply Current            | 500          | mA   |
| Input RF Power               | +5           | dBm  |
| Operating Case Temperature   | -40 to +85   | °C   |
| Storage Temperature          | -40 to +150  | °C   |
| Moisture Sensitivity         | MSL2         |      |



**Caution!** ESD sensitive device.



RFMD Green: RoHS status based on EU Directive 2011/65/EU (at time of this document revision), halogen free per IEC 61249-2-21, < 1000ppm each of antimony trioxide in polymeric materials and red phosphorus as a flame retardant, and <2% antimony in solder.

Exceeding any one or a combination of the Absolute Maximum Rating conditions may cause permanent damage to the device. Extended application of Absolute Maximum Rating conditions to the device may reduce device reliability. Specified typical performance or functional operation of the device under Absolute Maximum Rating conditions is not implied.

## Nominal Operating Parameters

| Parameter              | Specification        |      |      | Unit | Condition   |   |
|------------------------|----------------------|------|------|------|---|---|
|                        | Min                  | Typ  | Max  |      |   |   |
| <b>Compliance</b>      |                      |      |      |      | <b>IEEE802.11b/g/n Standards; FCC CFG 15.247, .205, .209; EN and JDEC</b>   |   |
| Operating Conditions   |                      |      |      |      | $V_{CC} = 3.0V$ to $4.8V$ ; $V_{REG} = 2.8V$ to $2.9V$ ; Switch Control voltage = $2.7V$ to $3.6V$ ; Temp = $-10^{\circ}C$ to $+70^{\circ}C$ (SPEC COMPLIANT); Temp = $-40^{\circ}C$ to $-10^{\circ}C$ and $+70^{\circ}C$ to $+85^{\circ}C$ (REDUCED PERFORMANCE) |   |
| Frequency Range        | 2.4                  |      | 2.5  | GHz  |   |   |
| Power Supply           | 3.0                  | 3.3  | 4.8  | V    |   |   |
|                        | 2.7                  |      |      | V    | Derated performance   |   |
| VREG Voltage           |                      |      |      |      |   |   |
|                        | ON                   | 2.80 | 2.85 | 2.90 | V   | PA in "ON" state  |
|                        | OFF                  | 0    |      | 0.2  | V   | PA in "OFF" state   |
| Output Power           |                      |      |      |      |   |   |
|                        | 11n                  | 16.5 | 17.0 |      | dBm   | $V_{CC} > 3.0V$ OFDM 54Mbps                               |
|                        | 11n                  | 17.5 | 18.0 |      | dBm   | $V_{CC} > 3.3V$ OFDM 54Mbps                               |
|                        | 11g                  | 18.0 | 18.5 |      | dBm   | $V_{CC} > 3.3V$ OFDM 54Mbps                               |
|                        | 11b                  | 19.5 | 21.0 |      | dBm   | 11 Mbps, CCK, $V_{CC} > 3.3V$                             |
| EVM                    |                      |      |      |      |   |   |
|                        | 11g                  |      | 4.0  | %    | 18dBm, OFDM 54 Mbps, $V_{CC} = 3.3V$ to $4.8V$ all Temp   |   |
|                        | 11n                  |      | 2.5  | 3.0  | %   | 17.5dBm, OFDM 54 Mbps, $V_{CC} = 3.3V$ to $4.8V$ all Temp |
|                        |                      |      | 3.0  | %    | 16.5dBm, OFDM 54 Mbps, $V_{CC} = 3.0V$ VDC all Temp   |   |
| Adjacent Channel Power |                      |      |      |      | $P_{OUT} = 21Bm$ , $V_{CC} = 3.3v$ , 11Mbps CCK signal. See note 2  |   |
|                        | ACP1                 |      | -36  | -33  | dBc   | +/- 11MHz Offset from carrier                             |
|                        | ACP2                 |      | -56  | -52  | dBc   | +/- 22MHz Offset from carrier                             |
| Gain                   | 23                   | 25   | 29   | dB   | At rated $P_{OUT}$  |   |
| Gain Variance Slope    |                      |      |      |      |   |   |
|                        | Channel 40 MHz BW    | -1.0 |      | +1.0 | dB  |   |
|                        | Channel 20 MHz BW    | -0.5 |      | +0.5 | dB  |   |
|                        | Frequency 100 MHz BW | -2   |      | +2   | dB  | In-Band variance 2.4GHz to 2.5GHz                         |
| Out of Band Rejection  |                      |      |      |      |   |   |
|                        | 2170 MHz             | 6    | 8    |      | dBc   | CW signal   |

| Parameter                                 | Specification |      |      | Unit  | Condition  |
|---|---------------|------|------|-------|--|
|   | Min           | Typ  | Max  |       |  |
| <b>Compliance (continued)</b>             |               |      |      |       | <b>IEEE802.11b/g/n Standards; FCC CFG 15.247, .205, .209; EN and JDEC</b>  |
| Output Power Range                        | 0             |      | 23   | dBm   |  |
| Voltage Range                             | 0.1           |      | 1.5  | VDC   |  |
| Voltage at P <sub>OUT</sub> = 18dBm       | 0.6           | 0.65 | 0.7  | dB    | 11g; 50Ω; V <sub>CC</sub> = 3.0V to 4.8 V  |
| Filter Bandwidth                          |               | 0.1  |      | MHz   |  |
| Sensitivity                               |               |      |      |       |  |
| P <sub>DETECT</sub> < 0.5 V               | 10            |      |      | mV/dB |  |
| P <sub>DETECT</sub> > 0.5 V               | 20            |      |      | mV/dB |  |
| Voltage Target at 23 dBm P <sub>OUT</sub> |               | 1.2  |      | V     |  |
| Load Variation                            |               |      | ±200 | mV    | up to 3:1 VSWR   |
| Current Consumption                       |               |      |      |       |  |
| Quiescent                                 |               | 135  | 180  | mA    | V <sub>CC</sub> =3.0V to 4.8 V All Temp  |
| Operating                                 |               | 170  | 220  | mA    | V <sub>CC</sub> < 4.2 V <sub>DC</sub> , P <sub>OUT</sub> = 18dBm, 11 n, 50 W,, Temp=25 °C  |
| Operating                                 |               |      | 230  | mA    | V <sub>CC</sub> < 4.8 V <sub>DC</sub> , P <sub>OUT</sub> = 17.5dBm, 11 n, 50 W,, All Temp  |
| Operating                                 |               | 210  | 270  | mA    | V <sub>CC</sub> < 4.2 V <sub>DC</sub> , P <sub>OUT</sub> = 21dBm, 11b, 50 W, All Temp  |
| V <sub>REG</sub>                          |               | 3    | 5    | mA    | T = 25°C   |
| FEM Leakage                               |               |      | 500  | nA    | V <sub>CC</sub> = "ON", V <sub>REG</sub> = 0.2 V <sub>DC</sub> , RF OFF  |
| V <sub>REG</sub> Leakage                  |               |      | 50   | nA    |  |
| Noise Figure                              |               | 8    | 9    | dB    |  |
| Input Return Loss                         | 8             | 10   |      | dB    |  |
| Thermal Resistance                        |               | 52   |      | °C/W  | V <sub>CC</sub> =4.8V, V <sub>REG</sub> =2.95V, C <sub>TX</sub> =3.3V, C <sub>TX</sub> =3.3, C <sub>RX</sub> =C <sub>BT</sub> =GND, P <sub>OUT</sub> = 18dBm, Modulation=OFDM 11g, Freq=2.45GHz, DC=100%, T=85°C |
| Harmonics                                 |               |      |      |       | P <sub>OUT</sub> = 21dBm, 1 Mbps, CCK BW = 1 MHz, up to 3:1 load   |
| Second                                    |               |      | -15  | dBm   | 4.80 GHz to 5.00 GHz, V <sub>CC</sub> = 3.3 V, Temp=25°C   |
| Third                                     |               |      | -20  | dBm   | 7.20 GHz to 7.50 GHz, V <sub>CC</sub> = 3.3 V, Temp=25°C   |
| Stability                                 |               |      |      |       | PA must be stable from 0dBm to 21dBm. CW Signal, No spurs above -41.25dBm for non-harmonic related signals.  |
| Output VSWR                               | 4:1           |      |      |       | All phase angles, no spurious or oscillations.   |
| Ruggedness                                |               |      |      |       | No Damage Conditions over Voltage and Temperature  |
| Output VSWR                               | 10:1          |      |      |       |  |
| Input Power                               |               |      | 0    | dBm   | CW Input Power, V <sub>CC</sub> = 3.0 V to 4.8 V   |
| Input Port Impedance                      |               | 50   |      | Ω     |  |
| Turn-On/Off Time                          |               |      | 1    | usec  | Output stable to within 90% of final gain  |
| <b>2.4GHz Receive</b>                     |               |      |      |       |  |
| Frequency                                 | 2.4           |      | 2.5  | GHz   | Frequency  |
| Insertion Loss                            |               | 0.8  | 1.2  | dB    | Insertion Loss   |
| Input P1dB                                | 22            |      |      | dBm   | Input P1dB   |
| Passband Ripple                           |               |      |      |       | Passband Ripple  |
| WiFi RX Mode                              | -0.2          |      | +0.2 | dB    | WiFi RX Mode   |
| WiFi RX/BT Mode                           | -0.2          |      | +0.2 | dB    | WiFi RX/BT Mode  |
| WiFi RX Port Return Loss                  | 10            | 12   |      | dB    | WiFi RX Port Return Loss   |
| WiFi RX Port Impedance                    |               | 50   |      | Ω     | WiFi RX Port Impedance   |

| Parameter                  | Specification |     |     | Unit | Condition                            |
|----------------------------|---------------|-----|-----|------|--------------------------------------|
|                            | Min           | Typ | Max |      |                                      |
| <b>Bluetooth®</b>          |               |     |     |      |                                      |
| Frequency                  | 2.4           |     | 2.5 | GHz  |                                      |
| Insertion Loss             |               | 0.8 | 1.2 | dB   |                                      |
| Bluetooth Port Return Loss | 10            | 12  |     | dB   |                                      |
| Bluetooth Port Impedance   |               | 50  |     | Ω    |                                      |
| Bluetooth Input P1dB       | 22            |     |     | dBm  |                                      |
| <b>Other Requirements</b>  |               |     |     |      |                                      |
| Antenna Port Impedance     |               | 50  |     | W    |                                      |
| Return Loss                | 10            | 12  |     | dB   | In WiFi RX or BT Mode                |
| Isolation                  |               |     |     |      |                                      |
| ANT to RX                  | 20            |     |     | dB   | At rated P <sub>OUT</sub> in TX Mode |
| Switch Control Voltage     |               |     |     |      |                                      |
| Low                        | 0             |     | 0.2 | V    |                                      |
| High                       | 2.7           |     | 3.6 | V    |                                      |
| Switch Control Current     |               |     |     |      |                                      |
| Low                        |               |     | 0.5 | uA   |                                      |
| High                       |               |     | 100 | uA   |                                      |
| <b>ESD</b>                 |               |     |     |      |                                      |
| Human Body Model           | 1000          |     |     | V    | Pin - Ground                         |
| Charge Device Model        | 500           |     |     | V    | JESD22-C101C. Class III              |

Note 1: The PA must operate with gates bias voltage input at 1% to 99% duty cycle.

Note 2: The output power for channels 1 and 11 may be reduced to meet FCC restricted band requirements.

## Switch Control Logic Truth Table

| Mode         | C_TX | C_RX | C_BT | VREG |
|--------------|------|------|------|------|
| TX Mode      | High | Low  | Low  | High |
| RX Mode      | Low  | High | Low  | Low  |
| BT Mode      | Low  | Low  | High | Low  |
| Simultaneous | Low  | High | High | Low  |

Performance Plots

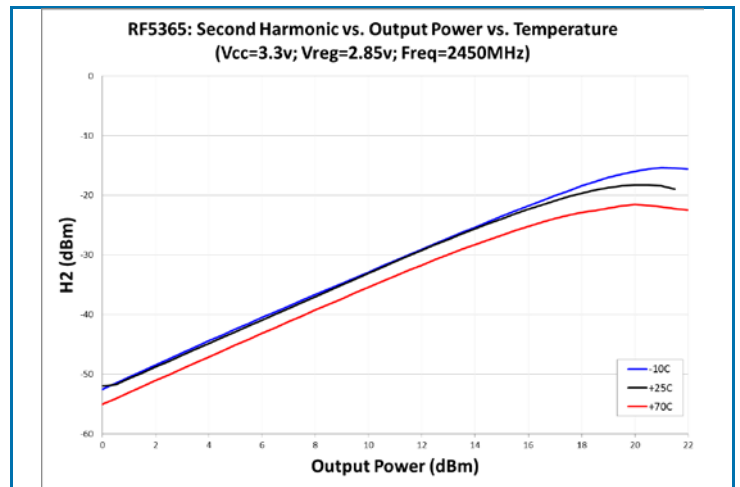
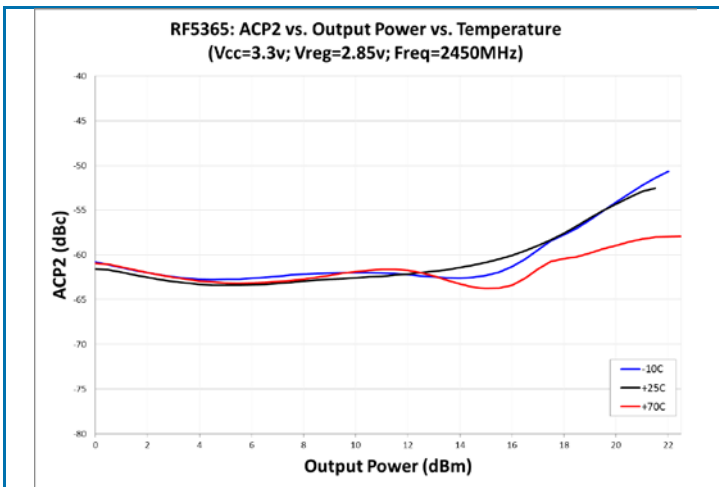
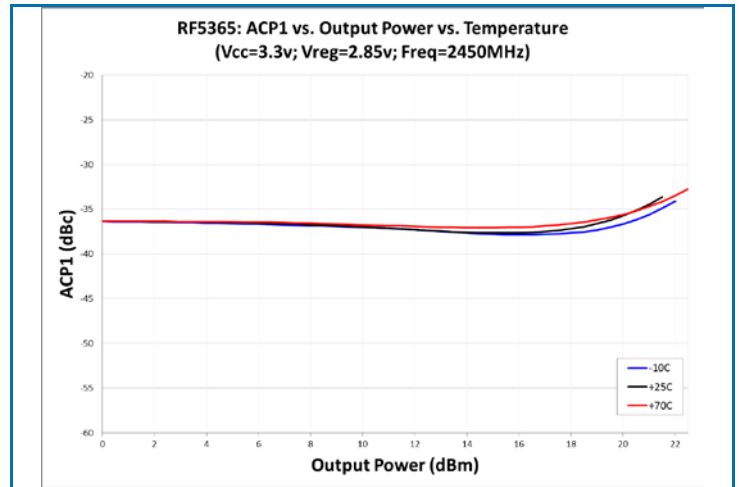
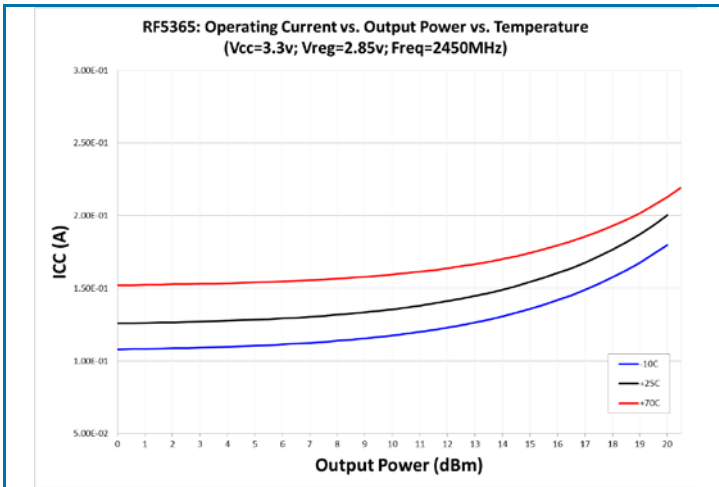
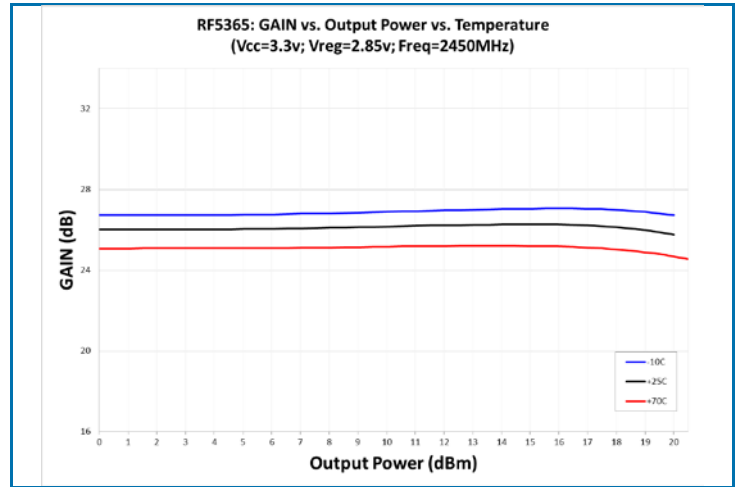
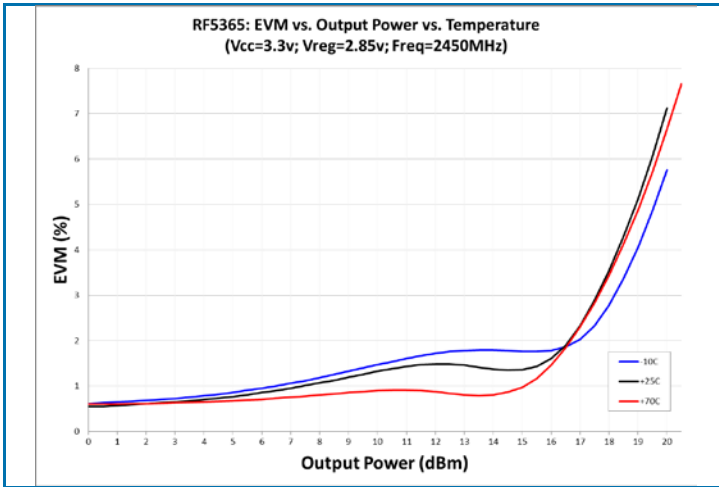

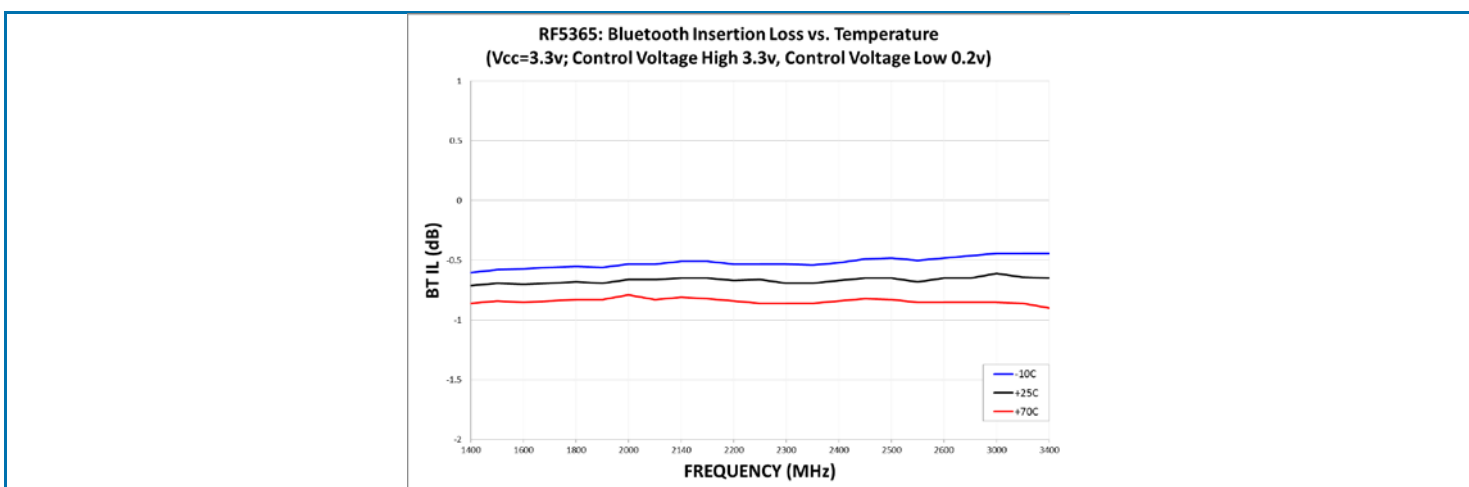
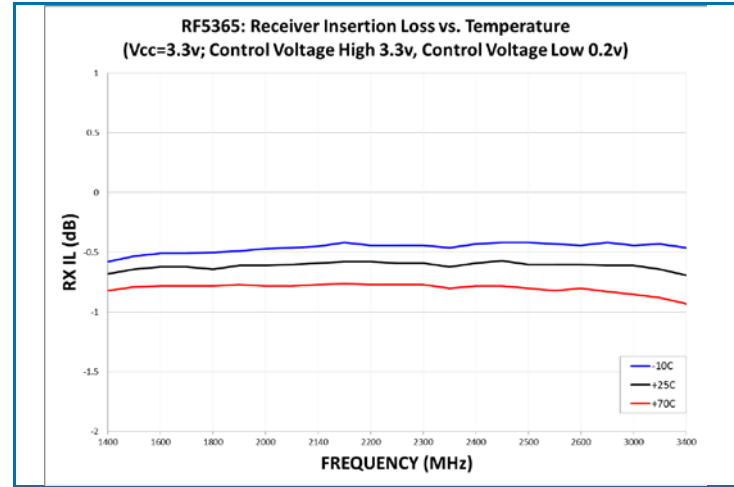
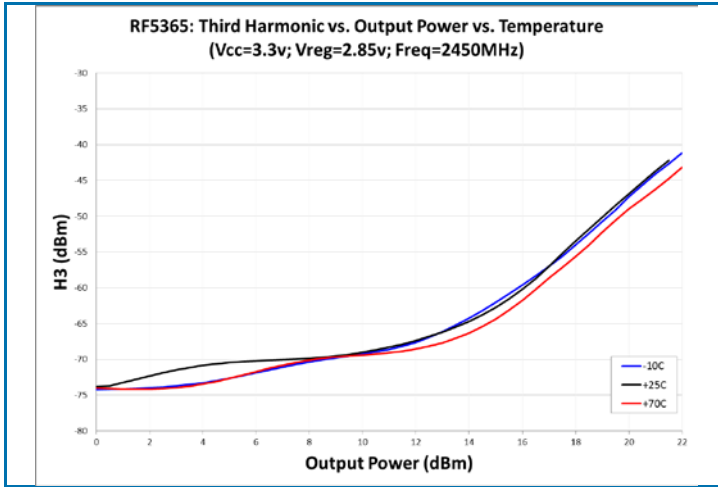

## Evaluation Board Schematic

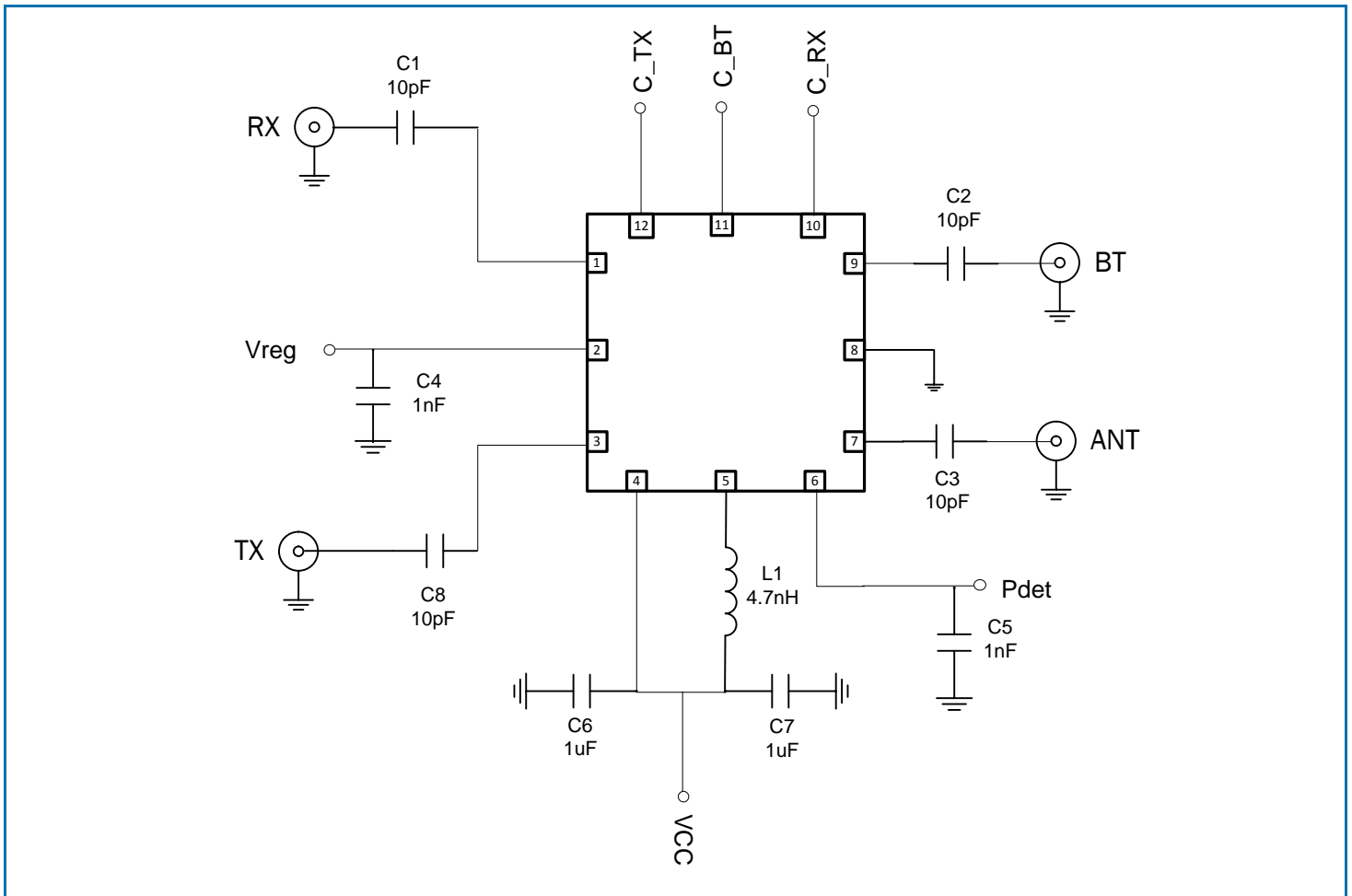

Note: Components C5, and C6 may not be needed in the final schematic. This will be dependent on board layout and noise coupling to these pins. TX input connects directly to the transceiver. If no DC is present on this pin, C8 may also be eliminated.

## Evaluation Board Layout

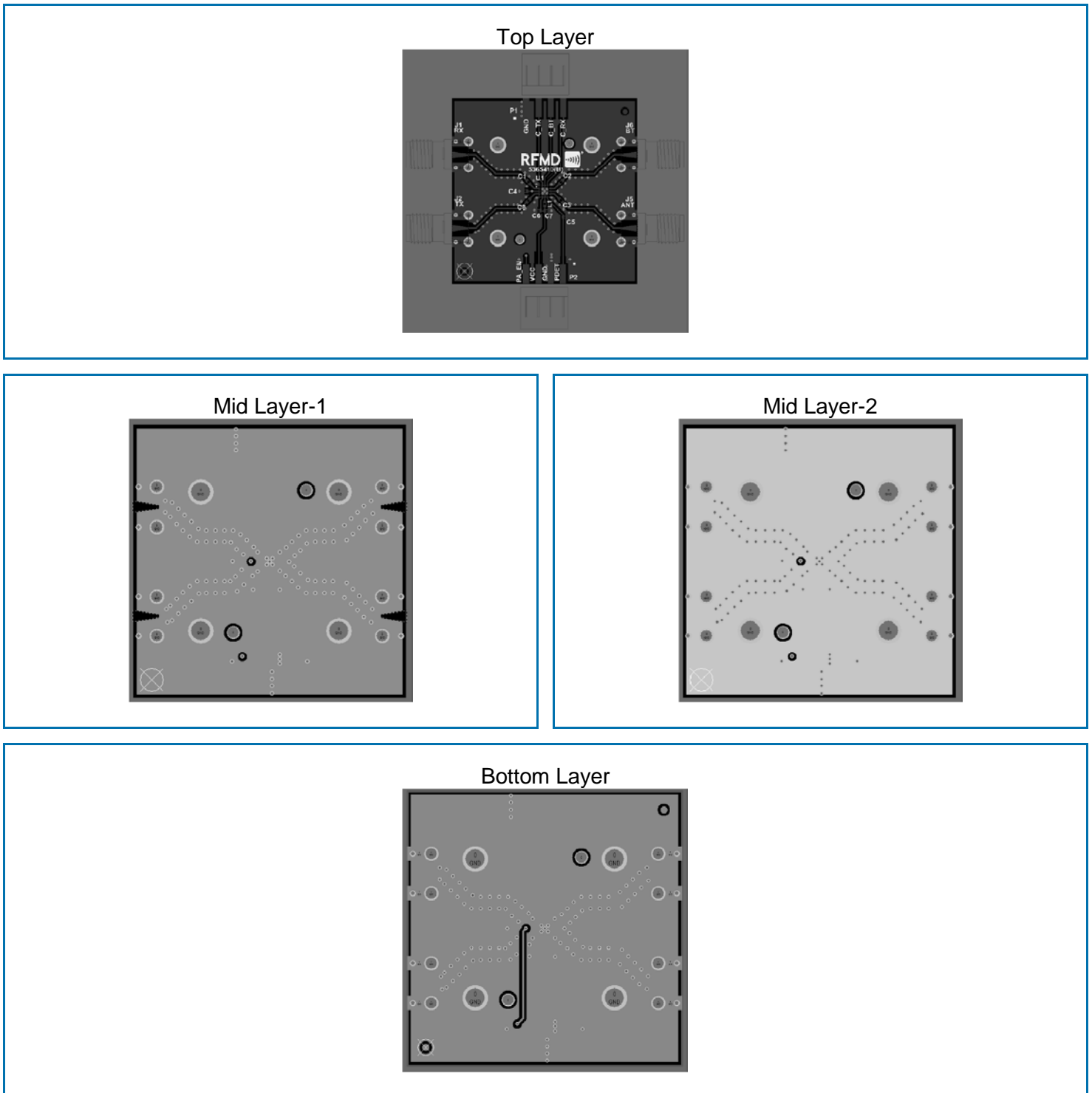

Note: For best performance, it is recommended to follow the routing and grounding of the RFMD evaluation board as close as possible. At a minimum, use five ground thermal vias on the package center slug (via size: 12mil hole by 21mil capture pad)



### Pin Out

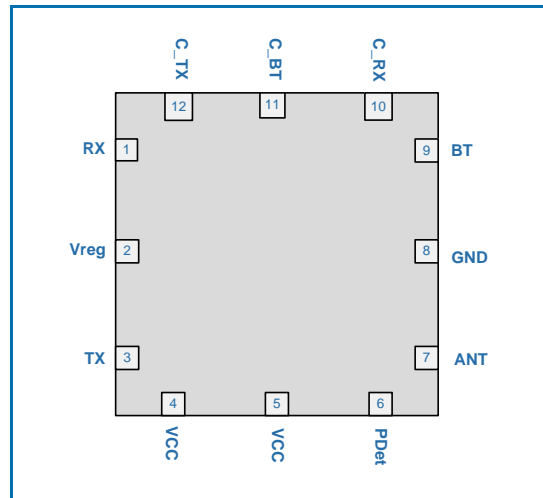

### Package Outline Drawing

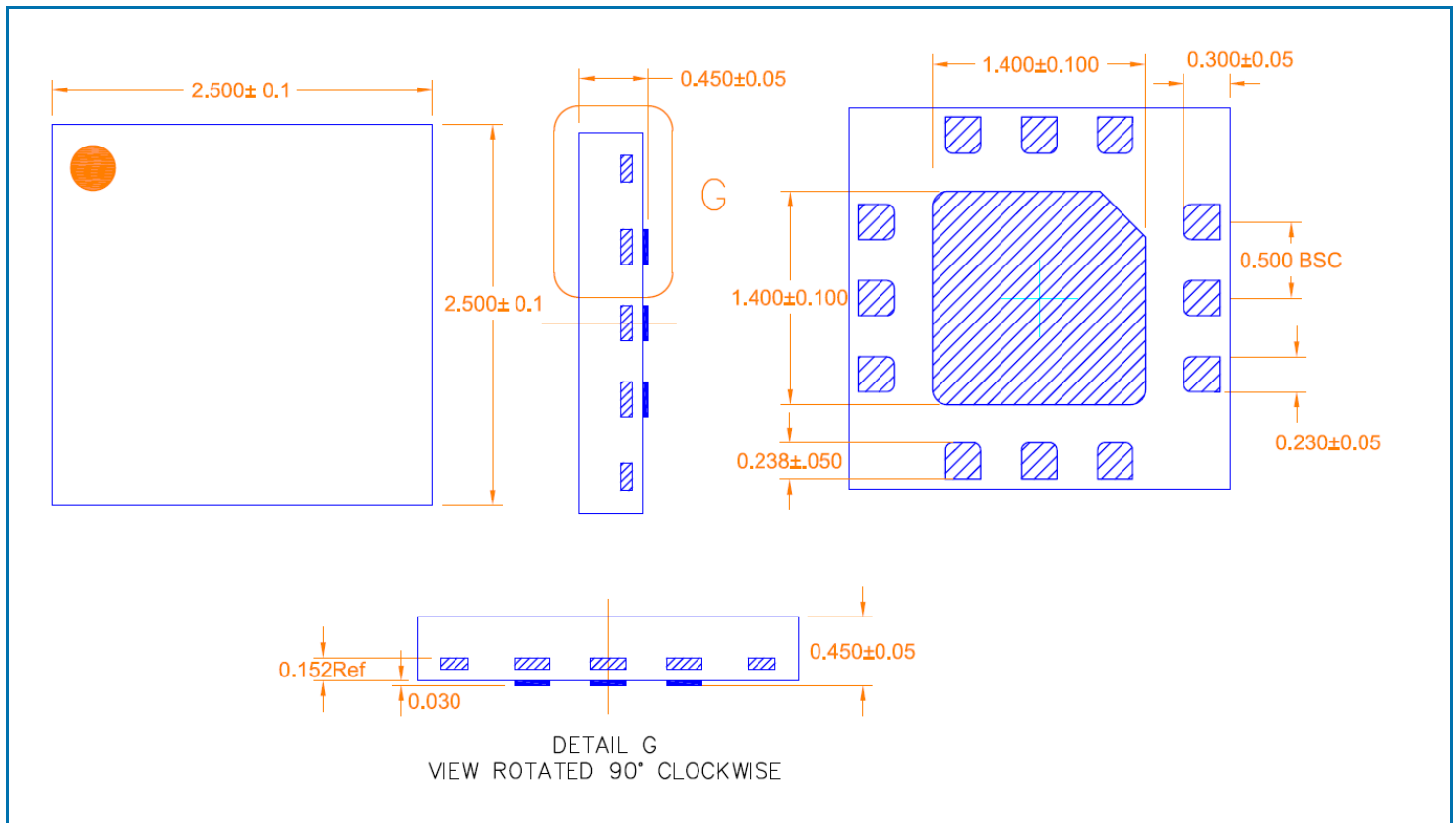

- Note:
1. Pin 1 indicator shaded area
  2. Chamfered area is Pin 1 indicator

## PCB Recommendations

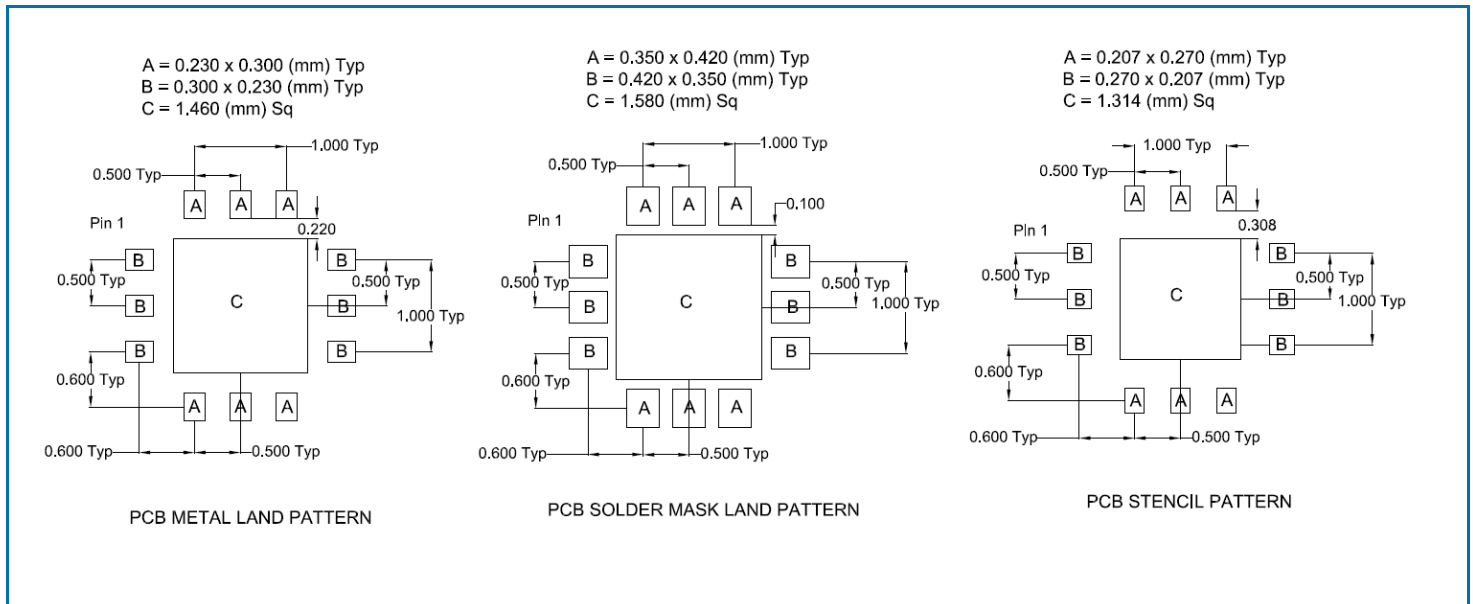

PCB land patterns for RFMD components are based on IPC-7351 standards and RFMD empirical data. The pad pattern shown has been developed and tested for optimized assembly at RFMD. The PCB land pattern has been developed to accommodate lead and package tolerances. Since surface mount processes vary from company to company, careful process development is recommended.

Thermal vias for center slug "B" should be incorporated into the PCB design. The number and size of thermal vias will depend on the application. Example of the number and size of vias can be found on the RFMD evaluation board layout.

## Pin Names and Descriptions

| Pin      | Name         | Description   |
|----------|--------------|---|
| 1        | RX OUT       | Receive port for 802.11b/g/n band. Internally matched to 50Ω. DC block required.  |
| 2        | VREG         | Regulated voltage for the PA bias control circuit. An external bypass capacitor may be needed on the VREG line for decoupling purposes.   |
| 3        | TX IN        | RF input for the 802.11b/g/n PA. Input is matched to 50Ω. DC block required.  |
| 4        | VCC          | Supply voltage for the FEM. Power down pin. Apply $<0.6 V_{DC}$ to power down the power amplifier stages. Apply $2.5 V_{DC}$ to $3.6 V_{DC}$ to power up. If function is not desired, pin may be connected to $V_{CC}$ or $V_{REG}$ . |
| 5        | VCC          | Supply voltage for the FEM.   |
| 6        | POWER DETECT | Power detector voltage for TX section. $P_{DET}$ voltage varies with output power. May need external decoupling.  |
| 7        | ANT          | Port matched to 50Ω. DC block required.   |
| 8        | GND          | Ground connection.  |
| 9        | BT PORT      | Bluetooth® RF Port. DC block required.  |
| 10       | C_RX         | Control pin for WiFi Receive Port. Please see truth table for proper settings.  |
| 11       | C_BT         | Control pin for Bluetooth® Port. Please see truth table for proper settings.  |
| 12       | C_TX         | Control pin for WiFi Transmit Port. Please see truth table for proper settings.   |
| Pkg Base | GND          | Ground connection. The backside of the package should be connected to the ground plane through a short path, i.e., PCB vias under the device are recommended.   |