

# HTS4A60H/HTS4A80H

## 3 Quadrants Standard TRIAC

### FEATURES

- ❑ Repetitive Peak Off-State Voltage : 600V/800V
- ❑ R.M.S On-State Current ( $I_{T(RMS)} = 4A$ )
- ❑ Gate Trigger Current : 25mA
- ❑ High commutation capability.

### Applications

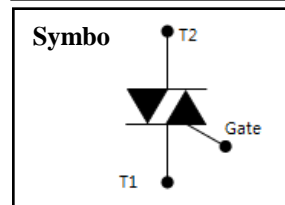
General purpose of AC switching, heating control, motor control, Humidifier, etc

### General Description

Semihow's standard TRIAC product is a glass passivated device, has a high commutative performance, stable gate triggering level to temperature and high off state voltage. It is generally suitable for power and phase control in ac application

### Absolute Maximum Ratings ( $T_J=25^\circ\text{C}$ unless otherwise specified )

$V_{DRM} = 600V/800V$
$I_{T(RMS)} = 4 A$
$I_{TSM} = 42 A$
$I_{GT} = 25mA$



Symbol	Parameter	Conditions	Ratings		Unit
			HTS4A60H	HTS4A80H	
$V_{DRM}$	Repetitive Peak Off-State Voltage	Sine wave, 50/60Hz, Gate open	600	800	V
$V_{RRM}$	Repetitive Peak Reverse Voltage		600	800	V
$I_{T(AV)}$	Average On-State Current	Full sine wave, $T_C = 102^\circ\text{C}$	3.6		A
$I_{T(RMS)}$	R.M.S. On-State Current		4		A
$I_{TSM}$	Surge On-State Current	½ cycle, 50Hz/60Hz, Sine wave, Non repetitive	40/42		A
$I^2t$	Fusing Current	$t = 10\text{ms}$	8.8		A <sup>2</sup> S
$P_{GM}$	Forward Peak Gate Power Dissipation	$T_J = 125^\circ\text{C}$	5		W
$P_{G(AV)}$	Forward Average Gate Power Dissipation	$T_J = 125^\circ\text{C}$ , over any 20ms	0.5		W
$I_{FGM}$	Forward Peak Gate Current	$T_J = 125^\circ\text{C}$ , pulse width $\leq 20\mu\text{s}$	2		A
$V_{RGM}$	Reverse Peak Gate Voltage	$T_J = 125^\circ\text{C}$ , pulse width $\leq 20\mu\text{s}$	5		V
$T_J$	Operating Junction Temperature		-40~+150		$^\circ\text{C}$
$T_{STG}$	Storage Temperature		-40~+150		$^\circ\text{C}$

## Electrical Characteristics ( $T_J=25^\circ\text{C}$ unless otherwise specified )

Symbol	Parameter	Conditions	Min	Typ	Max	Unit	
$I_{\text{DRM}}$	Repetitive Peak Off-State Current	$V_D = V_{\text{DRM}}$	$T_J=25^\circ\text{C}$	-	-	50	$\mu\text{A}$
			$T_J=125^\circ\text{C}$	-	-	5	$\text{mA}$
$I_{\text{RRM}}$	Repetitive Peak Reverse Current	$V_D = V_{\text{DRM}}$	$T_J=25^\circ\text{C}$	-	-	50	$\mu\text{A}$
			$T_J=125^\circ\text{C}$	-	-	5	$\text{mA}$
$I_{\text{GT}}$	Gate Trigger Current	$V_D = 12\text{V}, R_L=330\Omega$	1+, 1-, 3-	-	-	25	$\text{mA}$
$V_{\text{GT}}$	Gate Trigger Voltage	$V_D = 12\text{V}, R_L=330\Omega$	1+, 1-, 3-	-	-	1.5	V
$V_{\text{GD}}$	Non-Trigger Gate Voltage <sup>1</sup>	$V_D = 12\text{V}, R_L=330\Omega, T_J=125^\circ\text{C}$		0.2	-	-	V
$V_{\text{TM}}$	Peak On-State Voltage	$I_T = 5.6\text{A}, I_G = 50\text{mA}$		-	1.4	1.7	V
dv/dt	Critical Rate of Rise of Off-State Voltage	$V_D = 2/3 V_{\text{DRM}}, T_J=125^\circ\text{C}$		200	-	-	V/us
$I_{\text{H}}$	Holding current	$I_T = 0.2\text{A}$		-	30	-	$\text{mA}$

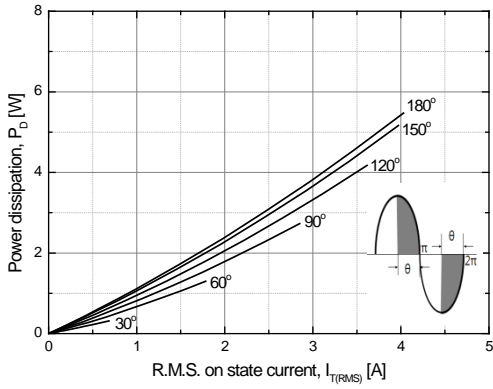
### Notes :

1. Pulse Width  $\leq 1.0\text{ms}$ , Duty Cycle  $\leq 1\%$

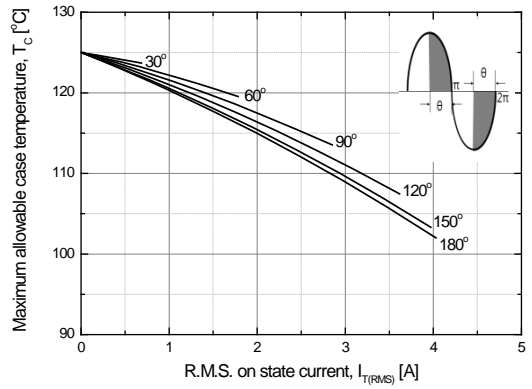
## Thermal Characteristics

Symbol	Parameter	Conditions	Min	Typ	Max	Unit
$R_{\theta\text{JC}}$	Thermal Resistance	Junction to Case			4.2	$^\circ\text{C/W}$
$R_{\theta\text{JA}}$	Thermal Resistance	Junction to Ambient			58	$^\circ\text{C/W}$

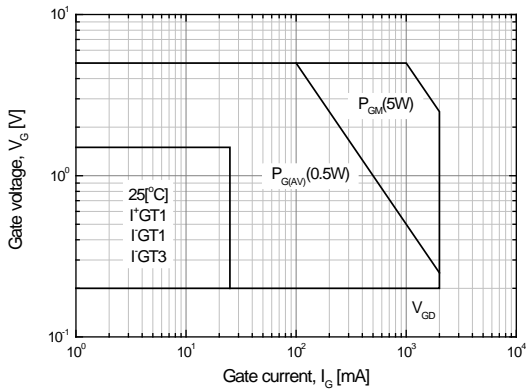
## Typical Characteristics



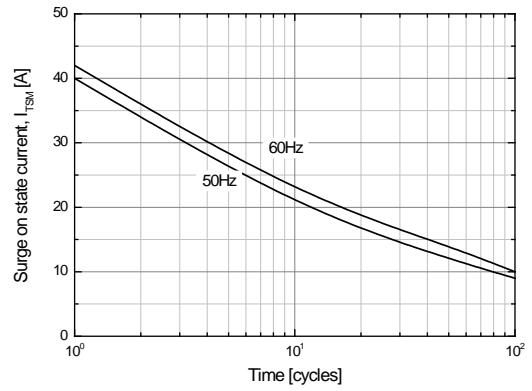
**Fig 1. R.M.S. current vs. Power dissipation**



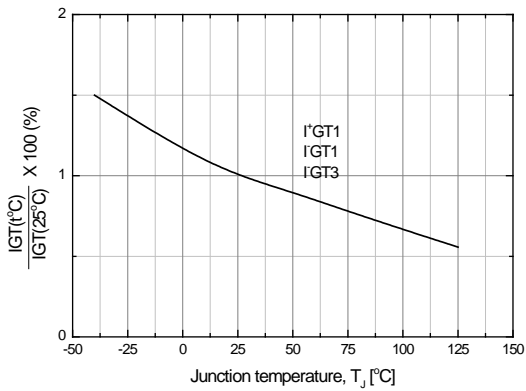
**Fig 2. R.M.S. current vs. Case temperature**



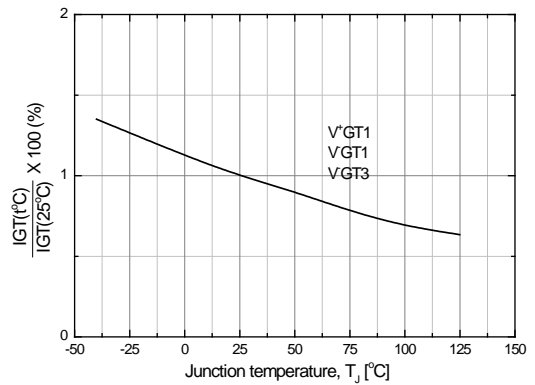
**Fig 3. Gate power characteristics**



**Fig 4. Surge on state current rating (Non-repetitive)**

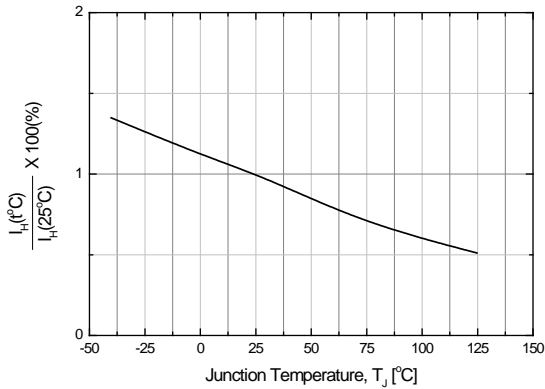


**Fig 5. Gate trigger current vs. junction temperature**

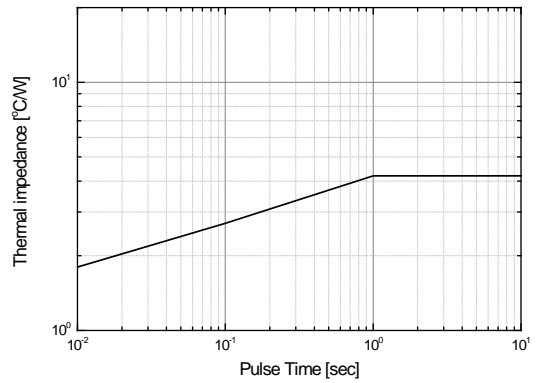


**Fig 6. Gate trigger voltage vs. junction temperature**

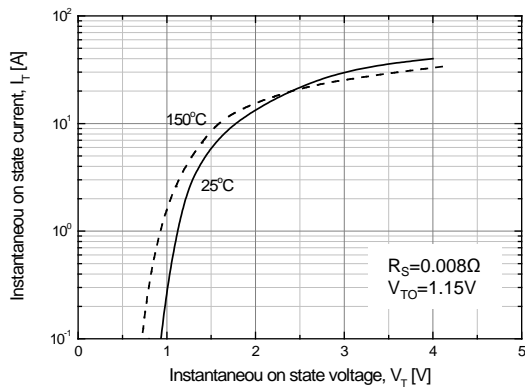
## Typical Characteristics



**Fig 7. Holding current vs. Junction temperature**

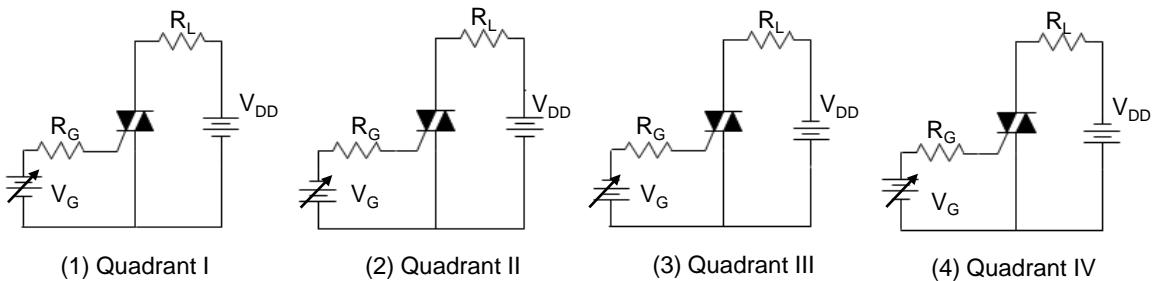


**Fig 8. Thermal Impedance vs. pulse time**



**Fig 9. Instantaneous on state current vs. Instantaneous on state voltage**

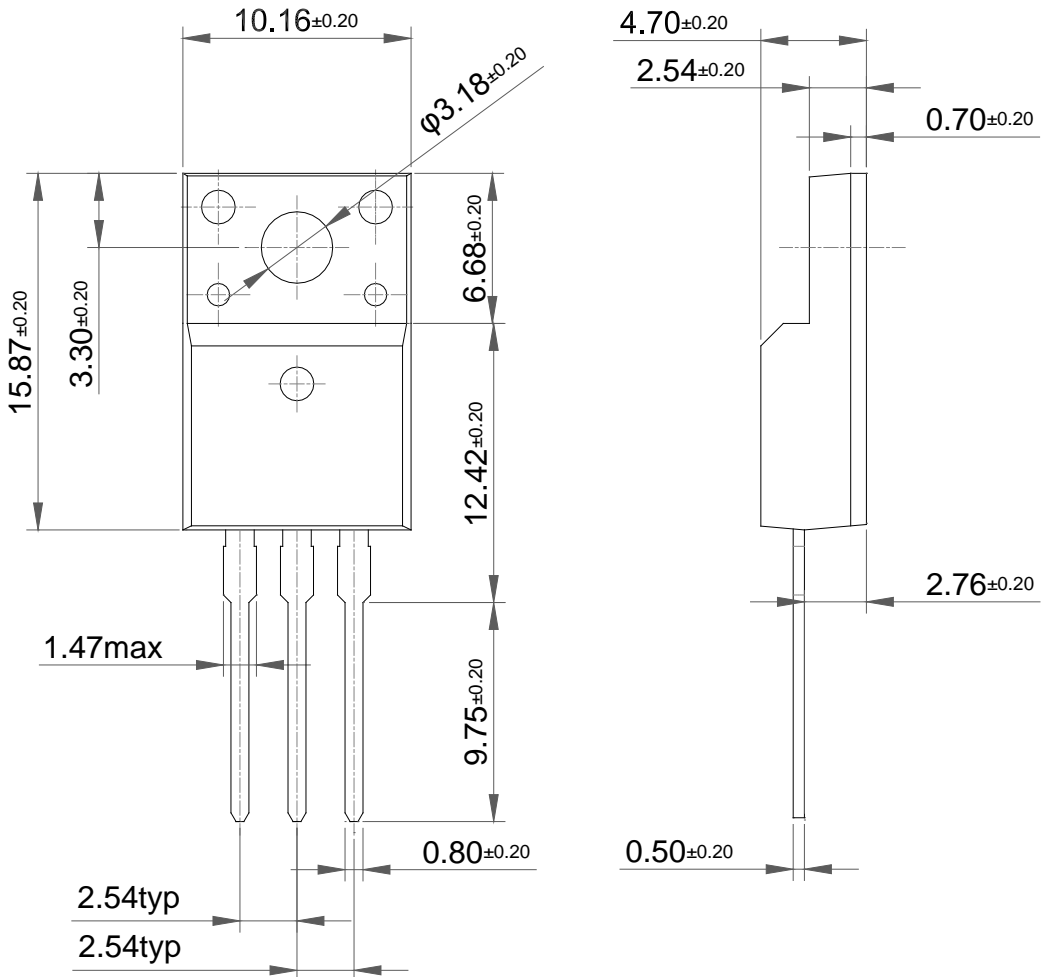
### Measurement of gate trigger current



Note. Whole parameter and test condition can not be over absolute maximum ratings in this datasheet.

Package Dimension

TO-220F



Package Dimension

TO-220F-Forming

