

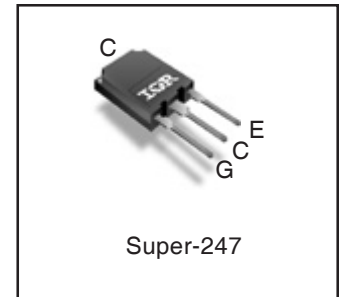
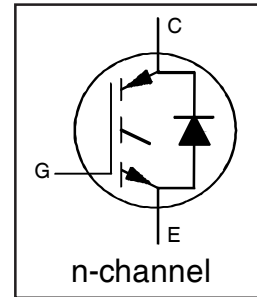
### INSULATED GATE BIPOLAR TRANSISTOR WITH ULTRAFAST SOFT RECOVERY DIODE

$$V_{CES} = 600V$$

$$I_C = 160A, T_C = 100^\circ C$$

$$t_{SC} \geq 5\mu s, T_{J(max)} = 175^\circ C$$

$$V_{CE(on)} \text{ typ.} = 1.70V @ I_C = 120A$$



<b>G</b>	<b>C</b>	<b>E</b>
Gate	Collector	Emitter

#### Applications

- Industrial Motor Drive
- Inverters
- UPS
- Welding

Features	Benefits
Low $V_{CE(ON)}$ and Switching Losses	High efficiency in a wide range of applications and switching frequencies
Square RBSOA and Maximum Junction Temperature 175°C	Improved reliability due to rugged hard switching performance and higher power capability
Positive $V_{CE(ON)}$ Temperature Coefficient	Excellent current sharing in parallel operation
5μs short circuit SOA	Enables short circuit protection scheme
Lead-Free, RoHS compliant	Environmentally friendly

Base part number	Package Type	Standard Pack		Orderable part number
		Form	Quantity	
IRGPS46160DPbF	Super-247	Tube	25	IRGPS46160DPbF

#### Absolute Maximum Ratings

Parameter	Max.	Units
$V_{CES}$ Collector-to-Emitter Voltage	600	V
$I_C @ T_C = 25^\circ C$ Continuous Collector Current	240 <sup>②</sup>	A
$I_C @ T_C = 100^\circ C$ Continuous Collector Current	160	
$I_{CM}$ Pulse Collector Current, $V_{GE} = 15V$	360	
$I_{LM}$ Clamped Inductive Load Current, $V_{GE} = 20V$ ①	480	
$I_F @ T_C = 25^\circ C$ Diode Continuous Forward Current	240 <sup>②</sup>	
$I_F @ T_C = 100^\circ C$ Diode Continuous Forward Current	160 <sup>②</sup>	V
$I_{FM}$ Diode Maximum Forward Current ④	480	
$V_{GE}$ Continuous Gate-to-Emitter Voltage	±20	V
$V_{GE}$ Transient Gate-to-Emitter Voltage	±30	
$P_D @ T_C = 25^\circ C$ Maximum Power Dissipation	750	W
$P_D @ T_C = 100^\circ C$ Maximum Power Dissipation	375	
$T_J$ Operating Junction and Storage Temperature Range	-55 to +175	°C
$T_{STG}$ Soldering Temperature, for 10 sec.	300 (0.063 in. (1.6mm) from case)	
$T_{STG}$ Mounting Torque, 6-32 or M3 Screw	10 lbf·in (1.1 N·m)	

#### Thermal Resistance

Parameter	Min.	Typ.	Max.	Units
$R_{\theta JC}$ (IGBT) Junction-to-Case (IGBT) ②	—	—	0.20	°C/W
$R_{\theta JC}$ (Diode) Junction-to-Case (Diode) ②	—	—	0.63	
$R_{\theta CS}$ Case-to-Sink (flat, greased surface)	—	0.24	—	
$R_{\theta JA}$ Junction-to-Ambient (typical socket mount)	—	—	40	

**Electrical Characteristics @ T<sub>J</sub> = 25°C (unless otherwise specified)**

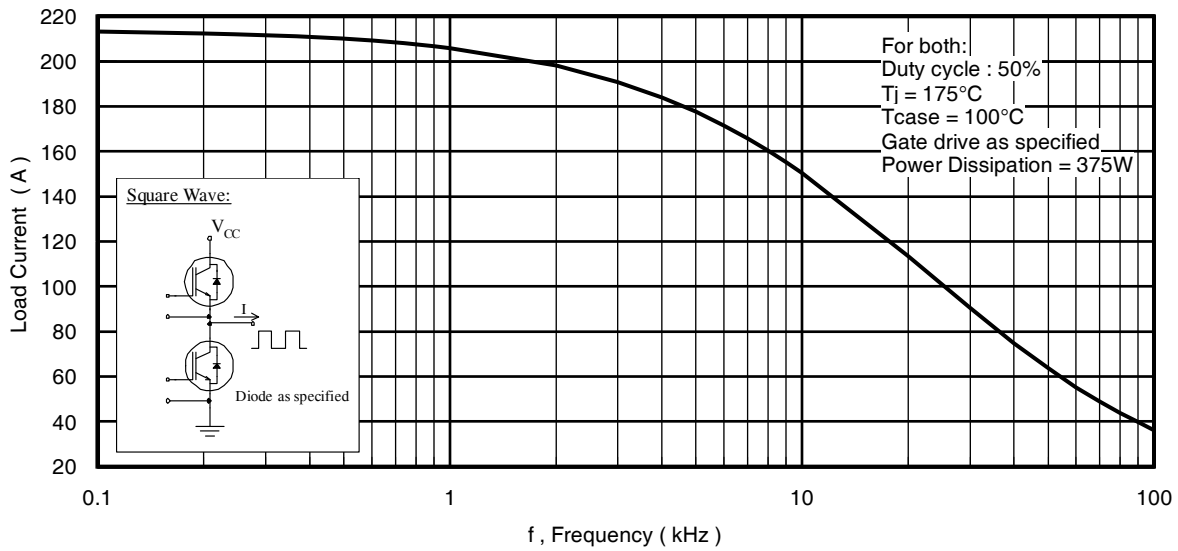
	Parameter	Min.	Typ.	Max.	Units	Conditions
V <sub>(BR)CES</sub>	Collector-to-Emitter Breakdown Voltage	600	—	—	V	V <sub>GE</sub> = 0V, I <sub>C</sub> = 100μA ③
ΔV <sub>(BR)CES</sub> /ΔT <sub>J</sub>	Temperature Coeff. of Breakdown Voltage	—	0.27	—	V/°C	V <sub>GE</sub> = 0V, I <sub>C</sub> = 4.0mA (25°C-175°C)
V <sub>CE(on)</sub>	Collector-to-Emitter Saturation Voltage	—	1.70	2.05	V	I <sub>C</sub> = 120A, V <sub>GE</sub> = 15V, T <sub>J</sub> = 25°C
		—	2.15	—		I <sub>C</sub> = 120A, V <sub>GE</sub> = 15V, T <sub>J</sub> = 150°C
		—	2.20	—		I <sub>C</sub> = 120A, V <sub>GE</sub> = 15V, T <sub>J</sub> = 175°C
V <sub>GE(th)</sub>	Gate Threshold Voltage	4.0	—	6.5	V	V <sub>CE</sub> = V <sub>GE</sub> , I <sub>C</sub> = 5.6mA
ΔV <sub>GE(th)</sub> /ΔT <sub>J</sub>	Threshold Voltage temp. coefficient	—	-17	—	mV/°C	V <sub>CE</sub> = V <sub>GE</sub> , I <sub>C</sub> = 5.6mA (25°C - 175°C)
g <sub>fe</sub>	Forward Transconductance	—	77	—	S	V <sub>CE</sub> = 50V, I <sub>C</sub> = 120A
I <sub>CES</sub>	Collector-to-Emitter Leakage Current	—	1.0	150	μA	V <sub>GE</sub> = 0V, V <sub>CE</sub> = 600V
		—	2.3	—	mA	V <sub>GE</sub> = 0V, V <sub>CE</sub> = 600V, T <sub>J</sub> = 175°C
V <sub>FM</sub>	Diode Forward Voltage Drop	—	2.4	3.0	V	I <sub>F</sub> = 120A
		—	1.9	—		I <sub>F</sub> = 120A, T <sub>J</sub> = 175°C
I <sub>GES</sub>	Gate-to-Emitter Leakage Current	—	—	±400	nA	V <sub>GE</sub> = ±20V

**Switching Characteristics @ T<sub>J</sub> = 25°C (unless otherwise specified)**

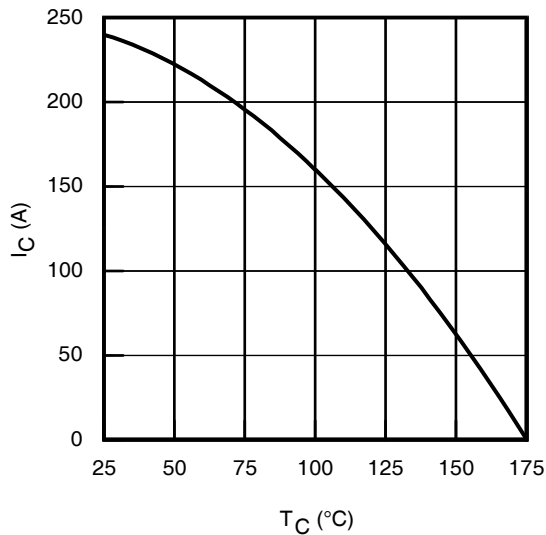
	Parameter	Min.	Typ.	Max.	Units	Conditions
Q <sub>g</sub>	Total Gate Charge	—	240	—	nC	I <sub>C</sub> = 120A V <sub>GE</sub> = 15V V <sub>CC</sub> = 400V
Q <sub>ge</sub>	Gate-to-Emitter Charge	—	70	—		
Q <sub>gc</sub>	Gate-to-Collector Charge	—	90	—		
E <sub>on</sub>	Turn-On Switching Loss	—	5750	—	μJ	I <sub>C</sub> = 120A, V <sub>CC</sub> = 400V, V <sub>GE</sub> = 15V R <sub>G</sub> = 4.7Ω, L = 66μH, T <sub>J</sub> = 25°C
E <sub>off</sub>	Turn-Off Switching Loss	—	3430	—		
E <sub>total</sub>	Total Switching Loss	—	9180	—		
t <sub>d(on)</sub>	Turn-On delay time	—	80	—	ns	Energy losses include tail & diode reverse recovery ⑥
t <sub>r</sub>	Rise time	—	70	—		
t <sub>d(off)</sub>	Turn-Off delay time	—	190	—		
t <sub>f</sub>	Fall time	—	40	—		
E <sub>on</sub>	Turn-On Switching Loss	—	7740	—	μJ	I <sub>C</sub> = 120A, V <sub>CC</sub> = 400V, V <sub>GE</sub> =15V R <sub>G</sub> = 4.7Ω, L = 66μH, T <sub>J</sub> = 175°C
E <sub>off</sub>	Turn-Off Switching Loss	—	4390	—		
E <sub>total</sub>	Total Switching Loss	—	12130	—		
t <sub>d(on)</sub>	Turn-On delay time	—	80	—	ns	Energy losses include tail & diode reverse recovery ⑥
t <sub>r</sub>	Rise time	—	75	—		
t <sub>d(off)</sub>	Turn-Off delay time	—	230	—		
t <sub>f</sub>	Fall time	—	55	—		
C <sub>ies</sub>	Input Capacitance	—	7750	—	pF	V <sub>GE</sub> = 0V V <sub>CC</sub> = 30V f = 1.0Mhz
C <sub>oes</sub>	Output Capacitance	—	550	—		
C <sub>res</sub>	Reverse Transfer Capacitance	—	225	—		
RBSOA	Reverse Bias Safe Operating Area	FULL SQUARE				T <sub>J</sub> = 175°C, I <sub>C</sub> = 480A V <sub>CC</sub> = 480V, V <sub>p</sub> ≤ 600V R <sub>G</sub> = 4.7 Ω, V <sub>GE</sub> = +20V to 0V
SCSOA	Short Circuit Safe Operating Area	5	—	—	μs	V <sub>CC</sub> = 400V, V <sub>p</sub> ≤ 600V R <sub>G</sub> = 4.7 Ω, V <sub>GE</sub> = +15V to 0V
E <sub>rec</sub>	Reverse Recovery Energy of the Diode	—	500	—	μJ	T <sub>J</sub> = 175°C
t <sub>rr</sub>	Diode Reverse Recovery Time	—	130	—	ns	V <sub>CC</sub> = 400V, I <sub>F</sub> = 120A
I <sub>rr</sub>	Peak Reverse Recovery Current	—	36	—	A	V <sub>GE</sub> = 15V, R <sub>G</sub> = 4.7 Ω, L = 100μH

**Notes:**

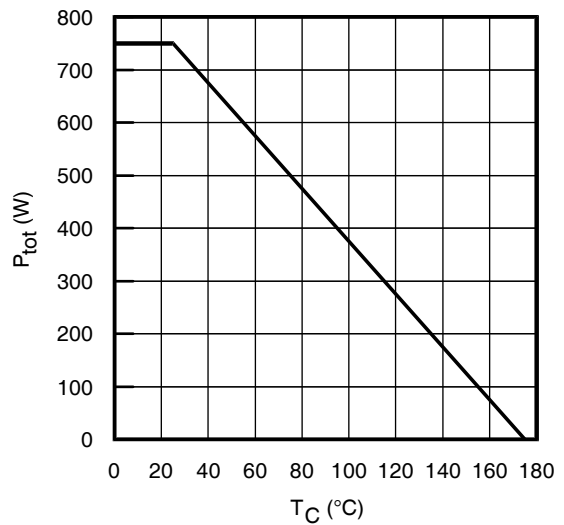
- ① V<sub>CC</sub> = 80% (V<sub>CES</sub>), V<sub>GE</sub> = 20V, L = 66μH, R<sub>G</sub> = 4.7Ω, tested in production I<sub>LM</sub> ≤ 400A.
- ② Pulse width limited by max. junction temperature.
- ③ Refer to AN-1086 for guidelines for measuring V<sub>(BR)CES</sub> safely.
- ④ R<sub>θ</sub> is measured at T<sub>J</sub> of approximately 90°C.
- ⑤ Values influenced by parasitic L and C in measurement.
- ⑥ Calculated continuous current based on maximum allowable junction temperature. Package IGBT current limit is 195A. Package diode current limit is 120A. Note that current limitations arising from heating of the device leads may occur.



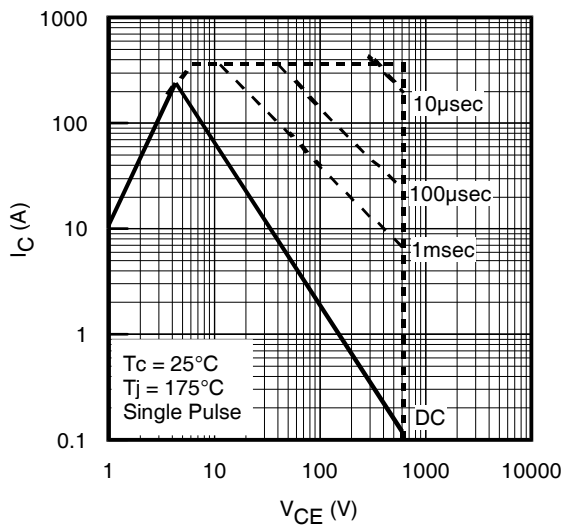
**Fig. 1 - Typical Load Current vs. Frequency**  
(Load Current =  $I_{RMS}$  of fundamental)



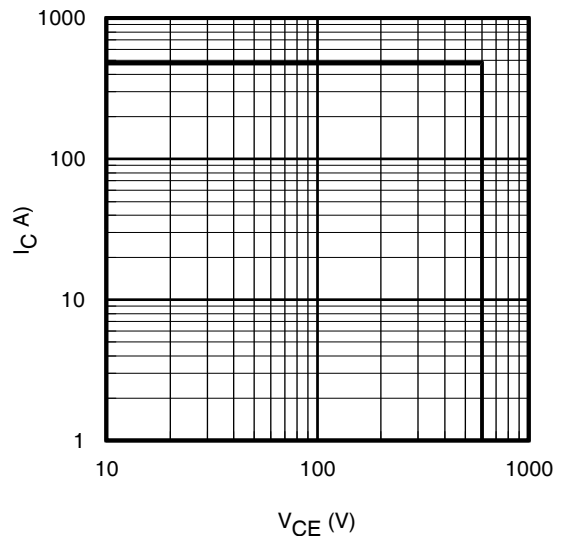
**Fig. 2 - Maximum DC Collector Current vs. Case Temperature**



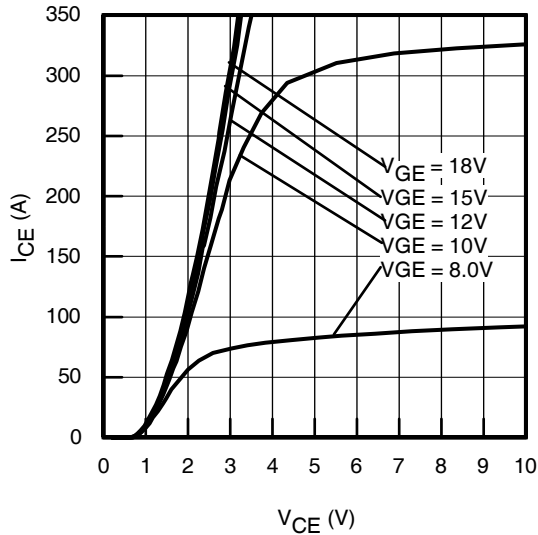
**Fig. 3 - Power Dissipation vs. Case Temperature**



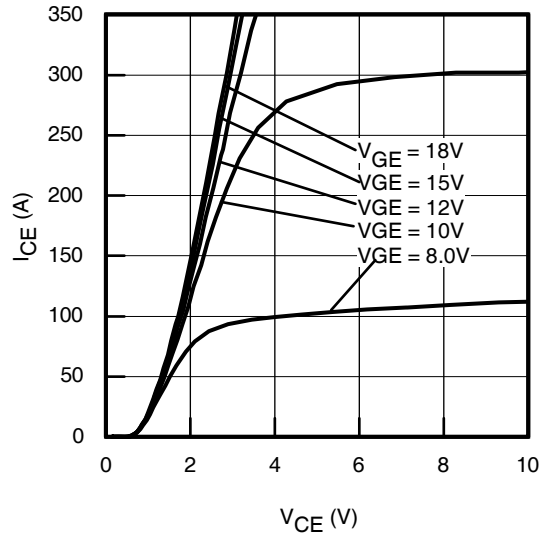
**Fig. 4 - Forward SOA**  
 $T_C = 25^\circ\text{C}$ ,  $T_J \leq 175^\circ\text{C}$ ;  $V_{GE} = 15\text{V}$



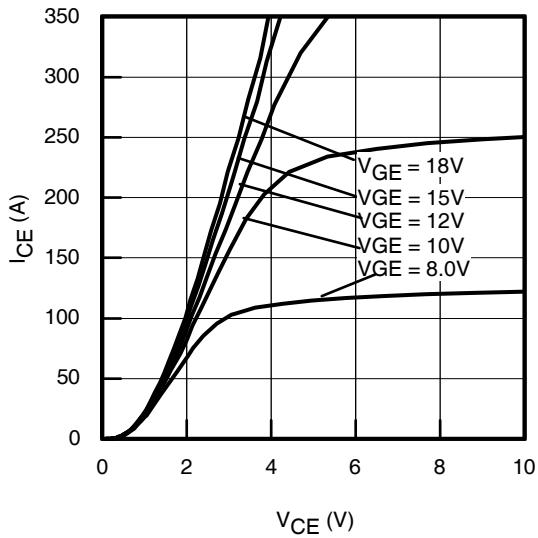
**Fig. 5 - Reverse Bias SOA**  
 $T_J = 175^\circ\text{C}$ ;  $V_{GE} = 20\text{V}$



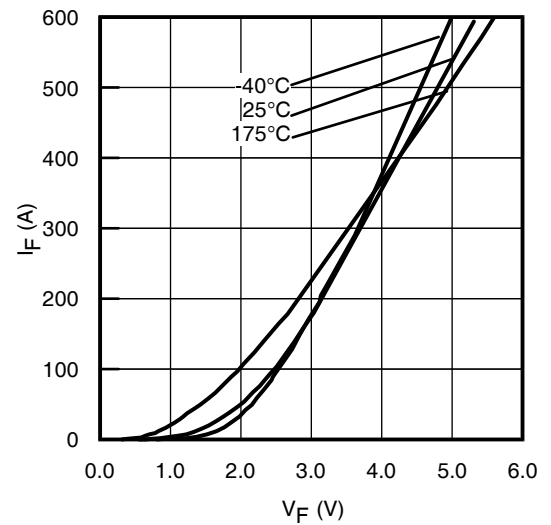
**Fig. 6** - Typ. IGBT Output Characteristics  
 $T_J = -40^\circ\text{C}$ ;  $t_p = 80\mu\text{s}$



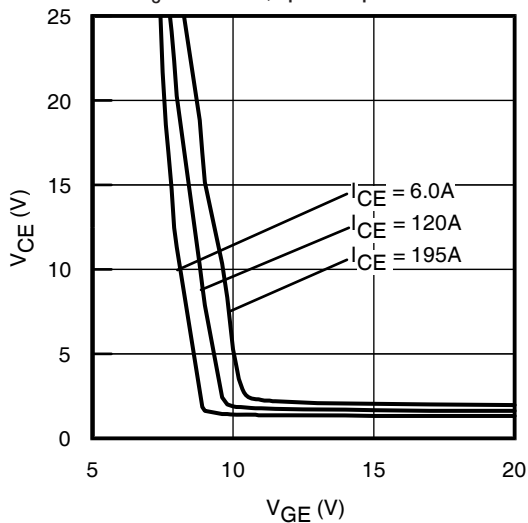
**Fig. 7** - Typ. IGBT Output Characteristics  
 $T_J = 25^\circ\text{C}$ ;  $t_p = 80\mu\text{s}$



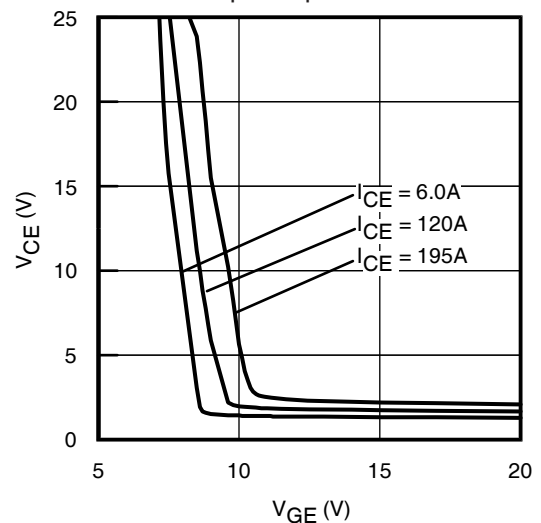
**Fig. 8** - Typ. IGBT Output Characteristics  
 $T_J = 175^\circ\text{C}$ ;  $t_p = 80\mu\text{s}$



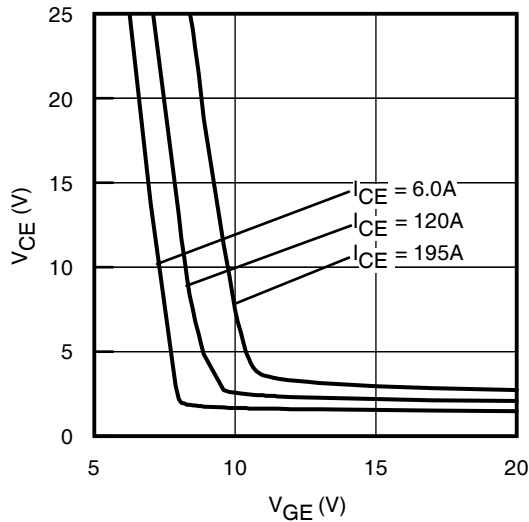
**Fig. 9** - Typ. Diode Forward Characteristics  
 $t_p = 80\mu\text{s}$



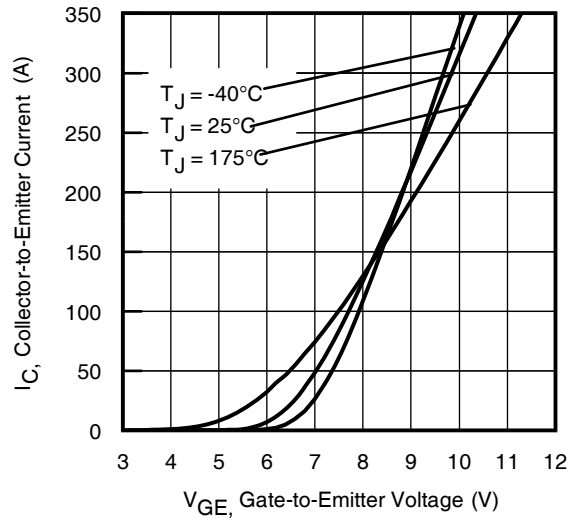
**Fig. 10** - Typical  $V_{CE}$  vs.  $V_{GE}$   
 $T_J = -40^\circ\text{C}$



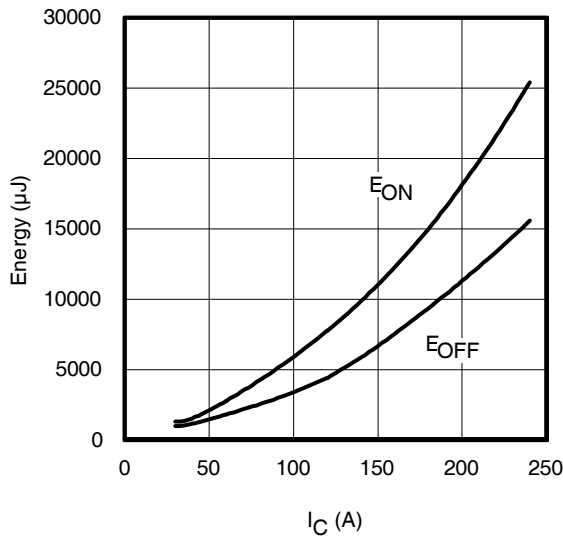
**Fig. 11** - Typical  $V_{CE}$  vs.  $V_{GE}$   
 $T_J = 25^\circ\text{C}$



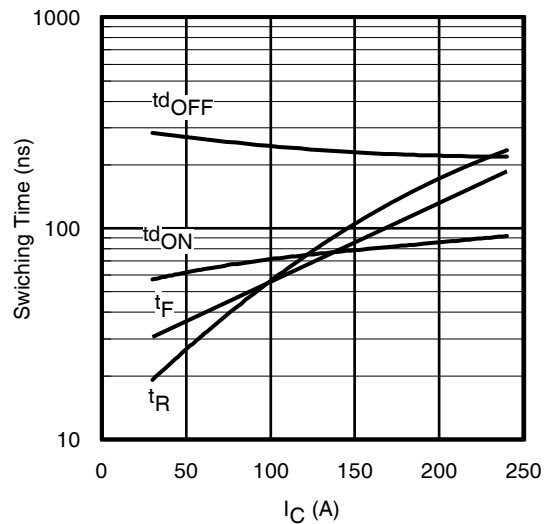
**Fig. 12** - Typical  $V_{CE}$  vs.  $V_{GE}$   
 $T_J = 175^\circ\text{C}$



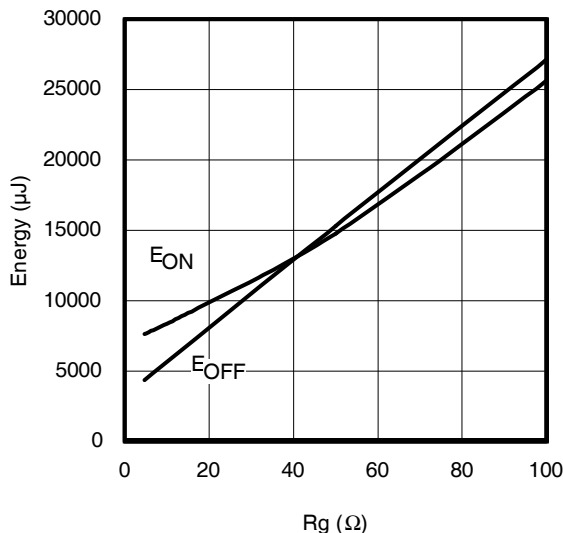
**Fig. 13** - Typ. Transfer Characteristics  
 $V_{CE} = 50\text{V}$ ;  $t_p = 10\mu\text{s}$



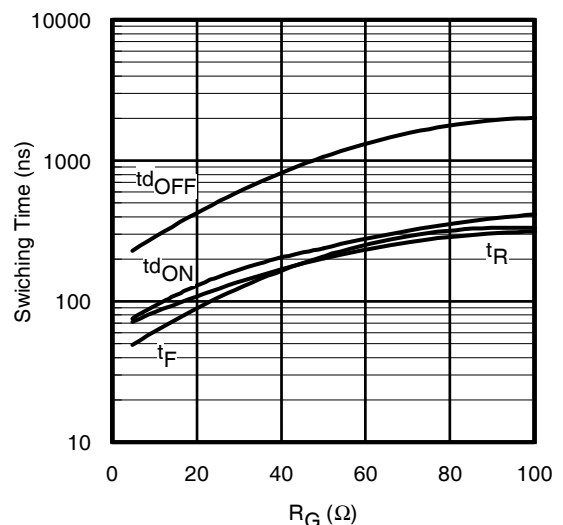
**Fig. 14** - Typ. Energy Loss vs.  $I_C$   
 $T_J = 175^\circ\text{C}$ ;  $L = 66\mu\text{H}$ ;  $V_{CE} = 400\text{V}$ ;  $R_G = 4.7\Omega$ ;  $V_{GE} = 15\text{V}$



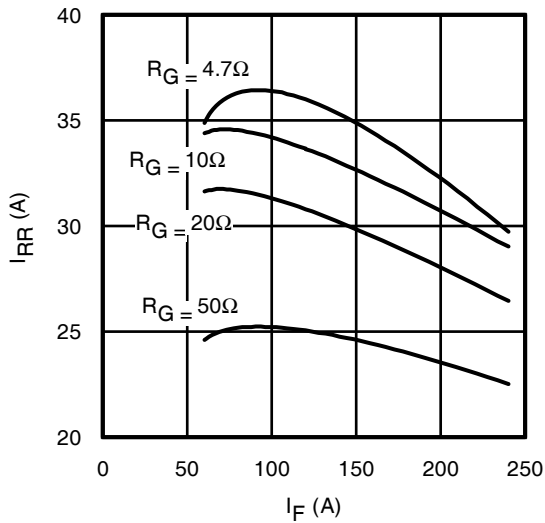
**Fig. 15** - Typ. Switching Time vs.  $I_C$   
 $T_J = 175^\circ\text{C}$ ;  $L = 66\mu\text{H}$ ;  $V_{CE} = 400\text{V}$ ;  $R_G = 4.7\Omega$ ;  $V_{GE} = 15\text{V}$



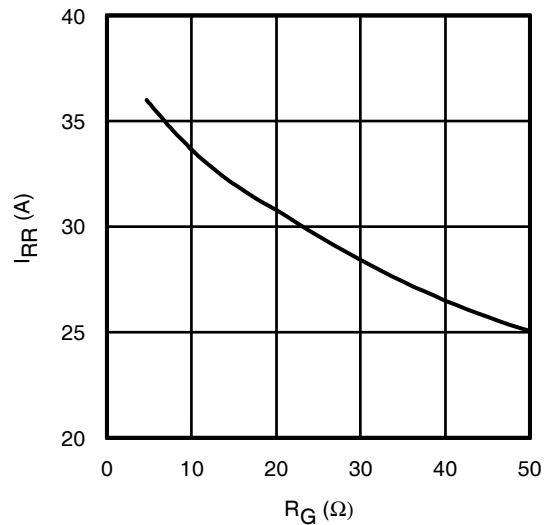
**Fig. 16** - Typ. Energy Loss vs.  $R_G$   
 $T_J = 175^\circ\text{C}$ ;  $L = 66\mu\text{H}$ ;  $V_{CE} = 400\text{V}$ ;  $I_{CE} = 120\text{A}$ ;  $V_{GE} = 15\text{V}$



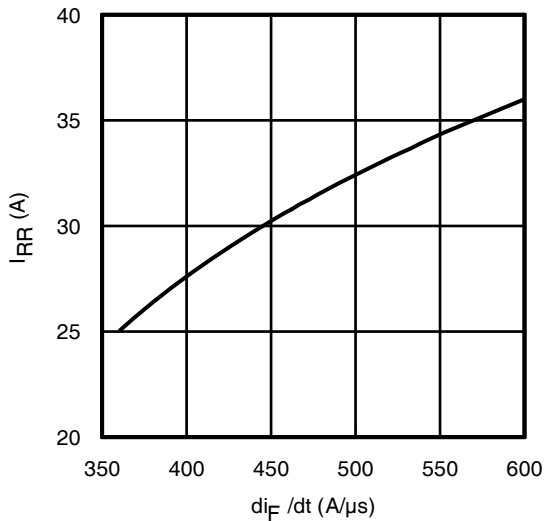
**Fig. 17** - Typ. Switching Time vs.  $R_G$   
 $T_J = 175^\circ\text{C}$ ;  $L = 66\mu\text{H}$ ;  $V_{CE} = 400\text{V}$ ;  $I_{CE} = 120\text{A}$ ;  $V_{GE} = 15\text{V}$



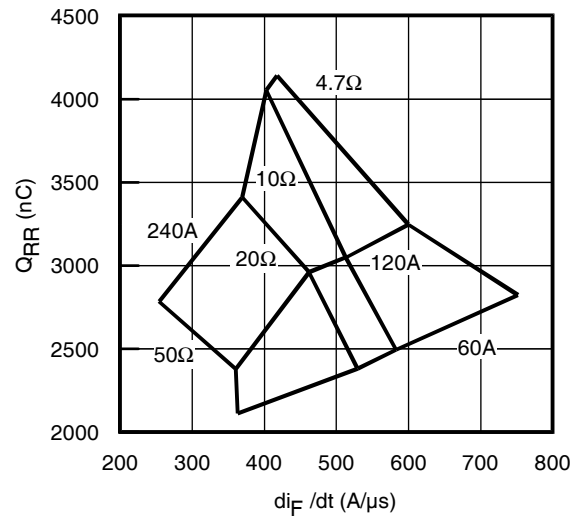
**Fig. 18** - Typ. Diode  $I_{RR}$  vs.  $I_F$   
 $T_J = 175^\circ\text{C}$



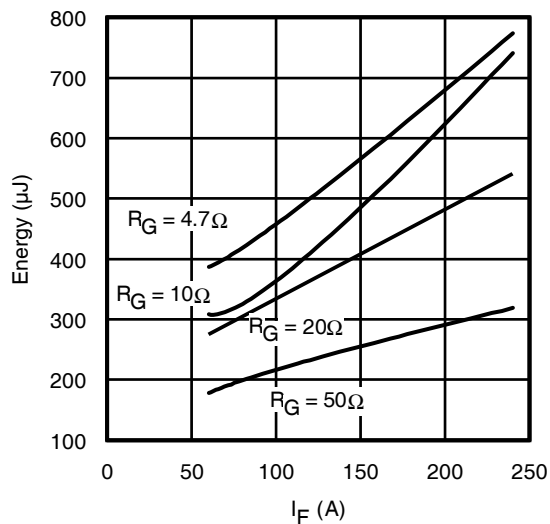
**Fig. 19** - Typ. Diode  $I_{RR}$  vs.  $R_G$   
 $T_J = 175^\circ\text{C}$



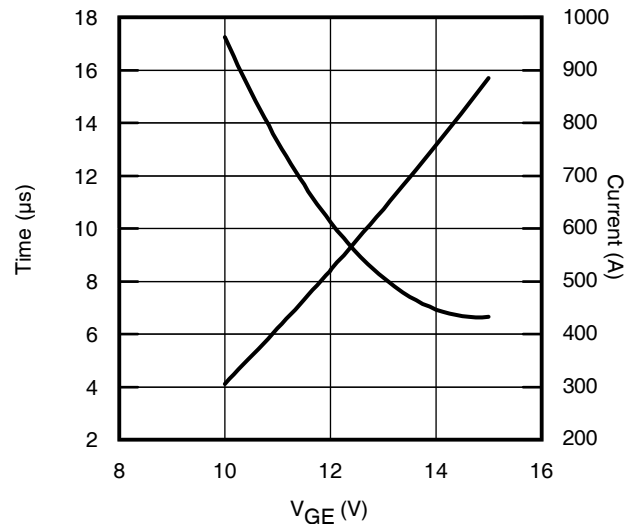
**Fig. 20** - Typ. Diode  $I_{RR}$  vs.  $di_F/dt$   
 $V_{CC} = 400\text{V}$ ;  $V_{GE} = 15\text{V}$ ;  $I_F = 120\text{A}$ ;  $T_J = 175^\circ\text{C}$



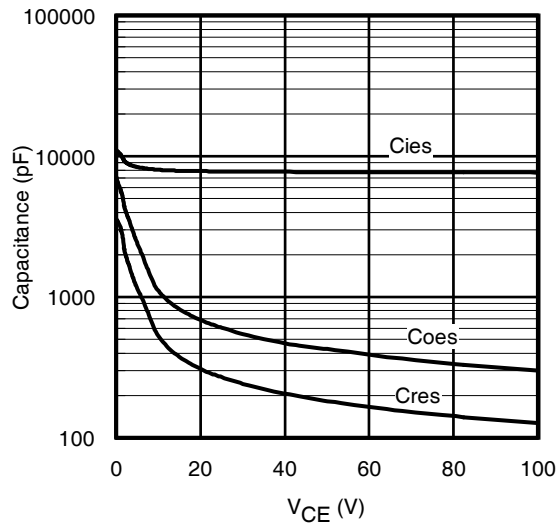
**Fig. 21** - Typ. Diode  $Q_{RR}$  vs.  $di_F/dt$   
 $V_{CC} = 400\text{V}$ ;  $V_{GE} = 15\text{V}$ ;  $T_J = 175^\circ\text{C}$



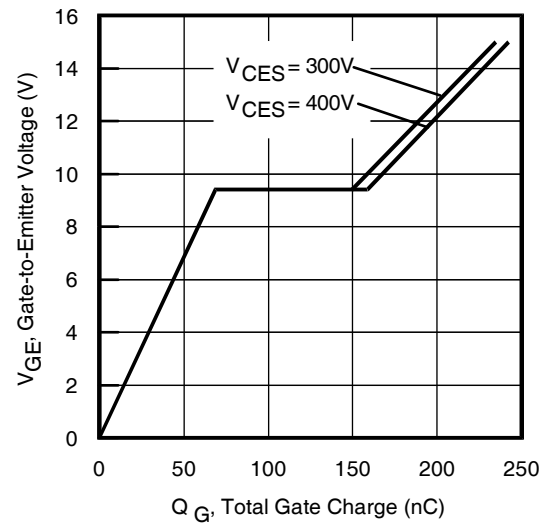
**Fig. 22** - Typ. Diode  $E_{RR}$  vs.  $I_F$   
 $T_J = 175^\circ\text{C}$



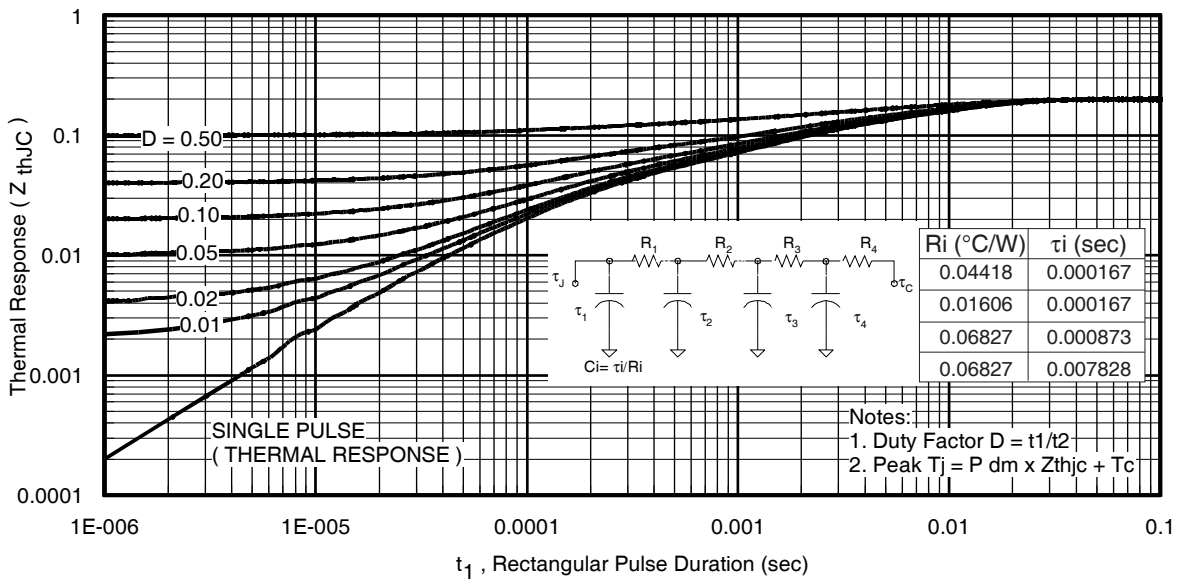
**Fig. 23** -  $V_{GE}$  vs. Short Circuit Time  
 $V_{CC} = 400\text{V}$ ;  $T_C = 25^\circ\text{C}$



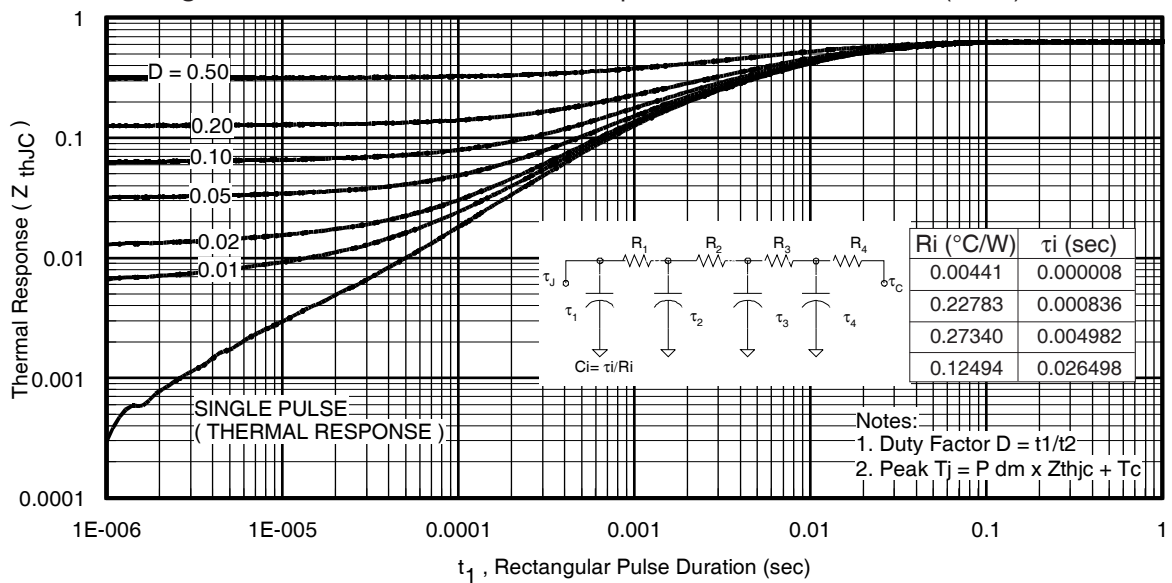
**Fig. 24 - Typ. Capacitance vs.  $V_{CE}$**   
 $V_{GE} = 0V$ ;  $f = 1MHz$



**Fig. 25 - Typical Gate Charge vs.  $V_{GE}$**   
 $I_{CE} = 120A$ ;  $L = 100\mu H$



**Fig. 26. Maximum Transient Thermal Impedance, Junction-to-Case (IGBT)**



**Fig. 27. Maximum Transient Thermal Impedance, Junction-to-Case (DIODE)**

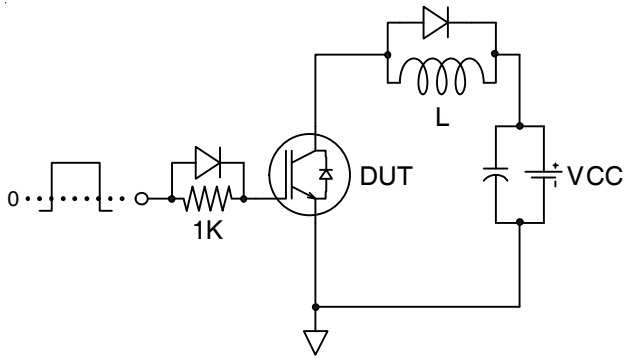


Fig.C.T.1 - Gate Charge Circuit (turn-off)

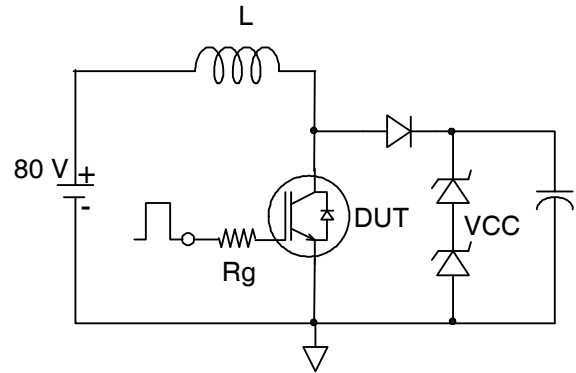


Fig.C.T.2 - RBSOA Circuit

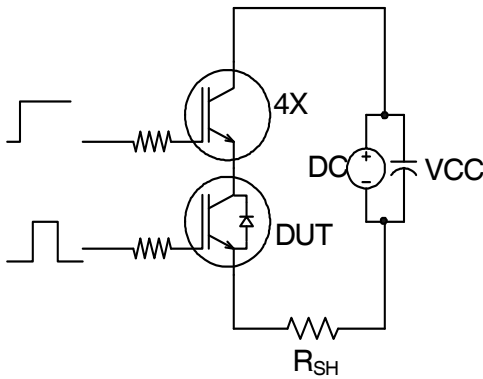


Fig.C.T.3 - S.C. SOA Circuit

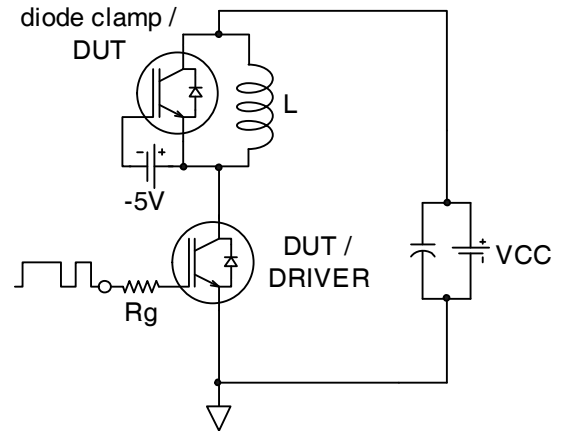


Fig.C.T.4 - Switching Loss Circuit

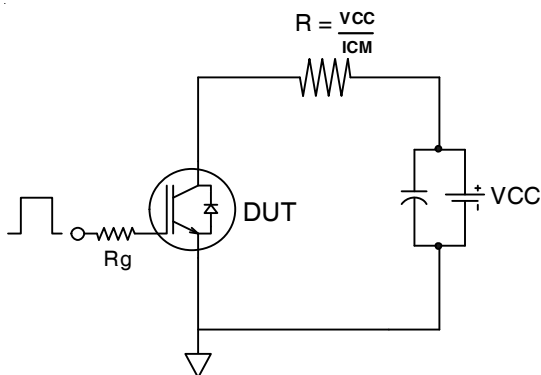


Fig.C.T.5 - Resistive Load Circuit

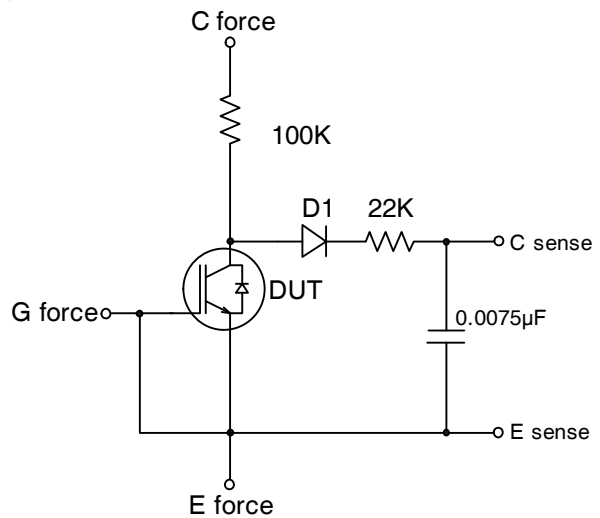
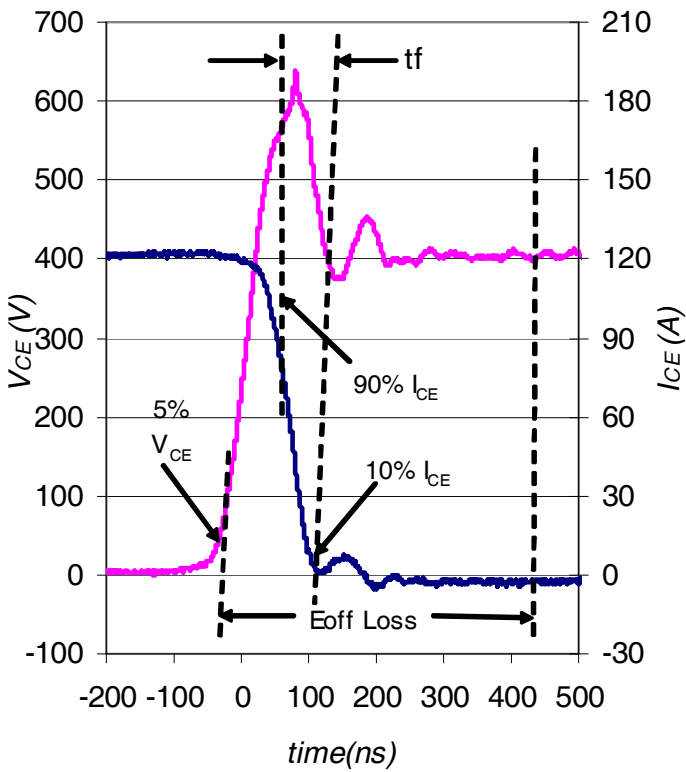
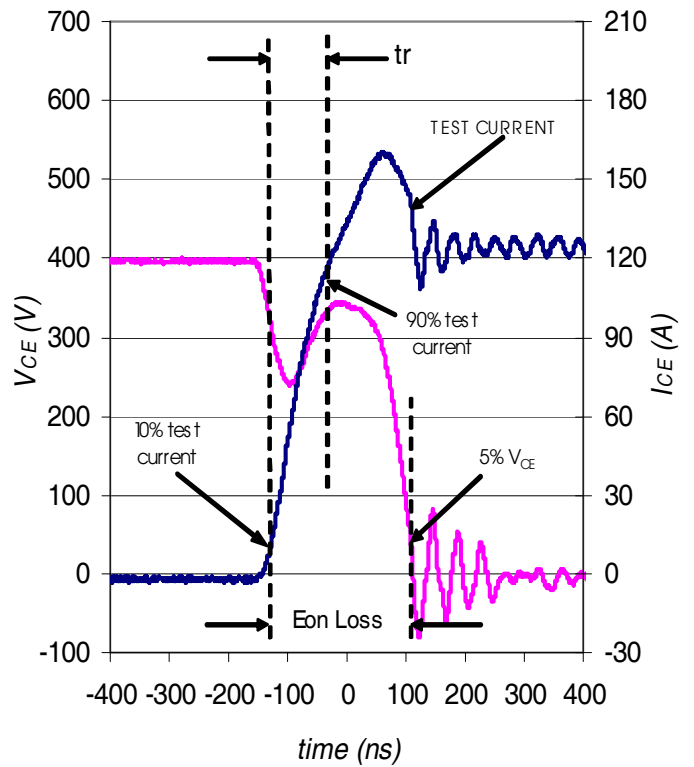


Fig.C.T.6 - BVCES Filter Circuit

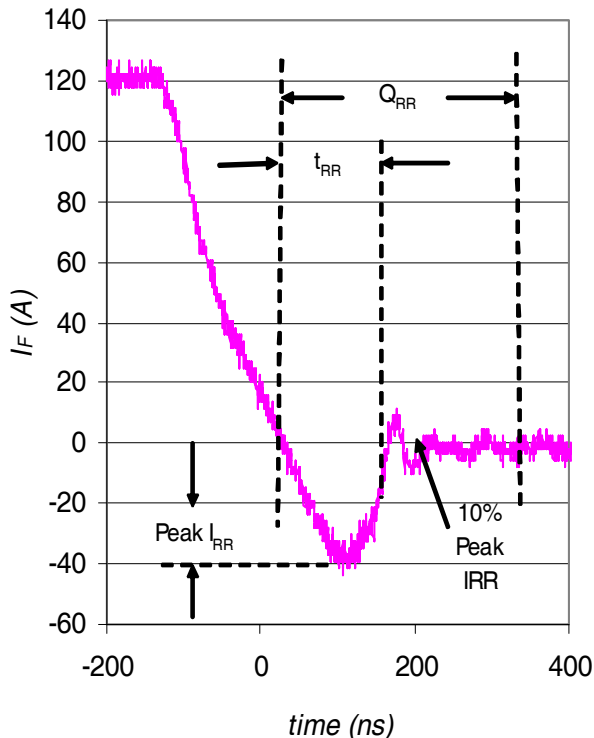




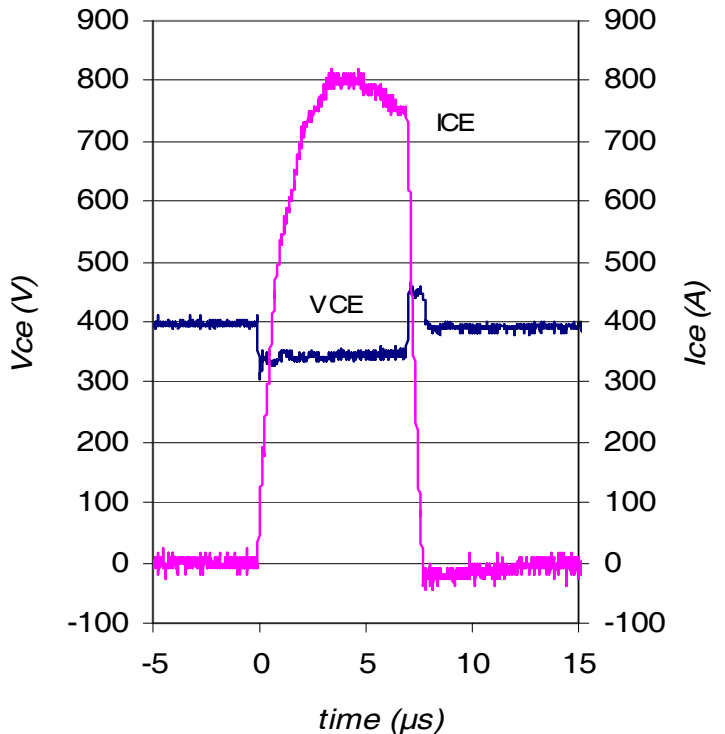
**Fig. WF1** - Typ. Turn-off Loss Waveform  
@  $T_J = 175^\circ\text{C}$  using Fig. CT.4



**Fig. WF2** - Typ. Turn-on Loss Waveform  
@  $T_J = 175^\circ\text{C}$  using Fig. CT.4

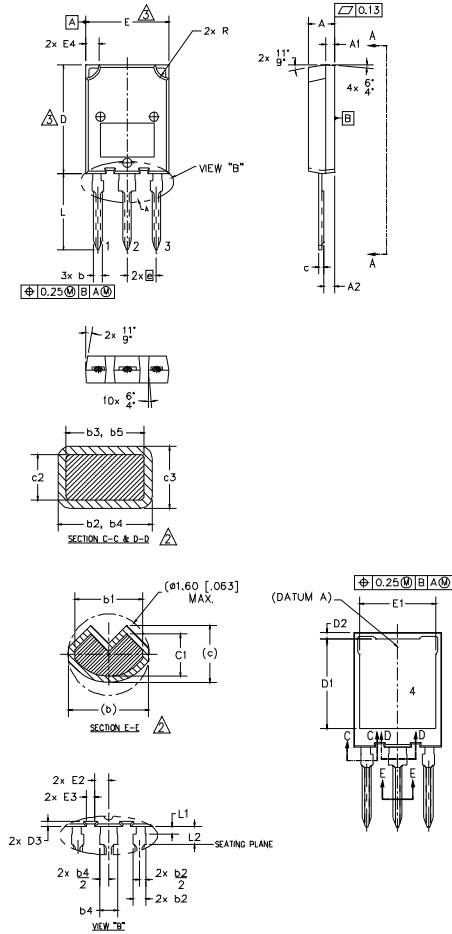


**Fig. WF3** - Typ. Diode Recovery Waveform  
@  $T_J = 175^\circ\text{C}$  using Fig. CT.4



**Fig. WF4** - Typ. S.C. Waveform  
@  $T_J = 25^\circ\text{C}$  using Fig. CT.3

# Case Outline and Dimensions — Super-247



- NOTES:
1. DIMENSIONING AND TOLERANCING AS PER ASME Y14.5M-1994
  2. DIMENSIONS b1, b3, b5, c1 & c3 APPLY TO BASE METAL ONLY.
  3. DIMENSION D & E DO NOT INCLUDE MOLD FLASH. MOLD FLASH SHALL NOT EXCEED 0.127 [.005"] PER SIDE. THESE DIMENSIONS ARE MEASURED AT THE OUTER EXTREMES OF THE PLASTIC BODY.
  4. ALL DIMENSIONS SHOWN IN MILLIMETERS.
  5. CONTROLLING DIMENSION: MILLIMETER.
  6. OUTLINE CONFORMS TO JEDEC OUTLINE TO-274AA

SYMBOL	DIMENSIONS				NOTES
	MILLIMETERS		INCHES		
	MIN.	MAX.	MIN.	MAX.	
A	4.50	5.50	.177	.217	
A1	1.45	2.15	.057	.085	
A2	1.65	2.35	.065	.093	
b	1.45	1.60	.054	.063	
b1	1.40	1.50	.055	.059	2
b2	2.00	2.40	.079	.094	
b3	1.95	2.35	.077	.093	2
b4	3.00	3.15	.118	.124	
b5	2.95	3.35	.116	.132	2
c	1.10	1.30	.043	.051	
c1	0.90	1.10	.035	.043	2
c2	0.65	0.85	.026	.033	
c3	0.50	0.70	.020	.028	2
D	19.80	20.80	.780	.819	3
D1	15.50	16.10	.610	.634	
D2	0.70	1.30	.028	.051	
D3	0.75	1.25	.030	.049	
E	15.10	16.10	.594	.634	3
E1	13.30	13.90	.524	.547	
E2	2.25	2.70	.089	.109	
E3	1.20	1.70	.047	.067	
E4	2.00	3.00	.079	.118	
e	5.45 BSC		.215 BSC		
L	13.80	14.80	.535	.583	
L1	1.00	1.60	.039	.063	
L2	3.85	4.25	.152	.167	
R	2.00	3.00	.079	.118	

**LEAD ASSIGNMENTS**

**MOSEFT**

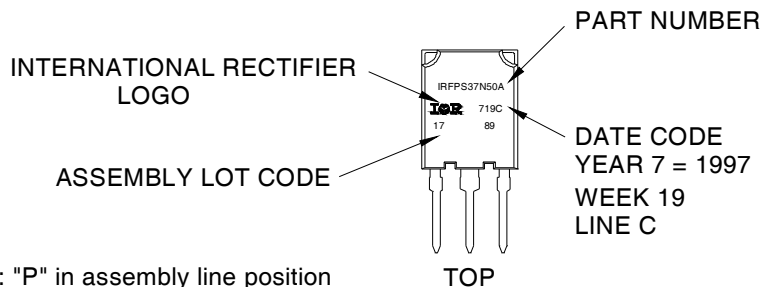
1. - GATE
2. - DRAIN
3. - SOURCE
4. - DRAIN

**IGBT**

1. - GATE
2. - COLLECTOR
3. - EMITTER
4. - COLLECTOR

## Super-247 (TO-274AA) Part Marking Information

EXAMPLE: THIS IS AN IRFPS37N50A WITH  
ASSEMBLY LOT CODE 1789  
ASSEMBLED ON WW 19, 1997  
IN THE ASSEMBLY LINE "C"



Note: "P" in assembly line position indicates "Lead-Free"

Note: For the most current drawing please refer to IR website at <http://www.irf.com/package/>

**Qualification Information<sup>†</sup>**

<b>Qualification Level</b>		Industrial (per International Rectifier's internal guidelines)	
<b>Moisture Sensitivity Level</b>		Super-247	N/A
<b>ESD</b>	Human Body Model	Class H3B ( 8000V ) <sup>††</sup> AEC-Q101-001	
	Charged Device Model	Class C5 (1125V ) <sup>††</sup> AEC-Q101-005	
<b>RoHS Compliant</b>		Yes	

† Qualification standards can be found at International Rectifier's web site: <http://www.irf.com/product-info/reliability>

†† Highest passing voltage.

**Revision History**

<b>Date</b>	<b>Comments</b>
11/14/2014	<ul style="list-style-type: none"> <li>• Added note ④ to I<sub>FM</sub> Diode Maximum Forward Current on page 1.</li> <li>• Added note ⑤ to switching losses test condition on page 2.</li> </ul>