

## FEATURES

- Ultra Low Loss
- High Ruggedness
- High Short Circuit Capability
- Positive Temperature Coefficient
- With Fast Free-Wheeling Diodes

## APPLICATIONS

- Invector
- Converter
- Welder
- SMPS and UPS
- Induction Heating



## ABSOLUTE MAXIMUM RATINGS

$T_C=25^{\circ}\text{C}$  unless otherwise specified

Symbol	Parameter	Test Conditions	Values	Unit
<b>IGBT</b>				
$V_{CES}$	Collector - Emitter Voltage		1200	V
$V_{GES}$	Gate - Emitter Voltage		$\pm 20$	V
$I_C$	DC Collector Current	$T_C=25^{\circ}\text{C}$	300	A
		$T_C=80^{\circ}\text{C}$	210	A
$I_{Cpuls}$	Pulsed Collector Current	$T_C=25^{\circ}\text{C}, t_p=1\text{ms}$	600	A
		$T_C=80^{\circ}\text{C}, t_p=1\text{ms}$	420	A
$P_{tot}$	Power Dissipation Per IGBT		1400	W
$T_J$	Junction Temperature Range		-40 to +150	$^{\circ}\text{C}$
$T_{STG}$	Storage Temperature Range		-40 to +125	$^{\circ}\text{C}$
$V_{isol}$	Insulation Test Voltage	AC, $t=1\text{min}$	3000	V
<b>Free-Wheeling Diode</b>				
$V_{RRM}$	Repetitive Reverse Voltage		1200	V
$I_{F(AV)}$	Average Forward Current	$T_C=25^{\circ}\text{C}$	250	A
		$T_C=80^{\circ}\text{C}$	170	A
$I_{F(RMS)}$	RMS Forward Current		250	A
$I_{FSM}$	Non-Repetitive Surge	$T_J=45^{\circ}\text{C}, t=10\text{ms}, \text{Sine}$	1860	A
	Forward Current	$T_J=45^{\circ}\text{C}, t=8.3\text{ms}, \text{Sine}$	1920	A

# MIMMG200DR120UA

## ELECTRICAL CHARACTERISTICS

T<sub>C</sub>=25°C unless otherwise specified

Symbol	Parameter	Test Conditions	Min.	Typ.	Max.	Unit
<b>IGBT</b>						
V <sub>GE(th)</sub>	Gate - Emitter Threshold Voltage	V <sub>CE</sub> =V <sub>GE</sub> , I <sub>C</sub> =8mA	5	6.2	7	V
V <sub>CE(sat)</sub>	Collector - Emitter Saturation Voltage	I <sub>C</sub> =200A, V <sub>GE</sub> =15V, T <sub>J</sub> =25°C		1.8		V
		I <sub>C</sub> =200A, V <sub>GE</sub> =15V, T <sub>J</sub> =125°C		2.0		V
I <sub>CES</sub>	Collector Leakage Current	V <sub>CE</sub> =1200V, V <sub>GE</sub> =0V, T <sub>J</sub> =25°C		0.4	1	mA
		V <sub>CE</sub> =1200V, V <sub>GE</sub> =0V, T <sub>J</sub> =125°C		6		mA
I <sub>GES</sub>	Gate Leakage Current	V <sub>CE</sub> =0V, V <sub>GE</sub> =±20V	-400		400	nA
Q <sub>ge</sub>	Gate Charge	V <sub>CC</sub> =600V, I <sub>C</sub> =200A, V <sub>GE</sub> =±15V		2100		nC
C <sub>ies</sub>	Input Capacitance	V <sub>CE</sub> =25V, V <sub>GE</sub> =0V, f=1MHz		14.9		nF
C <sub>oes</sub>	Output Capacitance			1.04		nF
C <sub>res</sub>	Reverse Transfer Capacitance			0.7		nF
t <sub>d(on)</sub>	Turn - on Delay Time	V <sub>CC</sub> =600V, I <sub>C</sub> =200A		125		ns
t <sub>r</sub>	Rise Time	R <sub>G</sub> =5 Ω, V <sub>GE</sub> =±15V		60		ns
t <sub>d(off)</sub>	Turn - off Delay Time	T <sub>J</sub> =25°C		420		ns
t <sub>f</sub>	Fall Time	Inductive Load		60		ns
t <sub>d(on)</sub>	Turn - on Delay Time	V <sub>CC</sub> =600V, I <sub>C</sub> =200A		135		ns
t <sub>r</sub>	Rise Time	R <sub>G</sub> =5 Ω, V <sub>GE</sub> =±15V		60		ns
t <sub>d(off)</sub>	Turn - off Delay Time	T <sub>J</sub> =125°C		490		ns
t <sub>f</sub>	Fall Time	Inductive Load		75		ns
E <sub>on</sub>	Turn - on Switching Energy	V <sub>CC</sub> =600V, I <sub>C</sub> =200A, T <sub>J</sub> =25°C		17		mJ
		R <sub>G</sub> =5 Ω, T <sub>J</sub> =125°C		24.8		mJ
E <sub>off</sub>	Turn - off Switching Energy	V <sub>GE</sub> =±15V, T <sub>J</sub> =25°C		13.6		mJ
		Inductive Load, T <sub>J</sub> =125°C		21.6		mJ
<b>Free-Wheeling Diode</b>						
V <sub>F</sub>	Forward Voltage	I <sub>F</sub> =200A, V <sub>GE</sub> =0V, T <sub>J</sub> =25°C		2.0	2.44	V
		I <sub>F</sub> =200A, V <sub>GE</sub> =0V, T <sub>J</sub> =125°C		1.7	2.20	V
t <sub>rr</sub>	Reverse Recovery Time	I <sub>F</sub> =200A, V <sub>R</sub> =800V		260		ns
I <sub>RRM</sub>	Max. Reverse Recovery Current	di <sub>F</sub> /dt=-1000A/μs		110		A
Q <sub>rr</sub>	Reverse Recovery Charge	T <sub>J</sub> =125°C		13.5		μC

## THERMAL AND MECHANICAL CHARACTERISTICS

Symbol	Parameter	Test Conditions	Min.	Typ.	Max.	Unit
R <sub>thJC</sub>	Junction-to-Case Thermal Resistance	Per IGBT			0.09	K /W
R <sub>thJCD</sub>	Junction-to-Case Thermal Resistance	Per Inverse Diode			0.22	K /W
Torque	Module-to-Sink	Recommended (M6)	3		5	N· m
Torque	Module Electrodes	Recommended (M6)	2.5		5	N· m
Weight				285		g

# MIMMG200DR120UA

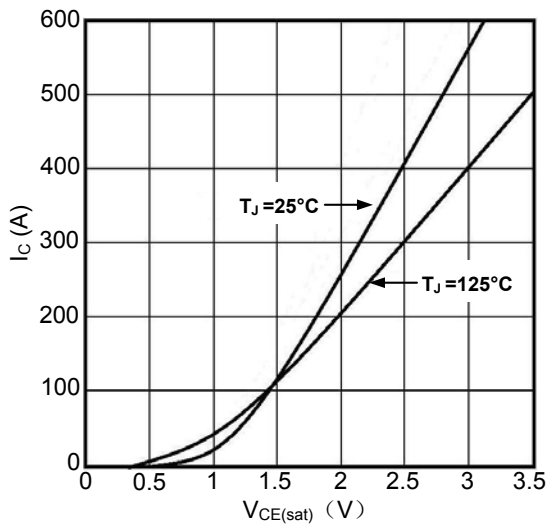

Figure 1. Typical Output characteristics

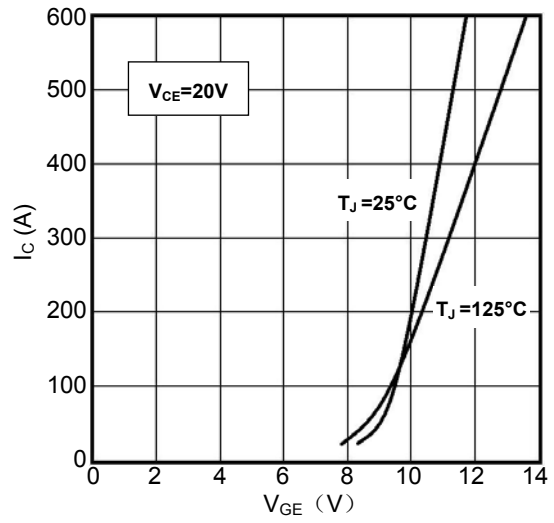

Figure 2. Typical Transfer characteristics

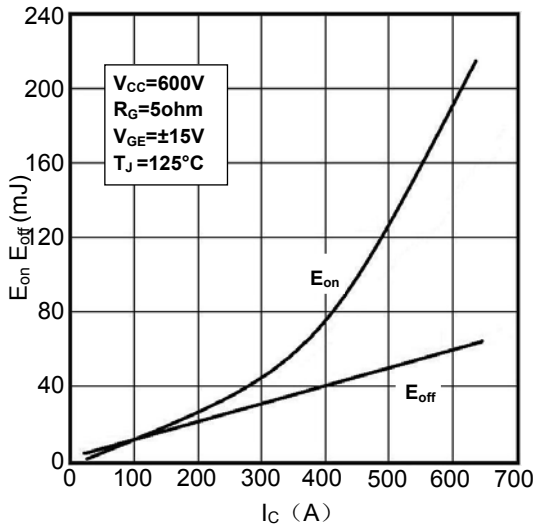

Figure 3. Switching Energy vs. Collector Current

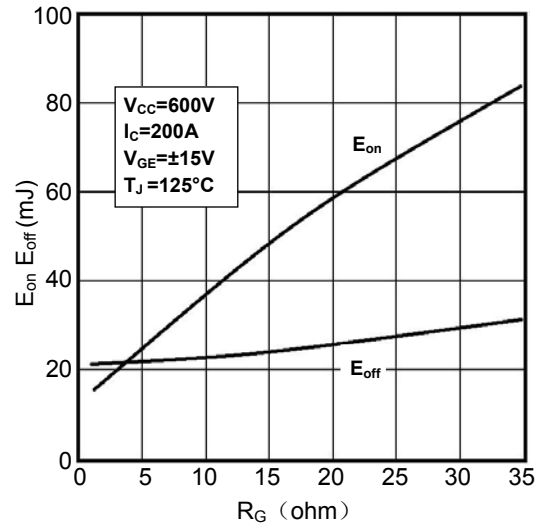

Figure 4. Switching Energy vs. Gate Resistor

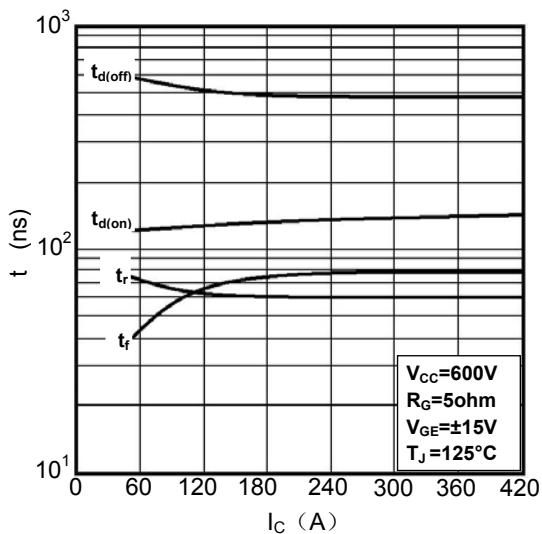

Figure 5. Switching Times vs. Collector Current

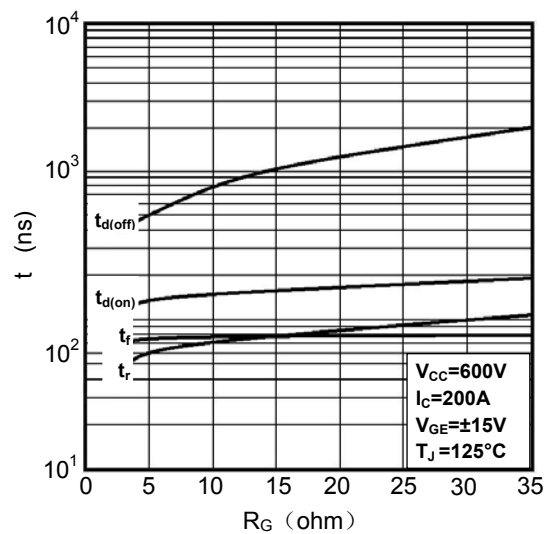

Figure 6. Switching Times vs. Gate Resistor

# MIMMG200DR120UA

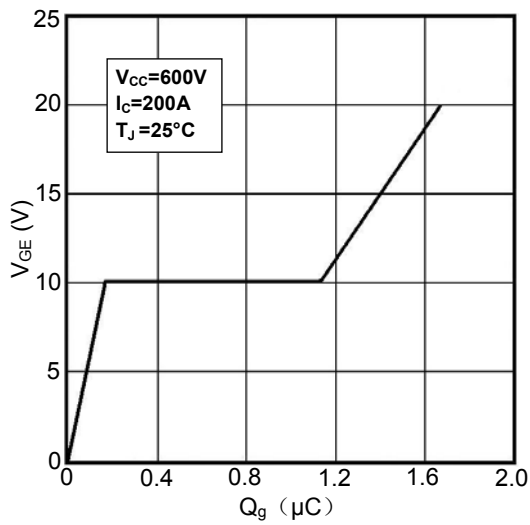

Figure7. Gate Charge characteristics

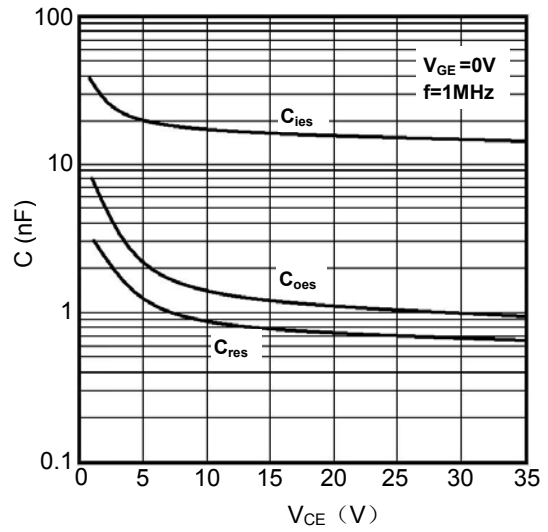

Figure8. Typical Capacitances vs.  $V_{CE}$

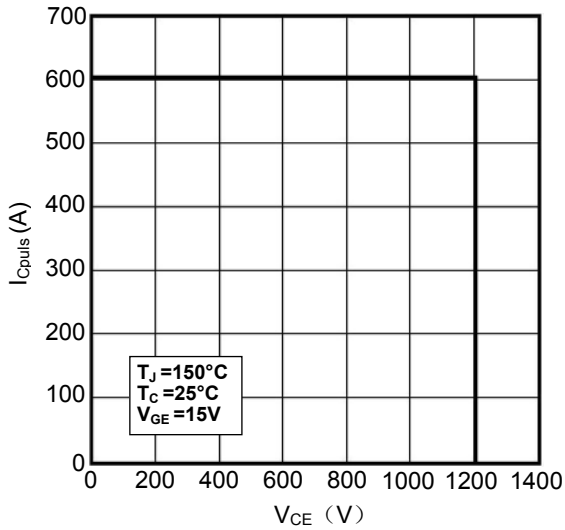

Figure9. Reverse Biased Safe Operating Area

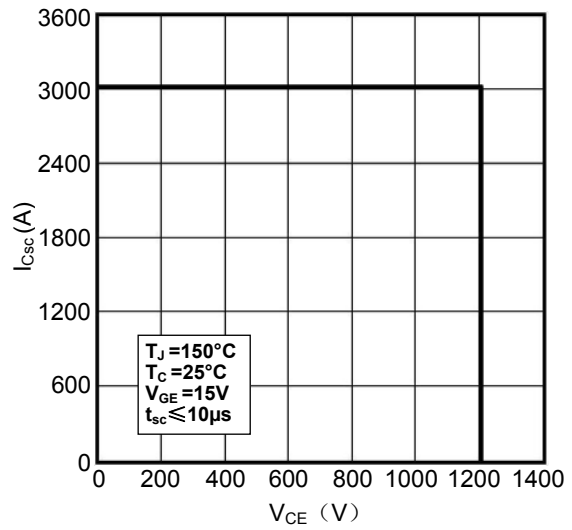

Figure10. Short Circuit Safe Operating Area

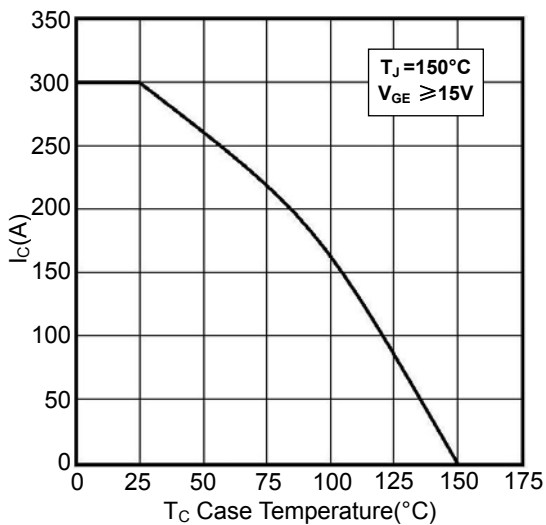

Figure11. Rated Current vs.  $T_C$

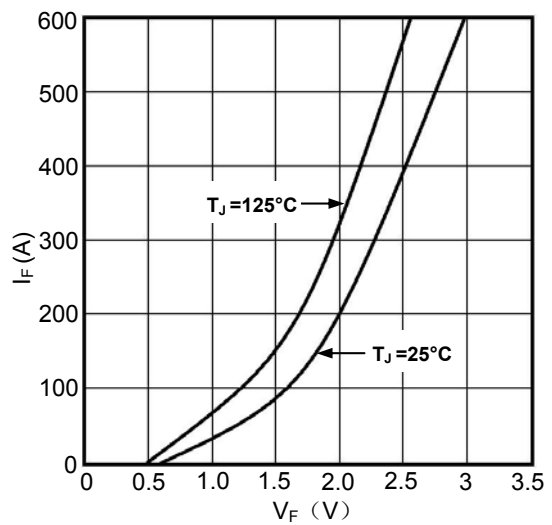

Figure12. Diode Forward Characteristics

# MIMMG200DR120UA

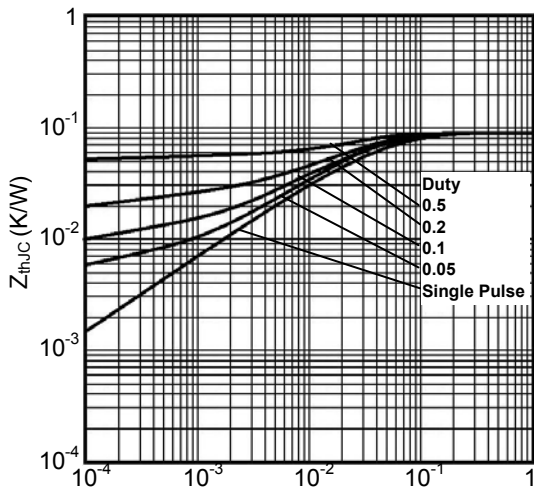

Figure13. Transient Thermal Impedance of IGBT

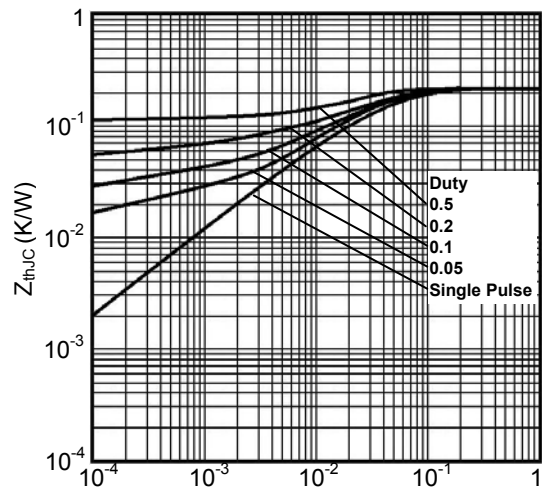

Figure14. Transient Thermal Impedance of Diode

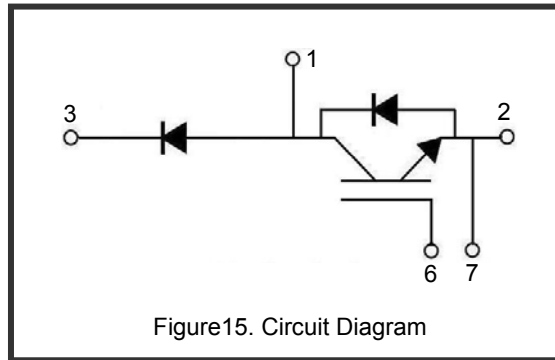
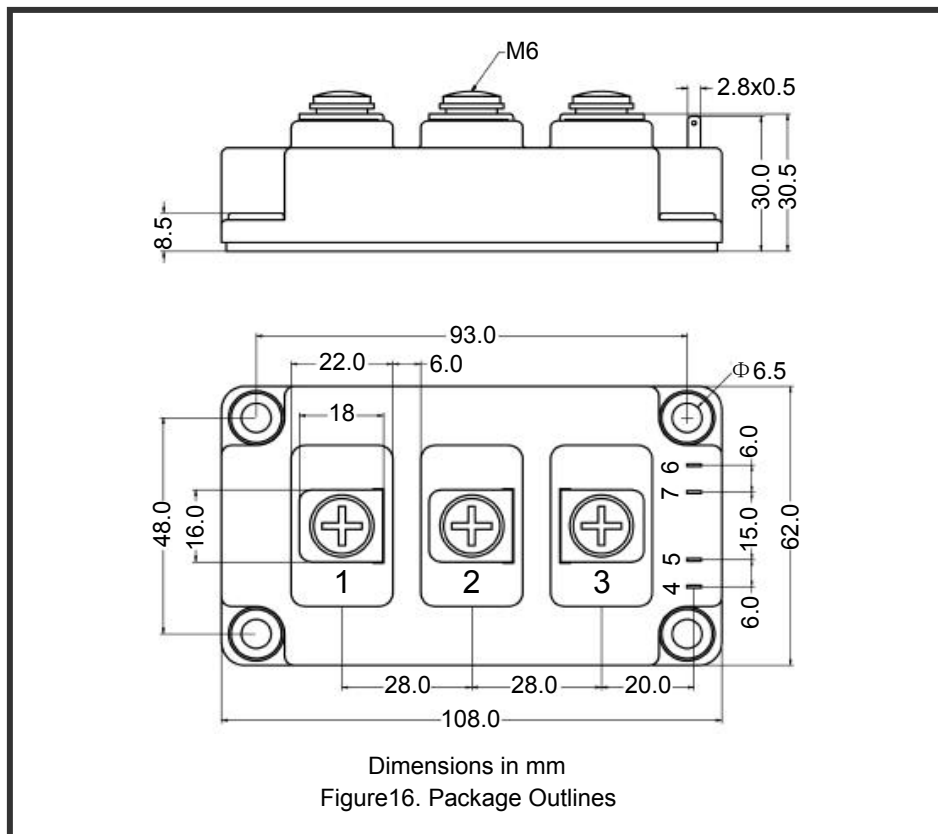

Figure15. Circuit Diagram



Dimensions in mm  
Figure16. Package Outlines