



P-Channel Enhancement Mode Field Effect Transistor

PRODUCT SUMMARY

V _{DSS}	I _D	R _{DS(ON)} (mΩ) Max
-30V	-8A	12.5 @ V _{GS} =-10V
		18 @ V _{GS} =-4.5V

FEATURES

- Super high dense cell design for low R_{DS(ON)}.
- Rugged and reliable.
- Surface Mount Package.
- ESD Protected.

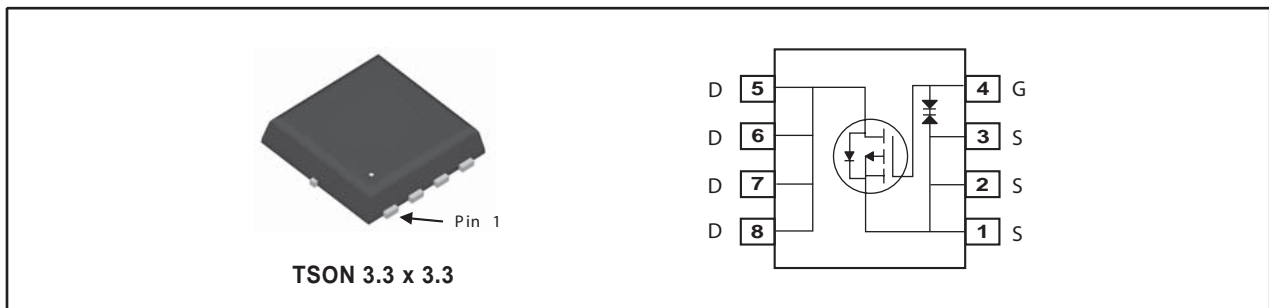

ABSOLUTE MAXIMUM RATINGS (T_A=25°C unless otherwise noted)

Symbol	Parameter	Limit	Units
V _{DS}	Drain-Source Voltage	-30	V
V _{GS}	Gate-Source Voltage	±20	V
I _D	Drain Current-Continuous ^{a c}	T _A =25°C	-8
		T _A =70°C	-6.4
I _{DM}	-Pulsed ^c	-46	A
E _{AS}	Single Pulse Avalanche Energy ^d	30	mJ
P _D	Maximum Power Dissipation ^a	T _A =25°C	1.67
		T _A =70°C	1.07
T _J , T _{STG}	Operating Junction and Storage Temperature Range	-55 to 150	°C

THERMAL CHARACTERISTICS

R _{θJA}	Thermal Resistance, Junction-to-Ambient	75	°C/W
------------------	---	----	------

SP4401

Ver 1.0

ELECTRICAL CHARACTERISTICS (T_A=25°C unless otherwise noted)

Symbol	Parameter	Conditions	Min	Typ	Max	Units
OFF CHARACTERISTICS						
BV _{DSS}	Drain-Source Breakdown Voltage	V _{GS} =0V, I _D =-250uA	-30			V
I _{DSS}	Zero Gate Voltage Drain Current	V _{DS} =-24V, V _{GS} =0V			-1	uA
I _{GSS}	Gate-Body Leakage Current	V _{GS} = ±20V, V _{DS} =0V			±10	uA
ON CHARACTERISTICS						
V _{GS(th)}	Gate Threshold Voltage	V _{DS} =V _{GS} , I _D =-250uA	-1.0	-1.6	-3.0	V
R _{DS(ON)}	Drain-Source On-State Resistance	V _{GS} =-10V, I _D =-4A		10	12.5	m ohm
		V _{GS} =-4.5V, I _D =-3A		13	18	m ohm
g _{FS}	Forward Transconductance	V _{DS} =-10V, I _D =-4A		24		S
DYNAMIC CHARACTERISTICS^b						
C _{ISS}	Input Capacitance	V _{DS} =-15V, V _{GS} =0V f=1.0MHz		3545		pF
C _{OSS}	Output Capacitance			394		pF
C _{RSS}	Reverse Transfer Capacitance			289		pF
SWITCHING CHARACTERISTICS^b						
t _{D(ON)}	Turn-On Delay Time	V _{DD} =-15V I _D =-1A V _{GS} =-10V R _{GEN} = 6 ohm		58		ns
t _r	Rise Time			50		ns
t _{D(OFF)}	Turn-Off Delay Time			176		ns
t _f	Fall Time			45		ns
Q _g	Total Gate Charge	V _{DS} =-15V, I _D =-4A, V _{GS} =-10V		59		nC
		V _{DS} =-15V, I _D =-4A, V _{GS} =-4.5V		28		nC
Q _{gs}	Gate-Source Charge	V _{DS} =-15V, I _D =-4A,		5		nC
Q _{gd}	Gate-Drain Charge	V _{GS} =-10V		14		nC
DRAIN-SOURCE DIODE CHARACTERISTICS						
V _{SD}	Diode Forward Voltage	V _{GS} =0V, I _S =-1A		-0.8	-1.2	V

Notes

- Surface Mounted on FR4 Board of 1 inch², 1oz.
- Guaranteed by design, not subject to production testing.
- Drain current limited by maximum junction temperature.
- Starting T_J=25°C, L=0.5mH, V_{DD} = 20V. (See Figure13)

Jan,29,2014

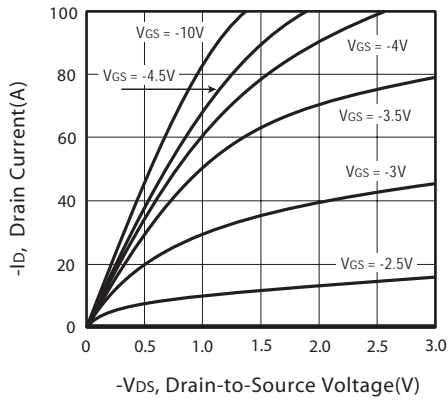

Figure 1. Output Characteristics

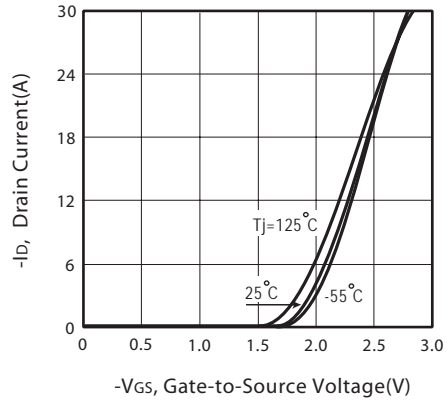

Figure 2. Transfer Characteristics

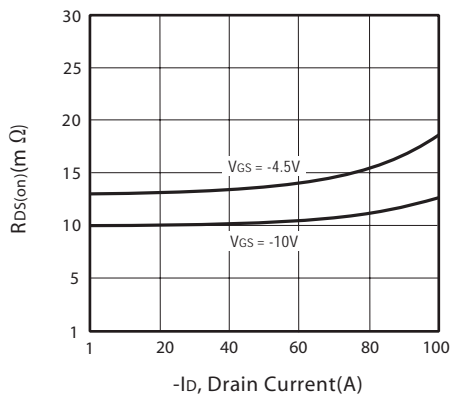

Figure 3. On-Resistance vs. Drain Current and Gate Voltage

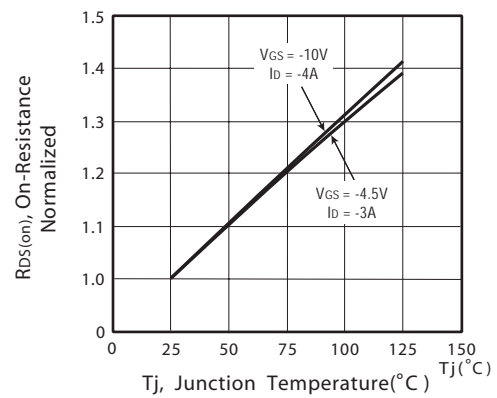

Figure 4. On-Resistance Variation with Drain Current and Temperature

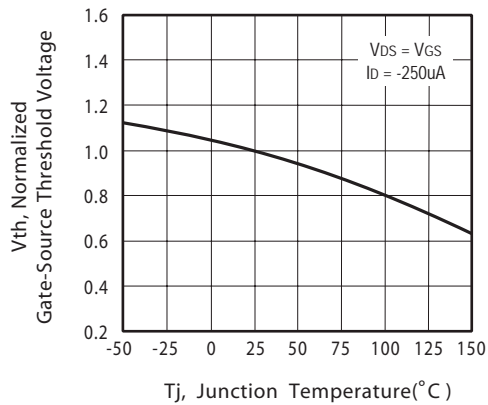

Figure 5. Gate Threshold Variation with Temperature

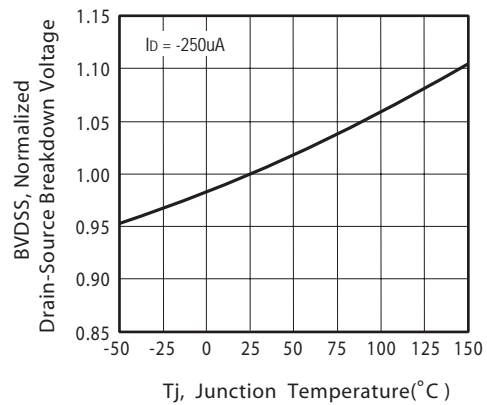

Figure 6. Breakdown Voltage Variation with Temperature

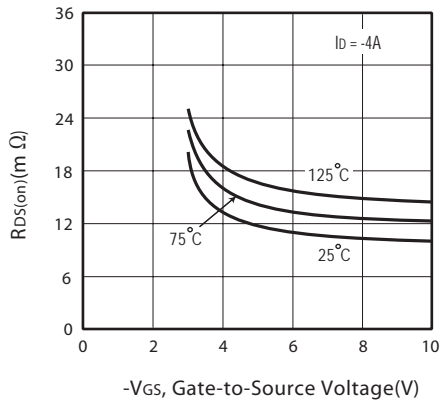

Figure 7. On-Resistance vs. Gate-Source Voltage

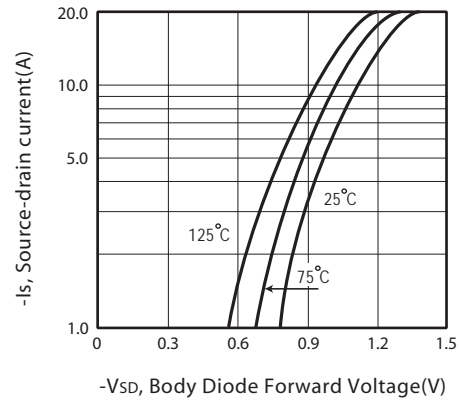

Figure 8. Body Diode Forward Voltage Variation with Source Current

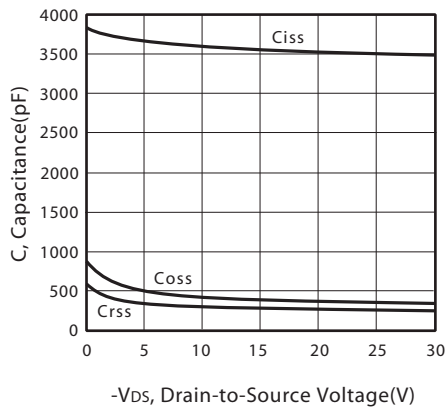

Figure 9. Capacitance

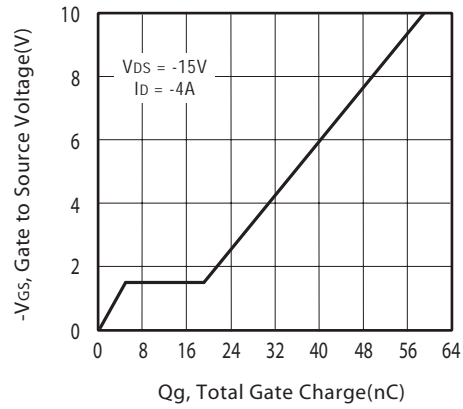

Figure 10. Gate Charge

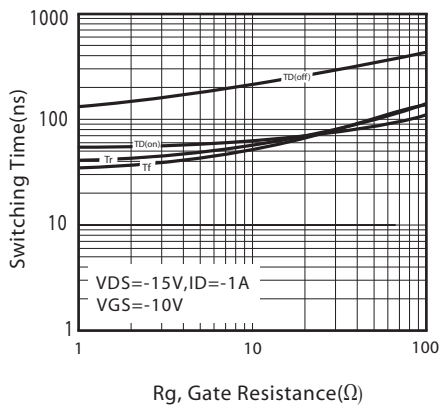

Figure 11. switching characteristics

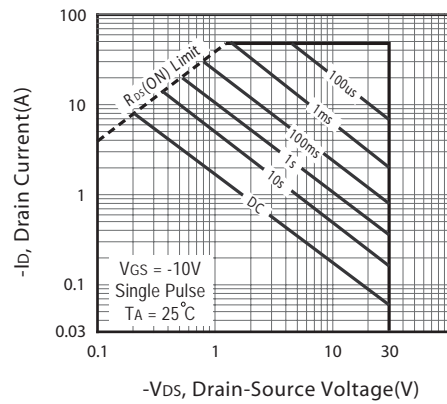
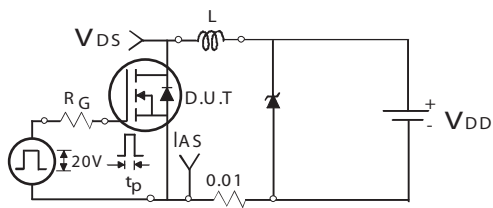
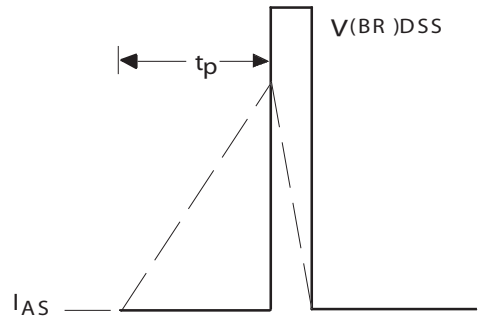

Figure 12. Maximum Safe Operating Area



Unclamped Inductive Test Circuit

Figure 13a.



Unclamped Inductive Waveforms

Figure 13b.

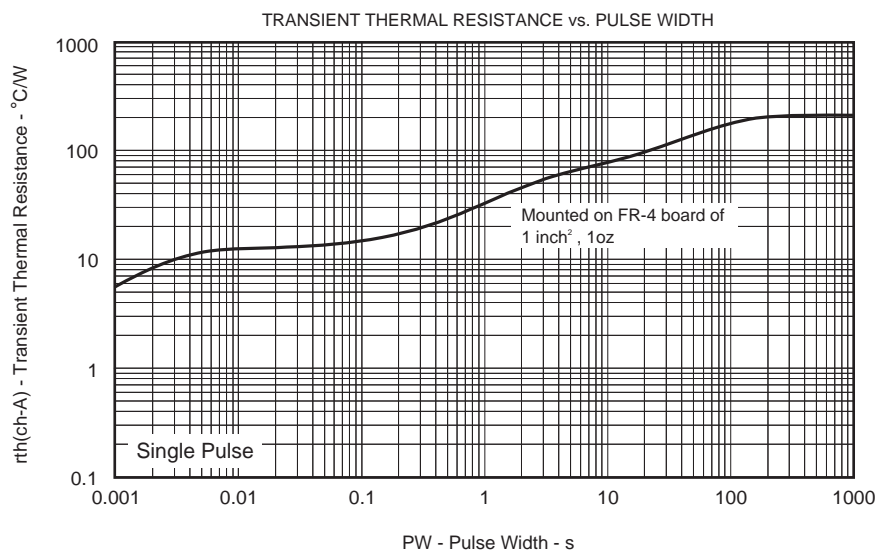

PACKAGE OUTLINE DIMENSIONS

TSON 3.3 x 3.3

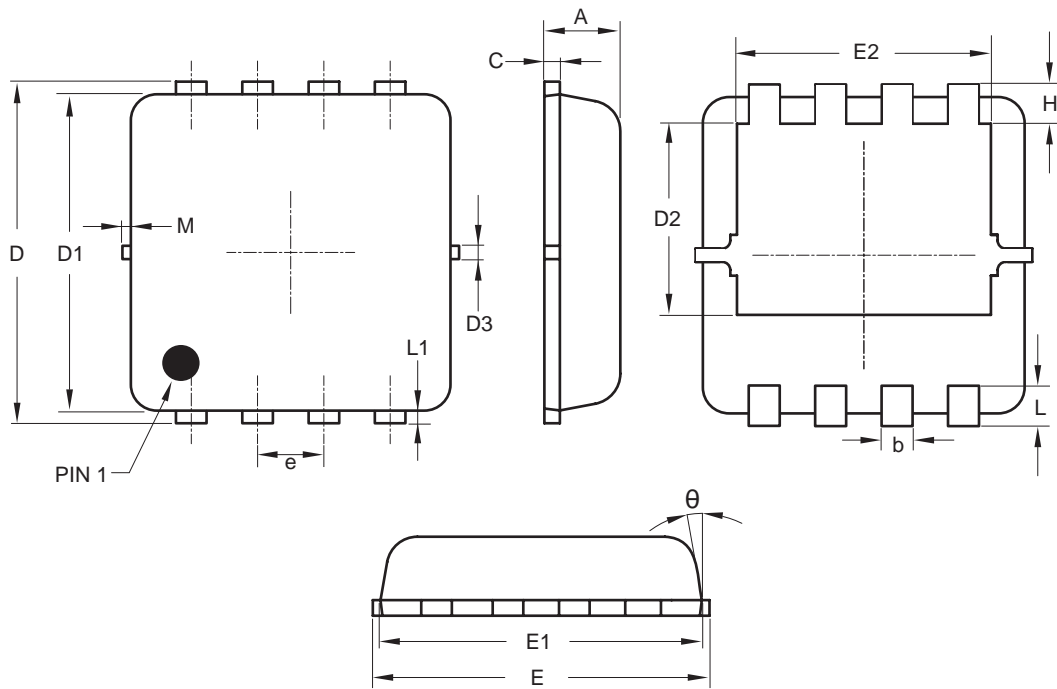

SYMBOLS	MILLIMETERS		
	MIN.	NOM.	MAX.
A	0.70	0.75	0.80
b	0.25	0.30	0.35
C	0.10	0.15	0.25
D	3.25	3.35	3.45
D1	3.00	3.10	3.20
D2	1.78	1.88	1.98
D3	—	0.13	—
E	3.20	3.30	3.40
E1	3.00	3.15	3.20
E2	2.39	2.49	2.59
e	0.65 BSC		
H	0.30	0.39	0.50
L	0.30	0.40	0.50
L1	—	0.13	—
M	—	—	0.15
θ	—	10°	12°

TSON 3.3 x 3.3 Tape and Reel Data

TSON 3.3 x 3.3 Tape

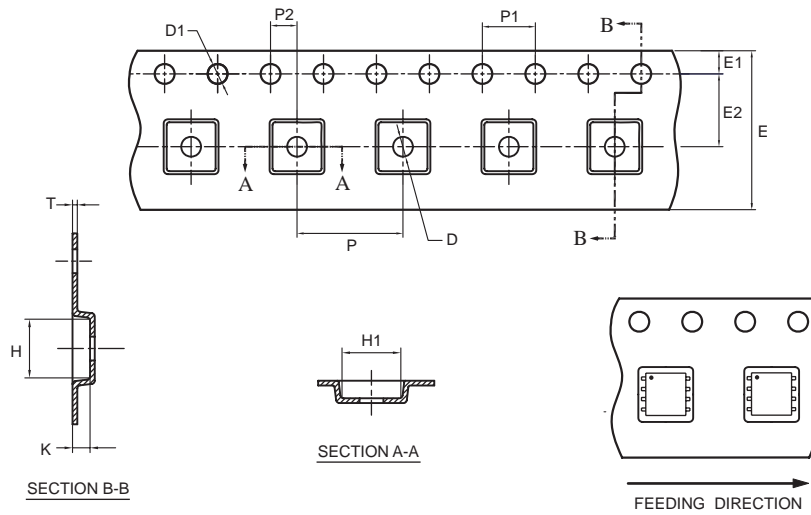

unit:mm

PACKAGE	D	D1	E	E1	E2	H	H1	K	P	P1	P2	T
S mini 8	$\phi 1.50$ (MIN)	$\phi 1.50$ +0.10 -0.00	12.0 +0.30 -0.10	1.75 ± 0.10	5.50 ± 0.05	3.70 ± 0.10	3.70 ± 0.10	1.10 ± 0.10	8.0 ± 0.10	4.0 ± 0.10	2.0 ± 0.05	0.3 ± 0.05

TSON 3.3 x 3.3 Reel

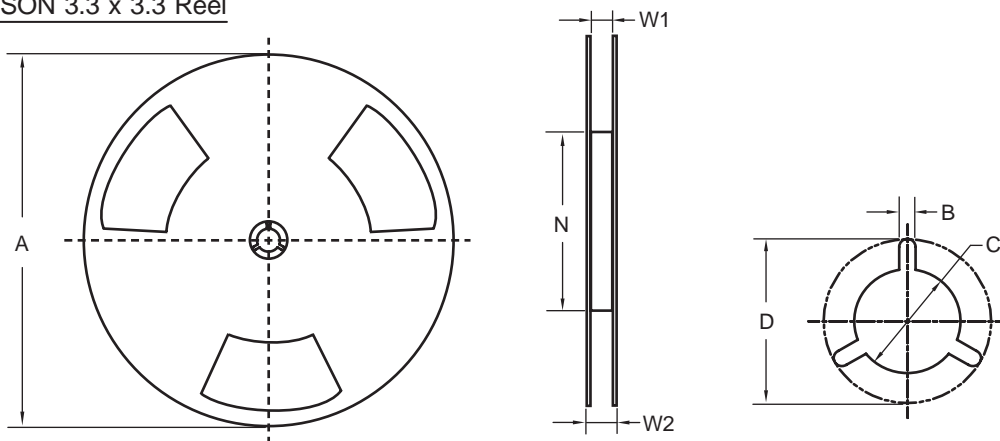

UNIT:mm

TAPE SIZE	REEL SIZE	A	B	C	D	N	W1	W2
12 mm	13 "	330 ± 1.0	1.5 $\begin{smallmatrix} +0.5 \\ -0.2 \end{smallmatrix}$	$\phi 13.0$ $\begin{smallmatrix} +0.5 \\ -0.2 \end{smallmatrix}$	20.2(ref.)	178 $\begin{smallmatrix} +0.0 \\ -2.0 \end{smallmatrix}$	12.4 $\begin{smallmatrix} +2.0 \\ -0.0 \end{smallmatrix}$	18.4(ref.)

TOP MARKING DEFINITION

