



P-Channel Enhancement Mode Field Effect Transistor

PRODUCT SUMMARY

V _{DSS}	I _D	R _{DS(ON)} (mΩ) Max
-20V	-4.2A	46 @ V _{GS} =-4.5V
		47 @ V _{GS} =-4.0V
		49 @ V _{GS} =-3.7V
		54 @ V _{GS} =-3.1V
		61 @ V _{GS} =-2.5V

FEATURES

- Super high dense cell design for low R_{DS(ON)}.
- Rugged and reliable.
- Surface Mount Package.
- ESD Protected.



ABSOLUTE MAXIMUM RATINGS (T_A=25°C unless otherwise noted)

Symbol	Parameter	Limit	Units	
V _{DS}	Drain-Source Voltage	-20	V	
V _{GS}	Gate-Source Voltage	±10	V	
I _D	Drain Current-Continuous ^a	T _A =25°C	-4.2	A
		T _A =70°C	-3.4	A
I _{DM}	-Pulsed ^b	-16	A	
P _D	Maximum Power Dissipation ^a	T _A =25°C	1.25	W
		T _A =70°C	0.8	W
T _J , T _{STG}	Operating Junction and Storage Temperature Range	-55 to 150	°C	

THERMAL CHARACTERISTICS

Symbol	Parameter	Limit	Units
R _{θJA}	Thermal Resistance, Junction-to-Ambient ^a	100	°C/W

STS3415

Ver 2.0

ELECTRICAL CHARACTERISTICS (TA=25°C unless otherwise noted)

Symbol	Parameter	Conditions	Min	Typ	Max	Units
OFF CHARACTERISTICS						
BV _{DSS}	Drain-Source Breakdown Voltage	V _{GS} =0V , I _D =-250uA	-20			V
I _{DSS}	Zero Gate Voltage Drain Current	V _{DS} =-16V , V _{GS} =0V			1	uA
I _{GSS}	Gate-Body Leakage Current	V _{GS} = ±10V , V _{DS} =0V			±10	uA
ON CHARACTERISTICS						
V _{GS(th)}	Gate Threshold Voltage	V _{DS} =V _{GS} , I _D =-1mA	-0.5	-0.7	-1.5	V
R _{DS(ON)}	Drain-Source On-State Resistance	V _{GS} =-4.5V , I _D =-2.1A	28	35	46	m ohm
		V _{GS} =-4.0V , I _D =-2.1A	29	36	47	m ohm
		V _{GS} =-3.7V , I _D =-2.1A	30	37	49	m ohm
		V _{GS} =-3.1V , I _D =-2.1A	32	40	54	m ohm
		V _{GS} =-2.5V , I _D =-2.1A	35	45	61	m ohm
g _{FS}	Forward Transconductance	V _{DS} =-5V , I _D =-2.1A		11		S
DYNAMIC CHARACTERISTICS ^c						
C _{ISS}	Input Capacitance	V _{DS} =-10V, V _{GS} =0V f=1.0MHz		613		pF
C _{OSS}	Output Capacitance			159		pF
C _{RSS}	Reverse Transfer Capacitance			141		pF
SWITCHING CHARACTERISTICS ^c						
t _{D(ON)}	Turn-On Delay Time	V _{DD} =-16V I _D =-2.1A V _{GS} =-4.5V R _{GEN} = 6 ohm		85		ns
t _r	Rise Time			225		ns
t _{D(OFF)}	Turn-Off Delay Time			1310		ns
t _f	Fall Time			605		ns
Q _g	Total Gate Charge				11.8	
Q _{gs}	Gate-Source Charge	V _{DS} =-16V, I _D =-4.2A, V _{GS} =-4.5V		0.85		nC
Q _{gd}	Gate-Drain Charge			4.7		nC
DRAIN-SOURCE DIODE CHARACTERISTICS AND MAXIMUM RATINGS						
V _{SD}	Diode Forward Voltage	V _{GS} =0V, I _S =-1.1A		-0.8	-1.2	V
Notes						
<p>a.Surface Mounted on FR4 Board, t ≤ 10sec.</p> <p>b.Pulse Test:Pulse Width ≤ 10us, Duty Cycle ≤ 1%.</p> <p>c.Guaranteed by design, not subject to production testing.</p>						

May,22,2012

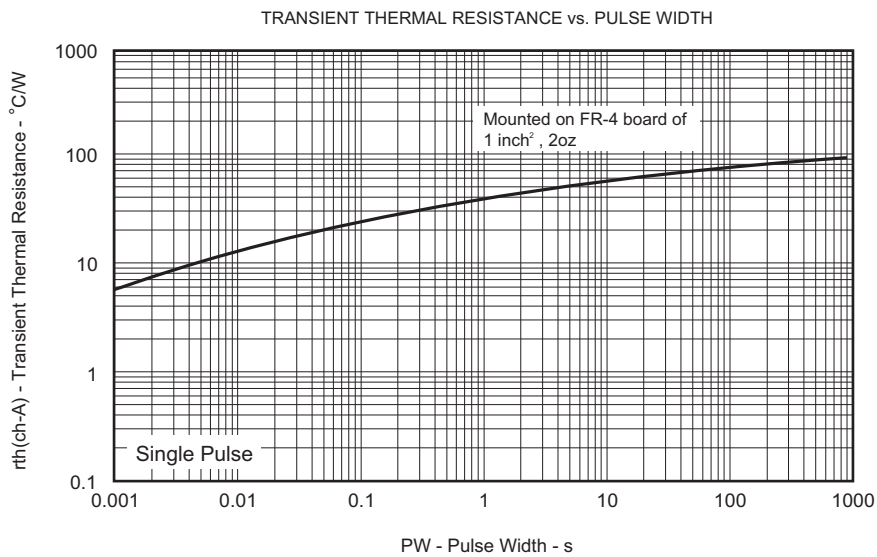
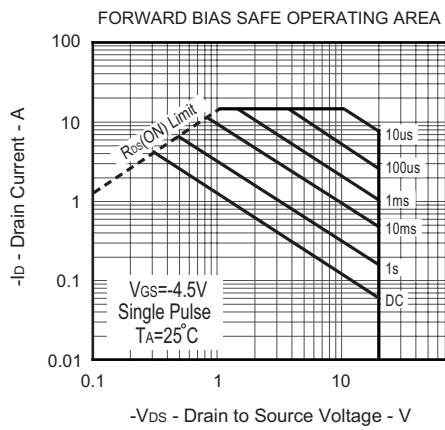
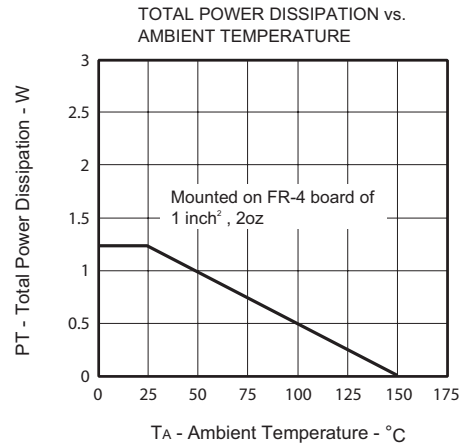
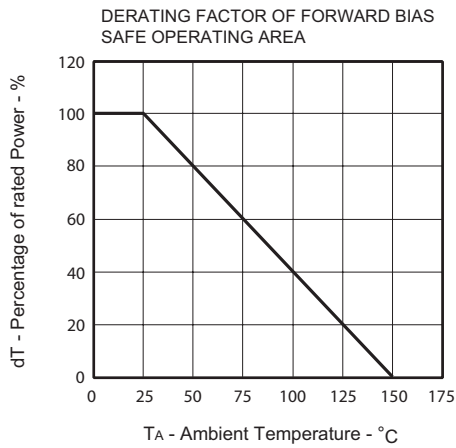

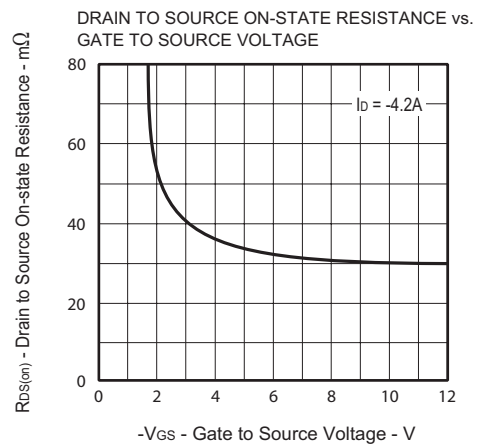
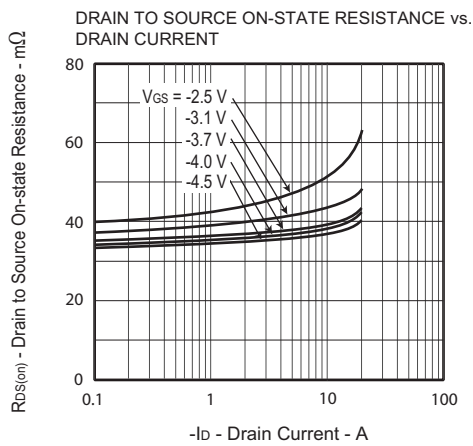
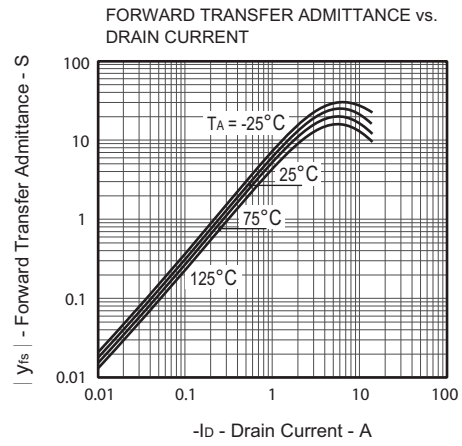
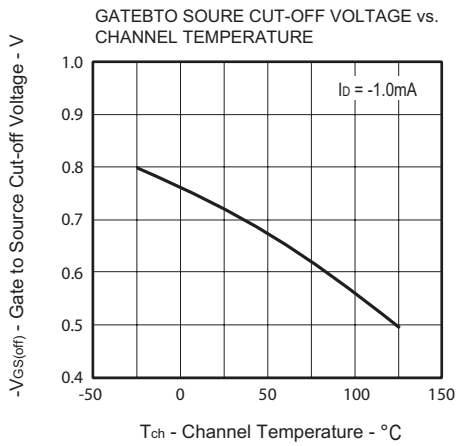
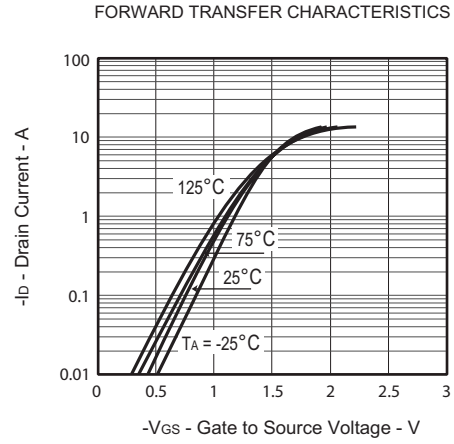
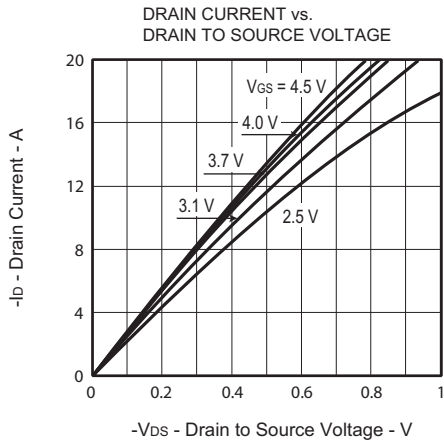

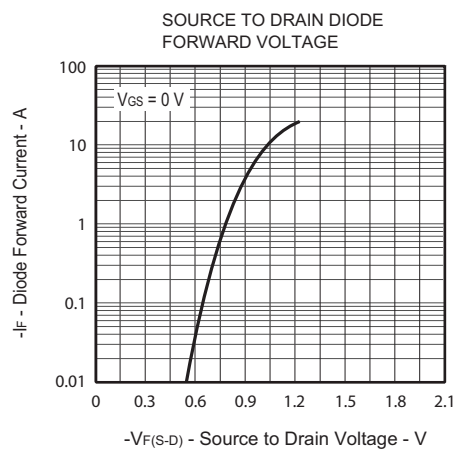
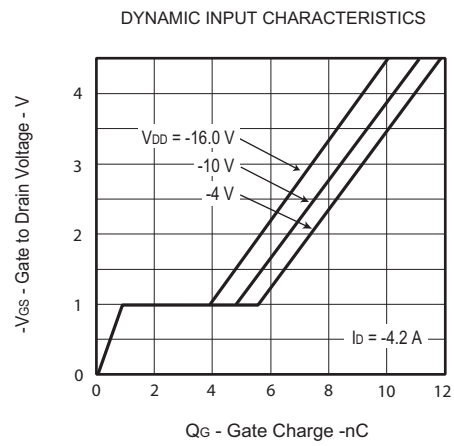
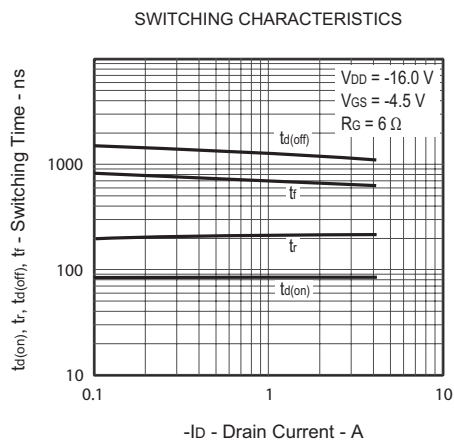
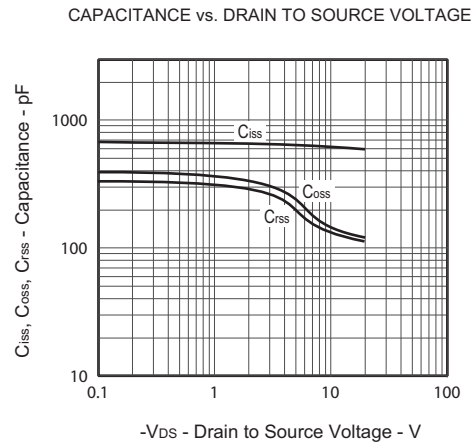
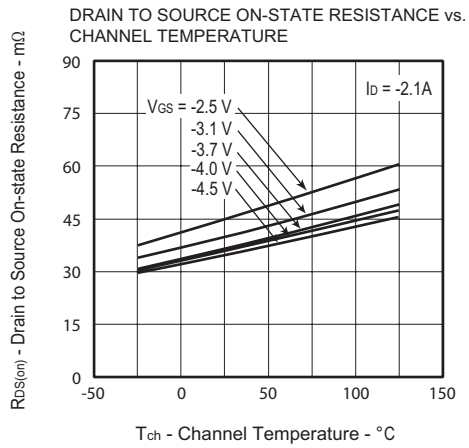

PACKAGE OUTLINE DIMENSIONS

SOT 23

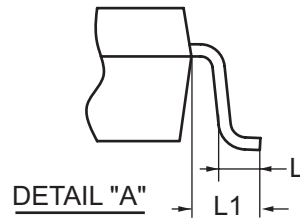
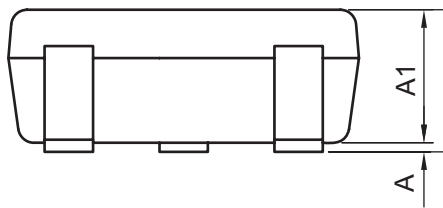
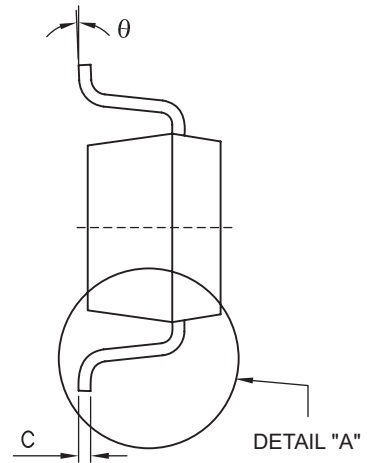
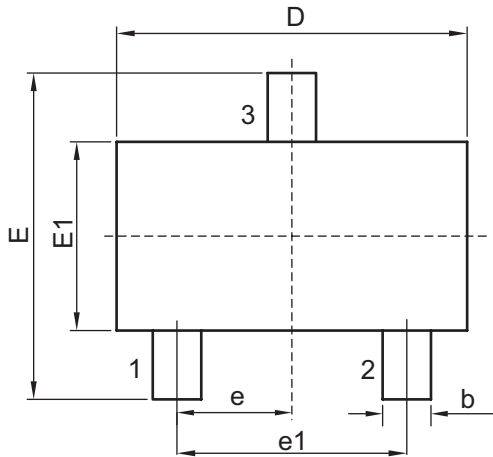

SYMBOLS	MILLIMETERS		INCHES	
	MIN	MAX	MIN	MAX
D	2.700	3.100	0.106	0.122
E	2.200	3.000	0.087	0.118
E1	1.200	1.700	0.047	0.067
e	0.850	1.150	0.033	0.045
e1	1.800	2.100	0.071	0.083
b	0.300	0.510	0.019	0.020
C	0.080	0.200	0.003	0.008
A	0.000	0.150	0.000	0.006
A1	0.887	1.300	0.035	0.051
L	0.450 REF.		0.018 REF.	
L1	0.600 REF.		0.024 REF.	
θ	0°	10°	0°	10°

SOT23 Tape and Reel Data

SOT23-3L Carrier Tape

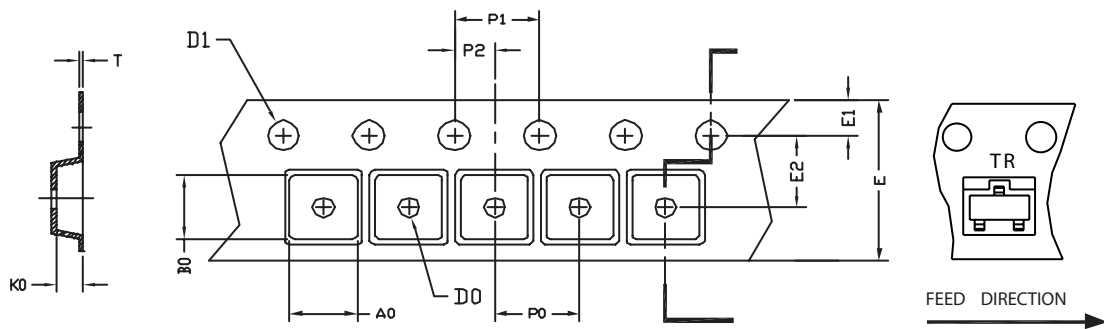

UNIT:mm

PACKAGE	A0	B0	K0	D0	D1	E	E1	E2	P0	P1	P2	T
SOT23-3L	3.15 ±0.10	2.77 ±0.10	1.22 ±0.10	1.00 +0.05	1.50 +0.10	8.00 +0.30 -0.10	1.75 ±0.10	3.50 ±0.05	4.00 ±0.10	4.00 ±0.10	2.00 ±0.05	0.22 ±0.04

SOT23-3L Reel

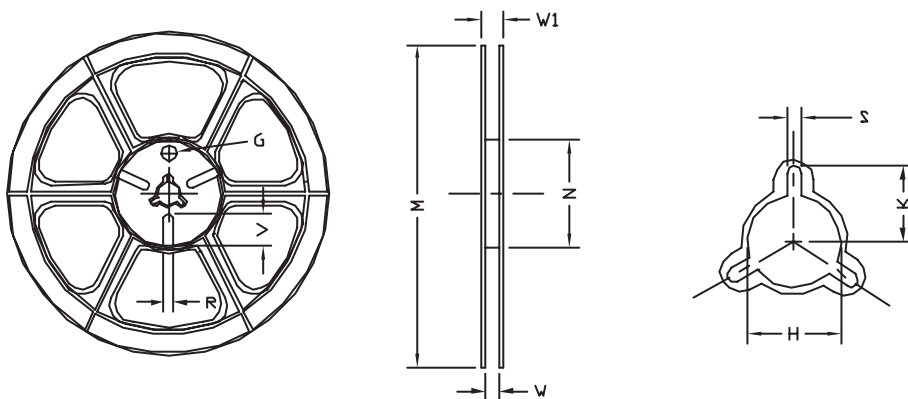

UNIT:mm

TAPE SIZE	REEL SIZE	M	N	W	W1	H	K	S	G	R	V
8mm	178	178 ±1	60 ±1	9.00 ±0.5	12.00 ±0.5	13.5 ±0.5	10.5	2.00 ±0.5	10.0	5.00	18.00