



N-Channel Logic Level Enhancement Mode Field Effect Transistor

PRODUCT SUMMARY

VDSS	ID	RDS(ON) (mΩ) Max
100V	3A	140 @ VGS=10V
		225 @ VGS=4.5V

FEATURES

- Super high dense cell design for low RDS(ON).
- Rugged and reliable.
- Surface Mount Package.

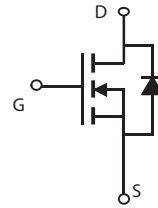
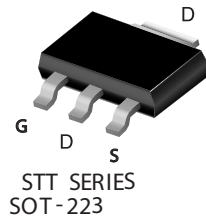

ABSOLUTE MAXIMUM RATINGS (TA=25°C unless otherwise noted)

Symbol	Parameter	Limit	Units	
V _{DS}	Drain-Source Voltage	100	V	
V _{GS}	Gate-Source Voltage	±20	V	
I _D	Drain Current-Continuous ^a	T _A =25°C	3.0	A
		T _A =70°C	2.4	A
I _{DM}	-Pulsed ^b	20	A	
E _{AS}	Single Pulse Avalanche Energy ^d	16	mJ	
P _D	Maximum Power Dissipation ^a	T _A =25°C	3	W
		T _A =70°C	1.9	W
T _J , T _{STG}	Operating Junction and Storage Temperature Range	-55 to 150	°C	

THERMAL CHARACTERISTICS

R _{θJA}	Thermal Resistance, Junction-to-Ambient ^a	42	°C/W
------------------	--	----	------

STT10L01

Ver 1.0

ELECTRICAL CHARACTERISTICS (T_A=25°C unless otherwise noted)

Symbol	Parameter	Conditions	Min	Typ	Max	Units
OFF CHARACTERISTICS						
BV _{DSS}	Drain-Source Breakdown Voltage	V _{GS} =0V , I _D =250uA	100			V
I _{DSS}	Zero Gate Voltage Drain Current	V _{DS} =80V , V _{GS} =0V			1	uA
I _{GSS}	Gate-Body Leakage Current	V _{GS} = ±20V , V _{DS} =0V			±100	nA
ON CHARACTERISTICS						
V _{GS(th)}	Gate Threshold Voltage	V _{DS} =V _{GS} , I _D =250uA	1	1.5	3	V
R _{DS(ON)}	Drain-Source On-State Resistance	V _{GS} =10V , I _D =3A		112	140	m ohm
		V _{GS} =4.5V , I _D =2.4A		167	225	m ohm
g _{FS}	Forward Transconductance	V _{DS} =5V , I _D =3A		4		S
DYNAMIC CHARACTERISTICS [°]						
C _{ISS}	Input Capacitance	V _{DS} =25V, V _{GS} =0V f=1.0MHz		455		pF
C _{OSS}	Output Capacitance			48		pF
C _{RSS}	Reverse Transfer Capacitance			32		pF
SWITCHING CHARACTERISTICS [°]						
t _{D(ON)}	Turn-On Delay Time	V _{DD} =50V I _D =1A V _{GS} =10V R _{GEN} = 6 ohm		10.5		ns
t _r	Rise Time			11		ns
t _{D(OFF)}	Turn-Off Delay Time			20		ns
t _f	Fall Time			6.8		ns
Q _g	Total Gate Charge		V _{DS} =50V, I _D =3A, V _{GS} =10V		8	
		V _{DS} =50V, I _D =3A, V _{GS} =4.5V		4.5		nC
Q _{gs}	Gate-Source Charge	V _{DS} =50V, I _D =3A,		1.2		nC
Q _{gd}	Gate-Drain Charge	V _{GS} =10V		2.6		nC
DRAIN-SOURCE DIODE CHARACTERISTICS AND MAXIMUM RATINGS						
V _{SD}	Diode Forward Voltage ^b	V _{GS} =0V, I _S =1A		0.78	1.2	V
Notes						
<p>a.Surface Mounted on FR4 Board, t ≤ 10sec.</p> <p>b.Pulse Test:Pulse Width ≤ 300us, Duty Cycle ≤ 2%.</p> <p>c.Guaranteed by design, not subject to production testing.</p> <p>d.Starting T_J=25°C, L=0.5mH, V_{DD} = 50V.(See Figure13)</p>						

Aug,05,2010

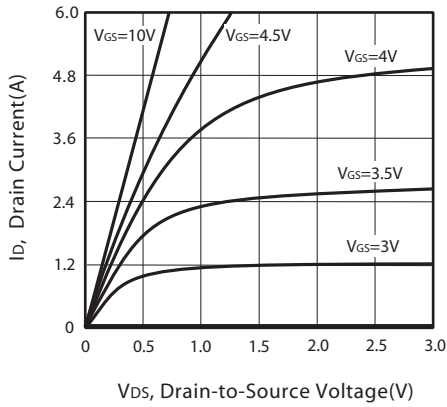

Figure 1. Output Characteristics

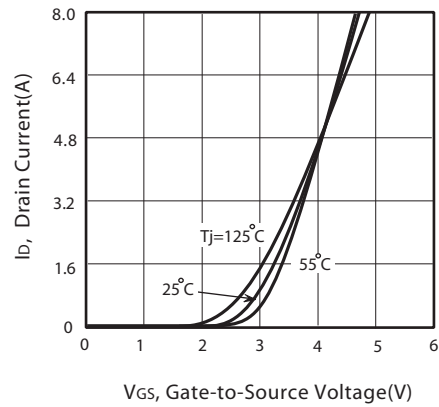

Figure 2. Transfer Characteristics

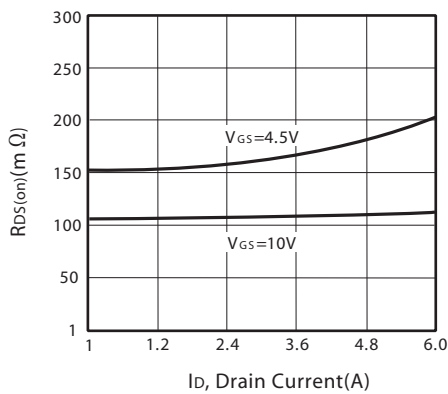

Figure 3. On-Resistance vs. Drain Current and Gate Voltage

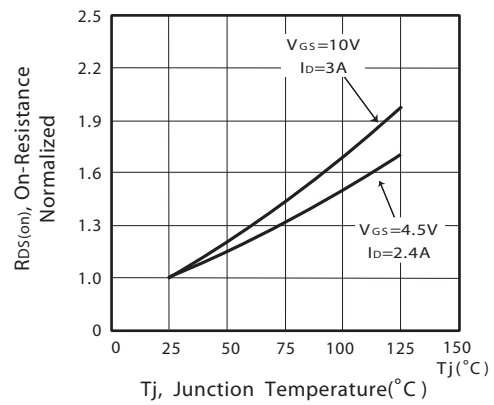

Figure 4. On-Resistance Variation with Drain Current and Temperature

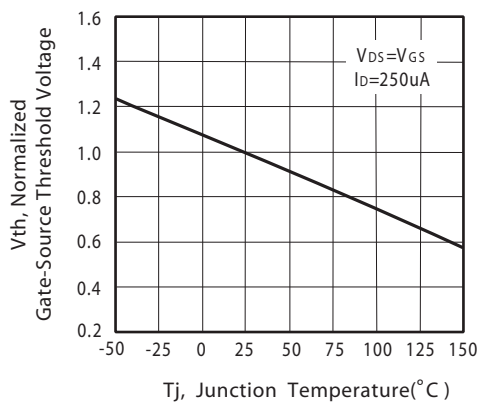

Figure 5. Gate Threshold Variation with Temperature

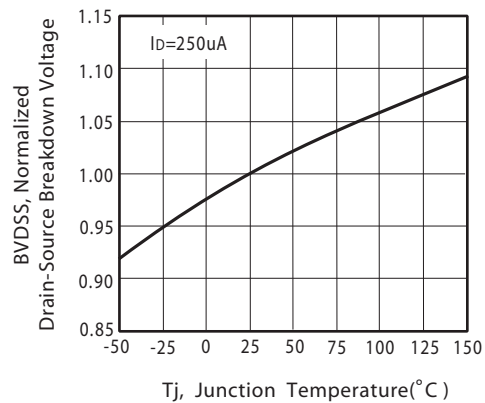

Figure 6. Breakdown Voltage Variation with Temperature

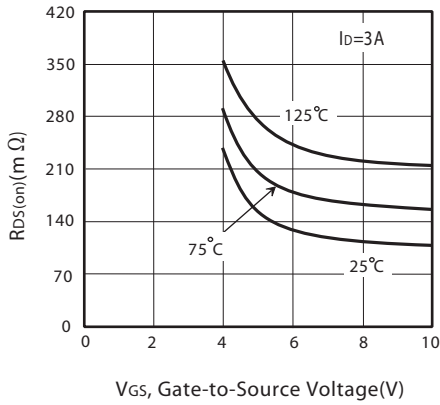

Figure 7. On-Resistance vs. Gate-Source Voltage

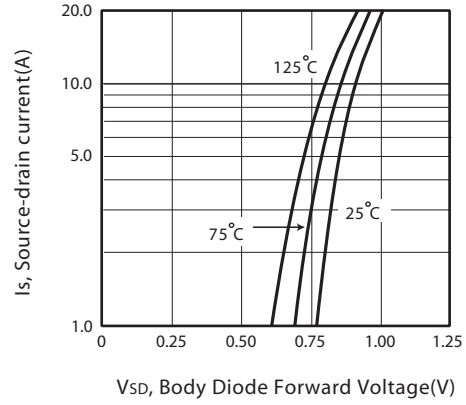

Figure 8. Body Diode Forward Voltage Variation with Source Current

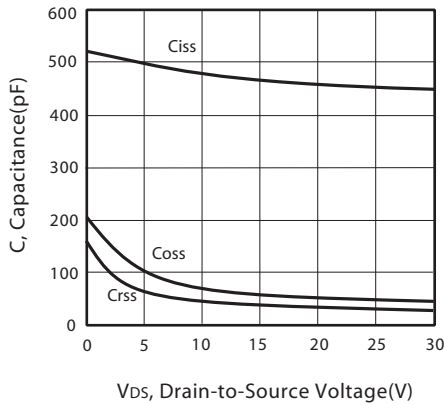

Figure 9. Capacitance

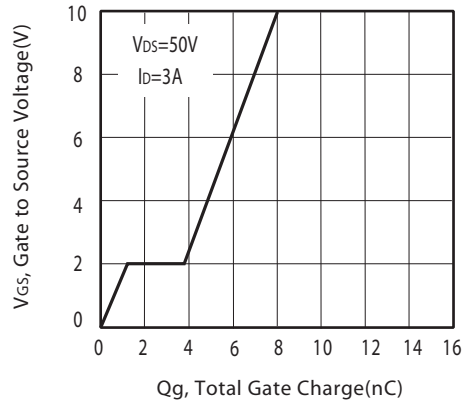

Figure 10. Gate Charge

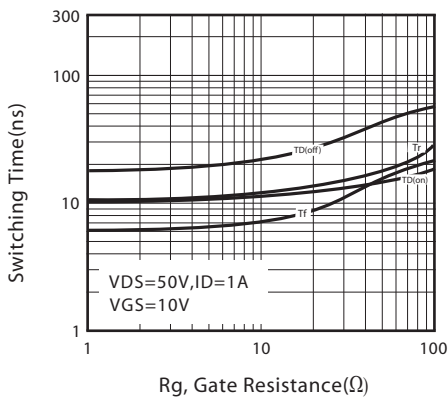

Figure 11. switching characteristics

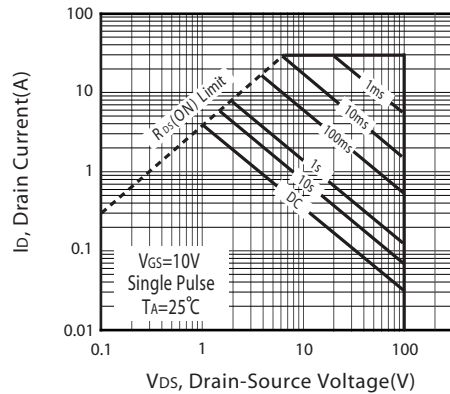
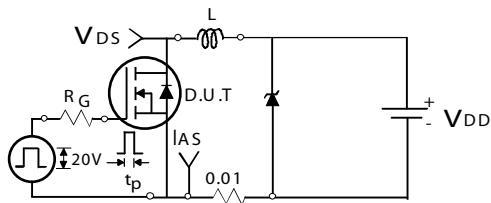
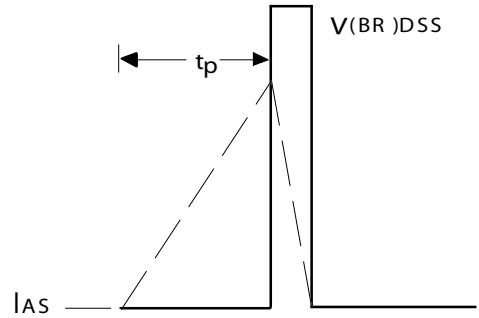

Figure 12. Maximum Safe Operating Area



Unclamped Inductive Test Circuit

Figure 13a.



Unclamped Inductive Waveforms

Figure 13b.

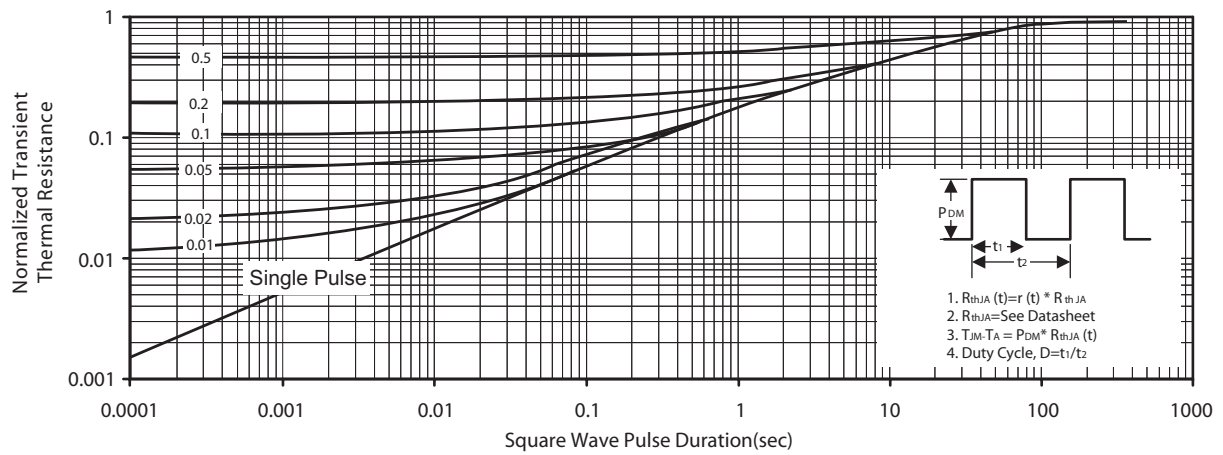
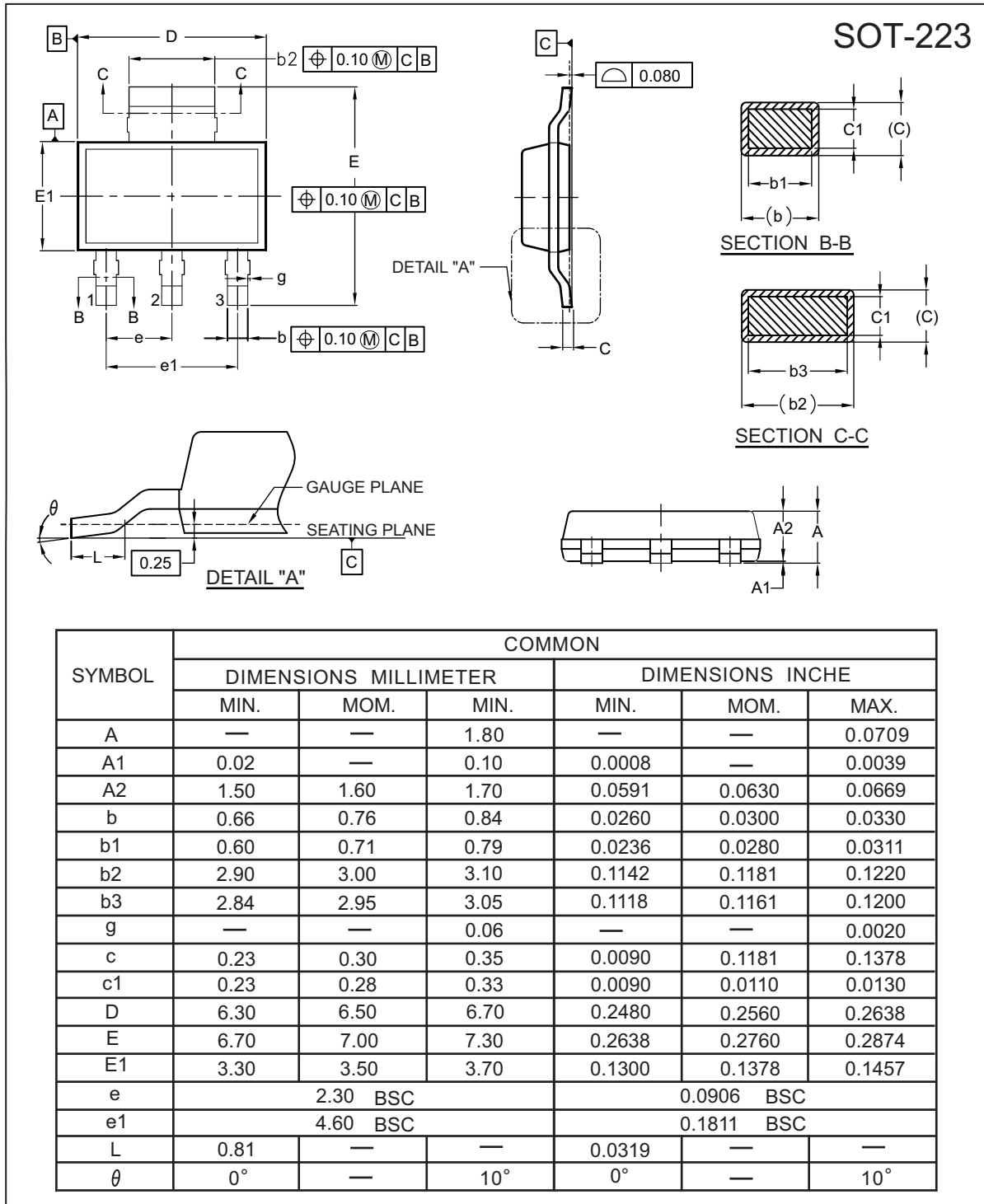

Figure 14. Normalized Thermal Transient Impedance Curve

STT10L01

Ver 1.0



Aug,05,2010

SOT-223 Tape and Reel Data

SOT-223 Carrier Tape

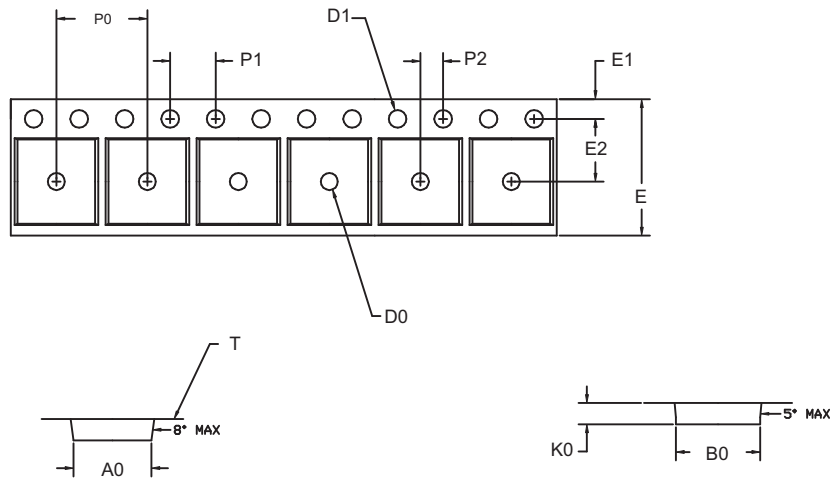

unit:mm

PACKAGE	A0	B0	K0	D0	D1	E	E1	E2	P0	P1	P2	T
---	6.83 ±0.1	7.42 ±0.1	1.88 ±0.1	1.50 + 0.25	1.60 + 0.1	12.0 + 0.3 - 0.1	1.75 ±0.1	5.50 ±0.5	8.0 ±0.1	4.00 ±0.1	2.00 ±0.05	0.292 ±0.02

SOT-223 Reel

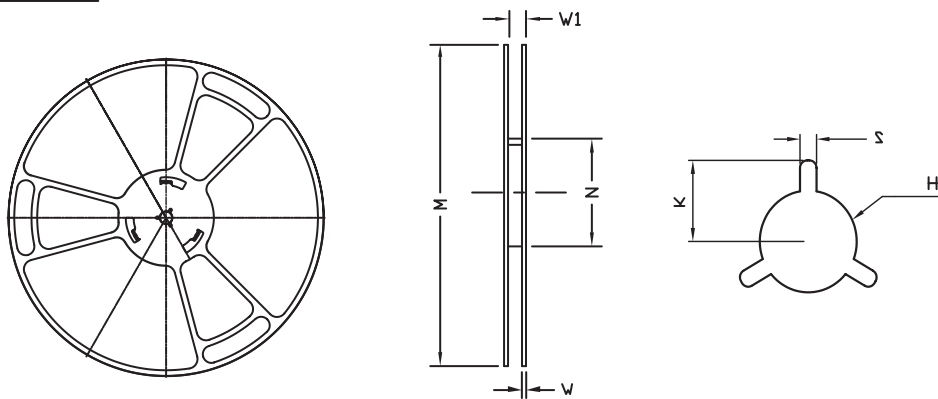

UNIT:mm

REEL SIZE	M	N	W	W1	H	K	S	G	R	V
φ 330 ± 0.5	---	φ 97.0 ± 1.0	2.2	13.0 + 1.5	φ 13.0 + 0.5 - 0.2	10.6	2.0 ±0.5	---	---	---