

Product Summary

$V_{(BR)DSS}$	$R_{DS(ON)}$	I_D $T_C = +25^\circ\text{C}$
-20V	1.9m Ω @ $V_{GS} = -10\text{V}$	-60A
	2.4m Ω @ $V_{GS} = -4.5\text{V}$	-60A
	3.8m Ω @ $V_{GS} = -2.5\text{V}$	-60A

Description

This new generation P-Channel Enhancement Mode MOSFET is designed to minimize $R_{DS(ON)}$ and yet maintain superior switching performance. This device is ideal for use in notebook battery power management and load switch.

Applications

- Switch

Features

- Thermally Efficient Package-Cooler Running Applications
- High Conversion Efficiency
- Low $R_{DS(ON)}$ – Minimizes On State Losses
- <1.1mm Package Profile – Ideal for Thin Applications
- Lead-Free Finish; RoHS Compliant (Notes 1 & 2)**
- Halogen and Antimony Free. "Green" Device (Note 3)**
- Qualified to AEC-Q101 Standards for High Reliability**

Mechanical Data

- Case: POWERDI5060-8
- Case Material: Molded Plastic, "Green" Molding Compound; UL Flammability Classification Rating 94V-0
- Moisture Sensitivity: Level 1 per J-STD-020
- Terminal Finish - Matte Tin Annealed over Copper Leadframe; Solderable per MIL-STD-202, Method 208(3)
- Weight: 0.097 grams (Approximate)

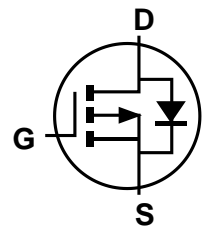
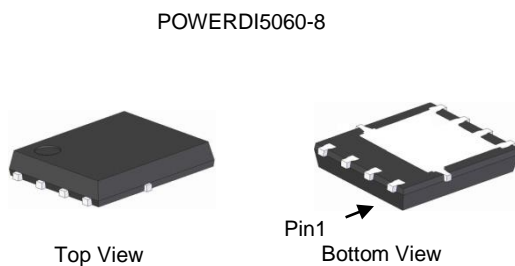

Internal Schematic

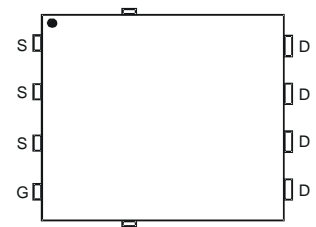

Top View
Pin Configuration

Ordering Information (Note 4)

Part Number	Case	Packaging
DMP2002UPS-13	POWERDI5060-8	2,500 / Tape & Reel

- Notes:
- EU Directive 2002/95/EC (RoHS) & 2011/65/EU (RoHS 2) compliant. All applicable RoHS exemptions applied.
 - See http://www.diodes.com/quality/lead_free.html for more information about Diodes Incorporated's definitions of Halogen- and Antimony-free, "Green" and Lead-free.
 - Halogen- and Antimony-free "Green" products are defined as those which contain <900ppm bromine, <900ppm chlorine (<1500ppm total Br + Cl) and <1000ppm antimony compounds.
 - For packaging details, go to our website at <http://www.diodes.com/products/packages.html>.

Marking Information

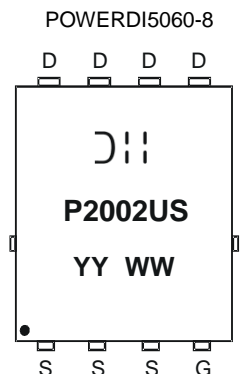

- ⌋|| = Manufacturer's Marking
- P2002US = Product Type Marking Code
- YYWW = Date Code Marking
- YY = Last Digit of Year (ex: 14 = 2014)
- WW = Week Code (01 to 53)

Maximum Ratings (@T_A = +25°C, unless otherwise specified.)

Characteristic			Symbol	Value	Units
Drain-Source Voltage			V _{DSS}	-20	V
Gate-Source Voltage			V _{GSS}	±12	V
Continuous Drain Current, V _{GS} = 10V (Note 5)	Steady State (Note 8)	T _C = +25°C T _C = +70°C	I _D	-60 -60	A
	t < 10s	T _A = +25°C T _A = +70°C		-42 -33.5	A
Pulsed Drain Current (10µs pulse, duty cycle = 1%)			I _{DM}	-100	A
Continuous Body Diode Forward Current (Note 5)	Steady State (Note 8)	T _C = +25°C	I _S	-60	A
	t < 10s	T _A = +25°C		-5.6	A
Avalanche Current, L = 0.1mH			I _{AS}	-37	A
Avalanche Energy, L = 0.1mH			E _{AS}	69.8	mJ

Thermal Characteristics

Characteristic		Symbol	Value	Units
Total Power Dissipation (Note 5)	Steady State	P _D	2.3	W
	t < 10s		6.25	
Thermal Resistance, Junction to Ambient (Note 5)	Steady State	R _{θJA}	55	°C/W
	t < 10s		20	
Total Power Dissipation (Note 5)	Steady State	P _D	104	W
Thermal Resistance, Junction to Case (Note 5)		R _{θJC}	0.9	°C/W
Operating and Storage Temperature Range		T _J , T _{STG}	-55 to +150	°C

Electrical Characteristics (@T_A = +25°C, unless otherwise specified.)

Characteristic	Symbol	Min	Typ	Max	Unit	Test Condition
OFF CHARACTERISTICS (Note 6)						
Drain-Source Breakdown Voltage	BV _{DSS}	-20	—	—	V	V _{GS} = 0V, I _D = -250μA
Zero Gate Voltage Drain Current	I _{DSS}	—	—	-1	μA	V _{DS} = -20V, V _{GS} = 0V
Gate-Source Leakage	I _{GSS}	—	—	±100	nA	V _{GS} = ±12V, V _{DS} = 0V
ON CHARACTERISTICS (Note 6)						
Gate Threshold Voltage	V _{GS(TH)}	-0.5	—	-1.4	V	V _{DS} = V _{GS} , I _D = -250μA
Static Drain-Source On-Resistance	R _{DS(ON)}	—	1.3	1.9	mΩ	V _{GS} = -10V, I _D = -25A
		—	1.5	2.4		V _{GS} = -4.5V, I _D = -20A
		—	2	3.8		V _{GS} = -2.5V, I _D = -15A
DYNAMIC CHARACTERISTICS (Note 7)						
Input Capacitance	C _{iSS}	—	12826	—	pF	V _{DS} = -10V, V _{GS} = 0V f = 1MHz
Output Capacitance	C _{oSS}	—	2547	—		
Reverse Transfer Capacitance	C _{rSS}	—	1924	—		
Gate Resistance	R _G	0.9	4.2	6.6	Ω	V _{DS} = 0V, V _{GS} = 0V, f = 1MHz
Total Gate Charge (V _{GS} = -10V)	Q _g	—	476	585	nC	V _{DS} = -10V, I _D = -20A
Total Gate Charge (V _{GS} = -4.5V)	Q _g	—	228	282		
Gate-Source Charge	Q _{gs}	—	24.8	—		
Gate-Drain Charge	Q _{gd}	—	61.9	—		
Turn-On Delay Time	t _{D(ON)}	—	14.2	28	ns	V _{DD} = -10V, V _{GEN} = -4.5V, R _{GEN} = 1Ω, I _D = -10A
Turn-On Rise Time	t _R	—	35.4	70		
Turn-Off Delay Time	t _{D(OFF)}	—	361	578		
Turn-Off Fall Time	t _F	—	224	358		
BODY DIODE CHARACTERISTICS						
Continuous Body Diode Forward Current (Note 5 & 8)	I _S	—	—	-60	A	T _C = +25°C
Pulse Diode Forward Current	I _{SM}	—	—	-100		
Diode Forward Voltage	V _{SD}	—	-0.58	-1.1	V	V _{GS} = 0V, I _S = -5A
Reverse Recovery Time (Note 7)	t _{RR}	—	137	219	ns	I _F = -10A, di/dt = 100A/μs
Reverse Recovery Charge (Note 7)	Q _{rr}	—	221	332	nC	
Reverse Recovery Fall Time (Note 7)	t _a	—	39	—	ns	
Reverse Recovery Raise Time (Note 7)	t _b	—	98	—		

- Notes: 5. Device mounted on FR-4 substrate PC board, 2oz copper, with thermal bias to bottom layer 1inch square copper plate.
6. Short duration pulse test used to minimize self-heating effect.
7. Guaranteed by design. Not subject to product testing.
8. Package limited.

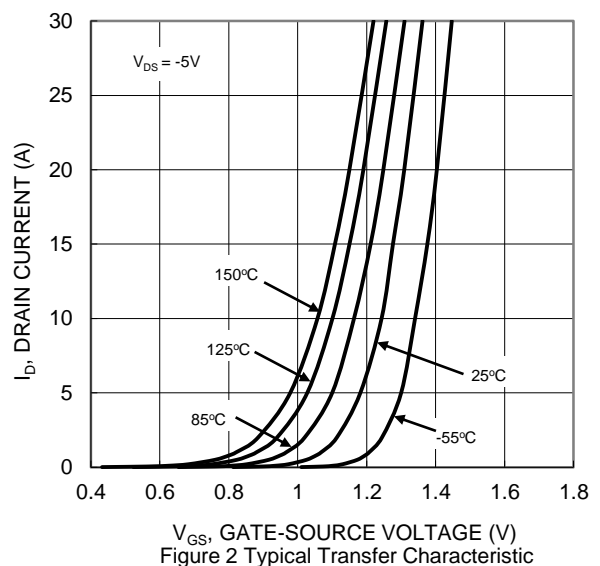
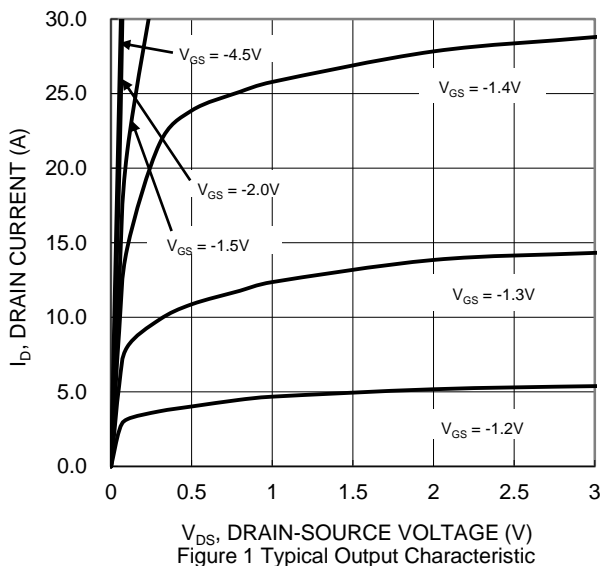

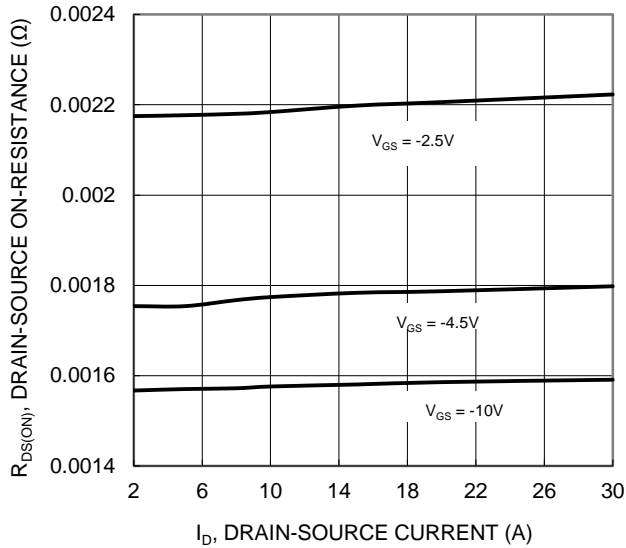

I_D , DRAIN-CURRENT (A)
Figure 3 Typical On-Resistance vs. Drain Current and Gate Voltage

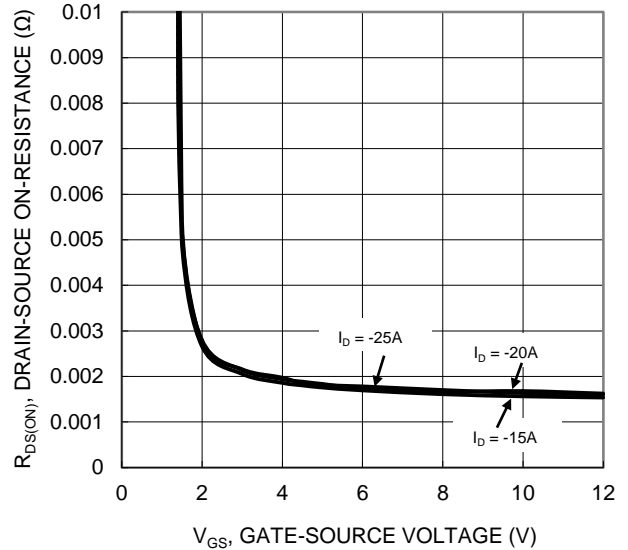

V_{GS} , GATE-SOURCE VOLTAGE (V)
Figure 4 Typical Transfer Characteristic

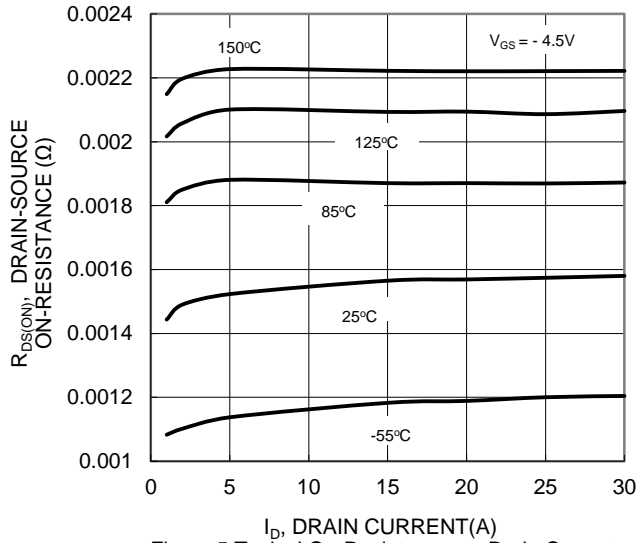

I_D , DRAIN CURRENT (A)
Figure 5 Typical On-Resistance vs. Drain Current and Temperature

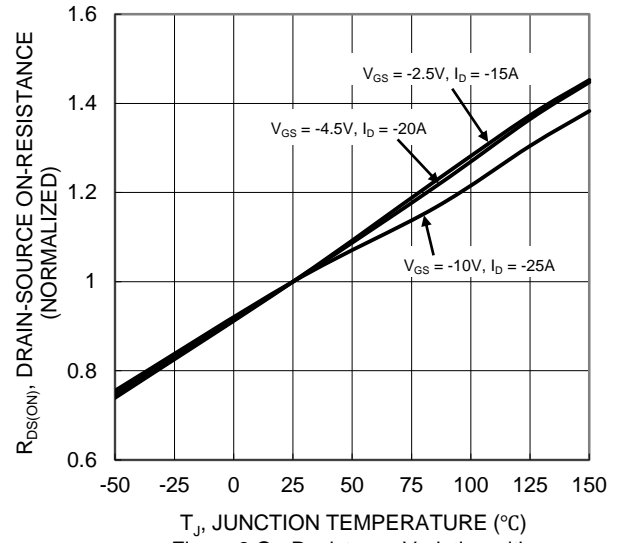

T_J , JUNCTION TEMPERATURE (°C)
Figure 6 On-Resistance Variation with Temperature

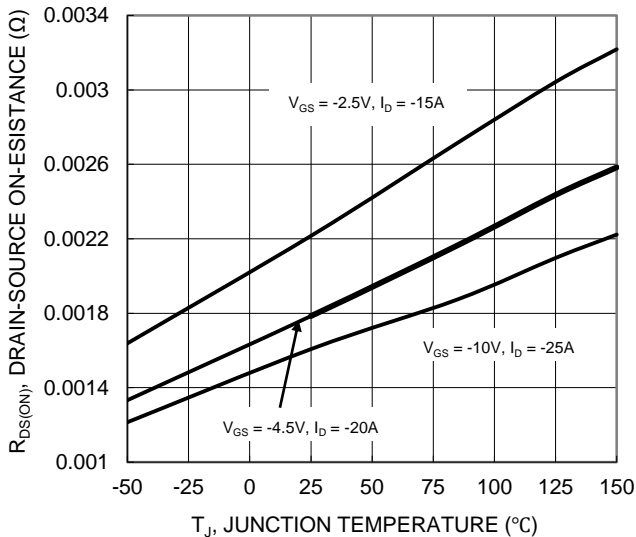

T_J , JUNCTION TEMPERATURE (°C)
Figure 7 On-Resistance Variation with Temperature

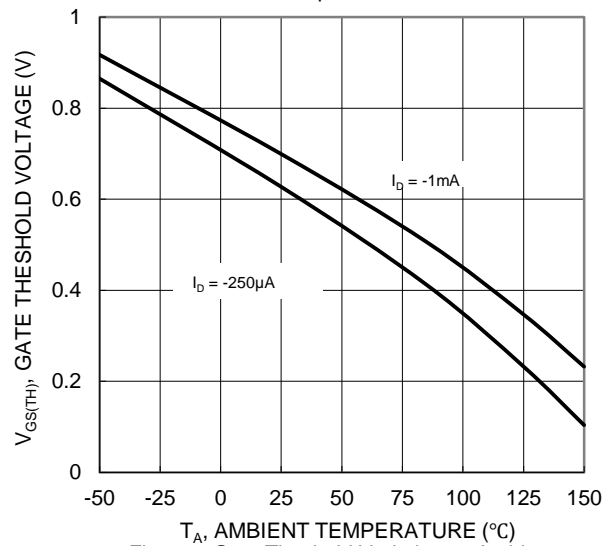

T_A , AMBIENT TEMPERATURE (°C)
Figure 8 Gate Threshold Variation vs Ambient Temperature

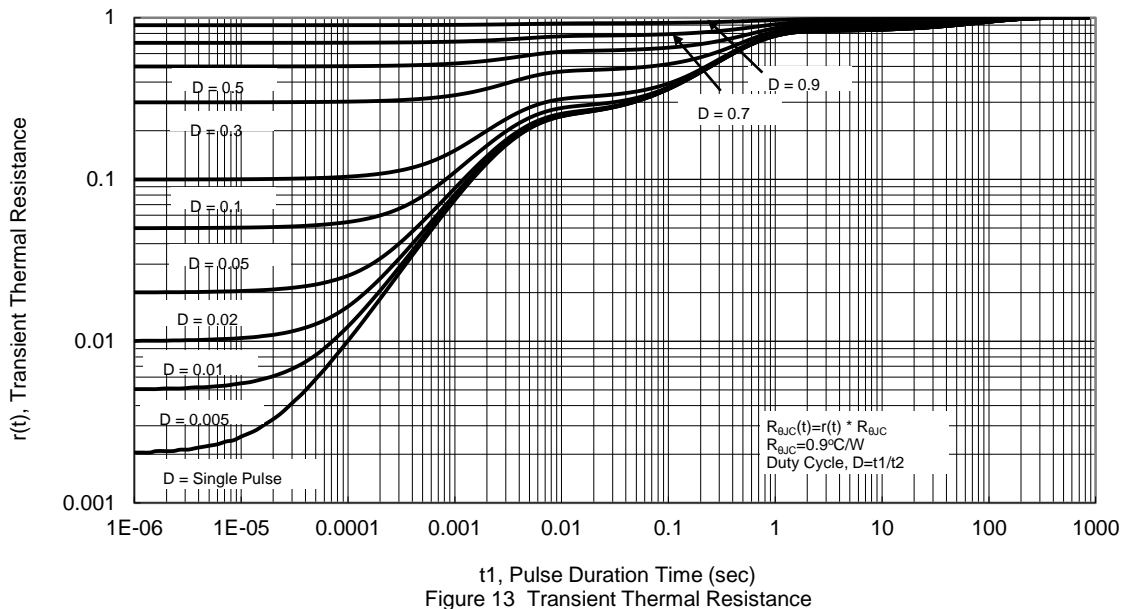
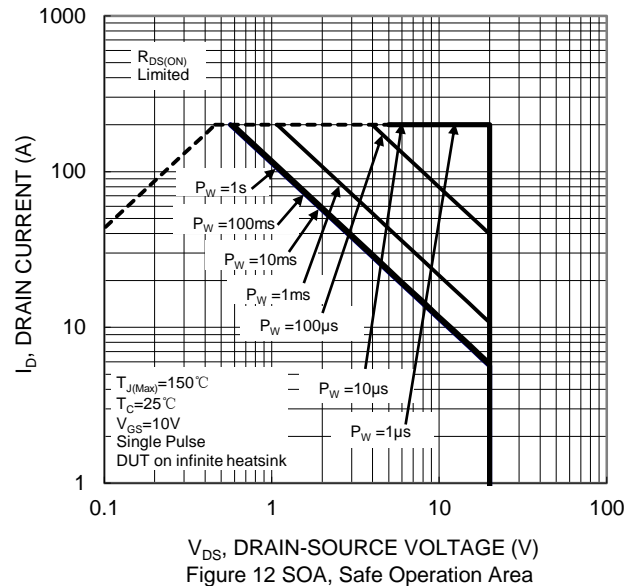
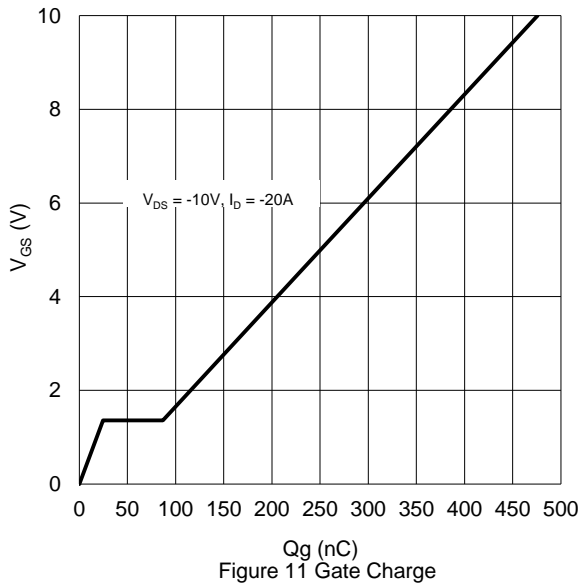
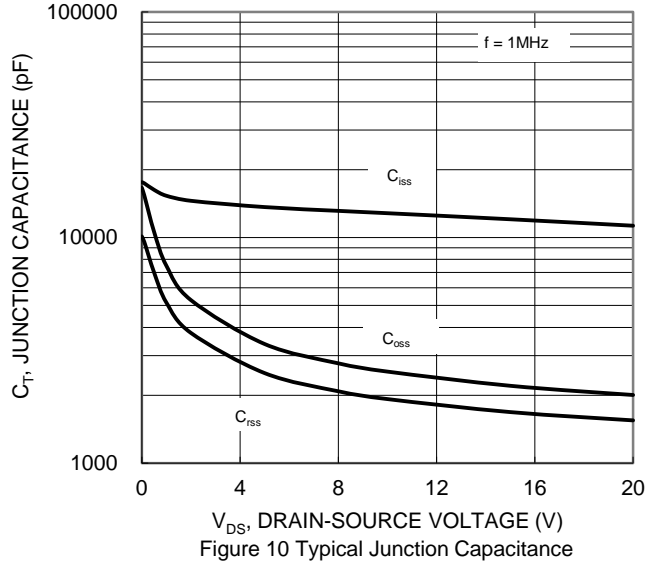
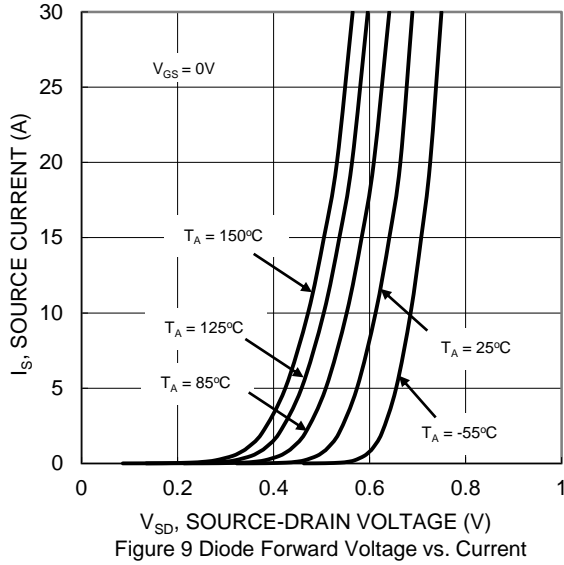

Package Outline Dimensions

Please see AP02002 at <http://www.diodes.com/datasheets/ap02002.pdf> for the latest version.

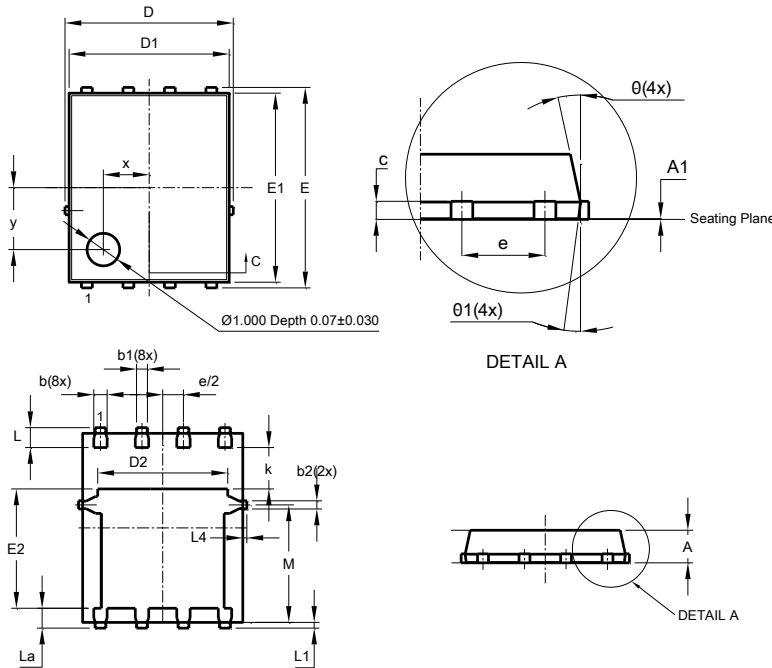

PowerDI5060-8 (Type K)			
Dim	Min	Max	Typ
A	0.90	1.10	1.00
A1	0	0.05	0.02
b	0.33	0.51	0.41
b1	0.300	0.366	0.333
b2	0.20	0.35	0.25
c	0.23	0.33	0.277
D	5.15 BSC		
D1	4.85	4.95	4.90
D2	-	-	3.98
E	6.15 BSC		
E1	5.75	5.85	5.80
E2	3.56	3.76	3.66
E	1.27BSC		
k	-	-	1.27
L	0.51	0.71	0.61
La	0.51	0.71	0.61
L1	0.05	0.20	0.175
L4	-	-	0.125
M	3.50	3.71	3.605
x	-	-	1.400
y	-	-	1.900
θ	10°	12°	11°
$\theta 1$	6°	8°	7°
All Dimensions in mm			

Suggested Pad Layout

Please see AP02001 at <http://www.diodes.com/datasheets/ap02001.pdf> for the latest version.

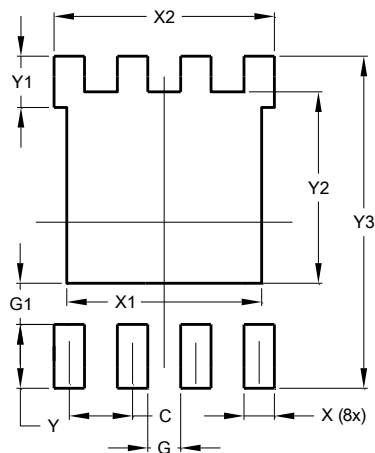

Dimensions	Value (in mm)
C	1.270
G	0.660
G1	0.820
X	0.610
X1	3.910
X2	4.420
Y	1.270
Y1	1.020
Y2	3.810
Y3	6.610

IMPORTANT NOTICE

DIODES INCORPORATED MAKES NO WARRANTY OF ANY KIND, EXPRESS OR IMPLIED, WITH REGARDS TO THIS DOCUMENT, INCLUDING, BUT NOT LIMITED TO, THE IMPLIED WARRANTIES OF MERCHANTABILITY AND FITNESS FOR A PARTICULAR PURPOSE (AND THEIR EQUIVALENTS UNDER THE LAWS OF ANY JURISDICTION).

Diodes Incorporated and its subsidiaries reserve the right to make modifications, enhancements, improvements, corrections or other changes without further notice to this document and any product described herein. Diodes Incorporated does not assume any liability arising out of the application or use of this document or any product described herein; neither does Diodes Incorporated convey any license under its patent or trademark rights, nor the rights of others. Any Customer or user of this document or products described herein in such applications shall assume all risks of such use and will agree to hold Diodes Incorporated and all the companies whose products are represented on Diodes Incorporated website, harmless against all damages.

Diodes Incorporated does not warrant or accept any liability whatsoever in respect of any products purchased through unauthorized sales channel. Should Customers purchase or use Diodes Incorporated products for any unintended or unauthorized application, Customers shall indemnify and hold Diodes Incorporated and its representatives harmless against all claims, damages, expenses, and attorney fees arising out of, directly or indirectly, any claim of personal injury or death associated with such unintended or unauthorized application.

Products described herein may be covered by one or more United States, international or foreign patents pending. Product names and markings noted herein may also be covered by one or more United States, international or foreign trademarks.

This document is written in English but may be translated into multiple languages for reference. Only the English version of this document is the final and determinative format released by Diodes Incorporated.

LIFE SUPPORT

Diodes Incorporated products are specifically not authorized for use as critical components in life support devices or systems without the express written approval of the Chief Executive Officer of Diodes Incorporated. As used herein:

A. Life support devices or systems are devices or systems which:

1. are intended to implant into the body, or
2. support or sustain life and whose failure to perform when properly used in accordance with instructions for use provided in the labeling can be reasonably expected to result in significant injury to the user.

B. A critical component is any component in a life support device or system whose failure to perform can be reasonably expected to cause the failure of the life support device or to affect its safety or effectiveness.

Customers represent that they have all necessary expertise in the safety and regulatory ramifications of their life support devices or systems, and acknowledge and agree that they are solely responsible for all legal, regulatory and safety-related requirements concerning their products and any use of Diodes Incorporated products in such safety-critical, life support devices or systems, notwithstanding any devices- or systems-related information or support that may be provided by Diodes Incorporated. Further, Customers must fully indemnify Diodes Incorporated and its representatives against any damages arising out of the use of Diodes Incorporated products in such safety-critical, life support devices or systems.

Copyright © 2015, Diodes Incorporated

www.diodes.com