

HF RoHS **Sx02xS Series**

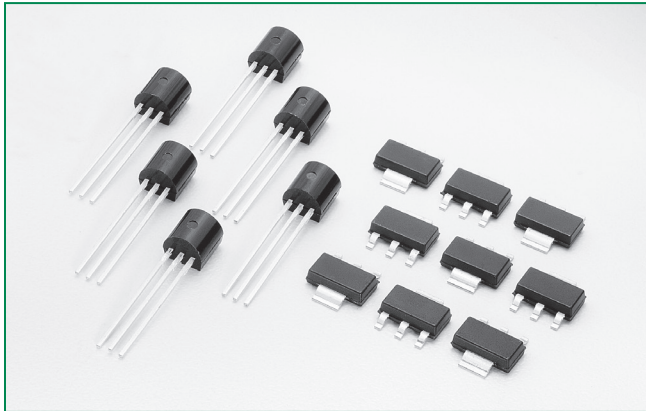

Description

New 1.5 Amp sensitive gate SCR series offers high static dv/dt with low turn off time (tq) through small die planar construction design. All SCR's junctions are glass-passivated to ensure long term reliability and parametric stability.

Features

- RoHS compliant and Halogen-Free
- Thru hole and surface mount packages
- Surge capability > 15Amps
- Blocking voltage (V_{DRM}/V_{RRM}) capability — up to 600V
- High dv/dt noise immunity
- Improved turn-off time (tq) < 35 µsec.
- Sensitive gate for direct microprocessor interface

Main Features

Symbol	Value	Unit
$I_{T(RMS)}$	1.5	A
V_{DRM}/V_{RRM}	400 to 600	V
I_{GT}	200	µA

Applications

The Sx02xS EV series is specifically designed for Gas Ignition applications that require high pulse surge current capability.

Schematic Symbol

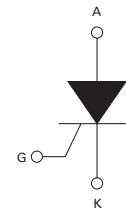

Absolute Maximum Ratings

Symbol	Parameter	Value	Unit	
$I_{T(RMS)}$	RMS on-state current (full sine wave)	TO-92 $T_c = 65^\circ\text{C}$	1.5	A
		SOT-223 $T_L = 95^\circ\text{C}$		
$I_{T(AV)}$	Average on-state current	TO-92 $T_c = 65^\circ\text{C}$	0.95	A
		SOT-223 $T_c = 95^\circ\text{C}$		
I_{TSM}	Non repetitive surge peak on-state current (Single cycle, T_J initial = 25°C)	TO-92 $F = 50$ Hz	12.5	A
		SOT-223 $F = 60$ Hz	15.0	
I^2t	I^2t Value for fusing	$t_p = 10$ ms $F = 50$ Hz	0.78	A ² s
		$t_p = 8.3$ ms $F = 60$ Hz	0.93	
di/dt	Critical rate of rise of on-state current $I_G = 10\text{mA}$	TO-92 $T_J = 125^\circ\text{C}$ SOT-223	50	A/µs
I_{GM}	Peak gate current	$t_p = 10$ µs $T_J = 125^\circ\text{C}$	1.0	A
$P_{G(AV)}$	Average gate power dissipation	$T_J = 125^\circ\text{C}$	0.1	W
T_{stg}	Storage junction temperature range		-40 to 150	°C
T_J	Operating junction temperature range		-40 to 125	°C

Electrical Characteristics ($T_J = 25^\circ\text{C}$, unless otherwise specified)

Symbol	Description	Test Conditions	Sx02xS		Unit
			Min	Max	
I_{GT}	DC Gate Trigger Current	$V_D = 12\text{V}$ $R_L = 60\ \Omega$	15	200	μA
V_{GT}	DC Gate Trigger Voltage		—	0.8	V
V_{GRM}	Peak Reverse Gate Voltage	$I_{RG} = 10\ \mu\text{A}$	5	—	V
I_H	Holding Current	$R_{GK} = 1\ \text{k}\Omega$	—	5	mA
(dv/dt)s	Critical Rate-of-Rise of Off-State Voltage	$T_J = 125^\circ\text{C}$ $V_D = V_{DRM} / V_{RRM}$ Exponential Waveform $R_{GK} = 1\ \text{k}\Omega$	25	—	V/ μs
t_q	Turn-Off Time	$T_J = 125^\circ\text{C} @ 600\ \text{V}$ $R_{GK} = 1\ \text{k}\Omega$	—	35	μs
t_{gt}	Turn-On Time	$I_G = 10\ \text{mA}$ PW = 15 μsec $I_T = 3.0\ \text{A}$ (pk)	—	3	μs

Static Characteristics ($T_J = 25^\circ\text{C}$, unless otherwise specified)

Symbol	Description	Test Conditions	Value		Unit
			Min	Max	
V_{TM}	Peak On-State Voltage	$I_{TM} = 3.0\ \text{A}$ (pk)	—	1.70	V
I_{DRM}	Off-State Current, Peak Repetitive	$T_J = 25^\circ\text{C} @ V_D = V_{DRM}$ $R_{GK} = 1\ \text{k}\Omega$	—	5	μA
		$T_J = 125^\circ\text{C} @ V_D = V_{DRM}$ $R_{GK} = 1\ \text{k}\Omega$	—	500	μA

Thermal Resistances

Symbol	Description	Test Conditions	Value	Unit	
$R_{th(j-c)}$	Junction to case (AC)	$I_T = 1.5\ \text{A}_{(RMS)}$ ¹	TO-92	50	$^\circ\text{C}/\text{W}$
			SOT-223	25	
$R_{th(j-a)}$	Junction to ambient	$I_T = 1.5\ \text{A}_{(RMS)}$ ¹	TO-92	160	$^\circ\text{C}/\text{W}$
			SOT-223	60	

¹ 60Hz AC resistive load condition, 100% conduction.

Figure 1: Normalized DC Gate Trigger Current vs. Junction Temperature

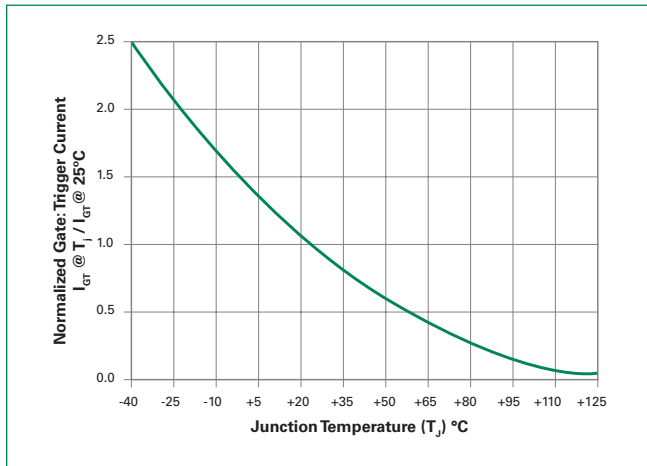

Figure 2: Normalized DC Holding Current vs. Junction Temperature

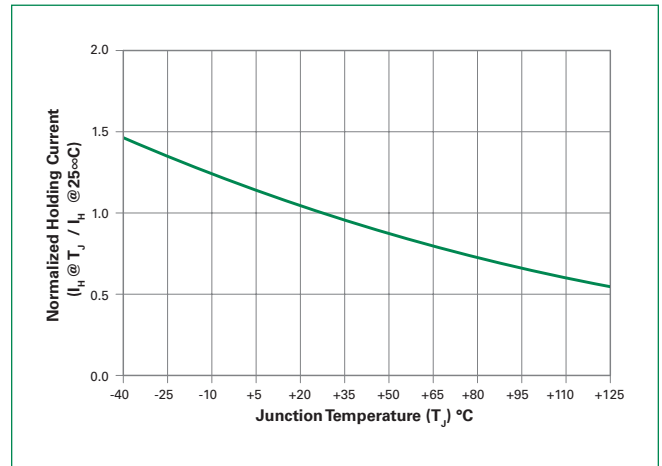

Figure 3: Normalized DC Gate Trigger Voltage vs. Junction Temperature

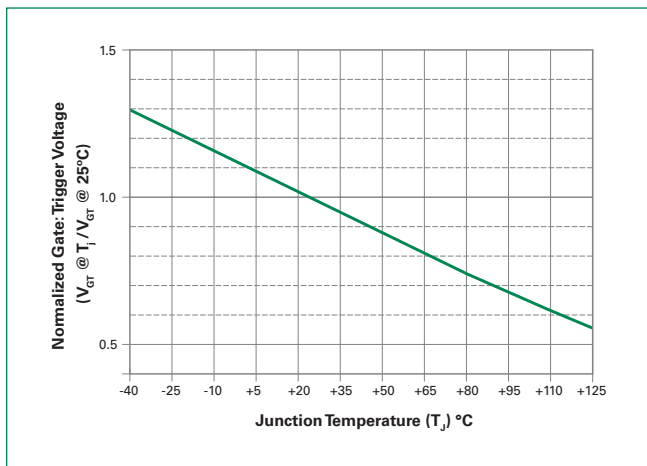

Figure 4: Power Dissipation (Typical) vs. RMS On-State Current

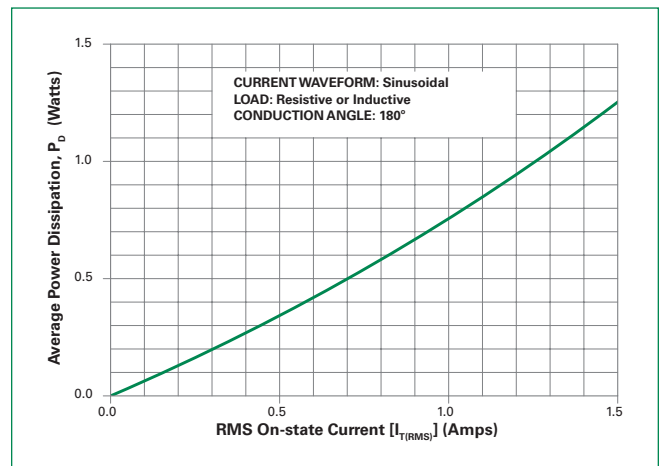

Figure 5: Maximum Allowable Case Temperature vs. On-State Current

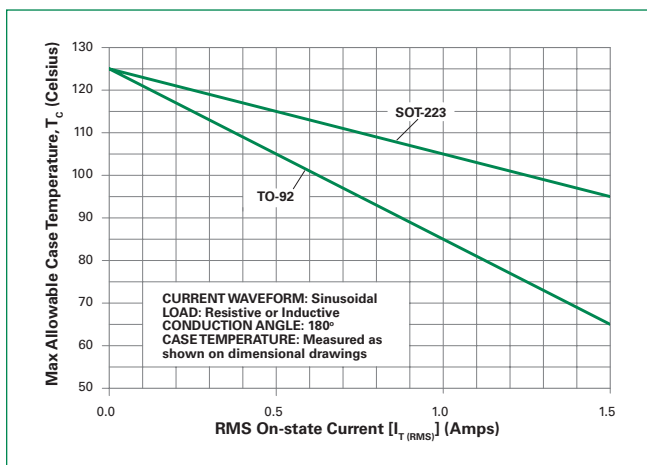
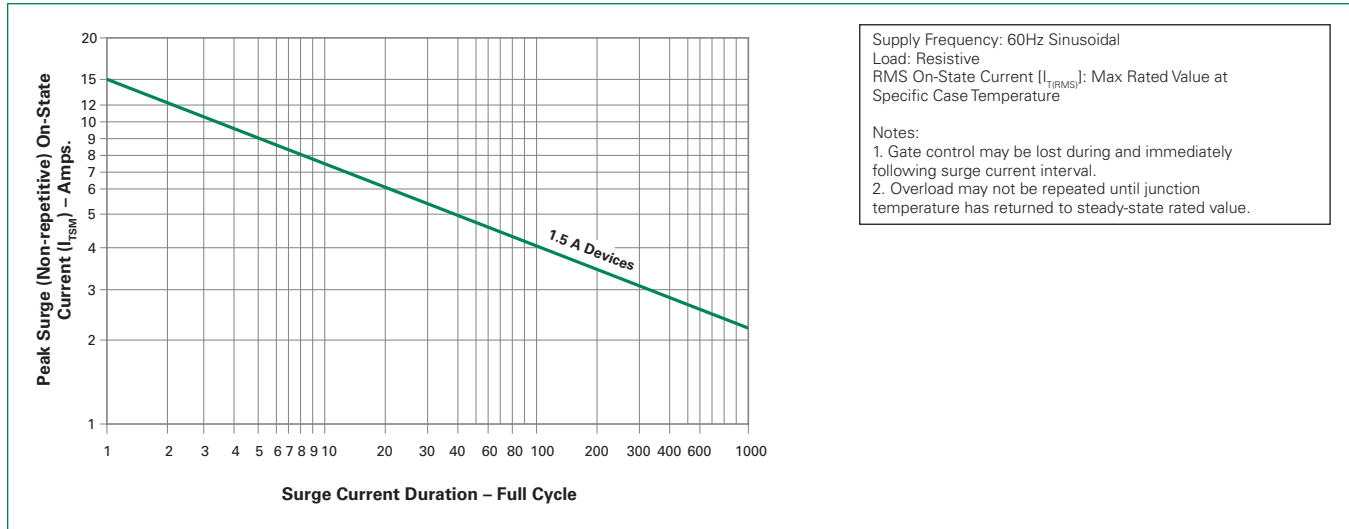
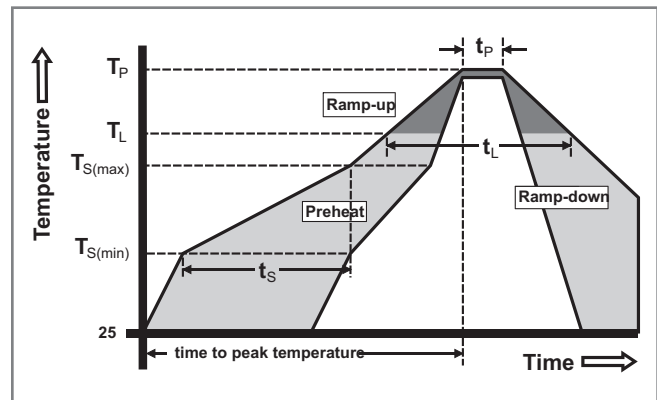

Figure 6: Surge Peak On-State Current vs. Number of Cycles



Soldering Parameters

Reflow Condition		Pb – Free assembly
Pre Heat	- Temperature Min ($T_{s(min)}$)	150°C
	- Temperature Max ($T_{s(max)}$)	200°C
	- Time (min to max) (t_s)	60 – 180 secs
Average ramp up rate (Liquidus Temp) (T_L) to peak		5°C/second max
$T_{s(max)}$ to T_L - Ramp-up Rate		5°C/second max
Reflow	- Temperature (T_L) (Liquidus)	217°C
	- Time (min to max) (t_s)	60 – 150 seconds
Peak Temperature (T_p)		260 ^{+0/-5} °C
Time within 5°C of actual peak Temperature (t_p)		20 – 40 seconds
Ramp-down Rate		5°C/second max
Time 25°C to peak Temperature (T_p)		8 minutes Max.
Do not exceed		280°C



Physical Specifications

Terminal Finish	100% Matte Tin-plated.
Body Material	UL recognized epoxy meeting flammability classification 94V-0.
Lead Material	Copper Alloy

Design Considerations

Careful selection of the correct device for the application's operating parameters and environment will go a long way toward extending the operating life of the Thyristor. Good design practice should limit the maximum continuous current through the main terminals to 75% of the device rating. Other ways to ensure long life for a power discrete semiconductor are proper heat sinking and selection of voltage ratings for worst case conditions. Overheating, overvoltage (including dv/dt), and surge currents are the main killers of semiconductors. Correct mounting, soldering, and forming of the leads also help protect against component damage.

Environmental Specifications

Test	Specifications and Conditions
AC Blocking	MIL-STD-750, M-1040, Cond A Applied Peak AC voltage @ 125°C for 1008 hours
Temperature Cycling	MIL-STD-750, M-1051, 100 cycles; -40°C to +150°C; 15-min dwell-time
Temperature/Humidity	EIA / JEDEC, JESD22-A101 1008 hours; 320V - DC: 85°C; 85% rel humidity
High Temp Storage	MIL-STD-750, M-1031, 1008 hours; 150°C
Low-Temp Storage	1008 hours; -40°C
Thermal Shock	MIL-STD-750, M-1056 10 cycles; 0°C to 100°C; 5-min dwell-time at each temperature; 10 sec (max) transfer time between temperature
Autoclave	EIA / JEDEC, JESD22-A102 168 hours (121°C at 2 ATMs) and 100% R/H
Resistance to Solder Heat	MIL-STD-750 Method 2031
Solderability	ANSI/J-STD-002, category 3, Test A
Lead Bend	MIL-STD-750, M-2036 Cond E

Dimensions – TO-92 (E Package)

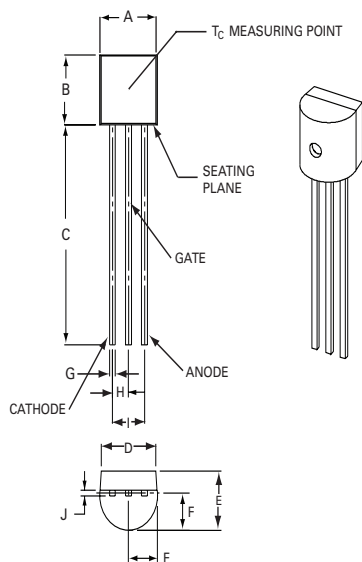

Dimensions	Inches		Millimeters	
	Min	Max	Min	Max
A	0.175	0.205	4.450	5.200
B	0.170	0.210	4.320	5.330
C	0.500		12.70	
D	0.135		3.430	
E	0.125	0.165	3.180	4.190
F	0.080	0.105	2.040	2.660
G	0.016	0.021	0.407	0.533
H	0.045	0.055	1.150	1.390
I	0.095	0.105	2.420	2.660
J	0.015	0.020	0.380	0.500

Dimensions – SOT-223

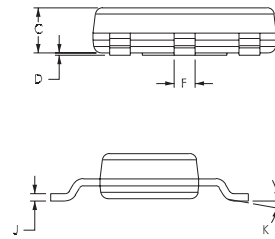
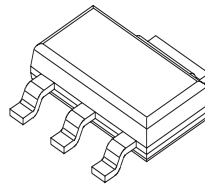
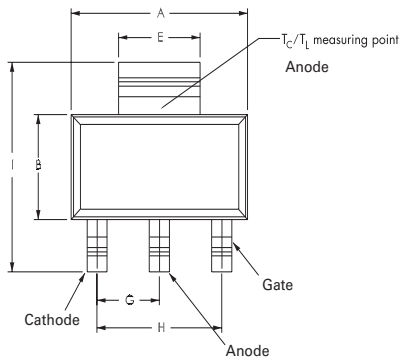

Pad Layout for SOT-223

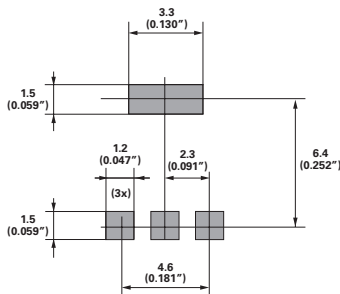

Dimensions in Millimeters (Inches)

Dimensions	Inches			Millimeters		
	Min	Typ	Max	Min	Typ	Max
A	0.248	0.256	0.264	6.30	6.50	6.70
B	0.130	0.138	0.146	3.30	3.50	3.70
C	—	—	0.071	—	—	1.80
D	0.001	—	0.004	0.02	—	0.10
E	0.114	0.118	0.124	2.90	3.00	3.15
F	0.024	0.027	0.034	0.60	0.70	0.85
G	—	0.090	—	—	2.30	—
H	—	0.181	—	—	4.60	—
I	0.264	0.276	0.287	6.70	7.00	7.30
J	0.009	0.010	0.014	0.24	0.26	0.35
K	10° MAX					

Product Selector

Part Number	Voltage		Gate Sensitivity	Package
	400V	600V		
S402ES	X	—	200µA	TO-92
S602ES	—	X	200µA	TO-92
S402TS	X	—	200µA	SOT-223
S602TS	—	X	200µA	SOT-223

Packing Options

Part Number	Marking	Weight	Packing Mode	Base Quantity
Sx02ES	Sx02ES	0.170 g	Bulk	2500
Sx02ESAP	Sx02ES	0.170 g	Ammo Pack	2000
Sx02ESRP	Sx02ES	0.170 g	Tape & Reel	2000
Sx02TSRP	Sx02TS	0.120 g	Tape & Reel	1000

Note: x = voltage

TO-92 (3-lead) Reel Pack (RP) Radial Leaded Specifications

Meets all EIA-468-C Standards

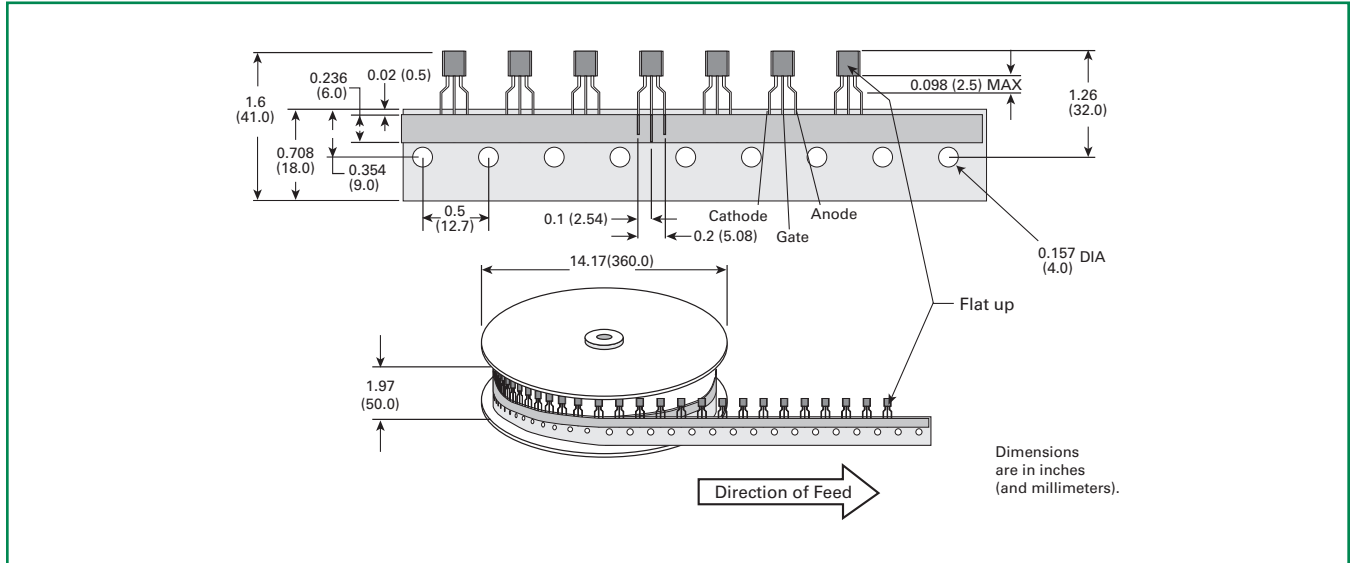

TO-92 (3-lead) Ammo Pack (AP) Radial Leaded Specifications

Meets all EIA-468-C Standards

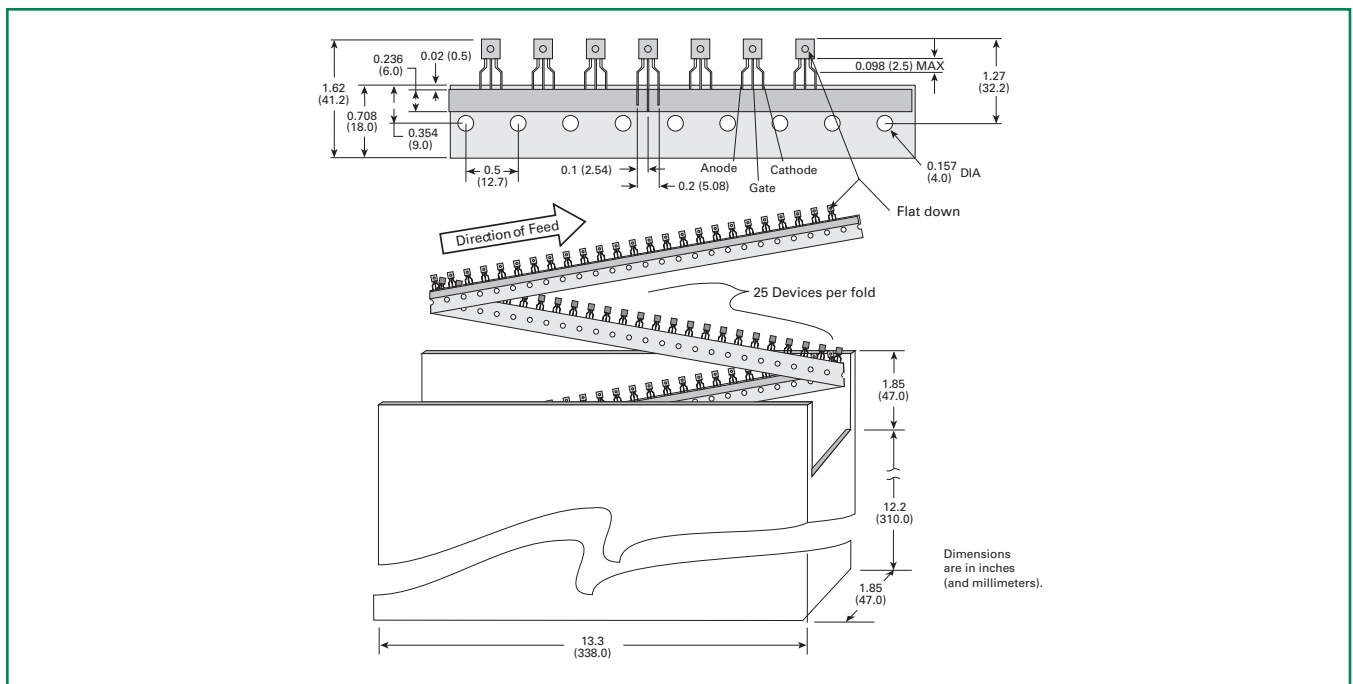

Mouser Electronics

Authorized Distributor

Click to View Pricing, Inventory, Delivery & Lifecycle Information:

Littelfuse:

[S4X8ESRP](#) [S6X8ESRP](#) [S4X8ESAP](#) [S4X8ES](#) [S6X8ES](#) [S602ES](#) [S402ESRP](#) [S602ESRP](#) [S402ESAP](#) [S602ESAP](#)
[S6X8TSRP](#) [S602TSRP](#) [S402TSRP](#) [S402ES](#) [S6X8BSRP](#) [S6X8ES1RP](#) [S6X8ES2RP](#) [S6X8TS1RP](#) [S6X8TS2RP](#)
[S8X8ESRP](#) [S8X8ES1RP](#) [S8X8ES2RP](#) [S8X8TSRP](#) [S8X8TS1RP](#) [S8X8TS2RP](#)