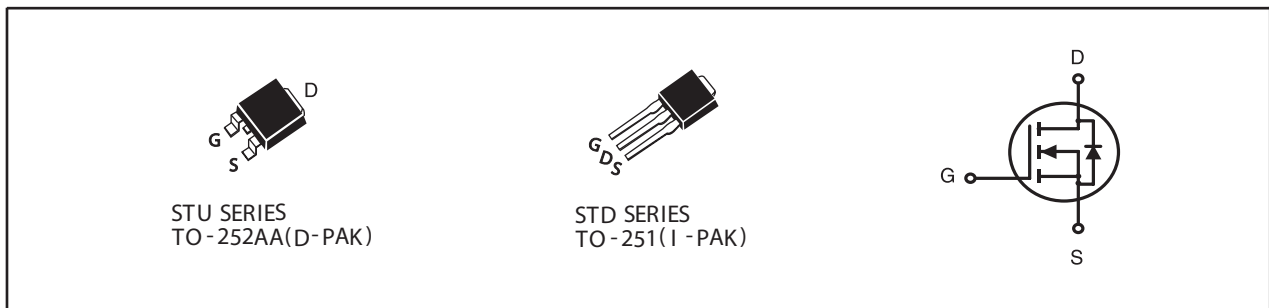

**N-Channel Logic Level Enhancement Mode Field Effect Transistor****PRODUCT SUMMARY**

VDSS	ID	RDS(ON) (mΩ) Max
40V	38A	16.5 @ VGS=10V
		28 @ VGS=4.5V

FEATURES

- Super high dense cell design for low RDS(ON).
- Rugged and reliable.
- TO-252 and TO-251 Package.
- Pb Free and Halogan Free.

**ABSOLUTE MAXIMUM RATINGS (TA=25°C unless otherwise noted)**

Symbol	Parameter	Limit	Units
V _{DS}	Drain-Source Voltage	40	V
V _{GS}	Gate-Source Voltage	±20	V
I _D	Drain Current-Continuous ^a	T _C =25°C	38
		T _C =70°C	30
I _{DM}	-Pulsed ^b	111	A
E _{AS}	Single Pulse Avalanche Energy ^d	64	mJ
P _D	Maximum Power Dissipation ^a	T _C =25°C	42
		T _C =70°C	27
T _J , T _{STG}	Operating Junction and Storage Temperature Range	-55 to 150	°C

THERMAL CHARACTERISTICS

R _{θJC}	Thermal Resistance, Junction-to-Case ^a	3	°C/W
R _{θJA}	Thermal Resistance, Junction-to-Ambient ^a	50	°C/W

STU/D446S

Ver 2.0

ELECTRICAL CHARACTERISTICS (T_A=25°C unless otherwise noted)

Symbol	Parameter	Conditions	Min	Typ	Max	Units
OFF CHARACTERISTICS						
BV _{DSS}	Drain-Source Breakdown Voltage	V _{GS} =0V , I _D =250uA	40			V
I _{DSS}	Zero Gate Voltage Drain Current	V _{DS} =32V , V _{GS} =0V			1	uA
I _{GSS}	Gate-Body Leakage Current	V _{GS} = ±20V , V _{DS} =0V			±100	nA
ON CHARACTERISTICS						
V _{GS(th)}	Gate Threshold Voltage	V _{DS} =V _{GS} , I _D =250uA	1.7	2.0	3	V
R _{DS(ON)}	Drain-Source On-State Resistance	V _{GS} =10V , I _D =19A		13	16.5	m ohm
		V _{GS} =4.5V , I _D =16A		20	28	m ohm
g _{FS}	Forward Transconductance	V _{DS} =5V , I _D =19A		43		S
DYNAMIC CHARACTERISTICS ^c						
C _{ISS}	Input Capacitance	V _{DS} =20V, V _{GS} =0V f=1.0MHz		755		pF
C _{OSS}	Output Capacitance			121		pF
C _{RSS}	Reverse Transfer Capacitance			102		pF
SWITCHING CHARACTERISTICS ^c						
t _{D(ON)}	Turn-On Delay Time	V _{DD} =20V I _D =1A V _{GS} =10V R _{GEN} = 6 ohm		16		ns
t _r	Rise Time			29		ns
t _{D(OFF)}	Turn-Off Delay Time			42		ns
t _f	Fall Time			10		ns
Q _g	Total Gate Charge	V _{DS} =20V, I _D =19A, V _{GS} =10V		16.5		nC
		V _{DS} =20V, I _D =19A, V _{GS} =4.5V		8.7		nC
Q _{gs}	Gate-Source Charge	V _{DS} =20V, I _D =19A, V _{GS} =10V		2.1		nC
Q _{gd}	Gate-Drain Charge			5		nC
DRAIN-SOURCE DIODE CHARACTERISTICS AND MAXIMUM RATINGS						
I _S	Maximum Continuous Drain-Source Diode Forward Current				2	A
V _{SD}	Diode Forward Voltage ^b	V _{GS} =0V, I _S =4A		0.79	1.3	V

Notes

- Surface Mounted on FR4 Board, t ≤ 10sec.
- Pulse Test: Pulse Width ≤ 300us, Duty Cycle ≤ 2%.
- Guaranteed by design, not subject to production testing.
- Starting T_J=25°C, L=0.5mH, V_{DD} = 20V. (See Figure13)

Jul, 14, 2011

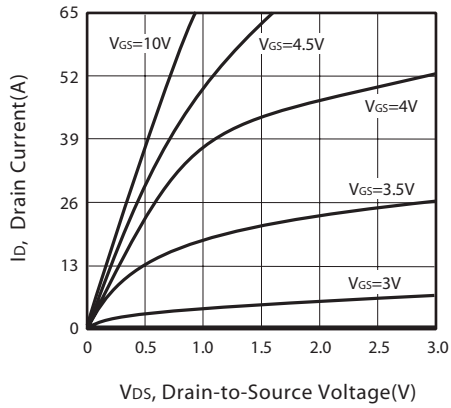

Figure 1. Output Characteristics

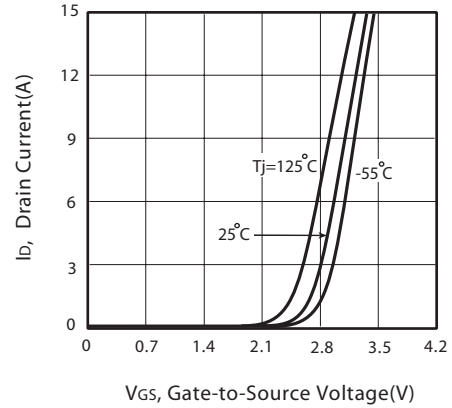

Figure 2. Transfer Characteristics

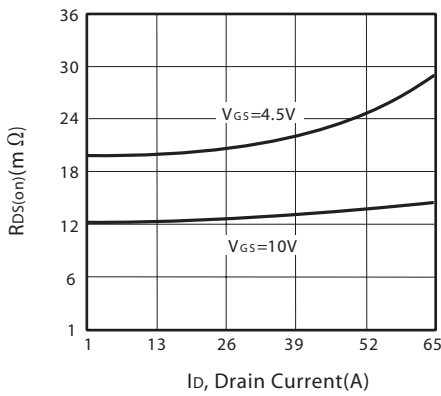

Figure 3. On-Resistance vs. Drain Current and Gate Voltage

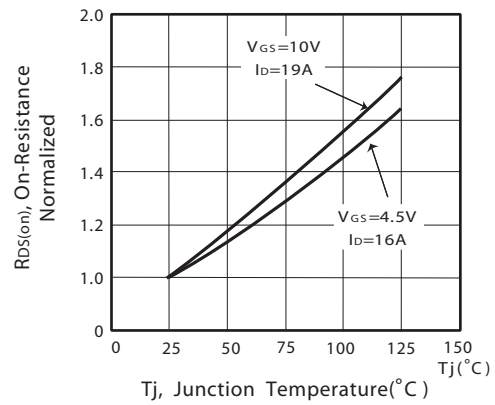

Figure 4. On-Resistance Variation with Drain Current and Temperature

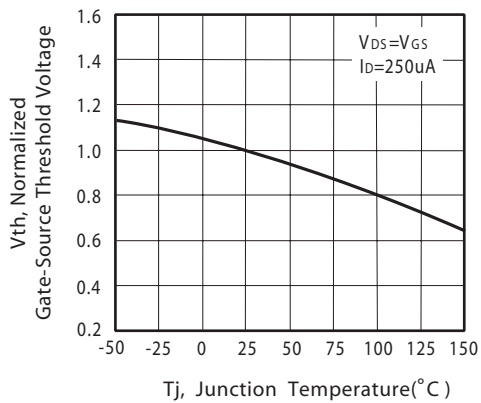

Figure 5. Gate Threshold Variation with Temperature

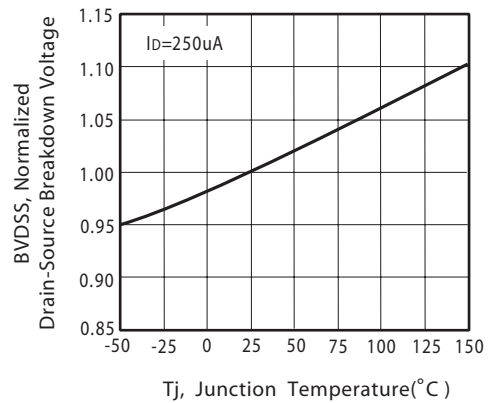

Figure 6. Breakdown Voltage Variation with Temperature

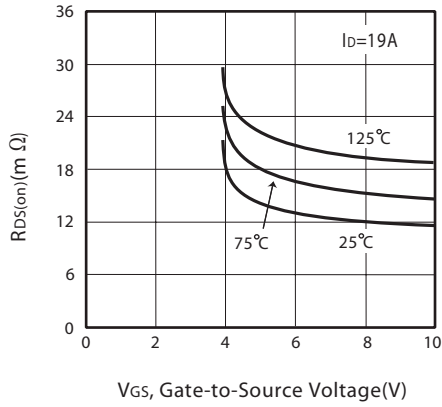

Figure 7. On-Resistance vs. Gate-Source Voltage

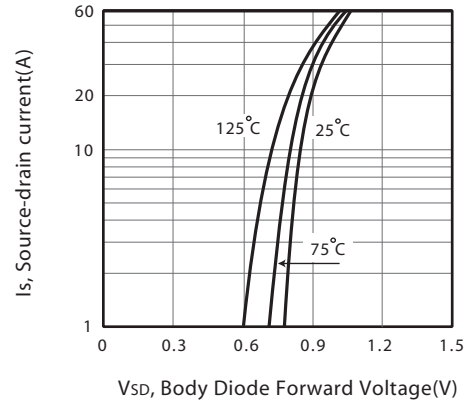

Figure 8. Body Diode Forward Voltage Variation with Source Current

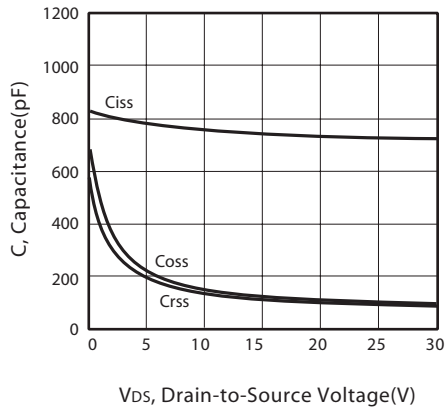

Figure 9. Capacitance

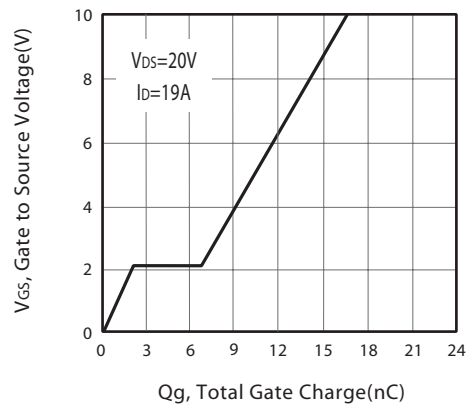

Figure 10. Gate Charge

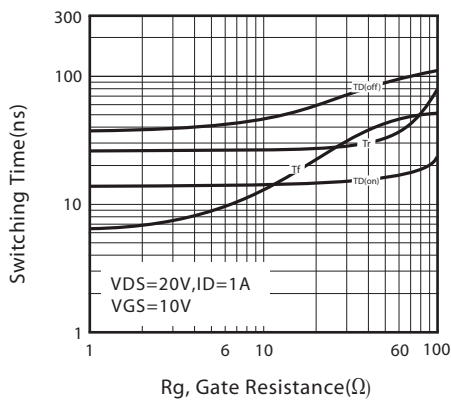

Figure 11. switching characteristics

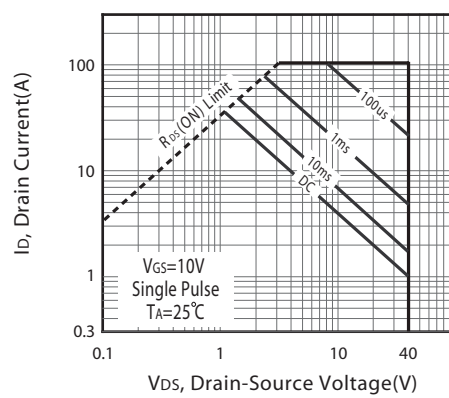
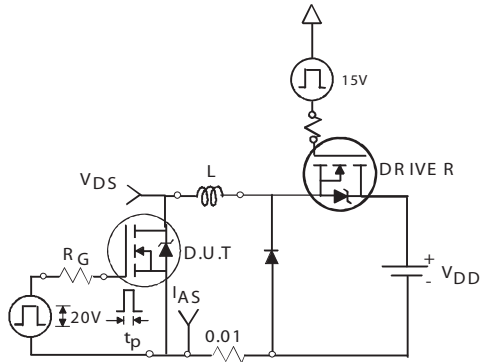
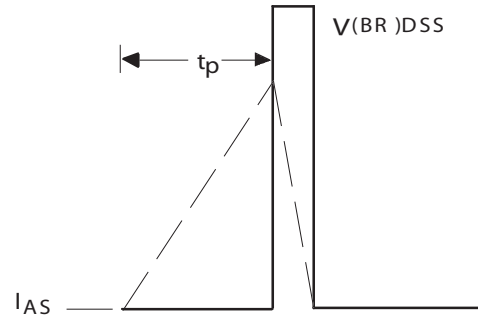

Figure 12. Maximum Safe Operating Area



Unclamped Inductive Test Circuit

Figure 13a.



Unclamped Inductive Waveforms

Figure 13b.

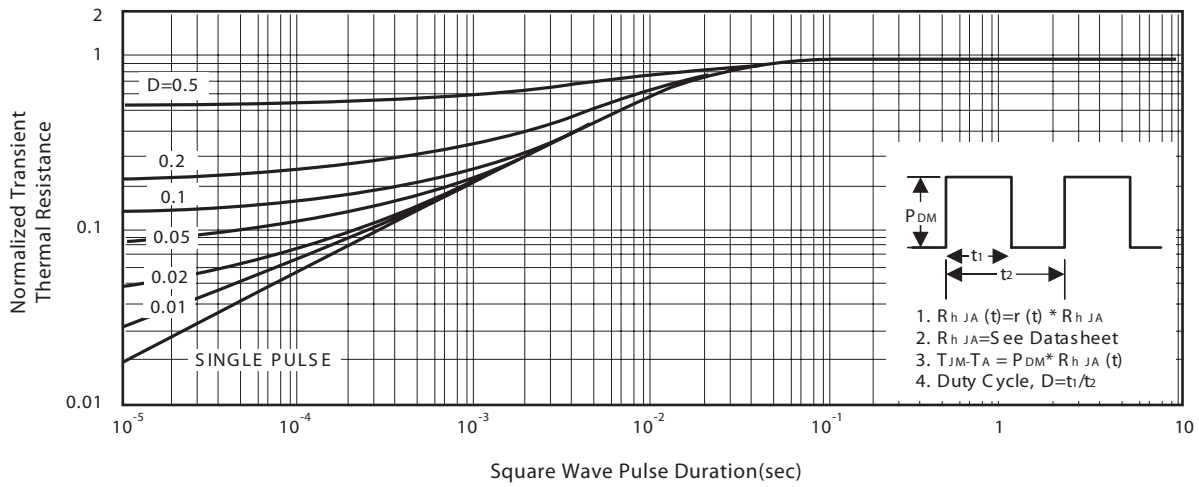
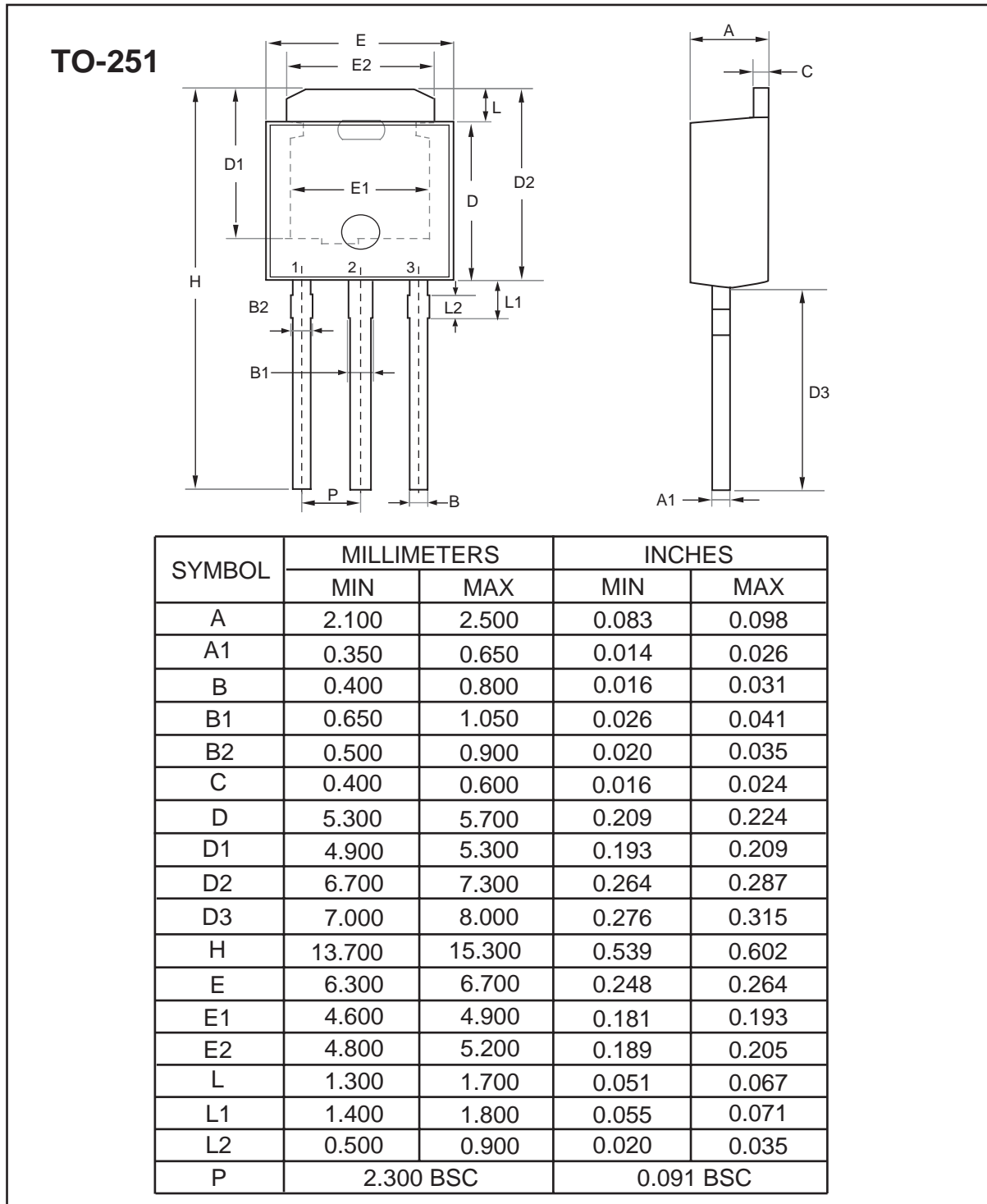

Figure 14. Normalized Thermal Transient Impedance Curve

PACKAGE OUTLINE DIMENSIONS



STU/D446S

Ver 2.0

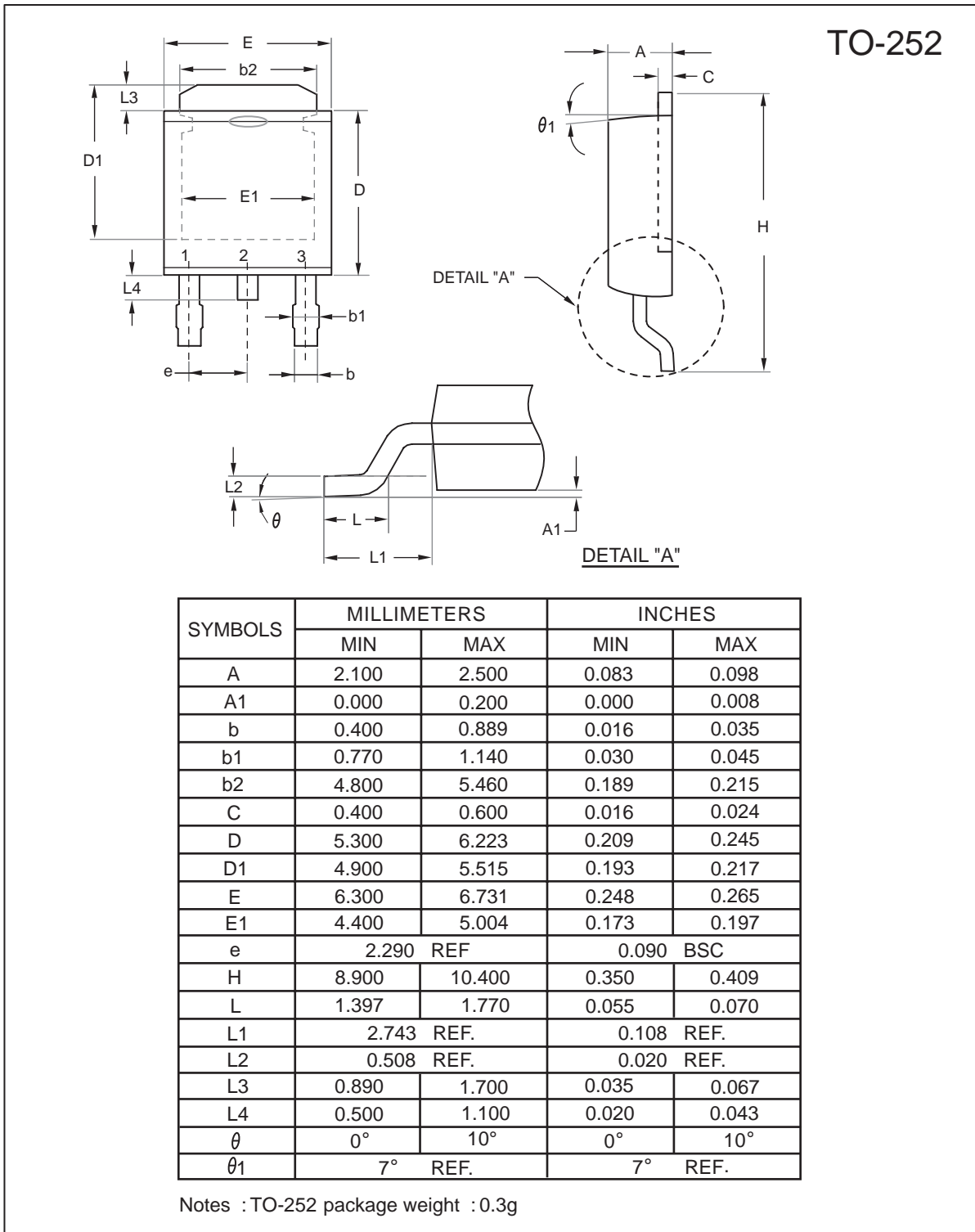

Jul,14,2011

TO-251 Tube/TO-252 Tape and Reel Data

TO-251 Tube

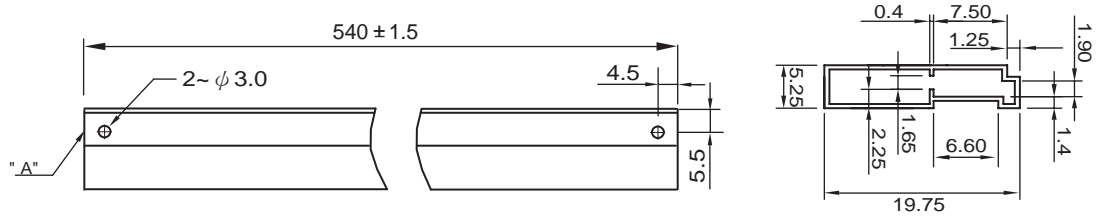

TO-252 Carrier Tape

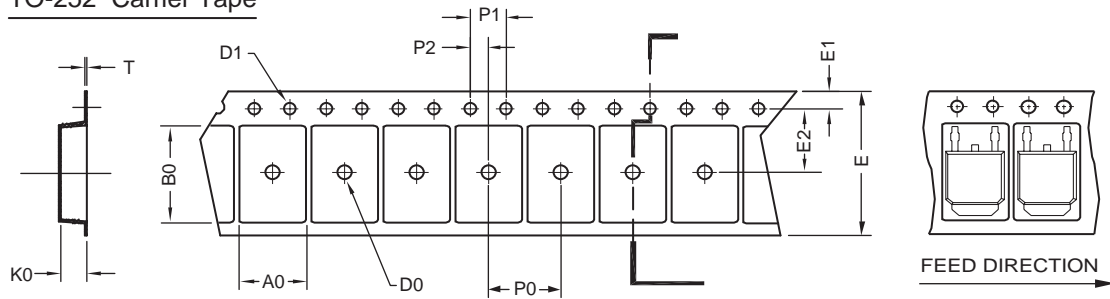

UNIT:mm

PACKAGE	A0	B0	K0	D0	D1	E	E1	E2	P0	P1	P2	T
TO-252 (16 mm)	6.96 ±0.1	10.49 ±0.1	2.79 ±0.1	φ 2	φ 1.5 +0.1 - 0	16.0 ±0.3	1.75 ±0.1	7.5 ±0.15	8.0 ±0.1	4.0 ±0.1	2.0 ±0.15	0.3 ±0.05

TO-252 Reel

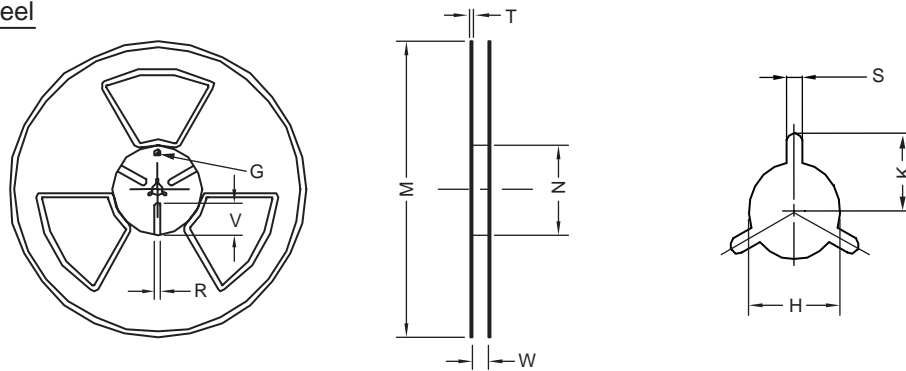

UNIT:mm

TAPE SIZE	REEL SIZE	M	N	W	T	H	K	S	G	R	V
16 mm	φ 330	φ 330 ± 0.5	φ 97 ± 1.0	17.0 + 1.5 - 0	2.2	φ 13.0 + 0.5 - 0.2	10.6	2.0 ±0.5	---	---	---