

Power Schottky rectifier

Features

- High current capability
- Avalanche rated
- Low forward voltage drop
- High frequency operation

Description

The STPS30SM60S is a single Schottky diode, suited for high frequency switch mode power supply.

Packaged in TO-220AB, I²PAK and D²PAK, this device is intended to be used in notebook, game station and desktop adapters, providing in these applications a good efficiency at both low and high load.

Table 1. Device summary

Symbol	Value
$I_{F(AV)}$	30 A
V_{RRM}	60 V
V_F (typ)	0.405 V
T_j (max)	150 °C

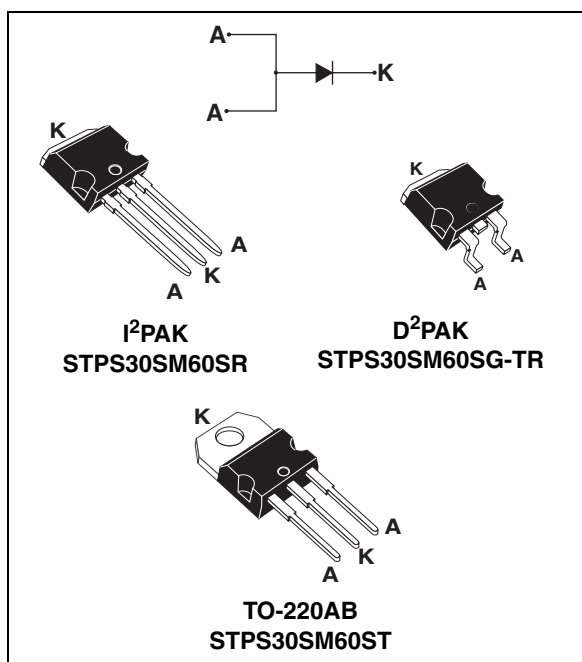
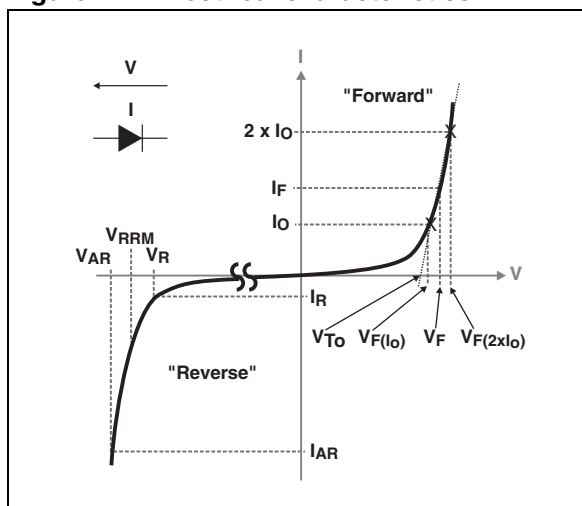

Figure 1. Electrical characteristics (a)



- a. V_{ARM} and I_{ARM} must respect the reverse safe operating area defined in [Figure 12](#). V_{AR} and I_{AR} are pulse measurements ($t_p < 1 \mu s$). V_R , I_R , V_{RRM} and V_F are static characteristics

1 Characteristics

Table 2. Absolute ratings (limiting values with terminals 1 and 3 short circuited at 25 °C, unless otherwise specified)

Symbol	Parameter		Value	Unit
V_{RRM}	Repetitive peak reverse voltage		60	V
$I_{F(RMS)}$	Forward rms current		90	A
$I_{F(AV)}$	Average forward current, $\delta = 0.5$	$T_c = 125\text{ °C}$ Per package	30	A
I_{FSM}	Surge non repetitive forward current	$t_p = 10\text{ ms sine-wave}$	600	A
$P_{ARM}^{(1)}$	Repetitive peak avalanche power	$T_j = 25\text{ °C}, t_p = 1\text{ }\mu\text{s}$	28000	W
$V_{ARM}^{(2)}$	Maximum repetitive peak avalanche voltage	$t_p < 1\text{ }\mu\text{s}, T_j < 150\text{ °C}, I_{AR} < 105\text{ A}$	80	V
$V_{ASM}^{(2)}$	Maximum single-pulse peak avalanche voltage	$t_p < 1\text{ }\mu\text{s}, T_j < 150\text{ °C}, I_{AR} < 105\text{ A}$	80	V
T_{stg}	Storage temperature range		-65 to +175	°C
T_j	Maximum operating junction temperature ⁽³⁾		150	°C

1. For temperature or pulse time duration deratings, please refer to [Figure 4](#) and [5](#). More details regarding the avalanche energy measurements and diode validation in the avalanche are provided in the application notes AN1768 and AN2025.
2. See [Figure 12](#)
3. $\frac{dP_{tot}}{dT_j} < \frac{1}{R_{th(j-a)}}$ condition to avoid thermal runaway for a diode on its own heatsink

Table 3. Thermal resistance

Symbol	Parameter	Value	Unit
$R_{th(j-c)}$	Junction to case	1.0	°C/W

Table 4. Static electrical characteristics (terminals 1 and 3 short circuited)

Symbol	Parameter	Test conditions	Min.	Typ.	Max.	Unit
$I_R^{(1)}$	Reverse leakage current	$T_j = 25\text{ °C}$	-	30	135	μA
		$T_j = 125\text{ °C}$		20	80	mA
$V_F^{(2)}$	Forward voltage drop	$T_j = 25\text{ °C}$	-	0.490	0.530	V
		$T_j = 125\text{ °C}$		0.405	0.450	
		$T_j = 25\text{ °C}$	-	0.560	0.615	
		$T_j = 125\text{ °C}$		0.500	0.570	

1. Pulse test: $t_p = 5\text{ ms}, \delta < 2\%$
2. Pulse test: $t_p = 380\text{ }\mu\text{s}, \delta < 2\%$

To evaluate the conduction losses use the following equation:

$$P = 0.440 \times I_{F(AV)} + 0.0043 \times I_{F(RMS)}^2$$

Figure 2. Average forward power dissipation versus average forward current

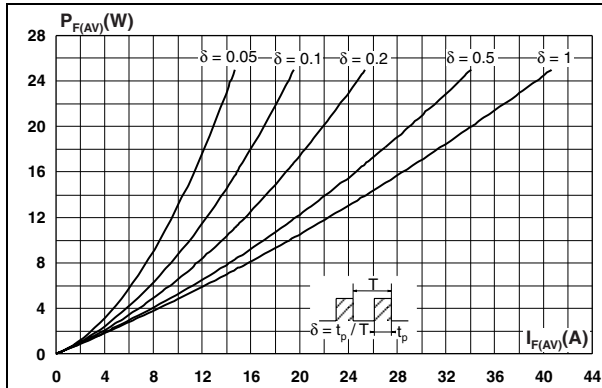

Figure 3. Average forward current versus ambient temperature ($\delta = 0.5$)

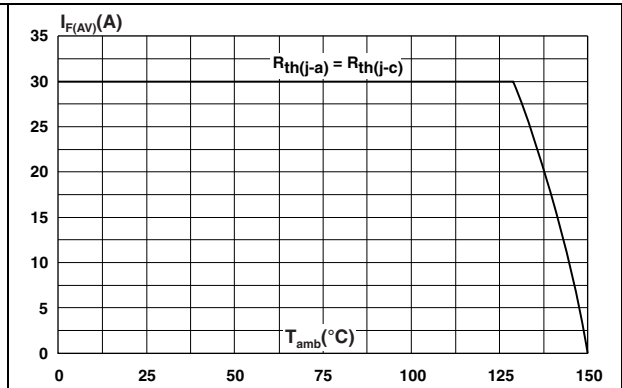

Figure 4. Normalized avalanche power derating versus pulse duration

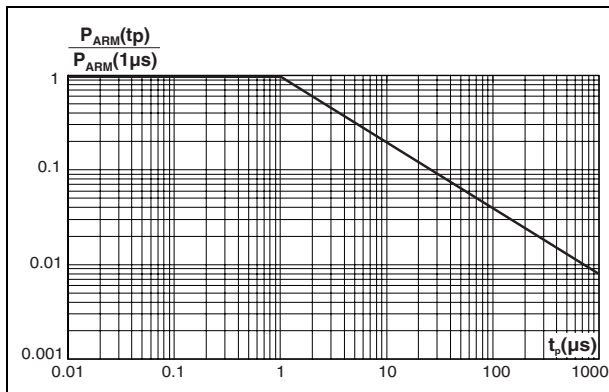

Figure 5. Normalized avalanche power derating versus junction temperature

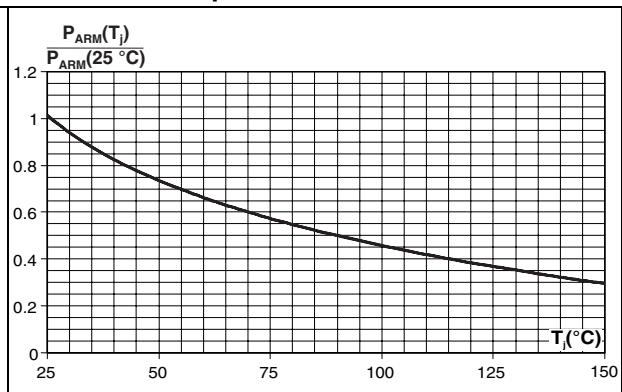

Figure 6. Non repetitive surge peak forward current versus overload duration (maximum values)

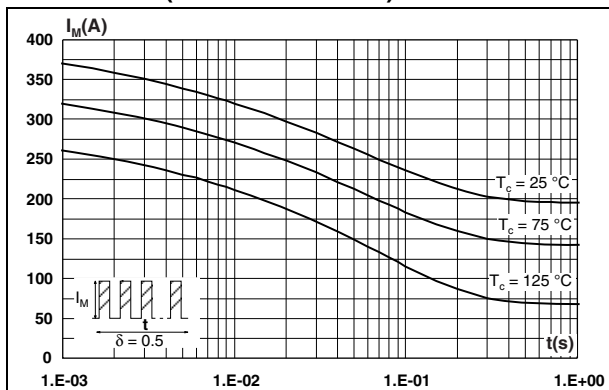

Figure 7. Relative variation of thermal impedance junction to case versus pulse duration

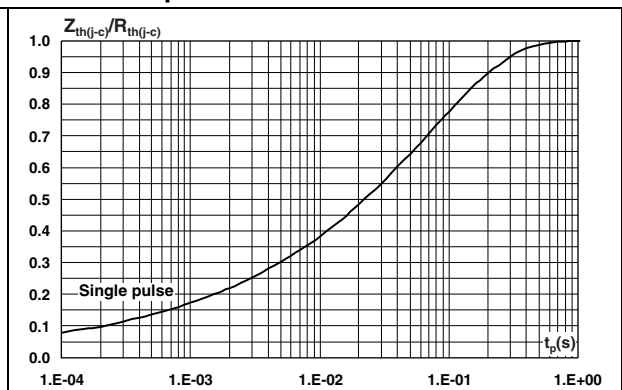

Figure 8. Reverse leakage current versus reverse voltage applied (typical values)

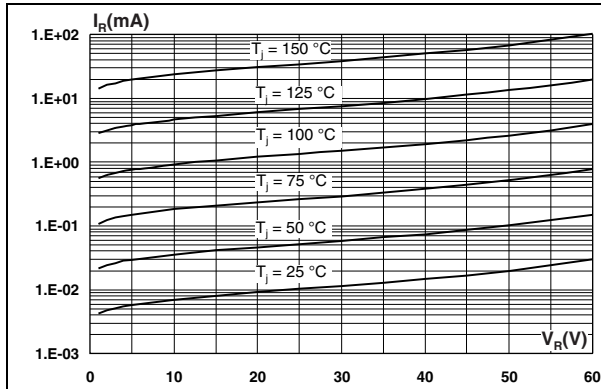

Figure 9. Junction capacitance versus reverse voltage applied (typical values)

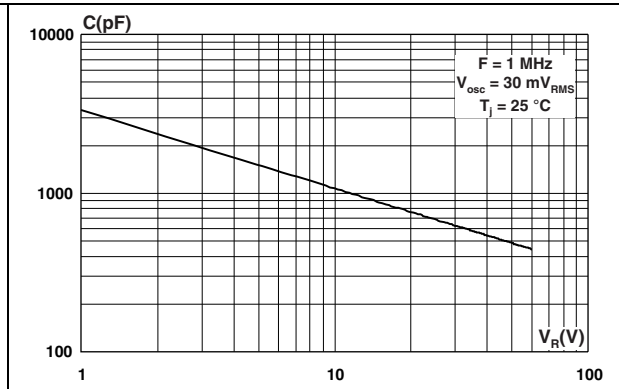

Figure 10. Forward voltage drop versus forward current

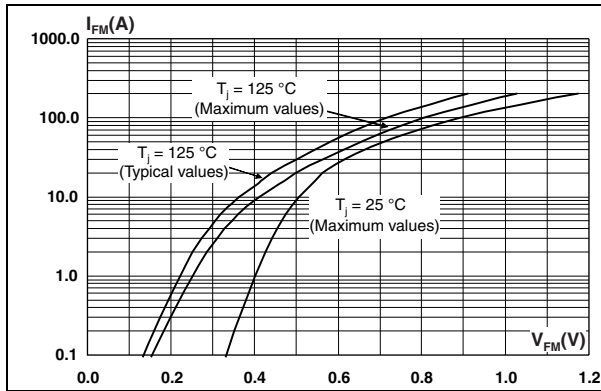

Figure 11. Thermal resistance junction to ambient versus copper surface under tab

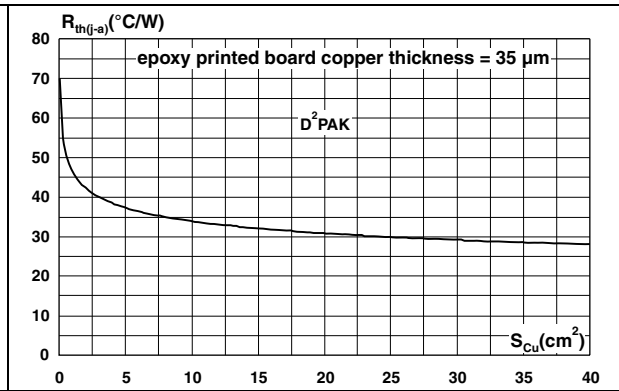
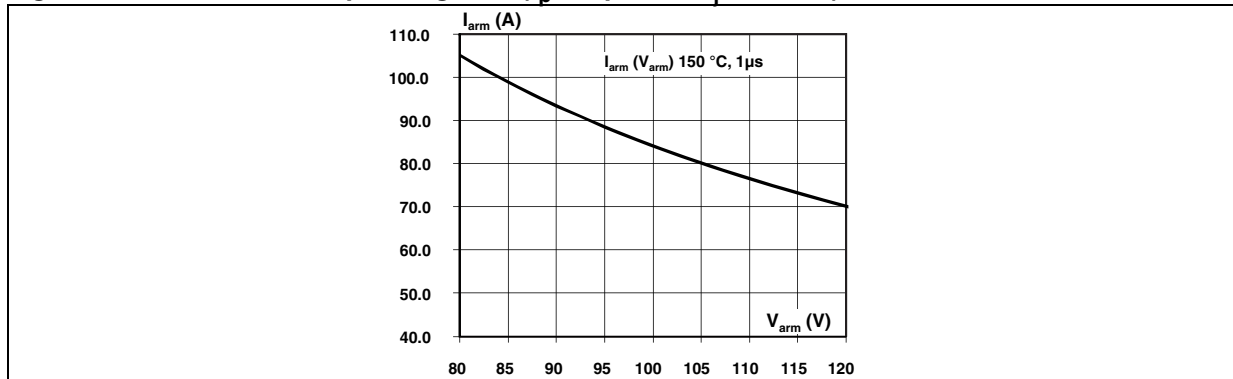

Figure 12. Reverse safe operating area ($t_p < 1 \mu\text{s}$ and $T_j < 150 \text{ °C}$)



2 Package information

- Epoxy meets UL94, V0
- Cooling method: by conduction (C)
- Recommended torque value: 0.4 to 0.6 N·m

In order to meet environmental requirements, ST offers these devices in different grades of ECOPACK® packages, depending on their level of environmental compliance. ECOPACK® specifications, grade definitions and product status are available at: www.st.com. ECOPACK® is an ST trademark.

Table 5. TO-220AB dimensions

Ref.	Dimensions			
	Millimeters		Inches	
	Min.	Max.	Min.	Max.
A	4.40	4.60	0.173	0.181
C	1.23	1.32	0.048	0.051
D	2.40	2.72	0.094	0.107
E	0.49	0.70	0.019	0.027
F	0.61	0.88	0.024	0.034
F1	1.14	1.70	0.044	0.066
F2	1.14	1.70	0.044	0.066
G	4.95	5.15	0.194	0.202
G1	2.40	2.70	0.094	0.106
H2	10	10.40	0.393	0.409
L2	16.4 Typ.		0.645 Typ.	
L4	13	14	0.511	0.551
L5	2.65	2.95	0.104	0.116
L6	15.25	15.75	0.600	0.620
L7	6.20	6.60	0.244	0.259
L9	3.50	3.93	0.137	0.154
M	2.6 Typ.		0.102 Typ.	
Dia.	3.75	3.85	0.147	0.151

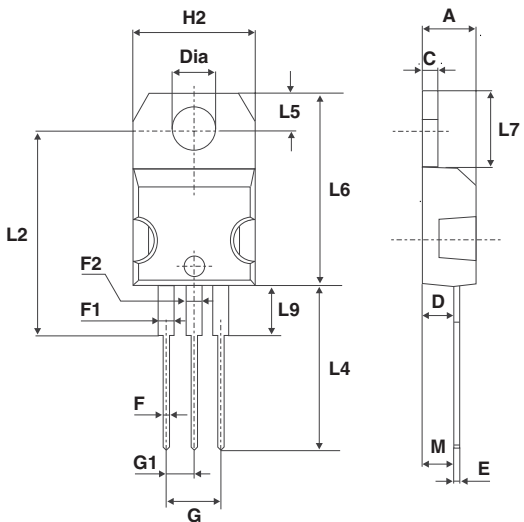

Table 6. D²PAK dimensions

Ref.	Dimensions			
	Millimeters		Inches	
	Min.	Max.	Min.	Max.
A	4.40	4.60	0.173	0.181
A1	2.49	2.69	0.098	0.106
A2	0.03	0.23	0.001	0.009
B	0.70	0.93	0.027	0.037
B2	1.14	1.70	0.045	0.067
C	0.45	0.60	0.017	0.024
C2	1.23	1.36	0.048	0.054
D	8.95	9.35	0.352	0.368
E	10.00	10.40	0.393	0.409
G	4.88	5.28	0.192	0.208
L	15.00	15.85	0.590	0.624
L2	1.27	1.40	0.050	0.055
L3	1.40	1.75	0.055	0.069
M	2.40	3.20	0.094	0.126
R	0.40 typ.		0.016 typ.	
V2	0°	8°	0°	8°

Figure 13. D²PAK footprint (dimensions in mm)

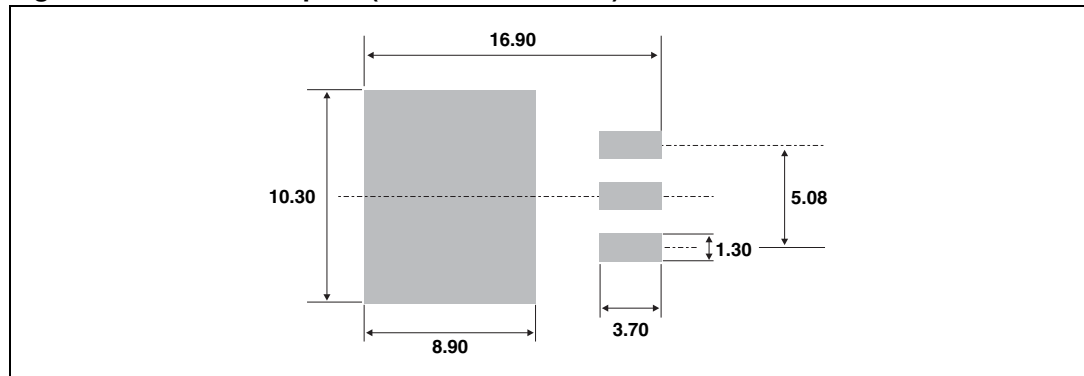

Table 7. I²PAK dimensions

Ref.	Dimensions			
	Millimeters		Inches	
	Min.	Max.	Min.	Max.
A	4.40	4.60	0.173	0.181
A1	2.40	2.72	0.094	0.107
b	0.61	0.88	0.024	0.035
b1	1.14	1.70	0.044	0.067
c	0.49	0.70	0.019	0.028
c2	1.23	1.32	0.048	0.052
D	8.95	9.35	0.352	0.368
e	2.40	2.70	0.094	0.106
e1	4.95	5.15	0.195	0.203
E	10	10.40	0.394	0.409
L	13	14	0.512	0.551
L1	3.50	3.93	0.138	0.155
L2	1.27	1.40	0.050	0.055

3 Ordering information

Table 8. Ordering information

Order code	Marking	Package	Weight	Base qty	Delivery mode
STPS30SM60ST	STPS30SM60ST	TO-220AB	2.2 g	50	Tube
STPS30SM60SR	STPS30SM60SR	I ² PAK	1.49 g	50	Tube
STPS30SM60SG-TR	STPS30SM60SG	D ² PAK	1.48 g	1000	Tape and reel

4 Revision history

Table 9. Revision history

Date	Revision	Changes
24-Oct-2011	1	First issue.

Please Read Carefully:

Information in this document is provided solely in connection with ST products. STMicroelectronics NV and its subsidiaries ("ST") reserve the right to make changes, corrections, modifications or improvements, to this document, and the products and services described herein at any time, without notice.

All ST products are sold pursuant to ST's terms and conditions of sale.

Purchasers are solely responsible for the choice, selection and use of the ST products and services described herein, and ST assumes no liability whatsoever relating to the choice, selection or use of the ST products and services described herein.

No license, express or implied, by estoppel or otherwise, to any intellectual property rights is granted under this document. If any part of this document refers to any third party products or services it shall not be deemed a license grant by ST for the use of such third party products or services, or any intellectual property contained therein or considered as a warranty covering the use in any manner whatsoever of such third party products or services or any intellectual property contained therein.

UNLESS OTHERWISE SET FORTH IN ST'S TERMS AND CONDITIONS OF SALE ST DISCLAIMS ANY EXPRESS OR IMPLIED WARRANTY WITH RESPECT TO THE USE AND/OR SALE OF ST PRODUCTS INCLUDING WITHOUT LIMITATION IMPLIED WARRANTIES OF MERCHANTABILITY, FITNESS FOR A PARTICULAR PURPOSE (AND THEIR EQUIVALENTS UNDER THE LAWS OF ANY JURISDICTION), OR INFRINGEMENT OF ANY PATENT, COPYRIGHT OR OTHER INTELLECTUAL PROPERTY RIGHT.

UNLESS EXPRESSLY APPROVED IN WRITING BY TWO AUTHORIZED ST REPRESENTATIVES, ST PRODUCTS ARE NOT RECOMMENDED, AUTHORIZED OR WARRANTED FOR USE IN MILITARY, AIR CRAFT, SPACE, LIFE SAVING, OR LIFE SUSTAINING APPLICATIONS, NOR IN PRODUCTS OR SYSTEMS WHERE FAILURE OR MALFUNCTION MAY RESULT IN PERSONAL INJURY, DEATH, OR SEVERE PROPERTY OR ENVIRONMENTAL DAMAGE. ST PRODUCTS WHICH ARE NOT SPECIFIED AS "AUTOMOTIVE GRADE" MAY ONLY BE USED IN AUTOMOTIVE APPLICATIONS AT USER'S OWN RISK.

Resale of ST products with provisions different from the statements and/or technical features set forth in this document shall immediately void any warranty granted by ST for the ST product or service described herein and shall not create or extend in any manner whatsoever, any liability of ST.

ST and the ST logo are trademarks or registered trademarks of ST in various countries.

Information in this document supersedes and replaces all information previously supplied.

The ST logo is a registered trademark of STMicroelectronics. All other names are the property of their respective owners.

© 2011 STMicroelectronics - All rights reserved

STMicroelectronics group of companies

Australia - Belgium - Brazil - Canada - China - Czech Republic - Finland - France - Germany - Hong Kong - India - Israel - Italy - Japan - Malaysia - Malta - Morocco - Philippines - Singapore - Spain - Sweden - Switzerland - United Kingdom - United States of America

www.st.com