



IEEE802.3af class 3 PoE converter reference design
high efficiency flyback converter based on the PM8800A

By Antonio Rotta

Introduction

The PM8800A is a highly integrated device embedding an IEEE802.3af compliant powered device (PD) interface together with a PWM controller and support for auxiliary sources.

This document focuses on a reference design for a high efficiency, class 3 PD (up to 13 W input) power converter based on a flyback topology with pulse transformer driven synchronous rectification using the PM8800A as the main controller.

Schematics of the PoE converter are given in [Section 2](#), while the related bill of material is detailed in [Section 3](#). In [Section 4](#) efficiency measurements together with main waveforms of the PoE interface and power converter are shown.

Contents

1	Electrical specifications	3
2	Schematics	4
3	Bill of material	6
4	Test results	8
4.1	Efficiency measurements	8
4.2	Waveforms	9
4.2.1	Startup sequence	9
4.2.2	Primary side MOSFET	10
4.2.3	Secondary side MOSFET	11
4.2.4	Load transient	12
4.2.5	Output ripple	13
5	Revision history	15

1 Electrical specifications

Table 1. Specifications for 3.3 V output

Parameter	Description	Min.	Typ.	Max.	Unit
Input voltage range	Applied at RJ45 connector	0		57	V
Operative input voltage		42		57	V
UVLO	Vin rising edge			36	V
	Vin falling edge	30			V
Auxiliary input voltage range		42	48	56	V
Output voltage (Vout)	Vin = 42 V to 57 V, Iout 0 to Imax	3.25	3.35	3.45	V
Output current (Iout)	Vin = 42 V to 57 V	0		3.5	A
Peak-to-peak output ripple	48 Vin, Iout = Imax		30	50	mVpp
Efficiency DC-DC only	Vin = 48 V, Iout = Imax		90		%
Overall efficiency	Vin = 48 V, Iout = Imax		88		%
Switching frequency			150		kHz

2 Schematics

Figure 1. High efficiency PoE converter schematic: detail of the input section including data transformers and terminations

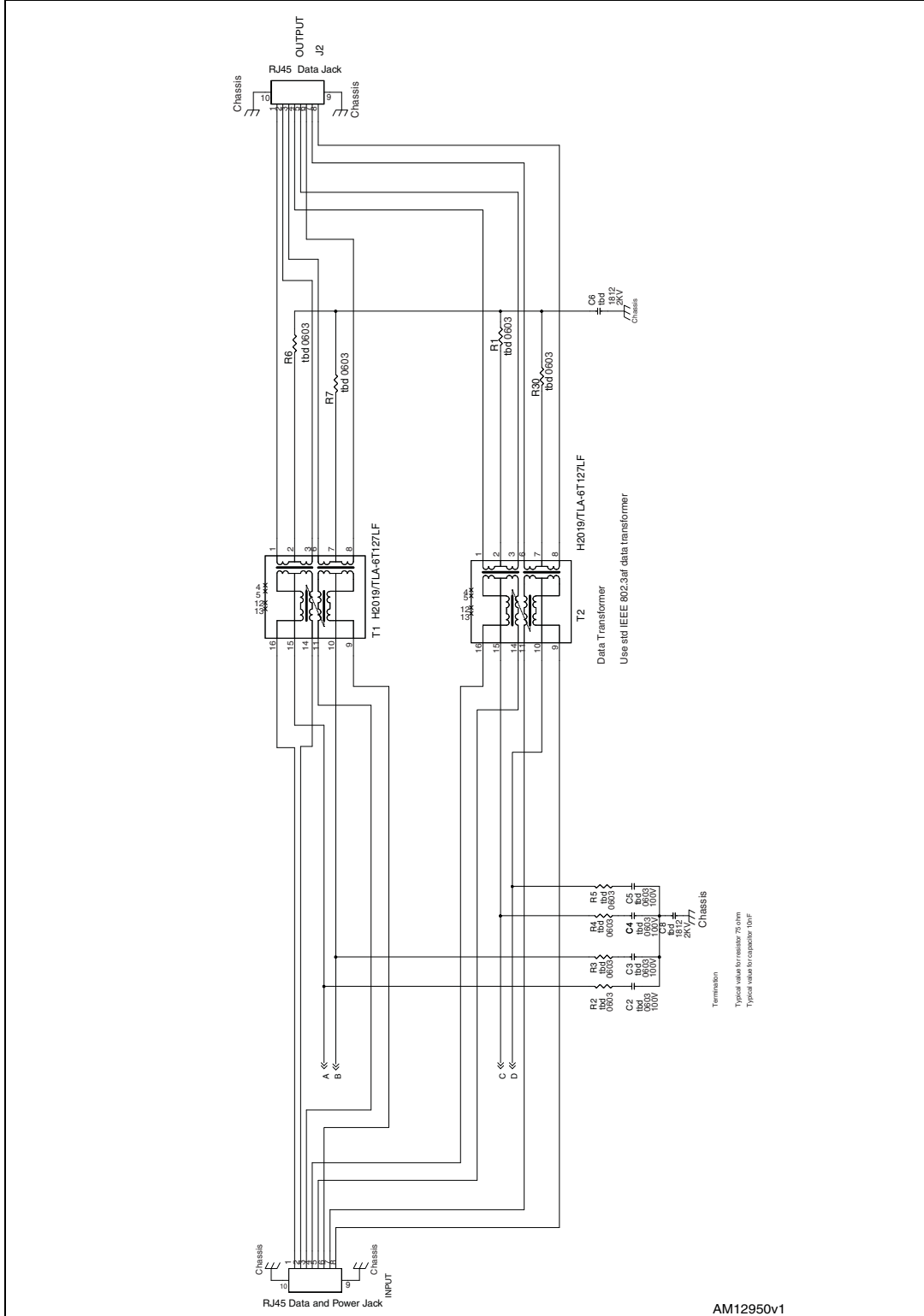
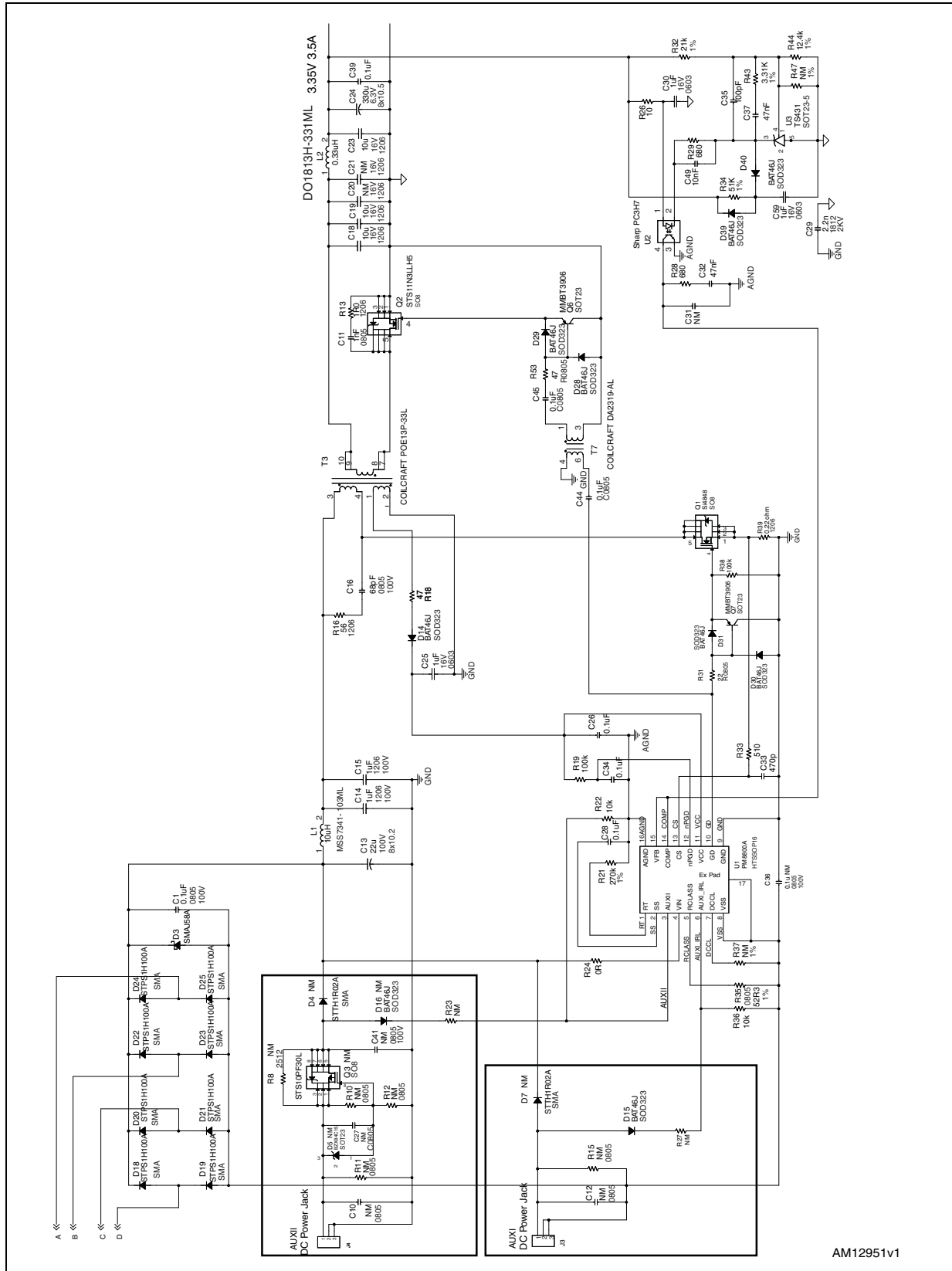

Figure 2. High efficiency PoE converter: flyback topology with pulse transformer driven synchronous rectification



3 Bill of material

Table 2. Bill of material

Qty.	Reference	Description	Value	Tol.	Voltage	Body	Vendor
1	C1	Ceramic capacitor	100 nF		100 V	603	TDK
4	C2, C3, C4, C5	Ceramic capacitor	TBD	10%	100 V	603	TDK
2	C6, C8	Ceramic capacitor	TBD		2 KV	1812	TDK
1	C11	Ceramic capacitor	1 nF	10%	100 V	805	TDK
1	C13	Aluminium capacitor	22 μ F	20%	100 V	810x10.2	Std low ESR
2	C14, C15	Ceramic capacitor	1 μ F	20%	100 V	1206	TDK
1	C16	Ceramic capacitor	68 pF		100 V	805	TDK
3	C18, C19, C23	Ceramic capacitor	10 μ F		6.3 V	805	TDK
1	C24	Aluminium capacitor	330 μ F		6.3 V	8x10.2	Std low ESR
3	C25, C30, C59	Ceramic capacitor	1 μ F	20%	16 V	603	Std
6	C26, C28, C34, C39, C44, C45	Ceramic capacitor	100 nF	20%	50 V	603	Std
1	C29	Ceramic capacitor	2.2 nF		2 KV	1812	TDK
2	C32, C37	Ceramic capacitor	47 nF		50 V	603	Std
1	C33	Ceramic capacitor	470 pF		50 V	603	Std
1	C49	Ceramic capacitor	10 nF	20%	50 V	603	Std
1	D3	TVS diode	SMAJ58A			SMA	ST
9	D14, D15, D28, D29, D30, D31, D39, D40	Schottky diode	BAT46J		100 V	SOD323	ST
8	D4, D7, D8, D9, D12, D13, D14, D17	Schottky diode	STPS1H100A		100 V	SMA	ST
1	L1	SMT inductor	10 μ H			MSS7341-103ML	Coilcraft
1	L2	SMT inductor	0.33 μ H			DO1813H-331ML	Coilcraft
1	Q1	MOSFET, N ch.	Si 4848		150 V	SO8	Vishay
1	Q2	MOSFET, N ch.	STS11N3LLH5		30 V	SO8	ST
2	Q6, Q7	Transistor, PNP	MMBT3906LT1		40 V	SOT23	Std
8	R1, R2, R3, R4, R5, R6, R7, R30	Chip resistor	TBD			603	Std

Table 2. Bill of material (continued)

Qty.	Reference	Description	Value	Tol.	Voltage	Body	Vendor
1	R13	Chip resistor	1R0			1206	Std
1	R16	Chip resistor	56			1206	Std
2	R18, R53	Chip resistor	47			603	Std
1	R19	Chip resistor	100 K			805	Std
1	R21	Chip resistor	270 K	1%		603	Std
2	R22, R36	Chip resistor	10 K			603	Std
1	R24	Chip resistor	0 R			603	Std
1	R26	Chip resistor	10 R			603	Std
2	R28, R29	Chip resistor	680			603	Std
1	R31	Chip resistor	22			603	Std
1	R32	Chip resistor	21 K	1%		603	Std
1	R33	Chip resistor	510			603	Std
1	R34	Chip resistor	51 K	1%		603	Std
1	R35	Chip resistor	52R3	1%		603	Std
1	R38	Chip resistor	100 K			603	Std
1	R39	Chip resistor	0.22 R			603	Std
1	R43	Chip resistor	3.31 K	1%		603	Std
1	R44	Chip resistor	12.4 K	1%		603	Std
2	T1, T2	POE+ magnetics	H2019				Pulse
1	T3	Power transformer	POE13P-33L				Coilcraft
1	T7	Gate driver transformer	DA2319-AL				Coilcraft
1	U1	POE controller	PM8800A			HTSSOP16	ST
1	U2	SMT optocoupler	PC3H7			4PDIP	Sharp
1	U3	Shunt regulator	TS431AILT			SOT23-5	ST

4 Test results

4.1 Efficiency measurements

Figure 3. Efficiency measurements at 48 V input

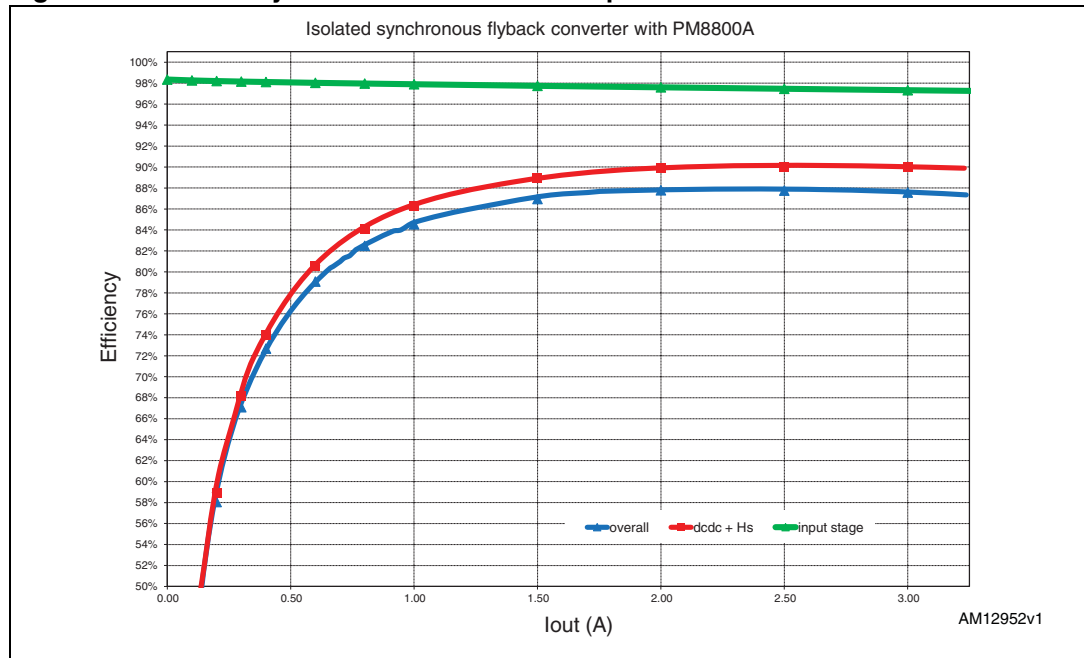

The difference between DC-DC and overall measurements is about 2% from 1 A to full load.

In [Figure 3](#) it is possible to see the contribution to the total losses of the PD interface section of the converter; the major contribution comes from the rectification bridge.

4.2 Waveforms

4.2.1 Startup sequence

Figure 4. Startup from the Cisco Catalyst 3750E switch with 3 A load

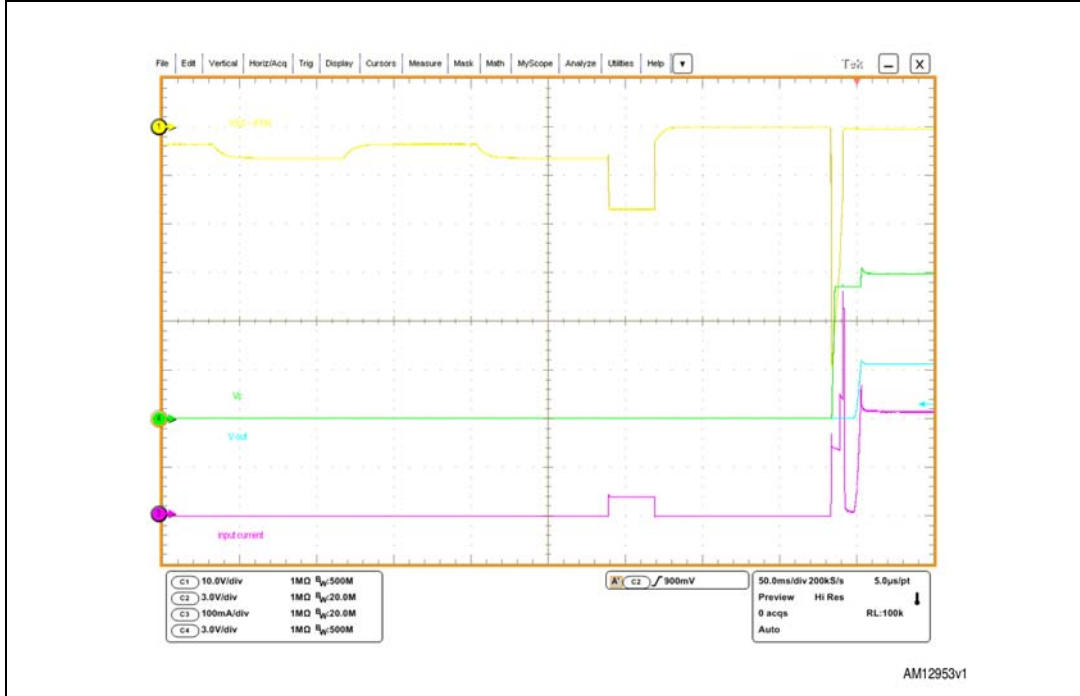

Figure 5. Startup from the PowerDsine 9001GR.at injector with 3 A load

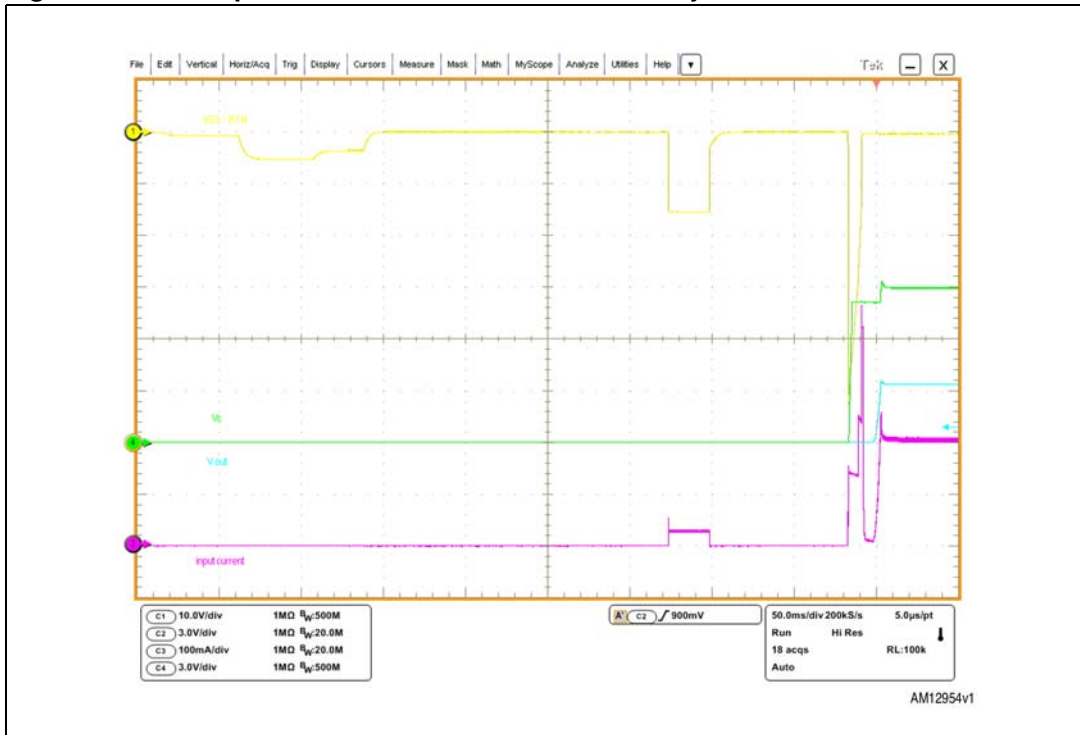
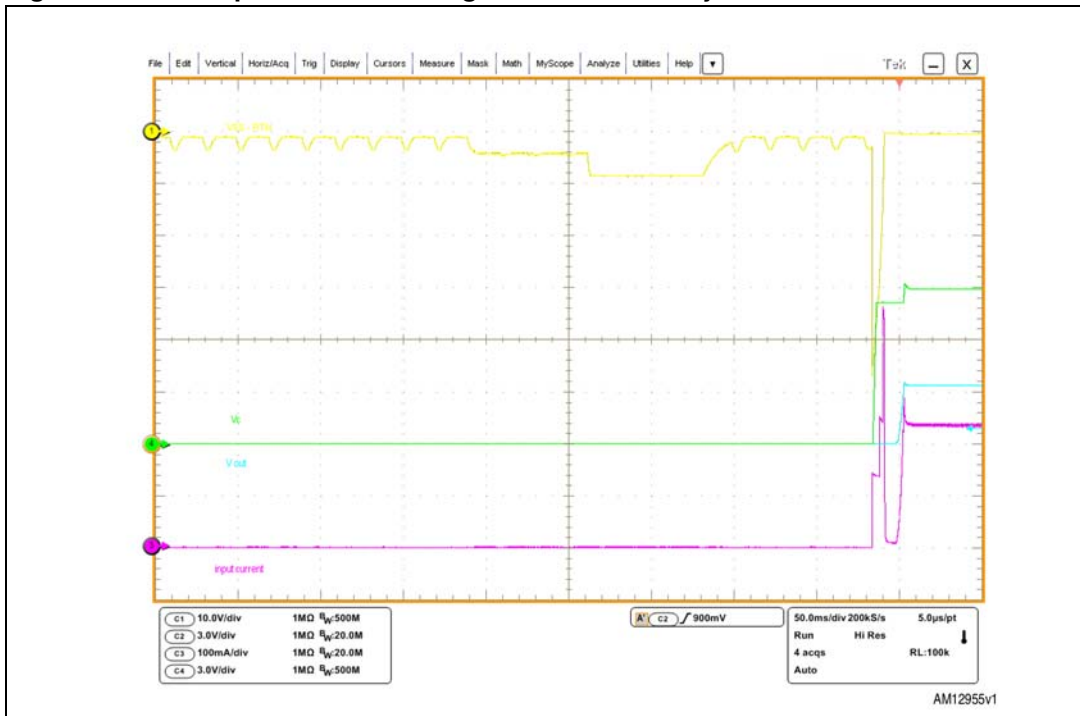

Figure 6. Startup from the Phihong PSA16U-480.af injector with 3 A load



4.2.2 Primary side MOSFET

Figure 7. Primary side Power MOSFET waveforms at 0 A load

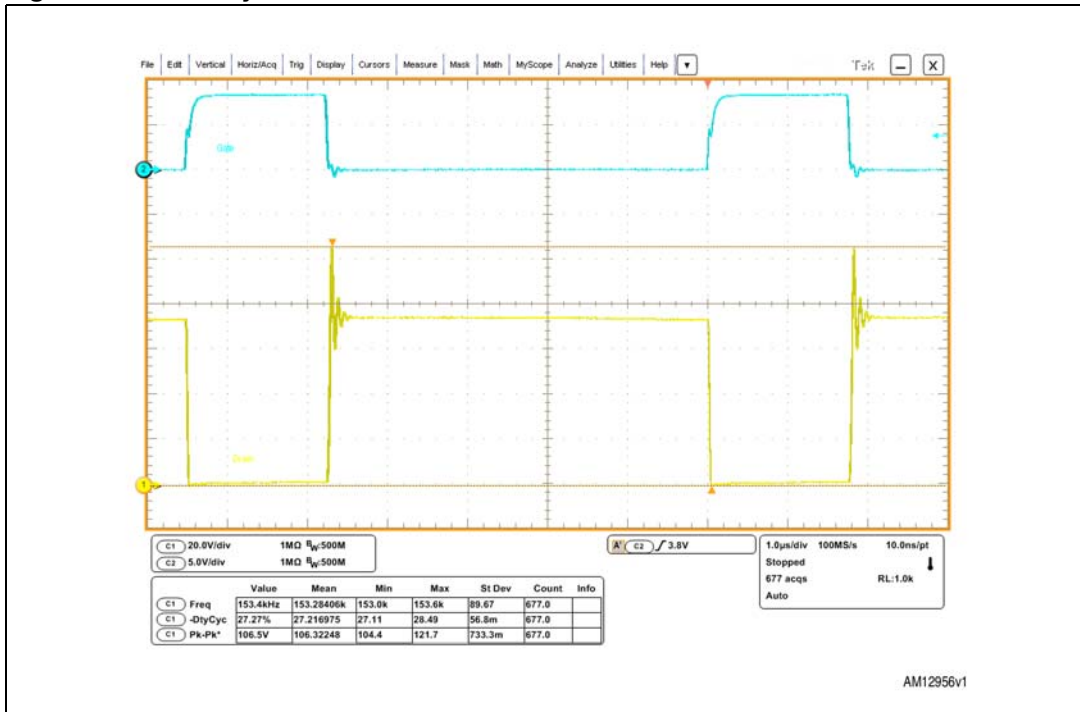
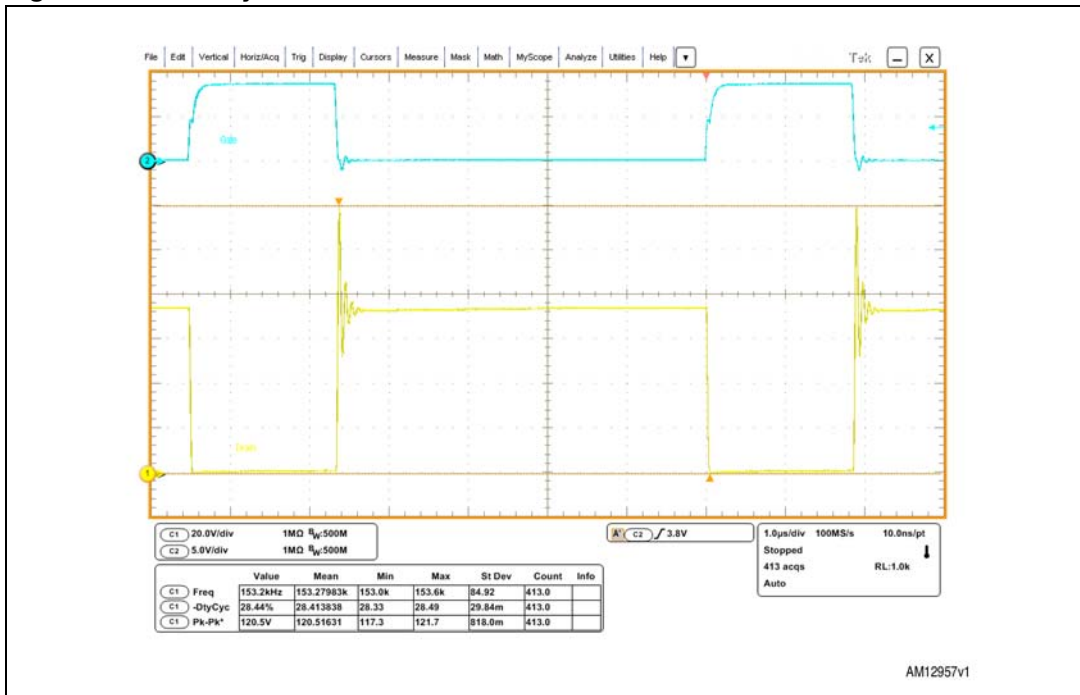

Figure 8. Primary side Power MOSFET waveforms at 3 A load



4.2.3 Secondary side MOSFET

Figure 9. Secondary side Power MOSFET waveforms at 0 A load

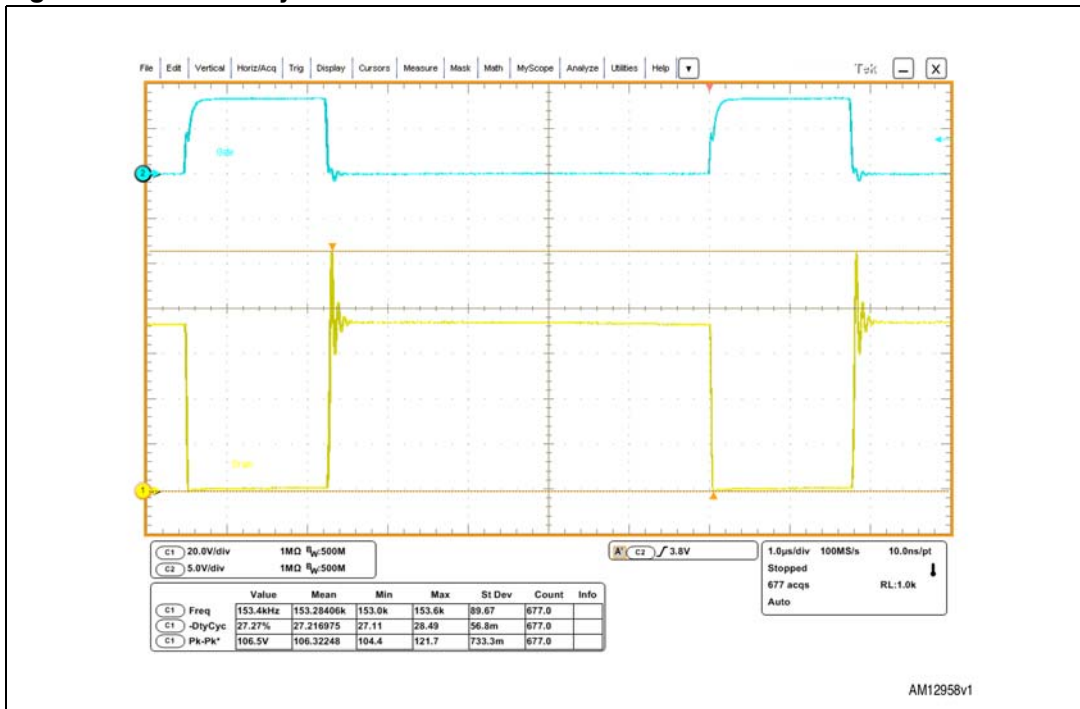
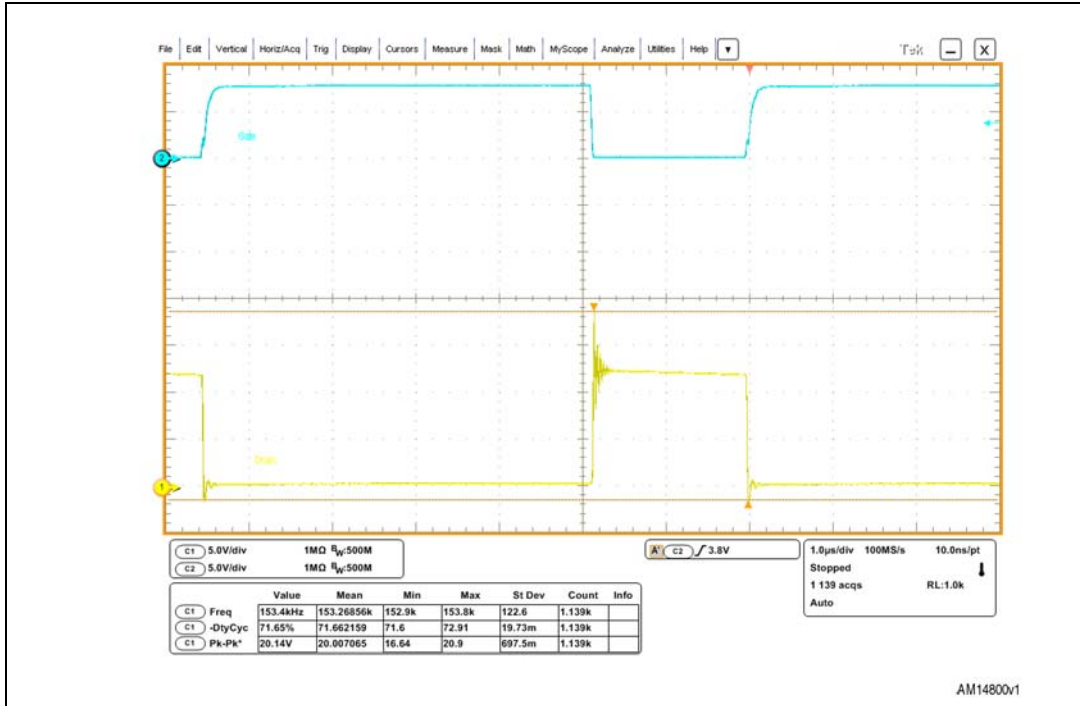
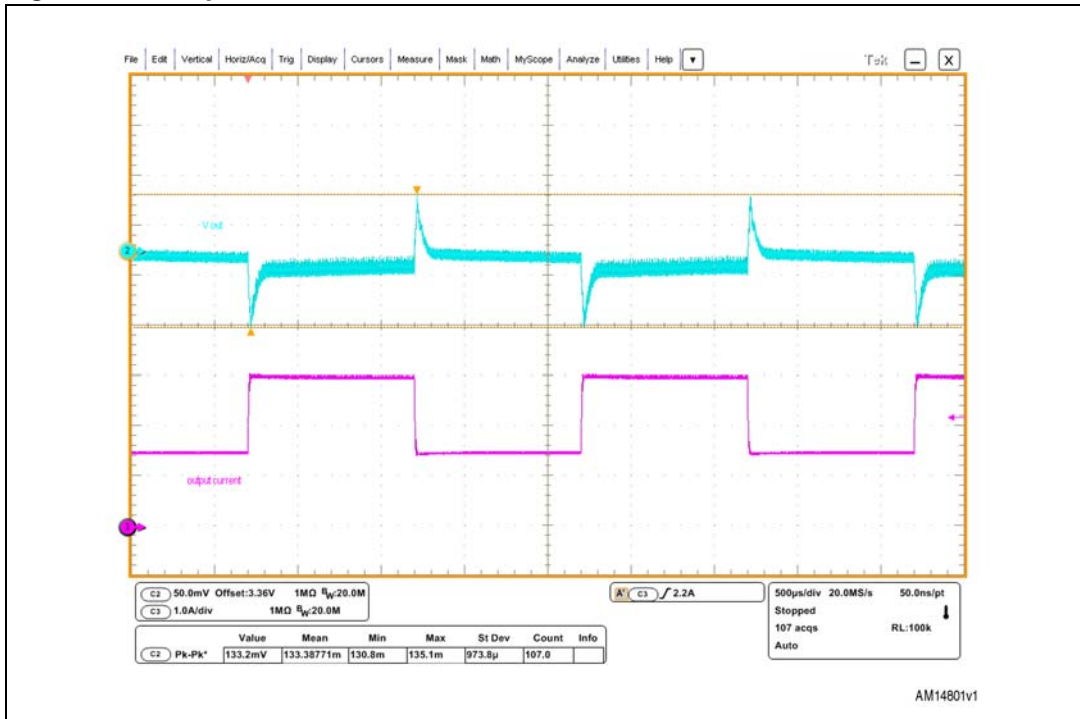

Figure 10. Secondary side Power MOSFET waveforms at 3 A load



4.2.4 Load transient

Figure 11. Response of the converter to a 1.5 A - 3 A load transient



4.2.5 Output ripple

Figure 12. Output ripple measurement at 3 A

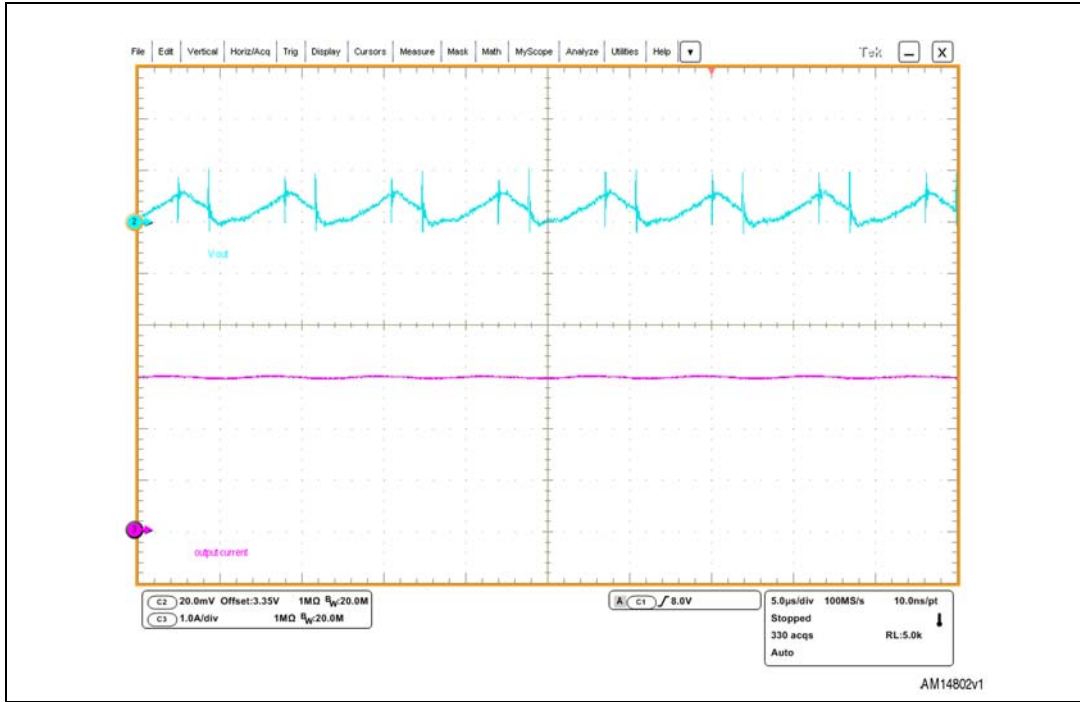

Figure 13. Output ripple measurement at 3 A with infinite persistence

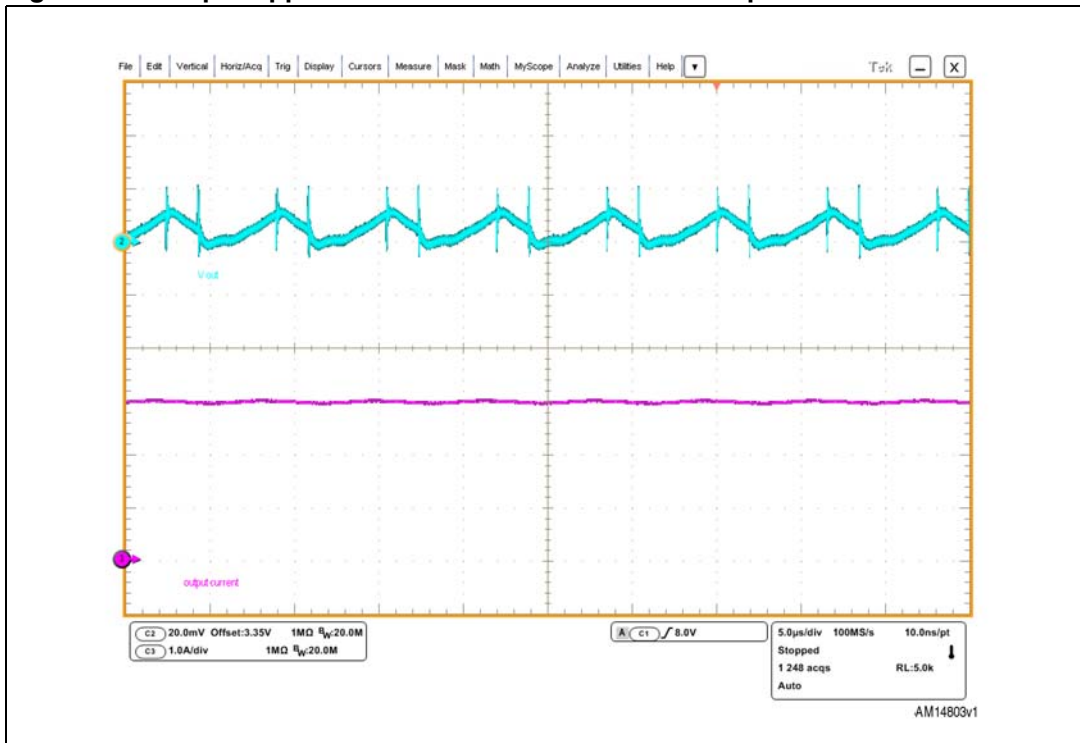
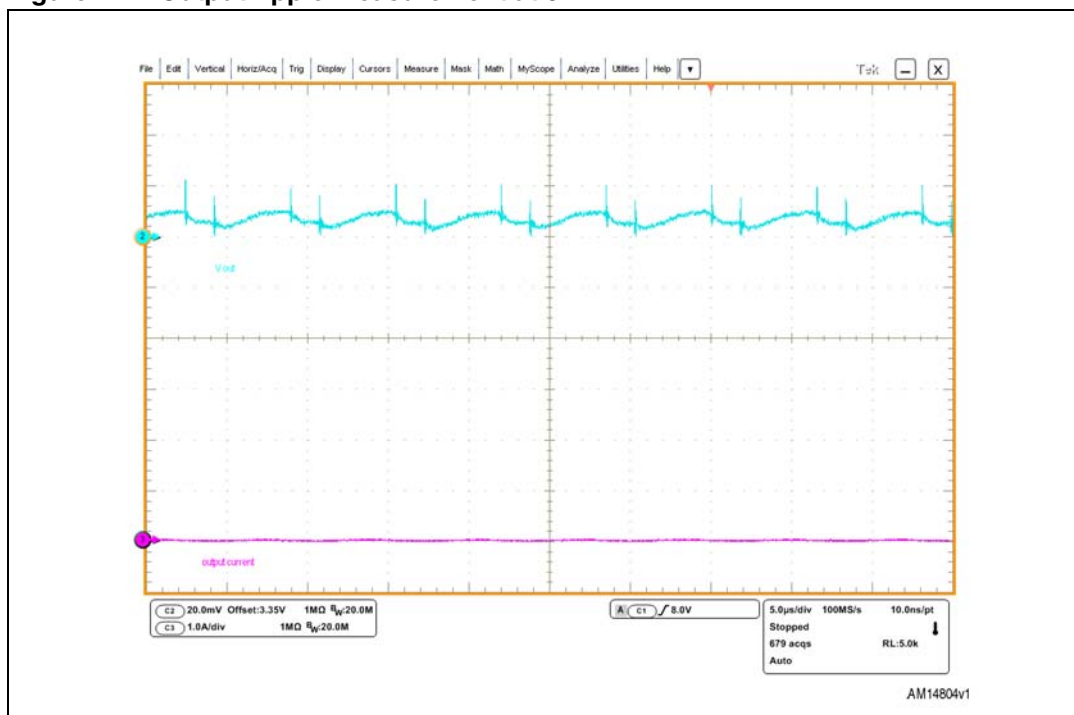

Figure 14. Output ripple measurement at 0 A



5 Revision history

Table 3. Document revision history

Date	Revision	Changes
02-Oct-2012	1	Initial release.

Please Read Carefully:

Information in this document is provided solely in connection with ST products. STMicroelectronics NV and its subsidiaries ("ST") reserve the right to make changes, corrections, modifications or improvements, to this document, and the products and services described herein at any time, without notice.

All ST products are sold pursuant to ST's terms and conditions of sale.

Purchasers are solely responsible for the choice, selection and use of the ST products and services described herein, and ST assumes no liability whatsoever relating to the choice, selection or use of the ST products and services described herein.

No license, express or implied, by estoppel or otherwise, to any intellectual property rights is granted under this document. If any part of this document refers to any third party products or services it shall not be deemed a license grant by ST for the use of such third party products or services, or any intellectual property contained therein or considered as a warranty covering the use in any manner whatsoever of such third party products or services or any intellectual property contained therein.

UNLESS OTHERWISE SET FORTH IN ST'S TERMS AND CONDITIONS OF SALE ST DISCLAIMS ANY EXPRESS OR IMPLIED WARRANTY WITH RESPECT TO THE USE AND/OR SALE OF ST PRODUCTS INCLUDING WITHOUT LIMITATION IMPLIED WARRANTIES OF MERCHANTABILITY, FITNESS FOR A PARTICULAR PURPOSE (AND THEIR EQUIVALENTS UNDER THE LAWS OF ANY JURISDICTION), OR INFRINGEMENT OF ANY PATENT, COPYRIGHT OR OTHER INTELLECTUAL PROPERTY RIGHT.

UNLESS EXPRESSLY APPROVED IN WRITING BY TWO AUTHORIZED ST REPRESENTATIVES, ST PRODUCTS ARE NOT RECOMMENDED, AUTHORIZED OR WARRANTED FOR USE IN MILITARY, AIR CRAFT, SPACE, LIFE SAVING, OR LIFE SUSTAINING APPLICATIONS, NOR IN PRODUCTS OR SYSTEMS WHERE FAILURE OR MALFUNCTION MAY RESULT IN PERSONAL INJURY, DEATH, OR SEVERE PROPERTY OR ENVIRONMENTAL DAMAGE. ST PRODUCTS WHICH ARE NOT SPECIFIED AS "AUTOMOTIVE GRADE" MAY ONLY BE USED IN AUTOMOTIVE APPLICATIONS AT USER'S OWN RISK.

Resale of ST products with provisions different from the statements and/or technical features set forth in this document shall immediately void any warranty granted by ST for the ST product or service described herein and shall not create or extend in any manner whatsoever, any liability of ST.

ST and the ST logo are trademarks or registered trademarks of ST in various countries.

Information in this document supersedes and replaces all information previously supplied.

The ST logo is a registered trademark of STMicroelectronics. All other names are the property of their respective owners.

© 2012 STMicroelectronics - All rights reserved

STMicroelectronics group of companies

Australia - Belgium - Brazil - Canada - China - Czech Republic - Finland - France - Germany - Hong Kong - India - Israel - Italy - Japan - Malaysia - Malta - Morocco - Philippines - Singapore - Spain - Sweden - Switzerland - United Kingdom - United States of America

www.st.com