

外形寸法図 Packaging Information /
 参考パターン寸法 Reference Pattern Layout Dimensions

USPN-6B01

●外形寸法図 / Packaging Information

Unit : inch (mm)

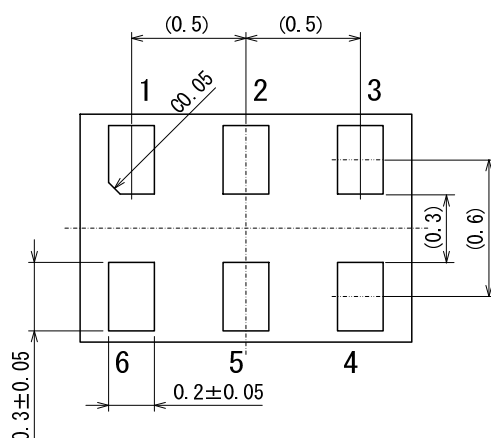
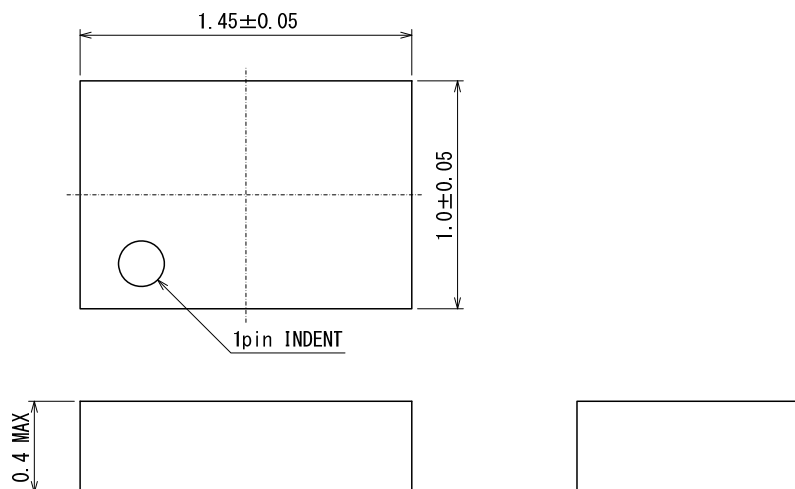

●参考パターンレイアウト/
 Reference Pattern Layout

●参考メタルマスクデザイン /
 Reference metal mask design

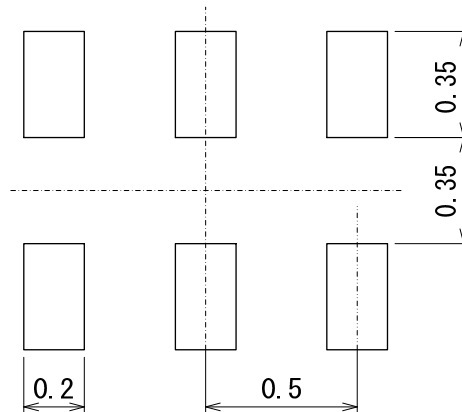
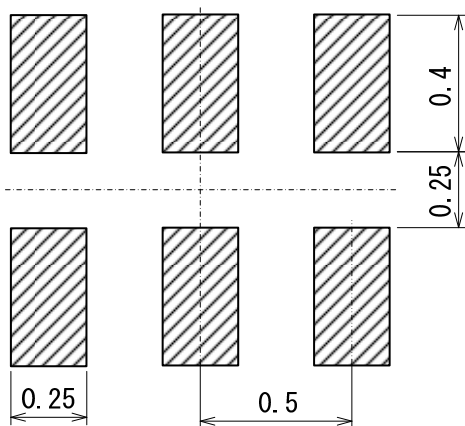

テーピング仕様 / Taping Specifications

USPN-6B01

●リール/Reel

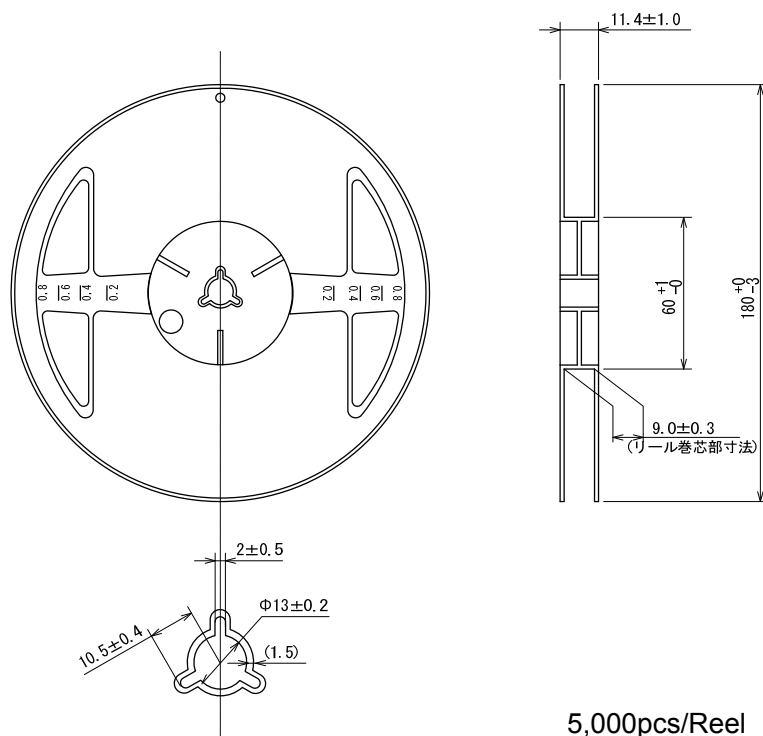

●テーピング仕様/Taping Specifications

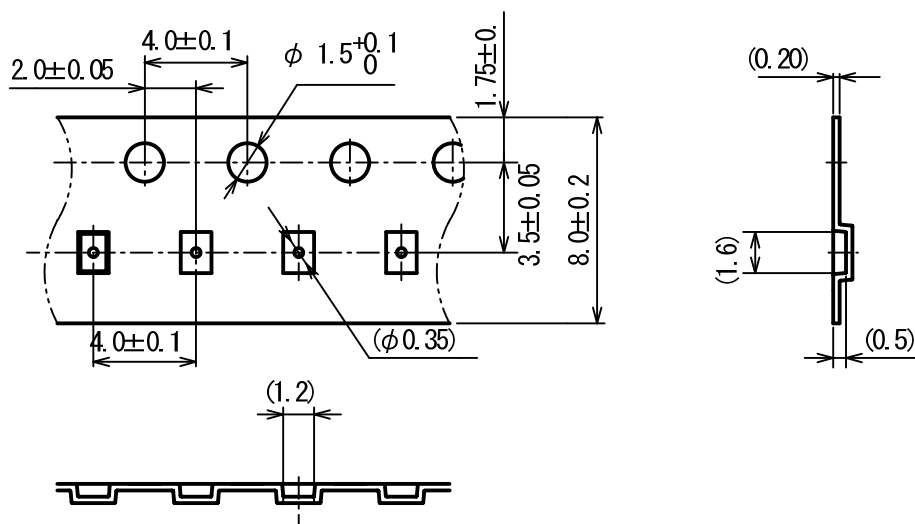

Direction of feed

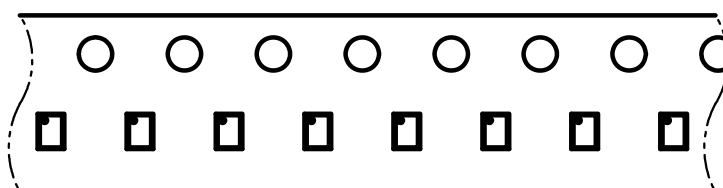

●USPN-6B01 Power Dissipation

Power dissipation data for the USPN-6B01 is shown in this page.

The value of power dissipation varies with the mount board conditions.

Please use this data as one of reference data taken in the described condition.

1. Measurement Condition (Reference data)

Condition : Mount on a board

Ambient : Natural convection

Soldering : Lead (Pb) free

Board : Dimensions 40mm x 40 mm (1600mm²)

Copper (Cu) traces occupy 50% of the front and 50% of the back.

VSS pin is tied to the copper traces

Material : Glass Epoxy (FR-4)

Thickness : 1.6mm

Through-hole : 4 x 0.8 Diameter

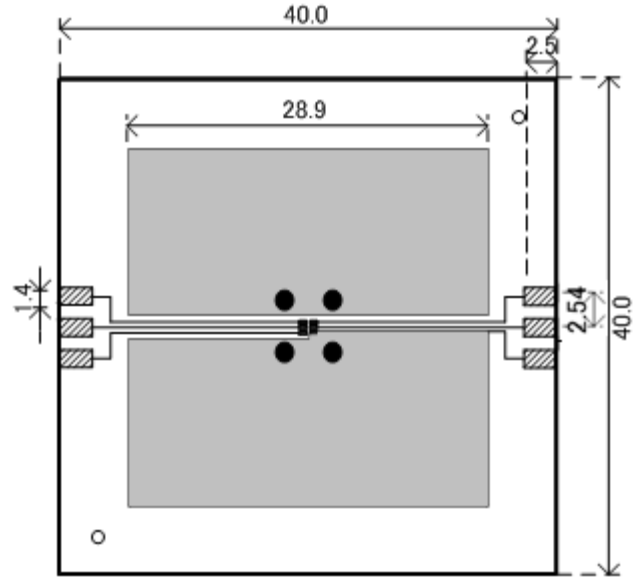

Evaluation Board (Unit: mm)

2. Power Dissipation vs. Ambient temperature

Board Mount (T_{jmax}=125°C)

Ambient Temperature (°C)	Power Dissipation Pd (mW)	Thermal Resistance (°C/W)
25	600	166.67
85	240	

