

Typical Applications

The HMC907LP5E is ideal for:

- Test Instrumentation
- Microwave Radio & VSAT
- Military & Space
- Telecom Infrastructure
- Fiber Optics

Features

- High P1dB Output Power: +26 dBm
- High Gain: 12 dB
- High Output IP3: +36 dBm
- Single Supply: +10 V @ 350 mA
- 50 Ohm Matched Input/Output
- 32 Lead 5x5 mm SMT Package: 25 mm²

Functional Diagram

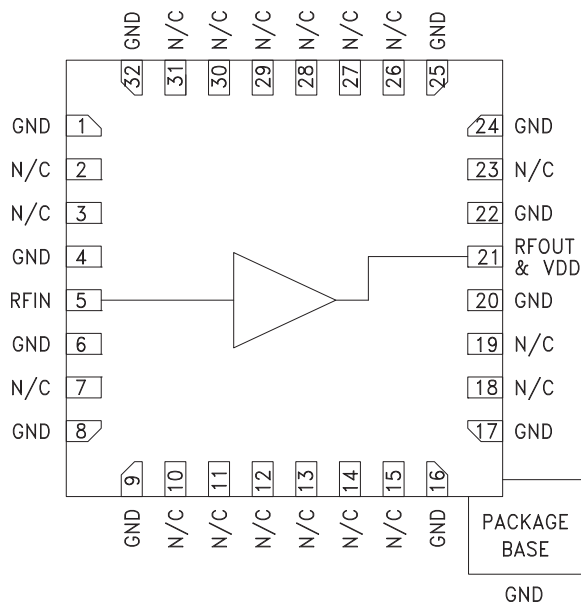

General Description

The HMC907LP5E is a GaAs MMIC pHEMT Distributed Power Amplifier which operates between 0.2 and 22 GHz. This self-biased power amplifier provides 12 dB of gain, +36 dBm output IP3 and +26 dBm of output power at 1 dB gain compression while requiring only 350 mA from a +10 V supply. Gain flatness is excellent at ±0.7 dB from 0.2 to 22 GHz making the HMC907LP5E ideal for EW, ECM, Radar and test equipment applications. The HMC907LP5E amplifier I/Os are internally matched to 50 Ohms facilitating integration into Multi-Chip-Modules (MCMs) and is packaged in a leadless QFN 5x5 mm surface mount package, and requires no external matching components.

Electrical Specifications, $T_A = +25\text{ }^\circ\text{C}$, $V_{dd} = +10\text{ V}$, $I_{dd} = 350\text{ mA}$

Parameter	Min.	Typ.	Max.	Min.	Typ.	Max.	Min.	Typ.	Max.	Units
Frequency Range	0.2 - 10			10 - 18			18 - 22			GHz
Gain	10	12		10	11.5		10	11.5		dB
Gain Flatness		±0.7			±0.6			±0.7		dB
Gain Variation Over Temperature		0.01			0.013			0.014		dB/ °C
Input Return Loss		15			9			8		dB
Output Return Loss		13			12			8		dB
Output Power for 1 dB Compression (P1dB)	23	26		21	25		19.5	21.5		dBm
Saturated Output Power (P _{sat})		28.5			27			24.5		dBm
Output Third Order Intercept (IP3)		36			34			31		dBm
Noise Figure		3.5			3.5			4		dB
Supply Current (I _{dd}) (V _{dd} = 10V)		350	400		350	400		350	400	mA

Gain & Return Loss

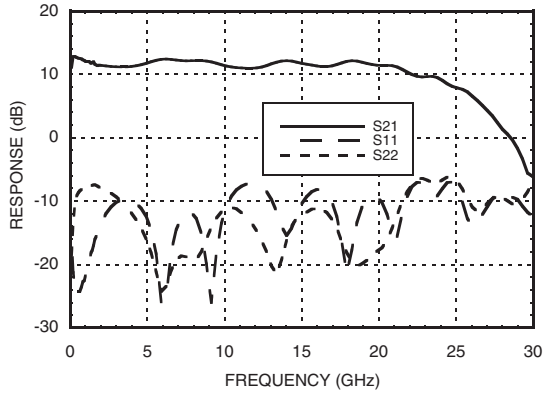

Gain vs. Temperature

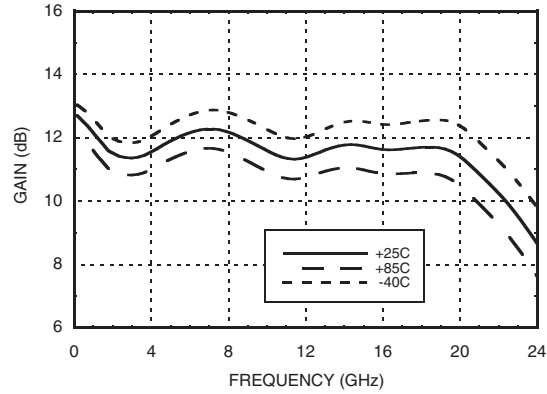

Input Return Loss vs. Temperature

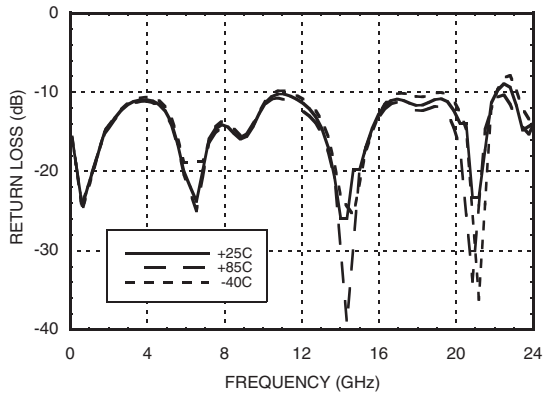

Output Return Loss vs. Temperature

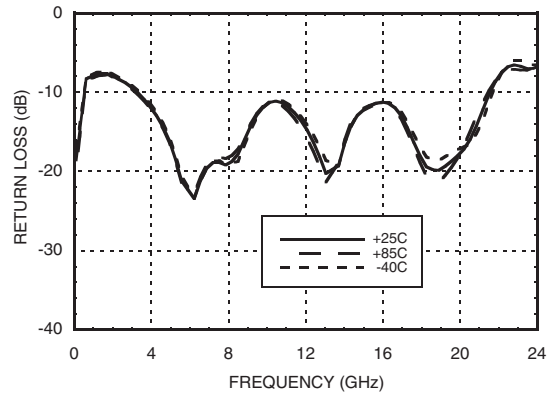

Reverse Isolation vs. Temperature

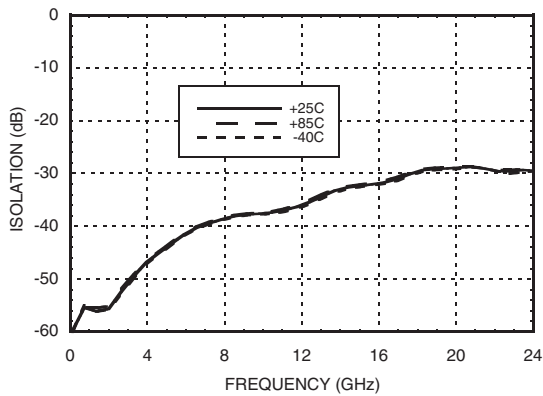

Gain vs. Vdd

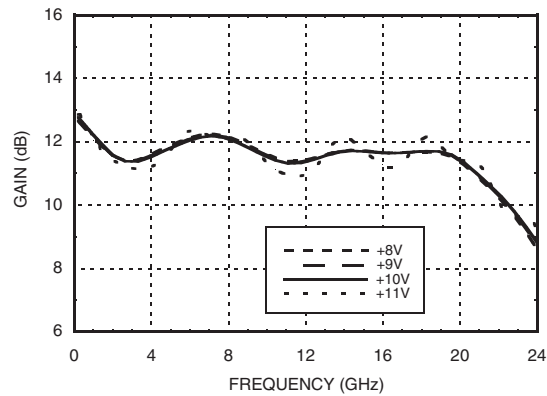



MICROWAVE CORPORATION v00.0510



HMC907LP5E

GaAs pHEMT MMIC POWER AMPLIFIER, 0.2 - 22 GHz

Low Frequency Gain & Return Loss

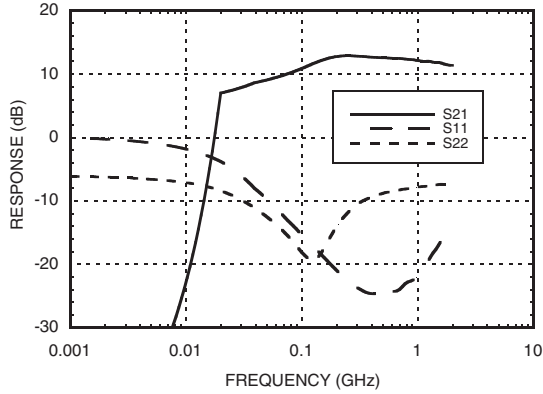

Noise Figure

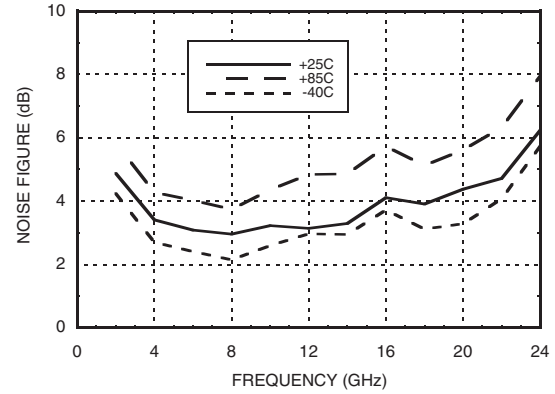

P1dB vs. Temperature

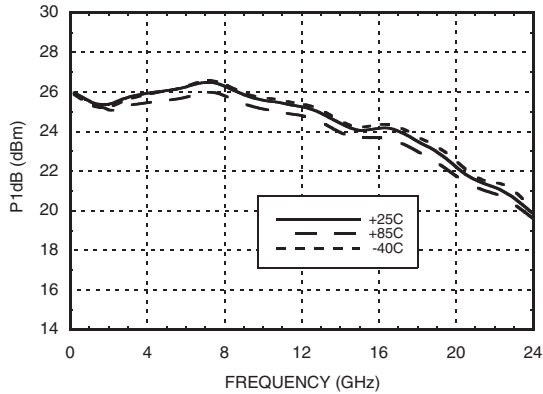

P1dB vs. Vdd

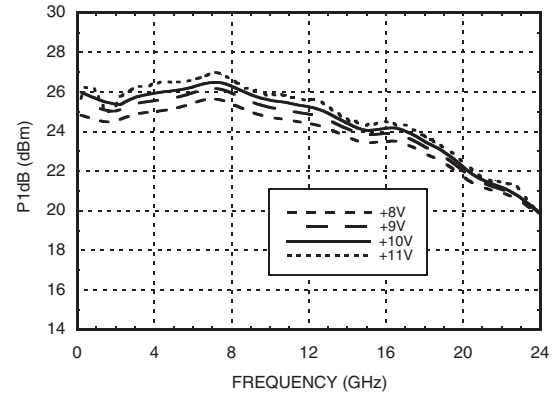

Psat vs. Temperature

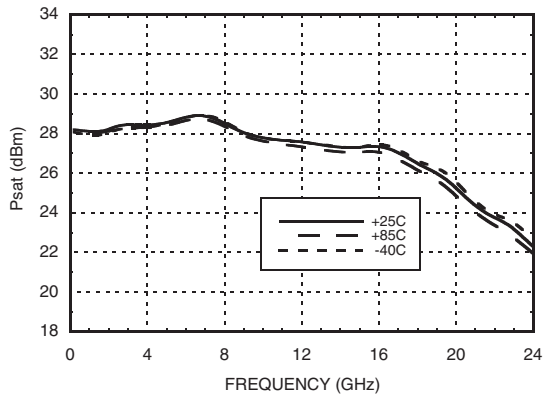

Psat vs. Vdd

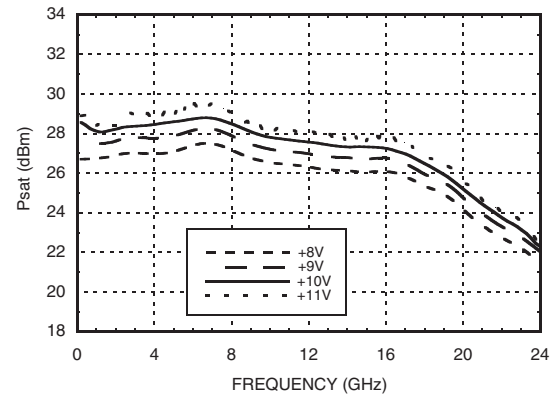

**Output IP3 vs.
Temperature @ Pout = 16 dBm / Tone**

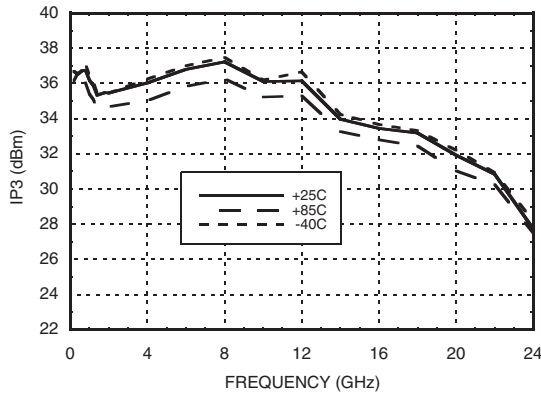

Output IP3 vs. Vdd @ Pout = 16 dBm / Tone

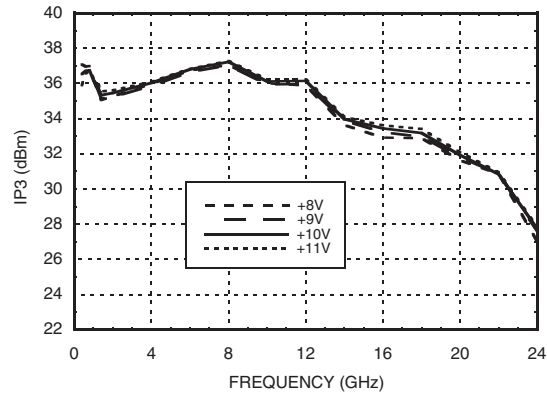

Output IM3 @ Vdd = 8V

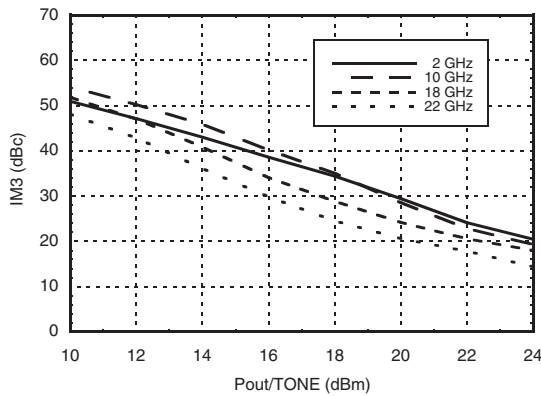

Output IM3 @ Vdd = 9V

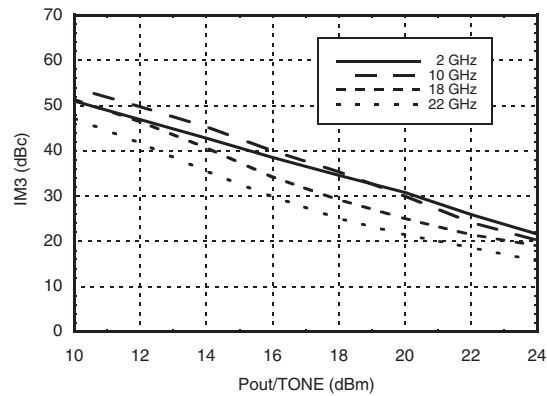

Output IM3 @ Vdd = 10V

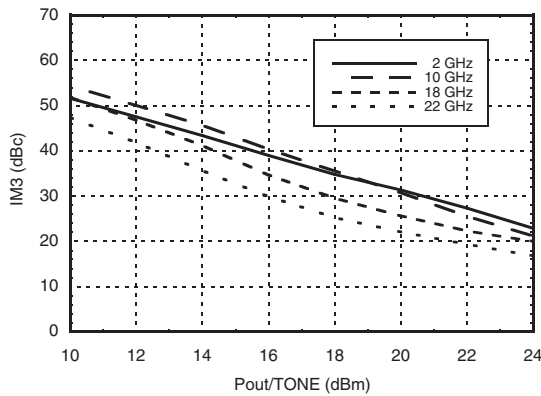

Output IM3 @ Vdd = 11V

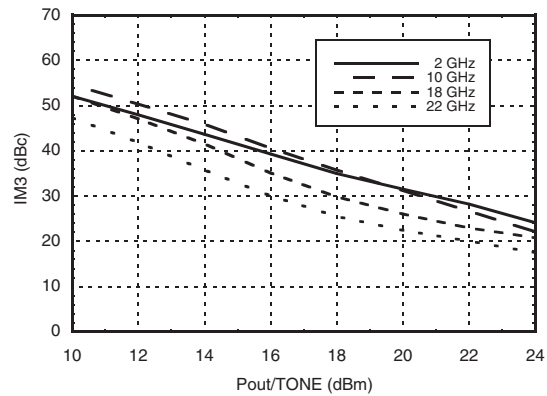



**GaAs pHEMT MMIC
POWER AMPLIFIER, 0.2 - 22 GHz**

Power Compression @ 10 GHz

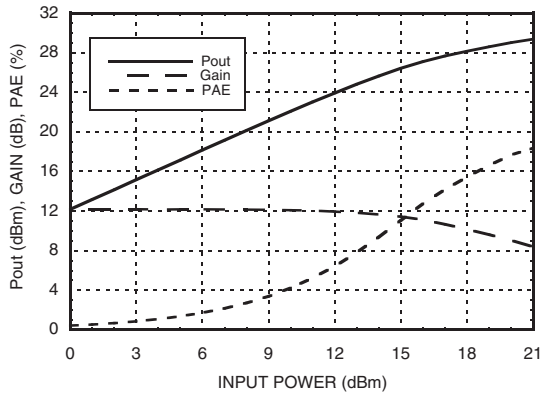

Gain & Power Supply vs. Supply Current @ 10 GHz

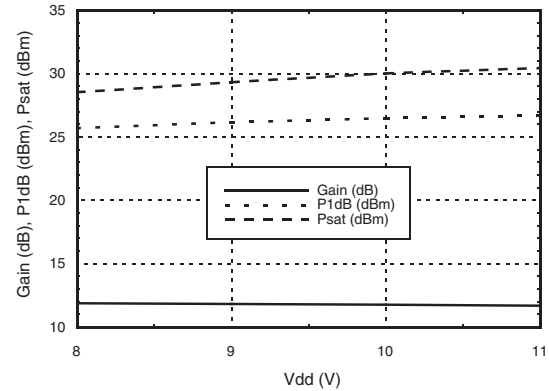

Power Dissipation

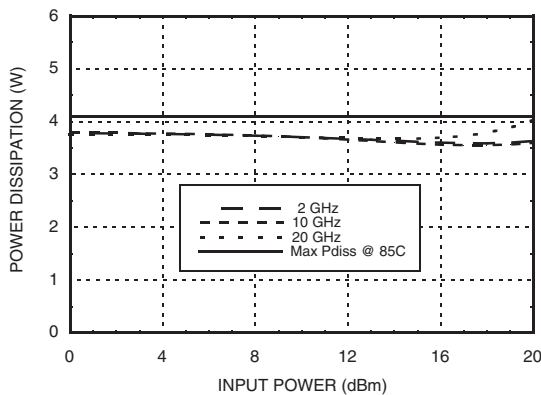

Second Harmonics vs. Temperature @ Pout = 16 dBm, Vdd = 10V

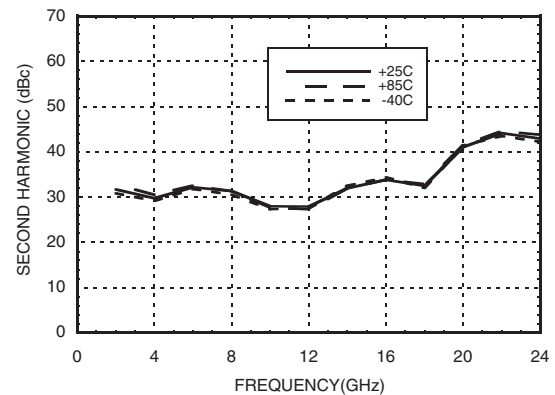

Second Harmonics vs. Vdd @ Pout = 16 dBm

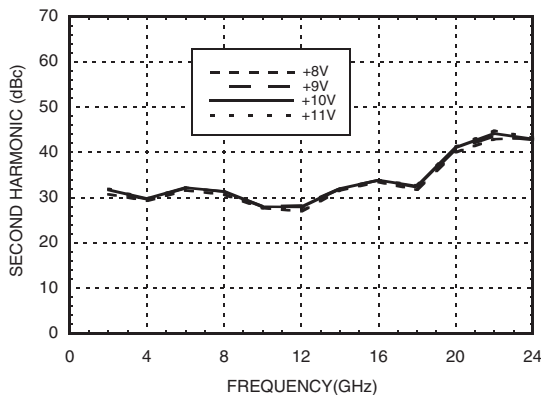

Second Harmonics vs. Pout @ Vdd = 10V

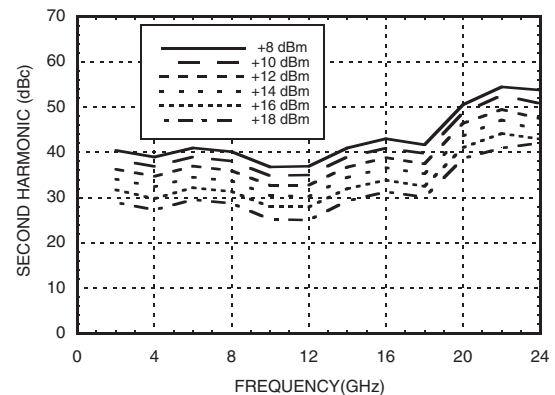

Absolute Maximum Ratings

Drain Bias Voltage (Vdd)	+11 Vdc
RF Input Power (RFIN)(Vdd = +11V)	+20 dBm
Channel Temperature	150 °C
Continuous Pdiss (T= 85 °C) (derate 63 mW/°C above 85 °C)	4.1 W
Thermal Resistance (channel to ground paddle)	15.9 °C/W
Storage Temperature	-65 to 150°C
Operating Temperature	-55 to 85 °C
ESD Sensitivity (HBM)	Class 1A

Typical Supply Current vs. Vdd

Vdd (V)	Idd (mA)
+8	335
+9	343
+10	350
+11	357



ELECTROSTATIC SENSITIVE DEVICE
OBSERVE HANDLING PRECAUTIONS

9

Outline Drawing

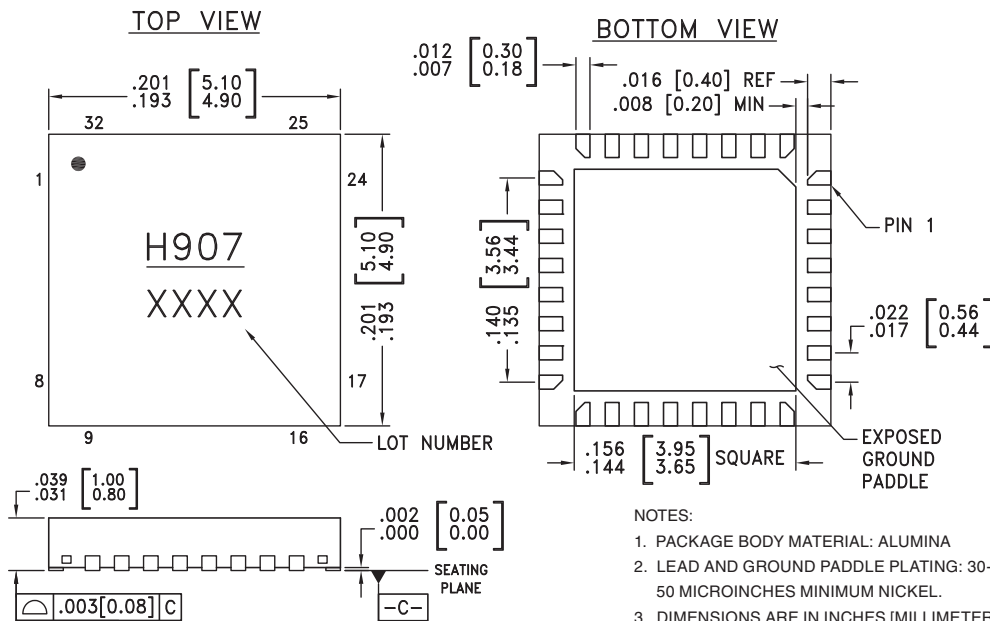

Package Information

Part Number	Package Body Material	Lead Finish	MSL Rating	Package Marking ^[1]
HMC907LP5E	RoHS-compliant Low Stress Injection Molded Plastic	100% matte Sn	MSL1 ^[2]	H907 XXXX

[1] 4-Digit lot number XXXX

[2] Max peak reflow temperature of 260 °C

Pin Descriptions

Pin Number	Function	Description	Interface Schematic
1, 4, 6, 8, 9, 16, 17, 20, 22, 24, 25, 32	GND	Package bottom has exposed metal paddle that must be connected to RF/DC ground.	
2, 3, 7, 10 - 15, 18, 19, 23, 26 - 31	N/C	The pins are not connected internally; however, all data shown herein was measured with these pins connected to RF/DC ground externally.	
5	RFIN	This pin is DC coupled and matched to 50 Ohms. Blocking capacitor is required.	
21	RFOUT & Vdd	RF output for amplifier. Connect DC bias (Vdd) network to provide drain current (Idd). See application circuit herein.	

Application Circuit

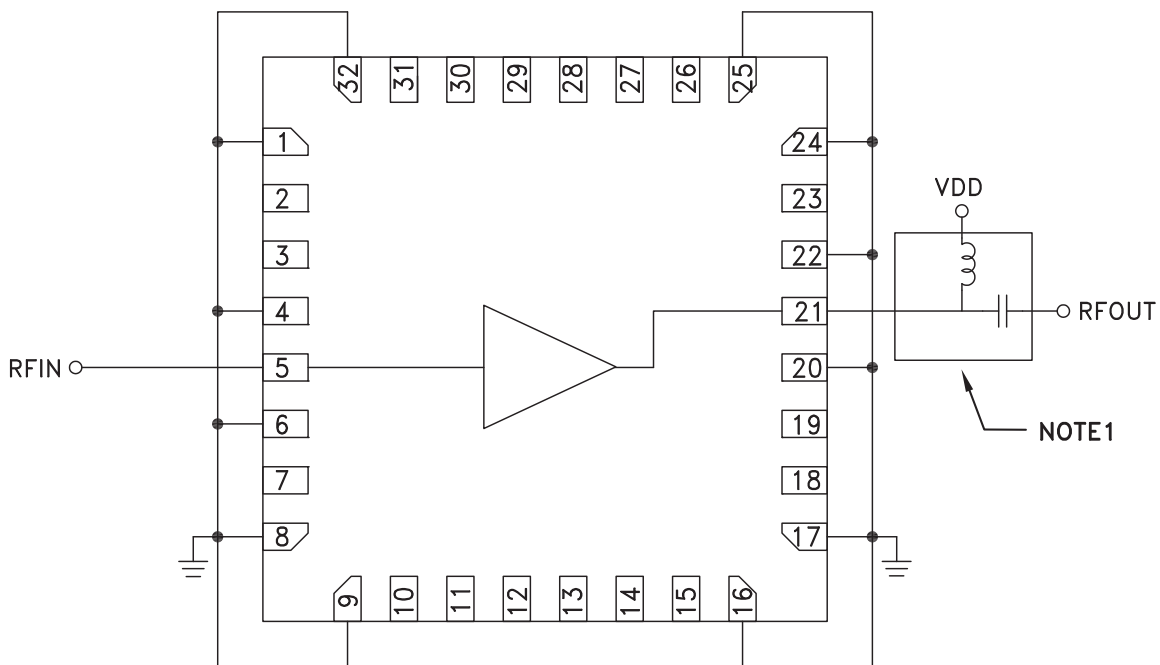

NOTE 1: Drain Bias (Vdd) must be applied through a broadband bias tee or external bias network.

Evaluation PCB

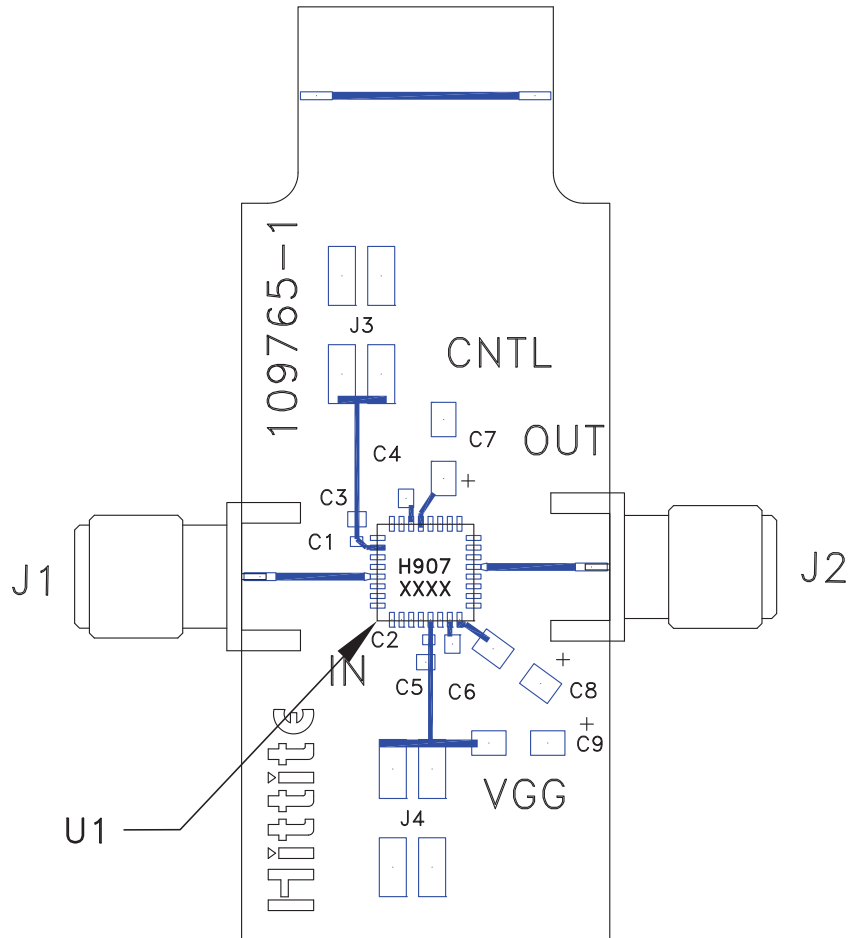

List of Materials for Evaluation PCB 130812 [1]

Item	Description
J1, J2	SMA Connector
U1	HMC907LP5E Power Amplifier
PCB [2]	109765 Evaluation PCB

[1] Reference this number when ordering complete evaluation PCB

[2] Circuit Board Material: Rogers 4350 or Arlon FR4

The circuit board used in the application should use RF circuit design techniques. Signal lines should have 50 Ohm impedance while the package ground leads and exposed paddle should be connected directly to the ground plane similar to that shown. A sufficient number of via holes should be used to connect the top and bottom ground planes. The evaluation board should be mounted to an appropriate heat sink. The evaluation circuit board shown is available from Hittite upon request.