

Control Integrated Power System (CIPOS™)

IGCM20F60HA

<http://www.lspst.com>



For Power Management
Application

LS Power Semitech
A joint venture with infineon

Revision History:	2011-10	Ver.1.5
Previous Version:	Datasheet Ver. 1.4	
Page	Subjects (major changes since last revision)	
8	Inverter section : Ratings of V_{PN} , $V_{PN(surge)}$ are added	

Authors: Junho Lee, Bumseung Jin, Junbae Lee and Daewoong Chung

Edition 2010-07

Published by
LS Power Semitech Co., Ltd.
Seoul, Korea

© LS Power Semitech Co., Ltd.
All Rights Reserved.

Attention please!

The information given in this data sheet shall in no event be regarded as a guarantee of conditions or characteristics. With respect to any examples or hints given herein, any typical values stated herein and/or any information regarding the application of the device, LS Power Semitech Co., Ltd. hereby disclaims any and all warranties and liabilities of any kind, including without limitation warranties of non-infringement of intellectual property rights of any third party.

Information

For further information on technology, delivery terms and conditions and prices please contact your nearest LS Power Semitech Co., Ltd. office or representatives (<http://www.lspst.com>).

Warnings

Due to technical requirements components may contain dangerous substances. For information on the types in question please contact your nearest LS Power Semitech Co., Ltd. office or representatives.

LS Power Semitech Co., Ltd. components may only be used in life-support devices or systems with the express written approval LS Power Semitech Co., Ltd., if a failure of such components can reasonably be expected to cause the failure of that life-support device or system, or to affect the safety or effectiveness of that device or system. Life support devices or systems are intended to be implanted in the human body, or to support and/or maintain and sustain and/or protect human life. If they fail, it is reasonable to assume that the health of the user or other persons may be endangered.

Table of Contents

CIPOS™ Control Integrated Power System.....4

Features.....4

Target Applications4

Description4

System Configuration4

Pin Configuration.....5

Internal Electrical Schematic.....5

Pin Assignment.....6

Pin Description6

 HIN(U,V,W) and LIN(U,V,W) (Low side and high side control pins, Pin 7 - 12)6

 VFO (Fault-output, Pin 14)7

 ITRIP (Over current detection function, Pin 15)7

 VDD, VSS (Low side control supply and reference, Pin 13, 16).....7

 VB(U,V,W) and VS(U,V,W) (High side supplies, Pin 1 - 6)7

 NW, NV, NU (Low side emitter, Pin 17 - 19)7

 W, V, U (High side emitter and low side collector, Pin 20 - 22).....7

 P (Positive bus input voltage, Pin 23)7

Absolute Maximum Ratings.....8

Module Section8

Inverter Section.....8

Control Section8

Recommended Operation Conditions9

Static Parameters.....10

Dynamic Parameters11

Bootstrap Parameters11

Mechanical Characteristics and Ratings.....12

Circuit of a Typical Application13

Switching Times Definition.....13

Electrical characteristic.....14

Package Outline.....15

CIPOS™

Control Integrated Power System

Dual In-Line Intelligent Power Module

3Φ-bridge 600V / 20A



Features

- Fully isolated Dual In-Line molded module
- Infineon reverse conducting IGBTs with monolithic body diode
- Rugged SOI gate driver technology with stability against transient and negative voltage
- Allowable negative VS potential up to -11V for signal transmission at VBS=15V
- Integrated bootstrap functionality
- Over current shutdown
- Under-voltage lockout at all channels
- Low side emitter pins accessible for all phase current monitoring (open emitter)
- Cross-conduction prevention
- All of 6 switches turn off during protection
- Lead-free terminal plating; RoHS compliant

Target Applications

- Dish washers
- Refrigerators
- Washing machines
- Air-conditioners
- Fans
- Low power motor drives

Description

The CIPOS™ module family offers the chance for integrating various power and control components to increase reliability, optimize PCB size and system costs.

It is designed to control three phase AC motors and permanent magnet motors in variable speed drives for applications like air conditioning, refrigerator and washing machine. The package concept is specially adapted to power applications, which need good thermal conduction and electrical isolation, but also EMI-save control and overload protection. The features of Infineon reverse conducting IGBT are combined with an optimized SOI gate driver for excellent electrical performance.

System Configuration

- 3 half bridges with reverse conducting IGBT
- 3Φ SOI gate driver
- Pin-to-heatsink creepage distance typ. 1.6mm

Pin Configuration

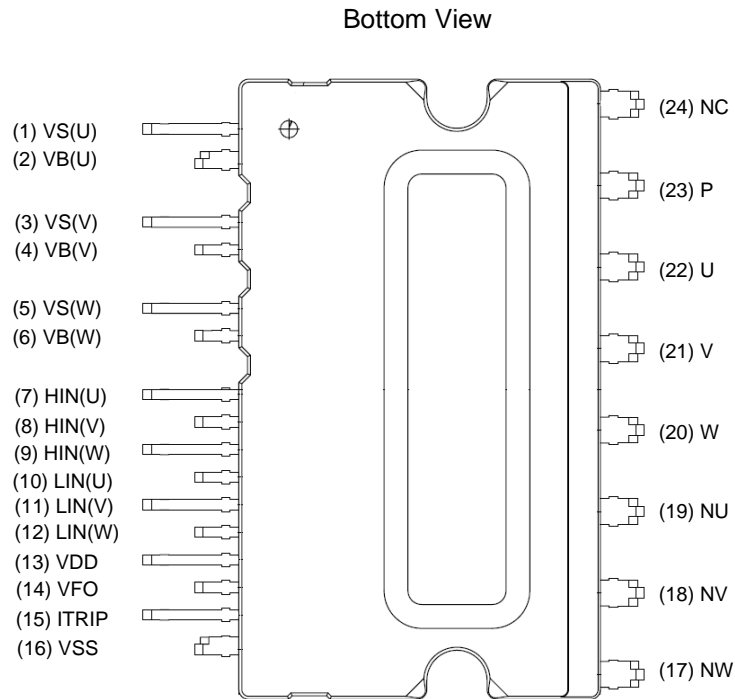

Figure 1: Pin configuration

Internal Electrical Schematic

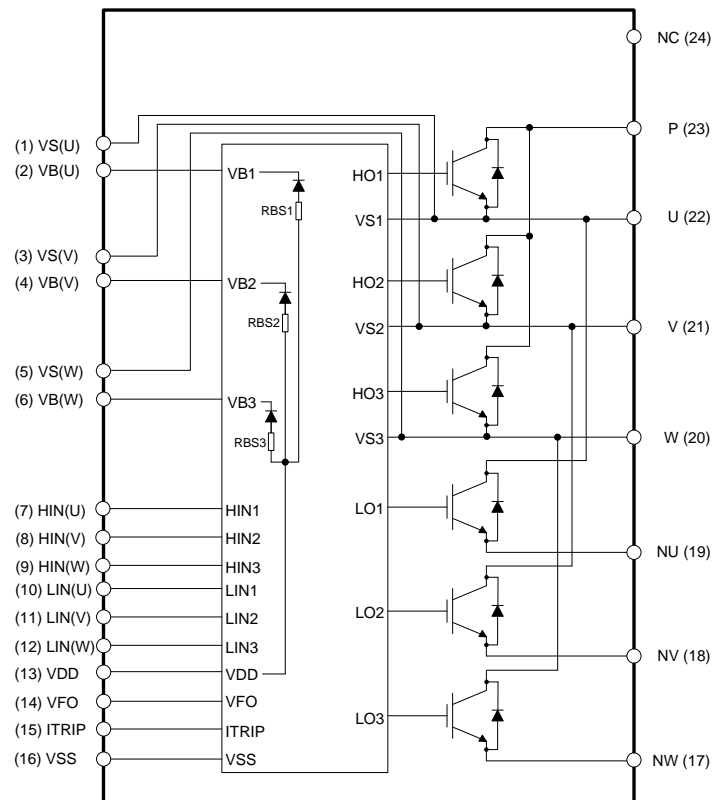

Figure 2: Internal schematic

Pin Assignment

Pin Number	Pin Name	Pin Description
1	VS(U)	U-phase high side floating IC supply offset voltage
2	VB(U)	U-phase high side floating IC supply voltage
3	VS(V)	V-phase high side floating IC supply offset voltage
4	VB(V)	V-phase high side floating IC supply voltage
5	VS(W)	W-phase high side floating IC supply offset voltage
6	VB(W)	W-phase high side floating IC supply voltage
7	HIN(U)	U-phase high side gate driver input
8	HIN(V)	V-phase high side gate driver input
9	HIN(W)	W-phase high side gate driver input
10	LIN(U)	U-phase low side gate driver input
11	LIN(V)	V-phase low side gate driver input
12	LIN(W)	W-phase low side gate driver input
13	VDD	Low side control supply
14	VFO	Fault output
15	ITRIP	Over current shutdown input
16	VSS	Low side control negative supply
17	NW	W-phase low side emitter
18	NV	V-phase low side emitter
19	NU	U-phase low side emitter
20	W	Motor W-phase output
21	V	Motor V-phase output
22	U	Motor U-phase output
23	P	Positive bus input voltage
24	NC	No Connection

Pin Description

HIN(U,V,W) and LIN(U,V,W) (Low side and high side control pins, Pin 7 - 12)

These pins are positive logic and they are responsible for the control of the integrated IGBT. The Schmitt-trigger input threshold of them are such to guarantee LSTTL and CMOS compatibility down to 3.3V controller outputs. Pull-down resistor of about 5kΩ is internally provided to pre-bias inputs during supply start-up and a zener clamp is provided for pin protection purposes. Input schmitt-trigger and noise filter provide beneficial noise rejection to short input pulses.

The noise filter suppresses control pulses which are below the filter time t_{FILIN} . The filter acts according to Figure 4.

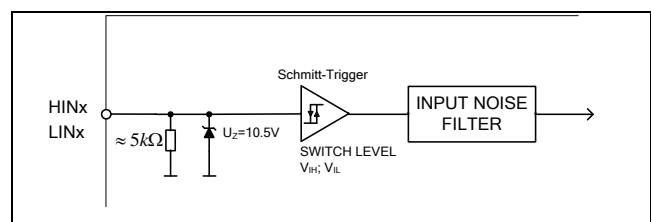

Figure 3: Input pin structure

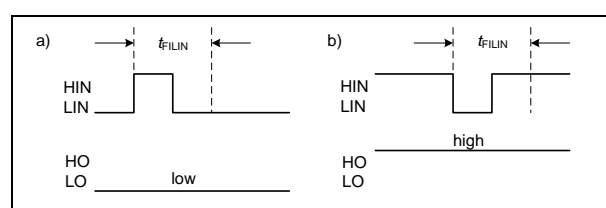

Figure 4: Input filter timing diagram

It is recommended for proper work of CIPOS™ not to provide input pulse-width lower than 1 μ s.

The integrated gate drive provides additionally a shoot through prevention capability which avoids the simultaneous on-state of two gate drivers of the same leg (i.e. HO1 and LO1, HO2 and LO2, HO3 and LO3). When two inputs of a same leg are activated, only former activated one is activated so that the leg is kept steadily in a safe state.

A minimum deadtime insertion of typ 380ns is also provided by driver IC, in order to reduce cross-conduction of the external power switches.

VFO (Fault-output, Pin 14)

The VFO pin indicates a module failure in case of under voltage at pin VDD or in case of triggered over current detection at ITRIP.

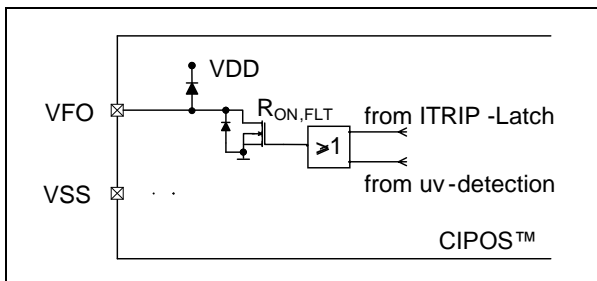

Figure 5: Internal circuit at pin VFO

ITRIP (Over current detection function, Pin 15)

CIPOS™ provides an over current detection function by connecting the ITRIP input with the motor current feedback. The ITRIP comparator threshold (typ 0.47V) is referenced to VSS ground. A input noise filter (typ: $t_{TRIPMIN} = 530ns$) prevents the driver to detect false over-current events.

Over current detection generates a shut down of all outputs of the gate driver after the shutdown propagation delay of typically 1000ns.

The fault-clear time is set to typical 65 μ s.

VDD, VSS (Low side control supply and reference, Pin 13, 16)

VDD is the low side supply and it provides power both to input logic and to low side output power stage. Input logic is referenced to VSS ground.

The under-voltage circuit enables the device to operate at power on when a supply voltage of at least a typical voltage of $V_{DDUV+} = 12.1V$ is present.

The IC shuts down all the gate drivers power outputs, when the VDD supply voltage is below $V_{DDUV-} = 10.4V$. This prevents the external power switches from critically low gate voltage levels during on-state and therefore from excessive power dissipation.

VB(U,V,W) and VS(U,V,W) (High side supplies, Pin 1 - 6)

VB to VS is the high side supply voltage. The high side circuit can float with respect to VSS following the external high side power device emitter voltage.

Due to the low power consumption, the floating driver stage is supplied by integrated bootstrap circuit.

The under-voltage detection operates with a rising supply threshold of typical $V_{BSUV+} = 12.1V$ and a falling threshold of $V_{BSUV-} = 10.4V$.

VS(U,V,W) provide a high robustness against negative voltage in respect of VSS of -50V transiently. This ensures very stable designs even under rough conditions.

NW, NV, NU (Low side emitter, Pin 17 - 19)

The low side emitters are available for current measurements of each phase leg. It is recommended to keep the connection to pin VSS as short as possible in order to avoid unnecessary inductive voltage drops.

W, V, U (High side emitter and low side collector, Pin 20 - 22)

These pins are motor U, V, W input pins

P (Positive bus input voltage, Pin 23)

The high side IGBT are connected to the bus voltage. It is noted that the bus voltage does not exceed 450 V.

Absolute Maximum Ratings

($V_{DD} = 15V$ and $T_C = 25^\circ C$, if not stated otherwise)

Module Section

Description	Condition	Symbol	Value		Unit
			min	max	
Storage temperature range		T_{stg}	-40	125	$^\circ C$
Insulation test voltage	RMS, $f=60Hz$, $t = 1min$	V_{ISOL}	2000	-	V
Operating case temperature range	Refer to Figure 6	T_C	-40	100	$^\circ C$

Inverter Section

Description	Condition	Symbol	Value		Unit
			min	max	
Max. blocking voltage	$I_C=250\mu A$	V_{CES}	600	-	V
DC link supply voltage of P-N	Applied between P-N	V_{PN}	-	450	V
DC link supply voltage (surge) of P-N	Applied between P-N	$V_{PN(surge)}$	-	500	V
Output current	$T_C = 25^\circ C, T_J < 150^\circ C$ $T_C = 80^\circ C, T_J < 150^\circ C$	I_C	-20 -15	20 15	A
Maximum peak output current	less than 1ms	I_C	-45	45	A
Short circuit withstand time ¹	$V_{DC} \leq 400V, T_J = 150^\circ C$	t_{SC}	-	5	μs
Power dissipation per IGBT		P_{tot}	-	33	W
Operating junction temperature range		T_J	-40	150	$^\circ C$
Single IGBT thermal resistance, junction-case		R_{thJC}	-	3.84	K/W

Control Section

Description	Condition	Symbol	Value		Unit
			min	max	
Module supply voltage		V_{DD}	-1	20	V
High side floating supply voltage (VB vs. VS)		V_{BS}	-1	20	V
Input voltage	LIN, HIN, ITRIP	V_{IN} V_{ITRIP}	-1 -1	10 10	V
Switching frequency		f_{PWM}	-	20	kHz

¹ Allowed number of short circuits: <1000; time between short circuits: >1s.

Recommended Operation Conditions

All voltages are absolute voltages referenced to V_{SS} -potential unless otherwise specified.

Description	Symbol	Value			Unit
		min	typ	max	
DC link supply voltage of P-N	V_{PN}	0	-	400	V
High side floating supply voltage (V_B vs. V_S)	V_{BS}	13.5	-	18.5	V
Low side supply voltage	V_{DD}	14.0	16	18.5	V
Control supply variation	ΔV_{BS} , ΔV_{DD}	-1	-	1	V/ μ s
Logic input voltages LIN,HIN,ITRIP	V_{IN} V_{ITRIP}	0	-	5	V
Between V_{SS} - N (including surge)	V_{SS}	-5	-	5	V

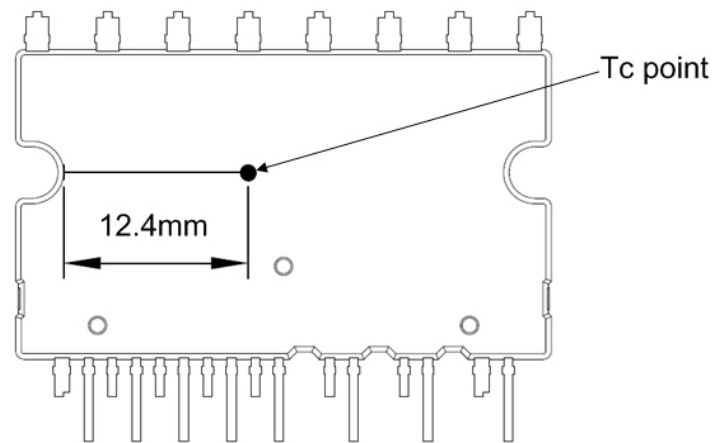

Figure 6: T_C measurement point

Static Parameters

(V_{DD} = 15V and T_C = 25°C, if not stated otherwise)

Description	Condition	Symbol	Value			Unit
			min	typ	max	
Collector-Emitter saturation voltage	I _{out} = 15A T _J = 25°C 150°C	V _{CE(sat)}	- -	1.6 1.8	2.0 -	V
Emitter-Collector forward voltage	I _{out} = -15A T _J = 25°C 150°C	V _F	- -	1.75 1.8	2.2	V
Collector-Emitter leakage current	V _{CE} = 600V	I _{CES}	-	-	1	mA
Logic "1" input voltage (LIN,HIN)		V _{IH}	-	2.1	2.5	V
Logic "0" input voltage (LIN,HIN)		V _{IL}	0.7	0.9	-	V
ITRIP positive going threshold		V _{IT,TH+}	400	470	540	mV
ITRIP input hysteresis		V _{IT,HYS}	40	70	-	mV
V _{DD} and V _{BS} supply under voltage positive going threshold		V _{DDUV+} V _{BSUV+}	10.8	12.1	13.0	V
V _{DD} and V _{BS} supply under voltage negative going threshold		V _{DDUV-} V _{BSUV-}	9.5	10.4	11.2	V
V _{DD} and V _{BS} supply under voltage lockout hysteresis		V _{DDUVH} V _{BSUVH}	1.0	1.7	-	V
Input clamp voltage (HIN, LIN, ITRIP)	I _{in} =4mA	V _{INCLAMP}	9.0	10.1	12.5	V
Quiescent V _{Bx} supply current (V _{Bx} only)	H _{IN} = 0V	I _{QBS}	-	300	500	μA
Quiescent VDD supply current (VDD only)	L _{IN} = 0V, H _{INX} =5V	I _{QDD}	-	370	900	μA
Input bias current	V _{IN} = 5V	I _{IN+}	-	1	1.5	mA
Input bias current	V _{IN} = 0V	I _{IN-}	-	2	-	μA
ITRIP input bias current	V _{ITRIP} = 5V	I _{ITRIP+}	-	65	150	μA
VFO input bias current	VFO = 5V, V _{ITRIP} = 0V	I _{FO}	-	2	-	nA
VFO output voltage	I _{FO} = 10mA, V _{ITRIP} = 1V	V _{FO}	-	0.5	-	V

Dynamic Parameters

($V_{DD} = 15V$ and $T_C = 25^\circ C$, if not stated otherwise)

Description	Condition	Symbol	Value			Unit
			min	typ	max	
Turn-on propagation delay time	$V_{LIN,HIN} = 5V; I_{out} = 15A,$ $V_{DC} = 300V$	t_{on}	-	650	-	ns
Turn-on rise time		t_r	-	45	-	ns
Turn-on switching time		$t_{c(on)}$		150		ns
Reverse recovery time		t_{rr}		200		ns
Turn-off propagation delay time	$V_{LIN,HIN} = 0V; I_{out} = 15A,$ $V_{DC} = 300V$	t_{off}	-	970	-	ns
Turn-off fall time		t_f	-	130	-	ns
Turn-off switching time		$t_{c(off)}$		200		ns
Short circuit propagation delay time	From $V_{IT,TH+}$ to 10% I_{SC}	t_{SCP}	-	1250	-	ns
Input filter time ITRIP	$V_{ITRIP} = 1V$	$t_{ITRIPmin}$		530		ns
Input filter time at LIN, HIN for turn on and off	$V_{LIN,HIN} = 0V \& 5V$	t_{FILIN}		290	-	ns
Fault clear time after ITRIP-fault	$V_{ITRIP} = 1V$	t_{FLTCLR}	40	65	200	μs
Deadtime between low side and high side		DT_{PWM}	1.5	-	-	μs
Deadtime of gate drive circuit		DT_{IC}		380		ns
IGBT turn-on energy (includes reverse recovery of diode)	$V_{DC} = 300V, I_C = 15A,$ $T_J = 25^\circ C$ $150^\circ C$	E_{on}	-	400	-	μJ
			-	605	-	
IGBT turn-off energy	$V_{DC} = 300V, I_C = 15A,$ $T_J = 25^\circ C$ $150^\circ C$	E_{off}	-	430	-	μJ
			-	625	-	
Diode recovery energy	$V_{DC} = 300V, I_C = 15A,$ $T_J = 25^\circ C$ $150^\circ C$	E_{rec}	-	95	-	μJ
			-	225	-	

Bootstrap Parameters

($T_C = 25^\circ C$, if not stated otherwise)

Description	Condition	Symbol	Value			Unit
			min	typ	max	
Repetitive peak reverse voltage		V_{RRM}	600			V
Bootstrap resistance of U-phase ¹	$VS2$ or $VS3=300V, T_J=25^\circ C$ $VS2$ and $VS3=0V, T_J=25^\circ C$ $VS2$ or $VS3=300V, T_J=125^\circ C$ $VS2$ and $VS3=0V, T_J=125^\circ C$	R_{BS1}		35		Ω
				40		
				50		
				65		
Reverse recovery time	$I_F=0.6A, di/dt=80A/\mu s$	t_{rr_BS}		50		ns
Forward voltage drop	$I_F=20mA, VS2$ and $VS3=0V$	V_{F_BS}		2.6		V

¹ R_{BS2} and R_{BS3} have same values to R_{BS1} .

Mechanical Characteristics and Ratings

Description	Condition	Value			Unit
		min	typ	max	
Mounting torque	M3 screw and washer	0.59	0.69	0.78	Nm
Flatness	Refer to Figure 7	-50	-	100	µm
Weight		-	6.15	-	g

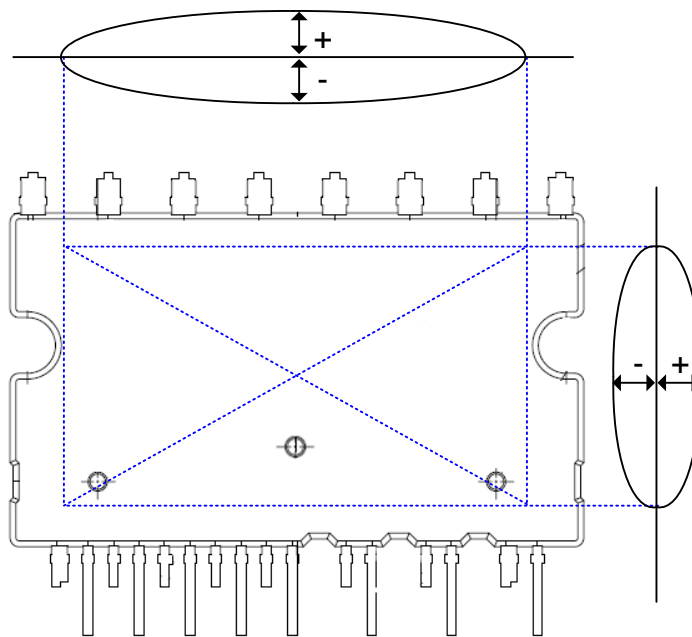

Figure 7: Flatness measurement position

Circuit of a Typical Application

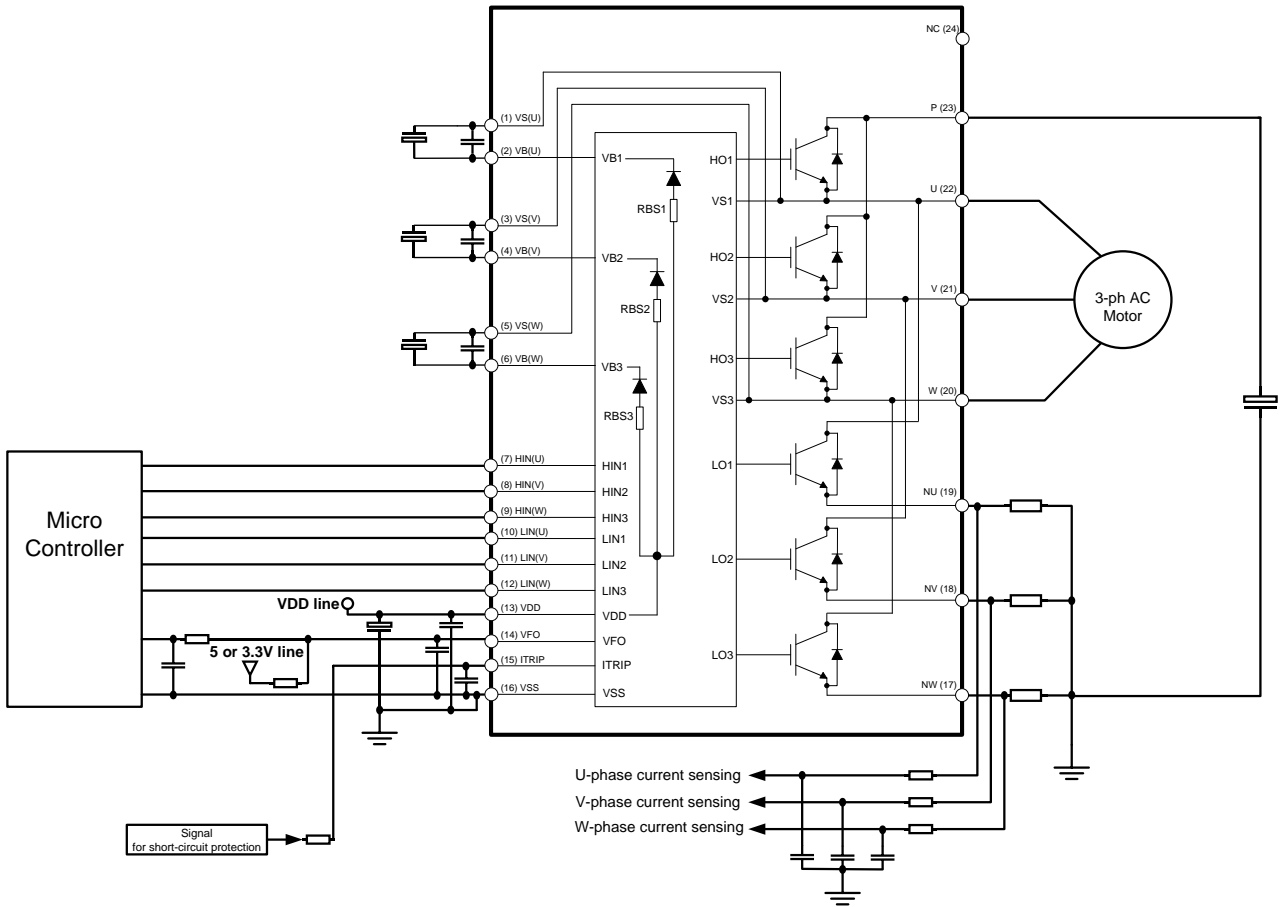

Figure 8: Application circuit

Switching Times Definition

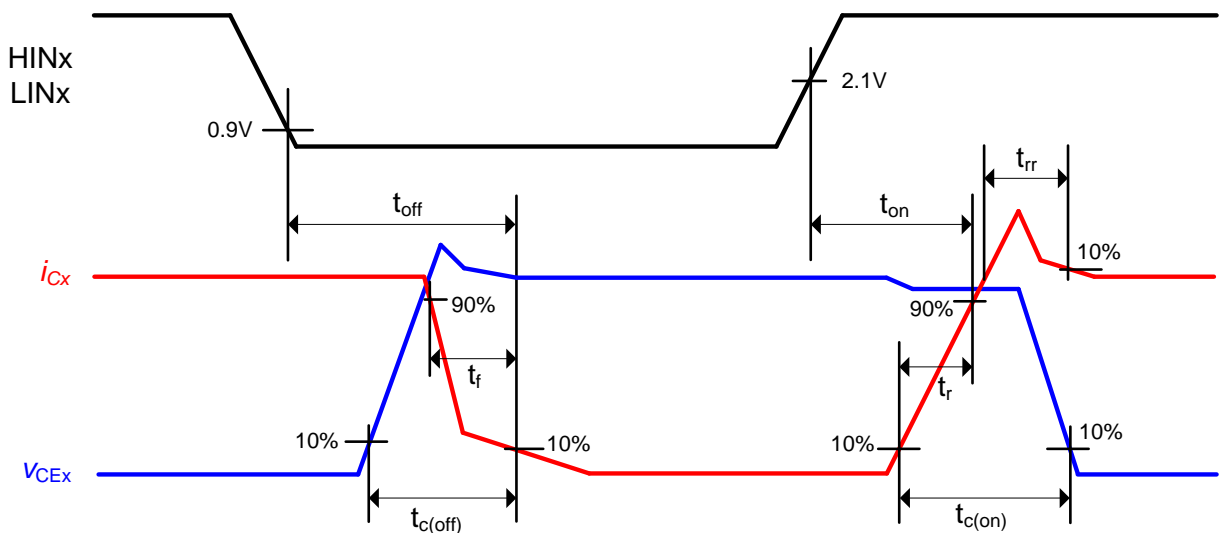
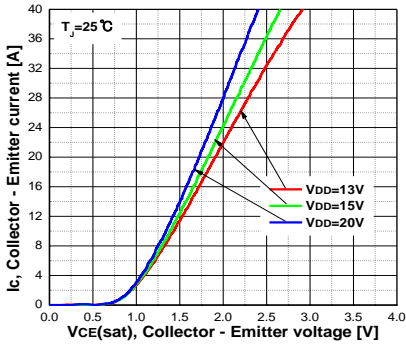
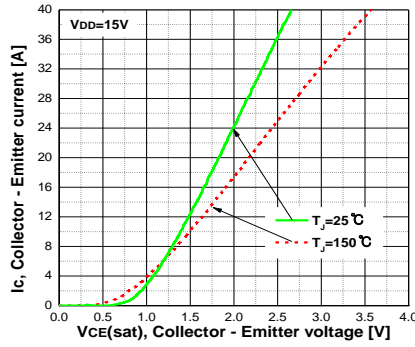

Figure 9: Switching times definition

Electrical characteristic



Typ. Collector – Emitter saturation voltage



Typ. Collector – Emitter saturation voltage

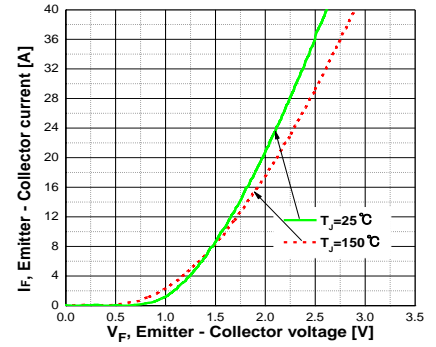

Typ. Emitter – Collector forward voltage

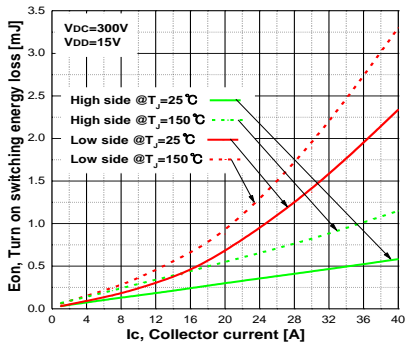

Typ. Turn on switching energy loss

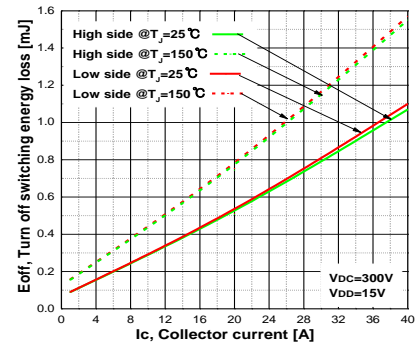

Typ. Turn off switching energy loss

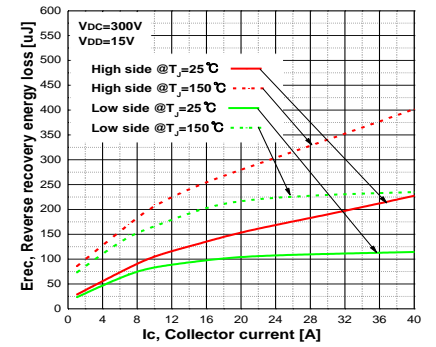

Typ. Reverse recovery energy loss

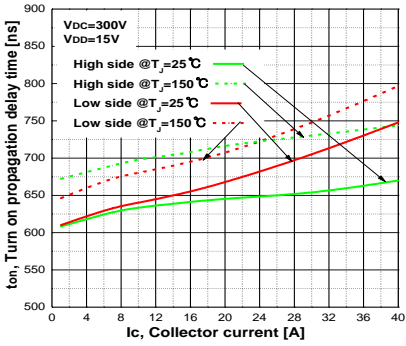

Typ. Turn on propagation delay time

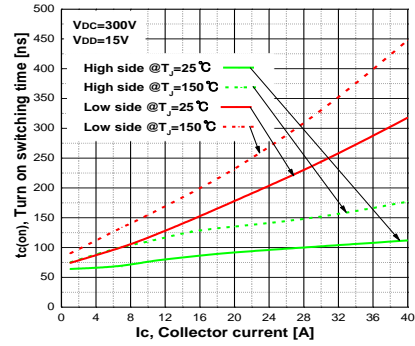

Typ. Turn on switching time

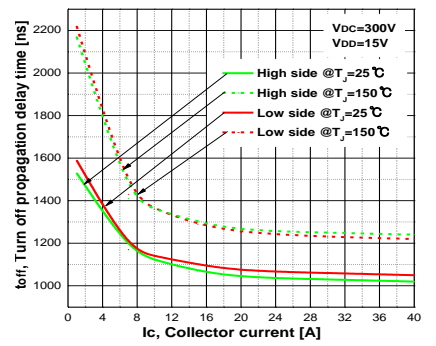

Typ. Turn off propagation delay time

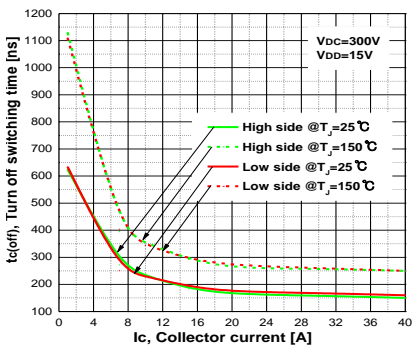

Typ. Turn off switching time

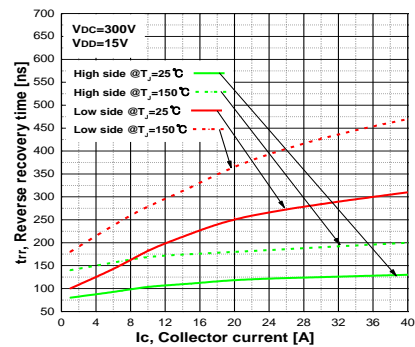

Typ. Reverse recovery time

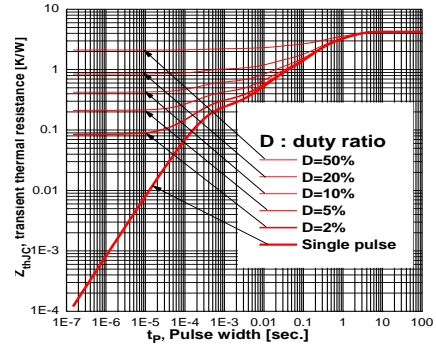

IGBT transient thermal resistance at all six IGBTs operation

Package Outline

