

Applications

- Brushed Motor drive applications
- BLDC Motor drive applications
- Battery powered circuits
- Half-bridge and full-bridge topologies
- Synchronous rectifier applications
- Resonant mode power supplies
- OR-ing and redundant power switches
- DC/DC and AC/DC converters
- DC/AC Inverters

DirectFET® Power MOSFET

V_{DSS}	40V
R_{DS(on)} typ. max.	1.1mΩ
	1.4mΩ
I_D (Silicon Limited)	198AⓄ
I_D (Package Limited)	90A

Benefits

- Improved Gate, Avalanche and Dynamic dV/dt Ruggedness
- Fully Characterized Capacitance and Avalanche SOA
- Enhanced body diode dV/dt and dI/dt Capability
- RoHS Compliant Containing no Lead, no Bromide and no Halogen

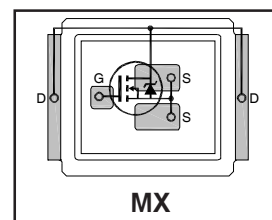

Base part number	Package Type	Standard Pack		Complete Part Number
		Form	Quantity	
IRF7946TRPbF	DirectFET MX	Tape and Reel	4800	IRF7946TRPbF

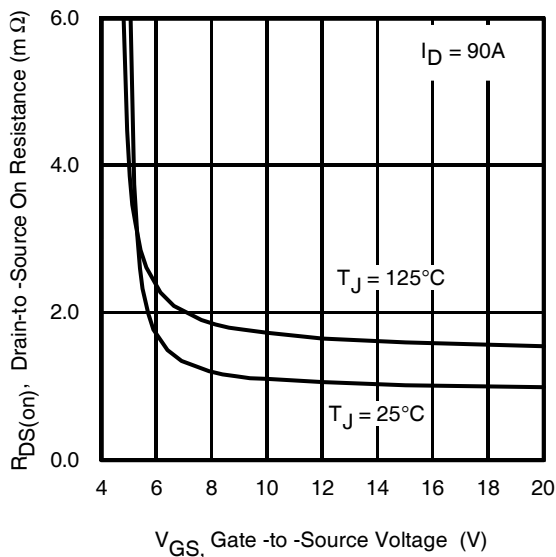

Fig 1. Typical On-Resistance vs. Gate Voltage

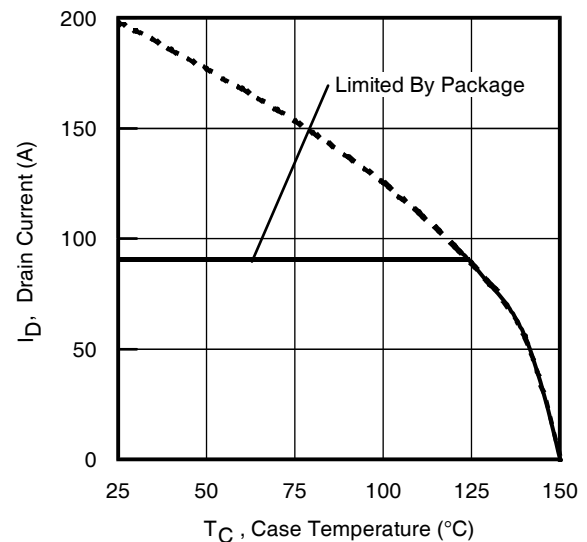

Fig 2. Maximum Drain Current vs. Case Temperature

Absolute Maximum Ratings

Symbol	Parameter	Max.	Units
$I_D @ T_C = 25^\circ\text{C}$	Continuous Drain Current, $V_{GS} @ 10\text{V}$ (Silicon Limited)	198 ^①	A
$I_D @ T_C = 100^\circ\text{C}$	Continuous Drain Current, $V_{GS} @ 10\text{V}$ (Silicon Limited)	125 ^①	
I_{DM}	Pulsed Drain Current ^②	793	
$P_D @ T_C = 25^\circ\text{C}$	Maximum Power Dissipation	96	W
	Linear Derating Factor	0.77	W/ $^\circ\text{C}$
V_{GS}	Gate-to-Source Voltage	± 20	V
T_J	Operating Junction and	-55 to + 150	$^\circ\text{C}$
T_{STG}	Storage Temperature Range		

Avalanche Characteristics

E_{AS} (Thermally limited)	Single Pulse Avalanche Energy ^③	85	mJ
E_{AS} (Thermally limited)	Single Pulse Avalanche Energy ^④	200	
I_{AR}	Avalanche Current ^②	See Fig. 14, 15, 22a, 22b	A
E_{AR}	Repetitive Avalanche Energy ^②		mJ

Thermal Resistance

Symbol	Parameter	Typ.	Max.	Units
$R_{\theta JA}$	Junction-to-Ambient ^①	—	45	$^\circ\text{C}/\text{W}$
$R_{\theta JA}$	Junction-to-Ambient ^②	12.5	—	
$R_{\theta JA}$	Junction-to-Ambient ^③	20	—	
$R_{\theta JC}$	Junction-to-Case ^{④⑤}	—	1.3	
$R_{\theta JA-PCB}$	Junction-to-PCB Mounted	1.0	—	

Static @ $T_J = 25^\circ\text{C}$ (unless otherwise specified)

Symbol	Parameter	Min.	Typ.	Max.	Units	Conditions
$V_{(BR)DSS}$	Drain-to-Source Breakdown Voltage	40	—	—	V	$V_{GS} = 0\text{V}$, $I_D = 250\mu\text{A}$
$\Delta V_{(BR)DSS}/\Delta T_J$	Breakdown Voltage Temp. Coefficient	—	0.03	—	V/ $^\circ\text{C}$	Reference to 25°C , $I_D = 1.0\text{mA}$ ^②
$R_{DS(on)}$	Static Drain-to-Source On-Resistance	—	1.1	1.4	$\text{m}\Omega$	$V_{GS} = 10\text{V}$, $I_D = 90\text{A}$ ^⑤
		—	1.7	—	$\text{m}\Omega$	$V_{GS} = 6.0\text{V}$, $I_D = 72\text{A}$ ^⑤
$V_{GS(th)}$	Gate Threshold Voltage	2.2	3.0	3.9	V	$V_{DS} = V_{GS}$, $I_D = 150\mu\text{A}$
I_{DSS}	Drain-to-Source Leakage Current	—	—	1.0	μA	$V_{DS} = 40\text{V}$, $V_{GS} = 0\text{V}$
		—	—	150	μA	$V_{DS} = 40\text{V}$, $V_{GS} = 0\text{V}$, $T_J = 125^\circ\text{C}$
I_{GSS}	Gate-to-Source Forward Leakage	—	—	100	nA	$V_{GS} = 20\text{V}$
	Gate-to-Source Reverse Leakage	—	—	-100	nA	$V_{GS} = -20\text{V}$
R_G	Internal Gate Resistance	—	0.67	—	Ω	

Notes:

- ^② Mounted on minimum footprint full size board with metalized back and with small clip heatsink.
- ^③ Used double sided cooling , mounting pad with large heatsink.
- ^④ T_C measured with thermocouple mounted to top (Drain) of part.

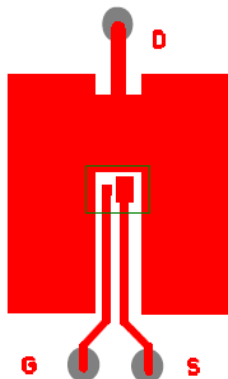

^① Surface mounted on 1 in. square Cu (still air).

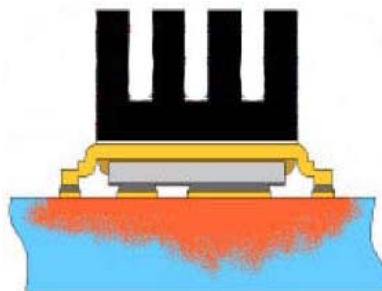

^② Mounted to a PCB with small clip heatsink (still air)

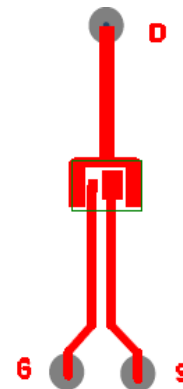

^③ Mounted on minimum footprint full size board with metalized back and with small clip heatsink (still air)

Dynamic @ T_J = 25°C (unless otherwise specified)

Symbol	Parameter	Min.	Typ.	Max.	Units	Conditions	
g _{fs}	Forward Transconductance	91	—	—	S	V _{DS} = 10V, I _D = 90A	
Q _g	Total Gate Charge	—	141	212	nC	I _D = 90A V _{DS} = 20V V _{GS} = 10V ⑤ I _D = 90A, V _{DS} = 0V, V _{GS} = 10V	
Q _{gs}	Gate-to-Source Charge	—	36	—			
Q _{gd}	Gate-to-Drain ("Miller") Charge	—	44	—			
Q _{sync}	Total Gate Charge Sync. (Q _g - Q _{gd})	—	97	—			
t _{d(on)}	Turn-On Delay Time	—	20	—			ns
t _r	Rise Time	—	49	—			
t _{d(off)}	Turn-Off Delay Time	—	54	—			
t _f	Fall Time	—	41	—			
C _{iss}	Input Capacitance	—	6852	—	pF	V _{GS} = 0V V _{DS} = 25V f = 1.0 MHz	
C _{oss}	Output Capacitance	—	1046	—			
C _{rss}	Reverse Transfer Capacitance	—	735	—			
C _{oss} eff. (ER)	Effective Output Capacitance (Energy Related)	—	1307	—			V _{GS} = 0V, V _{DS} = 0V to 32V ⑦
C _{oss} eff. (TR)	Effective Output Capacitance (Time Related)	—	1465	—			

Diode Characteristics

Symbol	Parameter	Min.	Typ.	Max.	Units	Conditions
I _S	Continuous Source Current (Body Diode)	—	—	96①	A	MOSFET symbol showing the integral reverse p-n junction diode.
I _{SM}	Pulsed Source Current (Body Diode) ②	—	—	793	A	
V _{SD}	Diode Forward Voltage	—	0.75	1.2	V	T _J = 25°C, I _S = 90A, V _{GS} = 0V ⑤
dv/dt	Peak Diode Recovery ④	—	1.6	—	V/ns	T _J = 175°C, I _S = 90A, V _{DS} = 40V
t _{rr}	Reverse Recovery Time	—	49	—	ns	T _J = 25°C V _R = 34V, T _J = 125°C I _F = 90A
Q _{rr}	Reverse Recovery Charge	—	74	—		
I _{RRM}	Reverse Recovery Current	—	2.6	—	A	T _J = 125°C

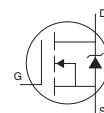

Notes:

- ① Calculated continuous current based on maximum allowable junction temperature. Package limit is 90A.
- ② Repetitive rating; pulse width limited by max. junction temperature.
- ③ Limited by T_{Jmax}, starting T_J = 25°C, L = 0.021mH
R_G = 50Ω, I_{AS} = 90A, V_{GS} = 10V.
- ④ I_{SD} ≤ 90A, di/dt ≤ 1135A/μs, V_{DD} ≤ V_{(BR)DSS}, T_J ≤ 150°C.

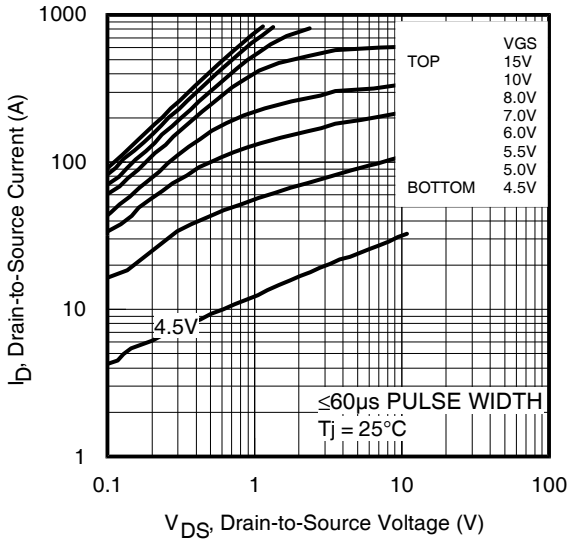
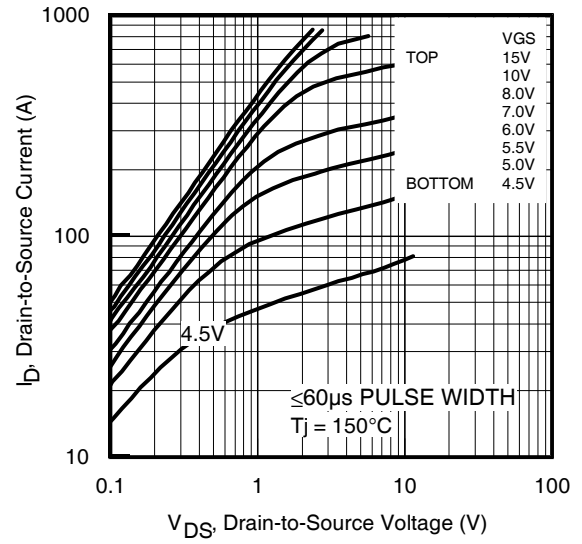
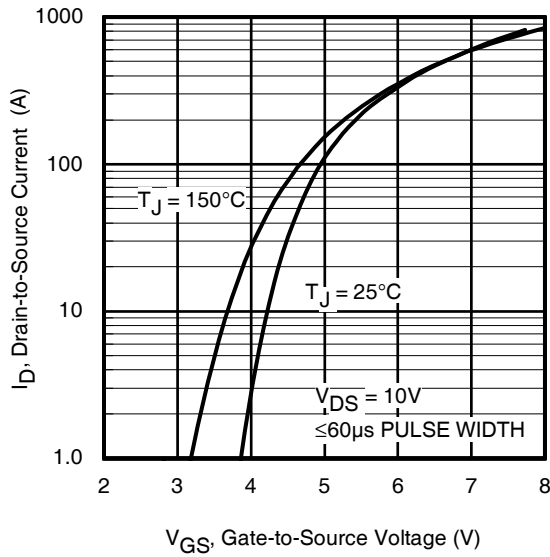
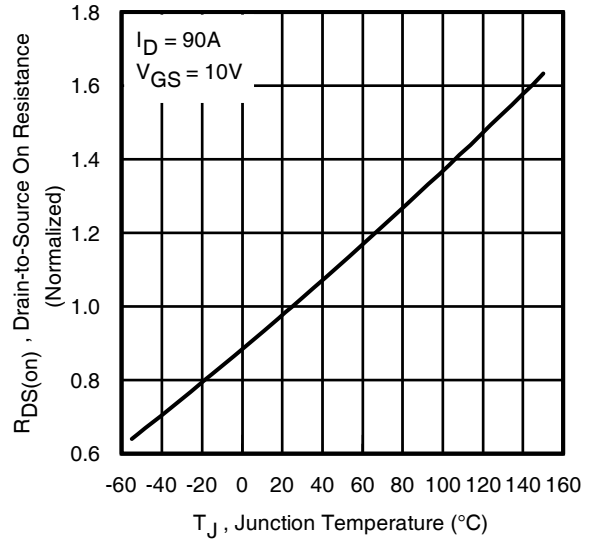
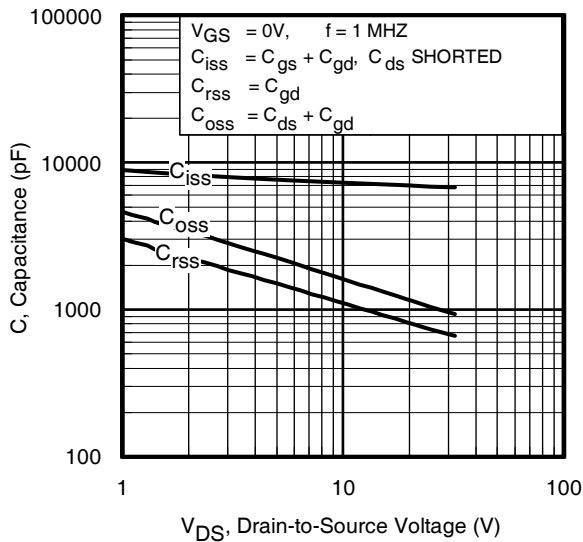
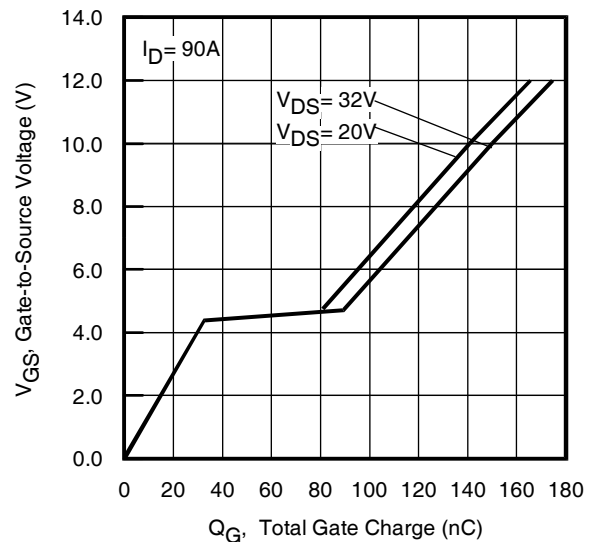
- ⑤ Pulse width ≤ 400μs; duty cycle ≤ 2%.
- ⑥ C_{oss} eff. (TR) is a fixed capacitance that gives the same charging time as C_{oss} while V_{DS} is rising from 0 to 80% V_{DSS}.
- ⑦ C_{oss} eff. (ER) is a fixed capacitance that gives the same energy as C_{oss} while V_{DS} is rising from 0 to 80% V_{DSS}.
- ⑧ When mounted on 1" square PCB (FR-4 or G-10 Material). For recommended footprint and soldering techniques refer to application note #AN-994.
- ⑨ R_θ is measured at T_J approximately 90°C.
- ⑩ Limited by T_{Jmax} starting T_J = 25°C, L = 1mH, R_G = 50Ω, I_{AS} = 20A, V_{GS} = 10V

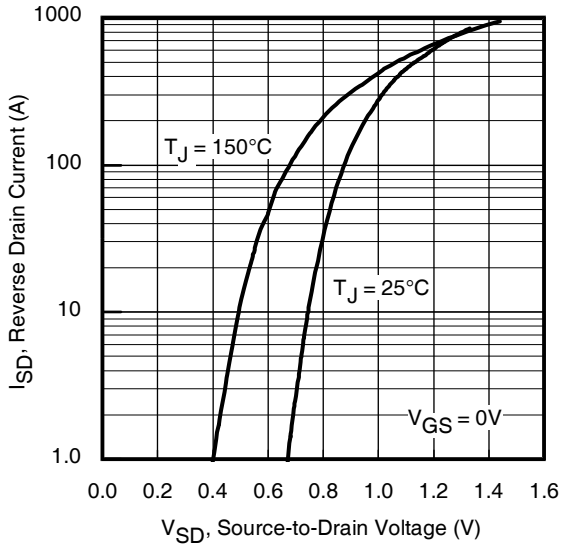
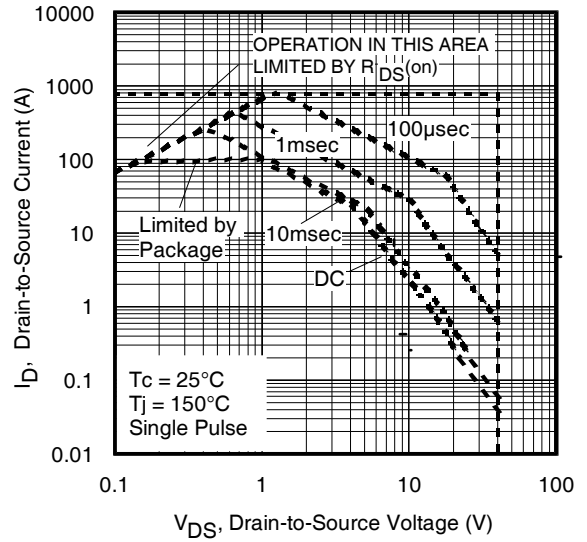
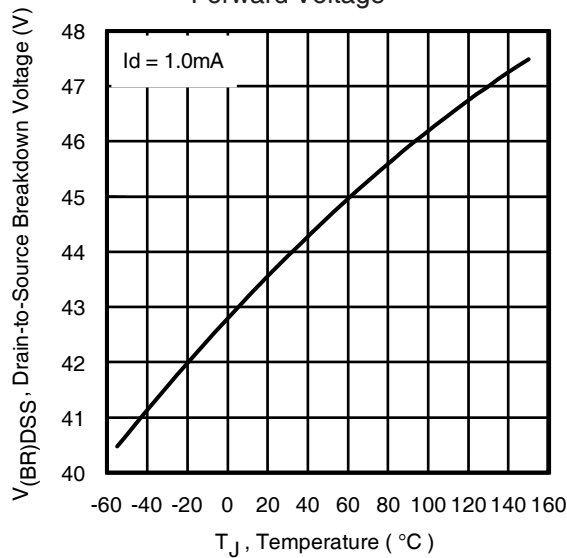
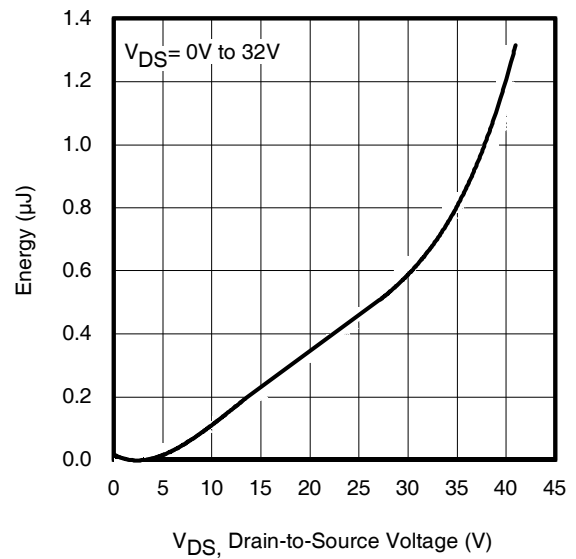
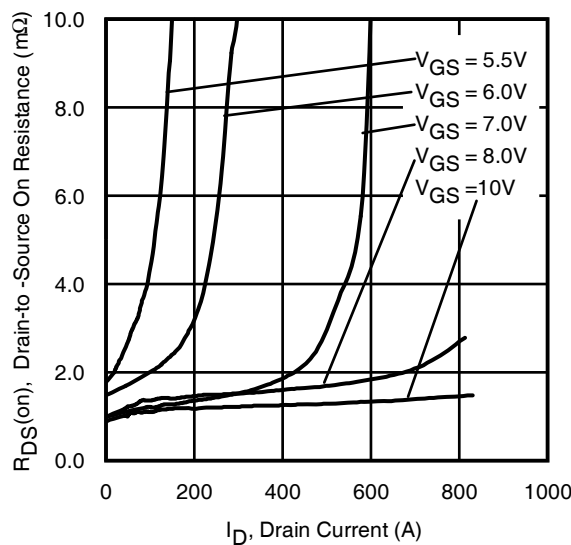
Fig 3. Typical Output Characteristics

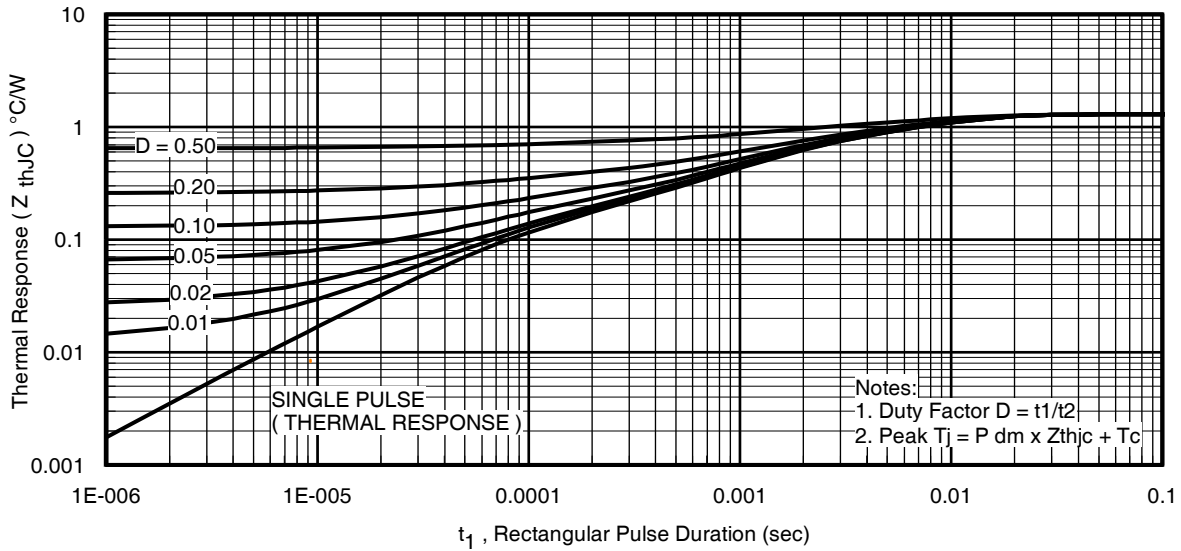
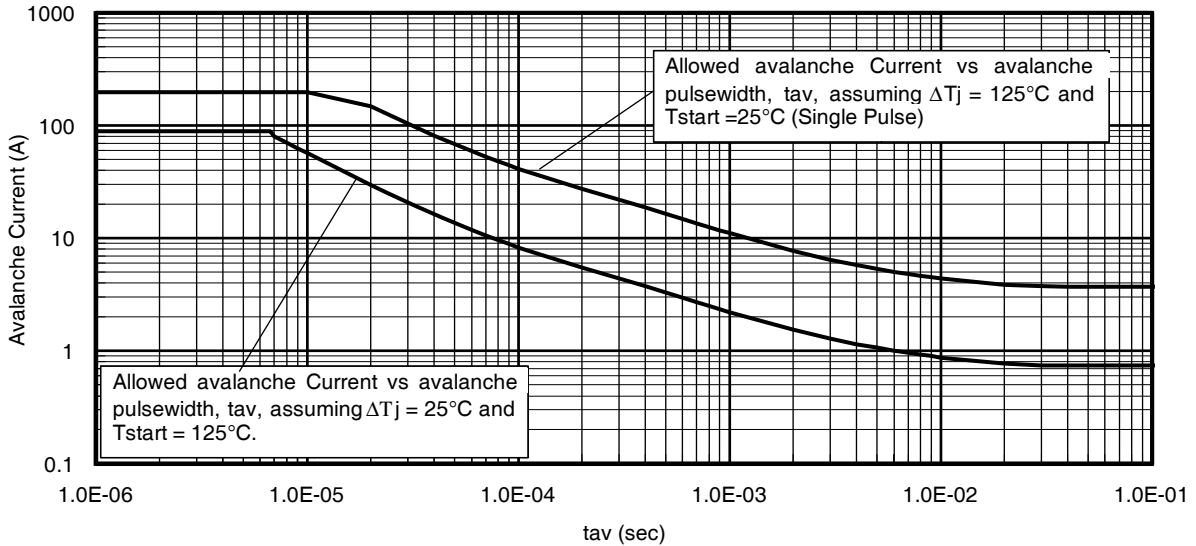
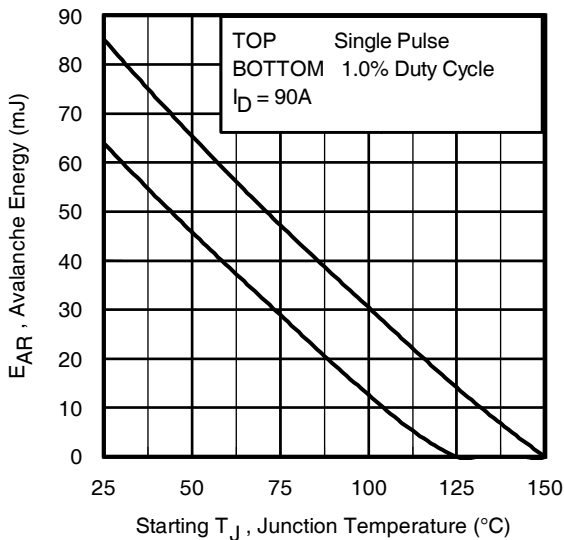
Fig 4. Typical Output Characteristics

Fig 5. Typical Transfer Characteristics

Fig 6. Normalized On-Resistance vs. Temperature

Fig 7. Typical Capacitance vs. Drain-to-Source Voltage

Fig 8. Typical Gate Charge vs. Gate-to-Source Voltage

Fig 9. Typical Source-Drain Diode Forward Voltage

Fig 10. Maximum Safe Operating Area

Fig 11. Drain-to-Source Breakdown Voltage

Fig 12. Typical C_{OSS} Stored Energy

Fig 13. Typical On-Resistance vs. Drain Current

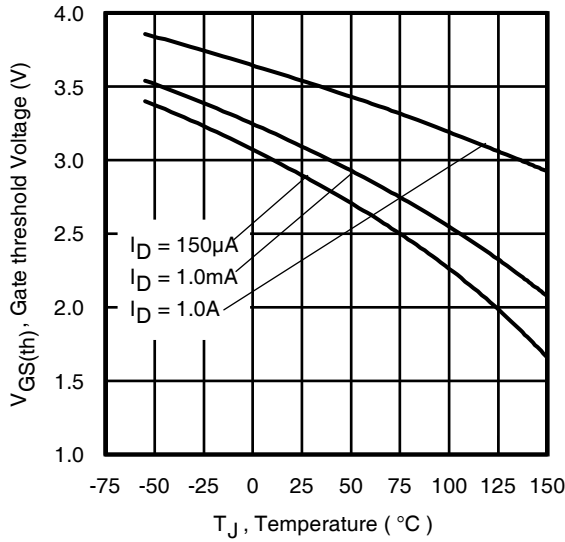
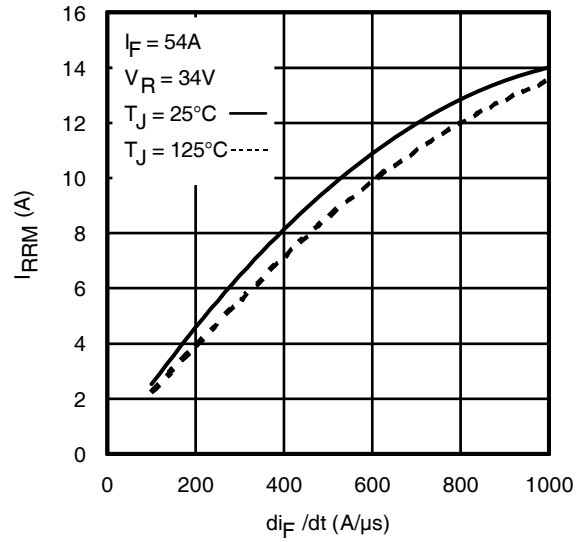
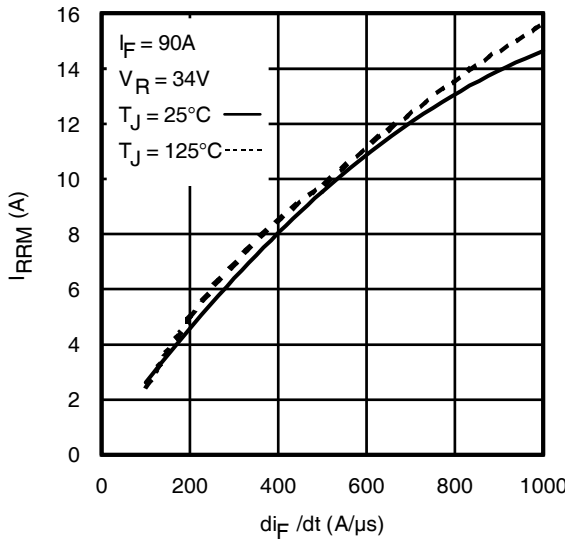
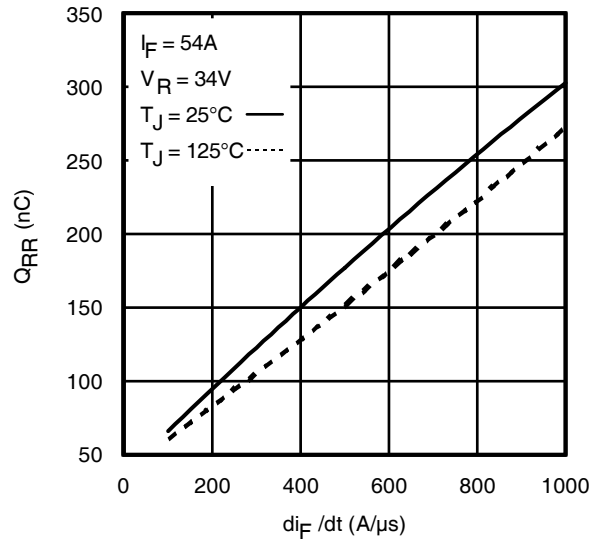
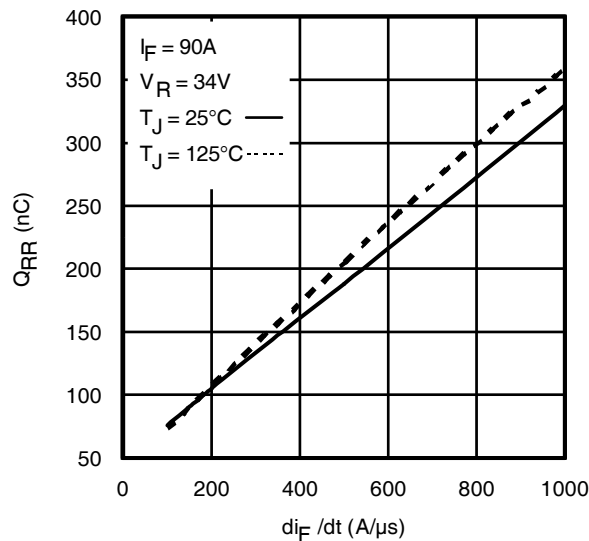

Fig 14. Maximum Effective Transient Thermal Impedance, Junction-to-Case

Fig 15. Typical Avalanche Current vs. Pulsewidth

Fig 16. Maximum Avalanche Energy vs. Temperature
**Notes on Repetitive Avalanche Curves , Figures 14, 15:
(For further info, see AN-1005 at www.irf.com)**

1. Avalanche failures assumption:
Purely a thermal phenomenon and failure occurs at a temperature far in excess of T_{jmax} . This is validated for every part type.
2. Safe operation in Avalanche is allowed as long as T_{jmax} is not exceeded.
3. Equation below based on circuit and waveforms shown in Figures 16a, 16b.
4. $P_{D(ave)}$ = Average power dissipation per single avalanche pulse.
5. BV = Rated breakdown voltage (1.3 factor accounts for voltage increase during avalanche).
6. I_{av} = Allowable avalanche current.
7. ΔT = Allowable rise in junction temperature, not to exceed T_{jmax} (assumed as 25°C in Figure 14, 15).
 t_{av} = Average time in avalanche.
 D = Duty cycle in avalanche = $t_{av} \cdot f$
 $Z_{thJC}(D, t_{av})$ = Transient thermal resistance, see Figures 13)

$$P_{D(ave)} = 1/2 (1.3 \cdot BV \cdot I_{av}) = \Delta T / Z_{thJC}$$

$$I_{av} = 2\Delta T / [1.3 \cdot BV \cdot Z_{th}]$$

$$E_{AS(AR)} = P_{D(ave)} \cdot t_{av}$$

Fig 17. Threshold Voltage vs. Temperature

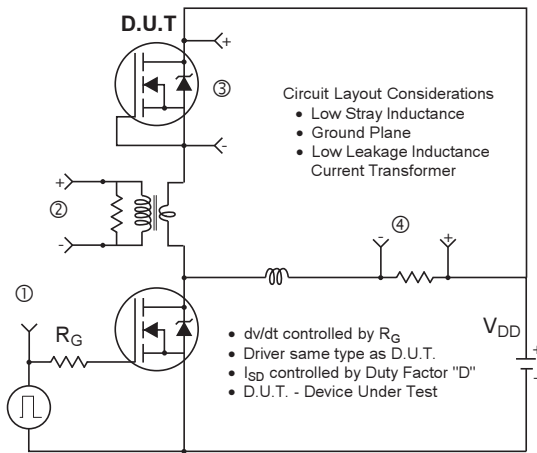
Fig. 18 - Typical Recovery Current vs. di_f/dt

Fig. 19 - Typical Recovery Current vs. di_f/dt

Fig. 20 - Typical Stored Charge vs. di_f/dt

Fig. 21 - Typical Stored Charge vs. di_f/dt



* $V_{GS} = 5V$ for Logic Level Devices

Fig 22. Peak Diode Recovery dv/dt Test Circuit for N-Channel HEXFET® Power MOSFETs

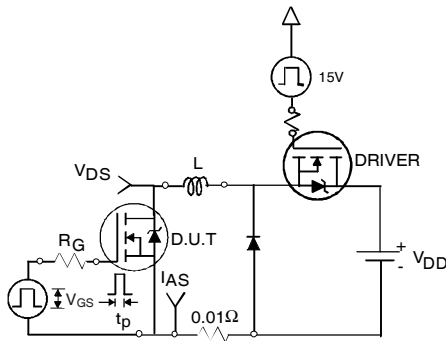

Fig 22a. Unclamped Inductive Test Circuit



Fig 22b. Unclamped Inductive Waveforms



Fig 23a. Switching Time Test Circuit



Fig 23b. Switching Time Waveforms



Fig 24a. Gate Charge Test Circuit

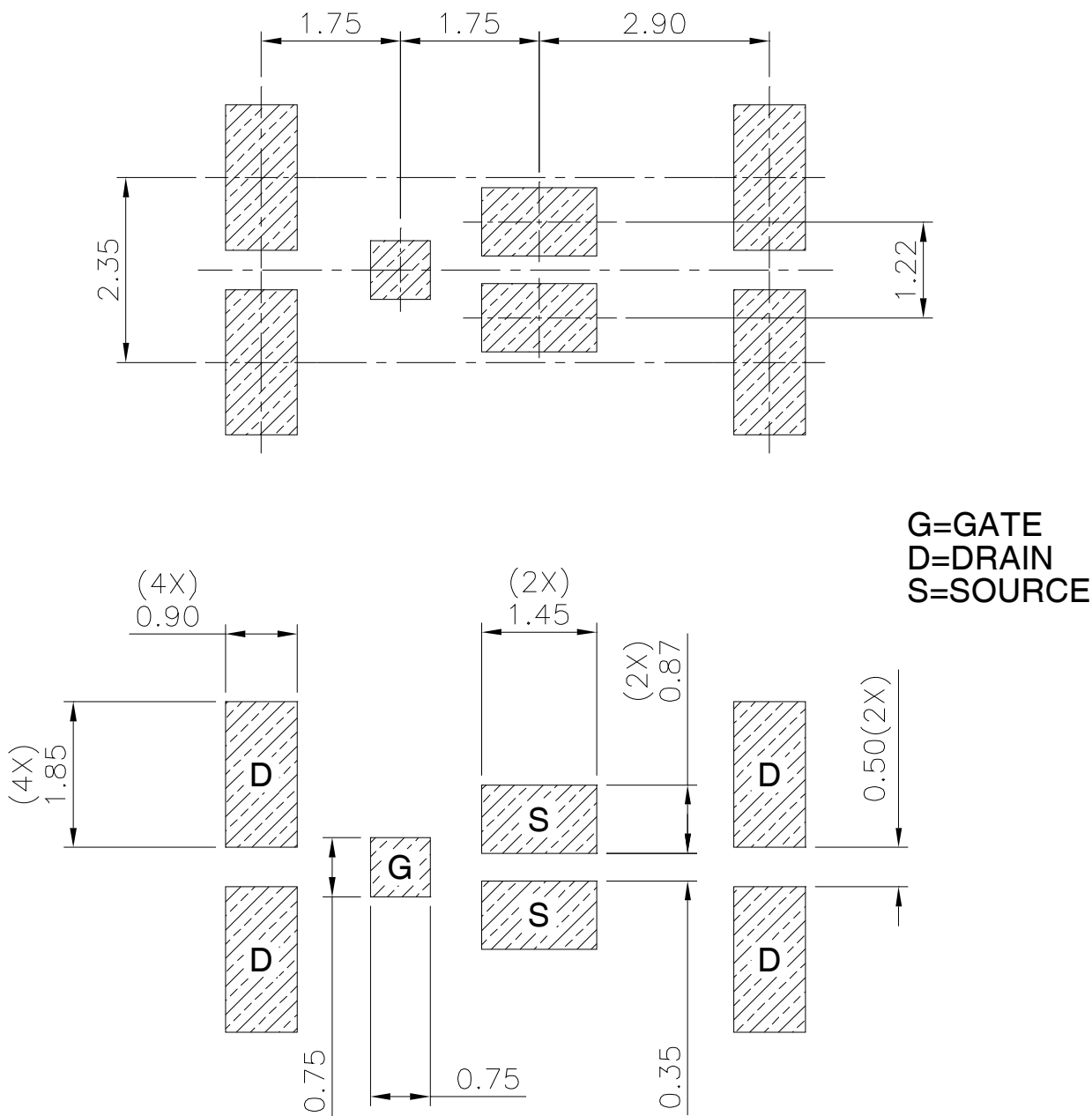

Fig 24b. Gate Charge Waveform

DirectFET® Board Footprint, MX Outline (Medium Size Can, X-Designation).

Please see DirectFET application note AN-1035 for all details regarding the assembly of DirectFET.

This includes all recommendations for stencil and substrate designs.



Note: For the most current drawing please refer to IR website at: <http://www.irf.com/package/>

DirectFET® Outline Dimension, MX Outline (Medium Size Can, X-Designation).

Please see DirectFET application note AN-1035 for all details regarding the assembly of DirectFET. This includes all recommendations for stencil and substrate designs.

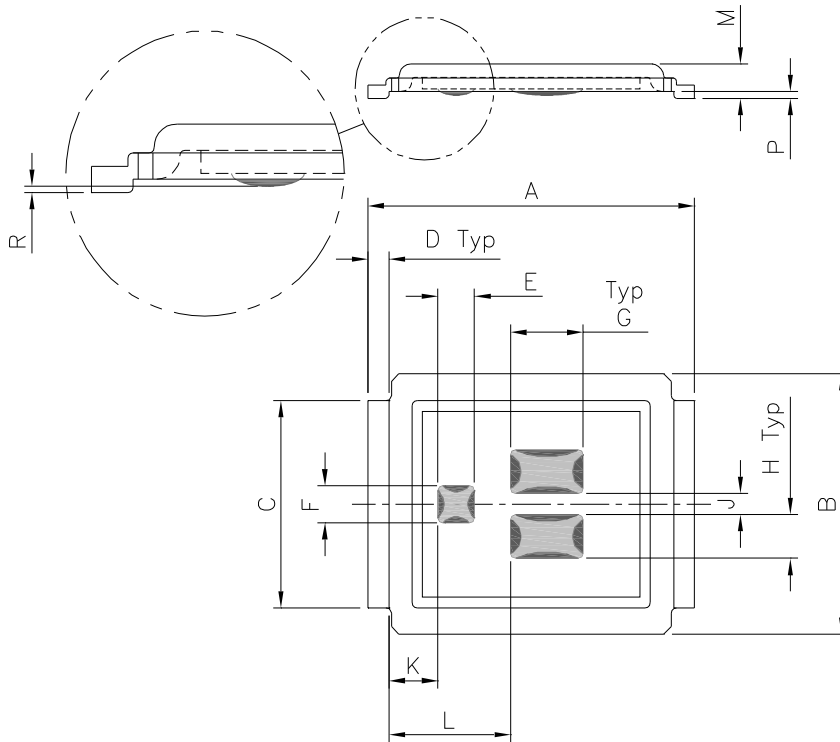

CODE	METRIC		IMPERIAL	
	MIN	MAX	MIN	MAX
A	6.25	6.35	0.246	0.250
B	4.80	5.05	0.189	0.199
C	3.85	3.95	0.152	0.156
D	0.35	0.45	0.014	0.018
E	0.68	0.72	0.027	0.028
F	0.68	0.72	0.027	0.028
G	1.38	1.42	0.054	0.056
H	0.80	0.84	0.031	0.033
J	0.38	0.42	0.015	0.017
K	0.88	1.02	0.035	0.040
L	2.28	2.42	0.090	0.095
M	0.59	0.70	0.023	0.028
R	0.03	0.08	0.001	0.003
P	0.08	0.17	0.003	0.007

Dimensions are shown in millimeters (inches)

DirectFET® Part Marking

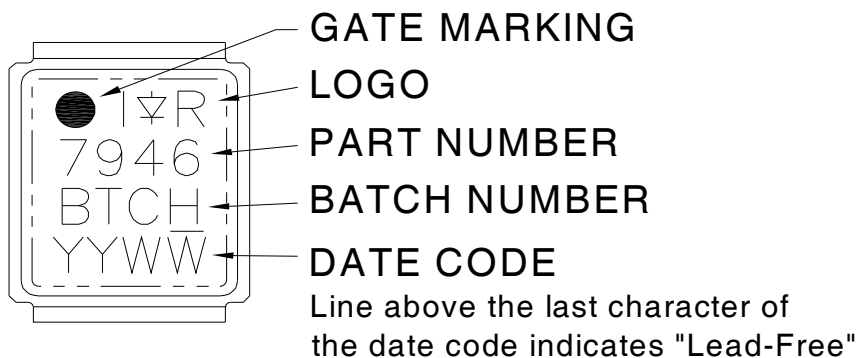

Note: For the most current drawing please refer to IR website at: <http://www.irf.com/package/>

Qualification information†

Qualification level	Consumer ^{††}	
	(per JEDEC JESD47F ^{†††} guidelines)	
Moisture Sensitivity Level	DFET 1.5	MSL1
		(per JEDEC J-STD-020D ^{†††})
RoHS compliant	Yes	

† Qualification standards can be found at International Rectifier’s web site: <http://www.irf.com/product-info/reliability/>

†† Higher qualification ratings may be available should the user have such requirements. Please contact your International Rectifier sales representative for further information: <http://www.irf.com/whoto-call/salesrep/>

††† Applicable version of JEDEC standard at the time of product release.

Revision History

Date	Comment
5/7/2014	<ul style="list-style-type: none"> • Updated data sheet based on corporate template. • Updated Qual level from "MSL3" to "MSL1" on page12. • Updated ordering information to reflect the End-Of-life (EOL) of the mini-reel option (EOL notice #264).
5/30/2014	<ul style="list-style-type: none"> • Remove IRF7946TR1PBF quantity= 1000 from ordering table on page1. • Remove continuous drain current package limit=90A from Absolute Maximum table-on page2
11/25/2014	<ul style="list-style-type: none"> • Updated $E_{AS(L=1mH)} = 200mJ$ on page 2 • Updated note 10 "Limited by T_{Jmax}, starting $T_J = 25^{\circ}C$, $L = 1mH$, $R_G = 50\Omega$, $I_{AS} = 20A$, $V_{GS} = 10V$". on page 3 • Updated $R_{\theta JA}$ from "60°C/W" to "45°C/W" on page 2