

MASW-006102-13610

HMIC™ Silicon PIN Diode Switch with Integrated Bias Network

V2

Features

- ◆ Broad Bandwidth 2 to 18 GHz
- ◆ Usable up to 26 GHz
- ◆ Integrated Bias Network
- ◆ Low Insertion Loss / High Isolation
- ◆ Rugged, Glass Encapsulated Construction
- ◆ Fully Monolithic
- ◆ RoHS Compliant

Description

The MASW-006102-13610 is a SP6T broadband switch with integrated bias network utilizing M/A-COM Technology Solutions HMIC™ (Heterolithic Microwave Integrated Circuit) process, US Patent 5,268,310. This wafer fabrication process allows the incorporation of silicon pedestals that form series and shunt diodes and vias by imbedding them in low loss, low dispersion glass. By using small spacing between elements, plus the combination of silicon and glass gives this HMIC device low loss and high isolation performance with exceptional repeatability through low millimeter frequencies. Large bond pads facilitate the use of low inductance ribbons or 1 mil wire while full backside gold metallization allows for die attachment using 80/20 - Au/Sn, 62/36/2 - Sn/Pb/Ag solders or electrically conductive silver epoxy.

Applications

The MASW-006102-13160 is a high performance switch which is suitable for use in multi-band ECM, radar, and instrumentation control circuits where high isolation to insertion loss ratios are required. With a standard +5V/-5V, TTL controlled PIN diode driver, 80nS switching speeds can be achieved.

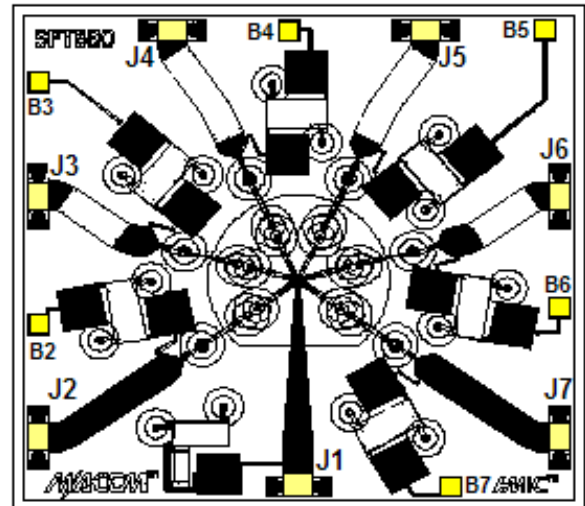

Yellow areas denote wire bond pads

Parameter	Absolute Maximum
Operating Temperature	-65°C to +125°C
Storage Temperature	-65°C to +150°C
Junction Temperature	+175°C
Applied Reverse Voltage	50V
RF Incident Power	+33dBm C.W. ¹
Bias Current +25°C	±20mA

Note:

1. Maximum operating conditions for a combination of RF power, D.C. bias and operating temperature:

+33dBm CW @ 15mA (per diode) @+85°C

ADVANCED: Data Sheets contain information regarding a product MA-COM Technical Solutions is considering for development. Performance is based on target specifications, simulated results, and/or prototype measurements. Commitment to develop is not guaranteed.
PRELIMINARY: Data Sheets contain information regarding a product MA-COM Technical Solutions has under development. Performance is based on engineering tests. Specifications are typical. Mechanical outline has been fixed. Engineering samples and/or test data may be available. Commitment to produce in volume is not guaranteed.

- **North America** Tel: 800.366.2266 / Fax: 978.366.2266
- **Europe** Tel: 44.1908.574.200 / Fax: 44.1908.574.300
- **Asia/Pacific** Tel: 81.44.844.8296 / Fax: 81.44.844.8298

Visit www.macom.com for additional data sheets and product information.

MA-COM Technical Solutions and its affiliates reserve the right to make changes to the product(s) or information contained herein without notice.

MASW-006102-13610

HMIC™ Silicon PIN Diode Switch with Integrated Bias Network

V2

MASW-006102-13610 (SP6T) Electrical Specifications @ T_{AMB} = +25°C, 10mA Bias current

PARAMETER	FREQUENCY BAND	MIN	TYP	MAX	UNITS
INSERTION LOSS	6 GHZ		1.0	1.4	dB
	12 GHZ		1.3	2.0	dB
	18 GHZ		1.9	2.9	dB
ISOLATION	6 GHZ	43	49		dB
	12 GHZ	35	43		dB
	18 GHZ	30	39		dB
INPUT RETURN LOSS	6 GHZ		18		dB
	12 GHZ		20		dB
	18 GHZ		16		dB
OUTPUT RETURN LOSS	6 GHZ		19		dB
	12 GHZ		22		dB
	18 GHZ		20		dB
SWITCHING SPEED	10 GHZ		80		ns

Note:

1. Typical switching speed measured from 10% to 90% of detected RF signal driven by TTL compatible drivers using RC output spiking network, R = 50 – 200Ω , C = 390 – 560pF.

Operation of the MASW-006102-13610

Operation of the MASW Series of PIN switches is achieved by the simultaneous application of negative DC current to the low loss port and positive DC current to the remaining isolated switching ports per the Driver Connections table below. The control currents should be supplied by constant current sources. For insertion loss, -10mA bias results in approximately -2V, and for Isolation, +10mA yields approximately +0.9V at the respective bias nodes. The backside area of the die is the RF and DC return ground plane.

CONTROL LEVEL (DC CURRENT)						CONDITION OF RF OUTPUT					
B2	B3	B4	B5	B6	B7	J2-J1	J3-J1	J4-J1	J5-J1	J6-J1	J7-J1
-10mA	+10mA	+10mA	+10mA	+10mA	+10mA	Low Loss	Isolation	Isolation	Isolation	Isolation	Isolation
+10mA	-10mA	+10mA	+10mA	+10mA	+10mA	Isolation	Low Loss	Isolation	Isolation	Isolation	Isolation
+10mA	+10mA	-10mA	+10mA	+10mA	+10mA	Isolation	Isolation	Low Loss	Isolation	Isolation	Isolation
+10mA	+10mA	+10mA	-10mA	+10mA	+10mA	Isolation	Isolation	Isolation	Low Loss	Isolation	Isolation
+10mA	+10mA	+10mA	+10mA	-10mA	+10mA	Isolation	Isolation	Isolation	Isolation	Low Loss	Isolation
+10mA	+10mA	+10mA	+10mA	+10mA	-10mA	Isolation	Isolation	Isolation	Isolation	Isolation	Low Loss

2

ADVANCED: Data Sheets contain information regarding a product MA-COM Technical Solutions is considering for development. Performance is based on target specifications, simulated results, and/or prototype measurements. Commitment to develop is not guaranteed.

PRELIMINARY: Data Sheets contain information regarding a product MA-COM Technical Solutions has under development. Performance is based on engineering tests. Specifications are typical. Mechanical outline has been fixed. Engineering samples and/or test data may be available. Commitment to produce in volume is not guaranteed.

• **North America** Tel: 800.366.2266 / Fax: 978.366.2266

• **Europe** Tel: 44.1908.574.200 / Fax: 44.1908.574.300

• **Asia/Pacific** Tel: 81.44.844.8296 / Fax: 81.44.844.8298

Visit www.macom.com for additional data sheets and product information.

MA-COM Technical Solutions and its affiliates reserve the right to make changes to the product(s) or information contained herein without notice.

MASW-006102-13610

HMIC™ Silicon PIN Diode Switch with Integrated Bias Network

V2

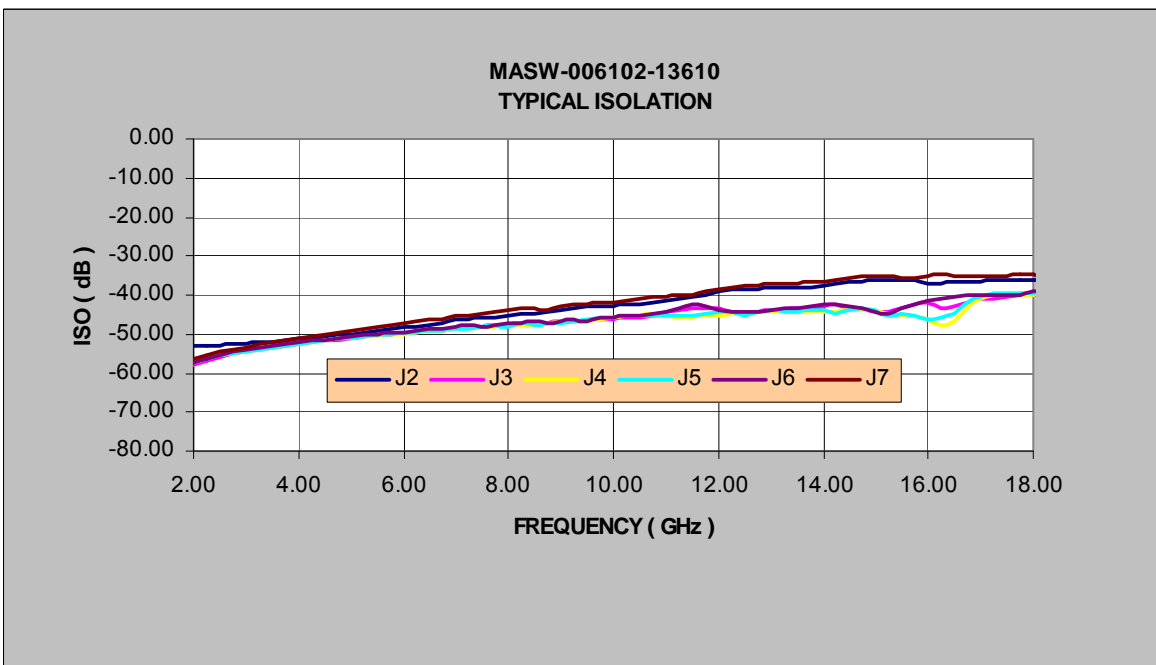
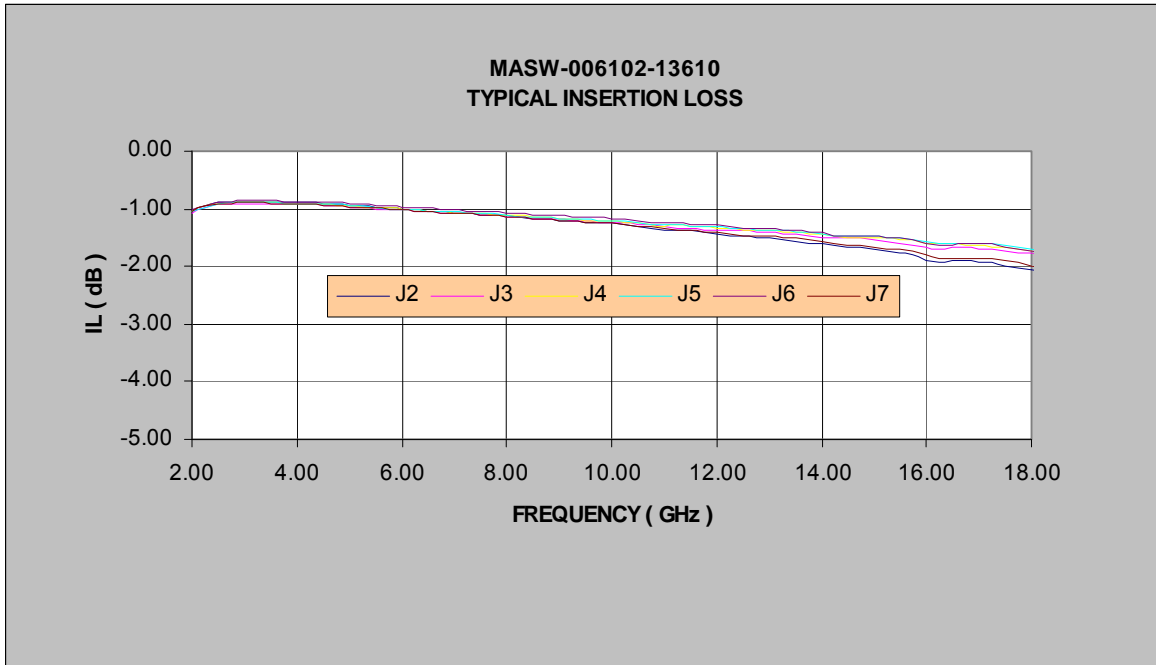

ADVANCED: Data Sheets contain information regarding a product MA-COM Technical Solutions is considering for development. Performance is based on target specifications, simulated results, and/or prototype measurements. Commitment to develop is not guaranteed.
PRELIMINARY: Data Sheets contain information regarding a product MA-COM Technical Solutions has under development. Performance is based on engineering tests. Specifications are typical. Mechanical outline has been fixed. Engineering samples and/or test data may be available. Commitment to produce in volume is not guaranteed.

- **North America** Tel: 800.366.2266 / Fax: 978.366.2266
- **Europe** Tel: 44.1908.574.200 / Fax: 44.1908.574.300
- **Asia/Pacific** Tel: 81.44.844.8296 / Fax: 81.44.844.8298

Visit www.macom.com for additional data sheets and product information.

MA-COM Technical Solutions and its affiliates reserve the right to make changes to the product(s) or information contained herein without notice.

MASW-006102-13610

HMIC™ Silicon PIN Diode Switch with Integrated Bias Network

V2

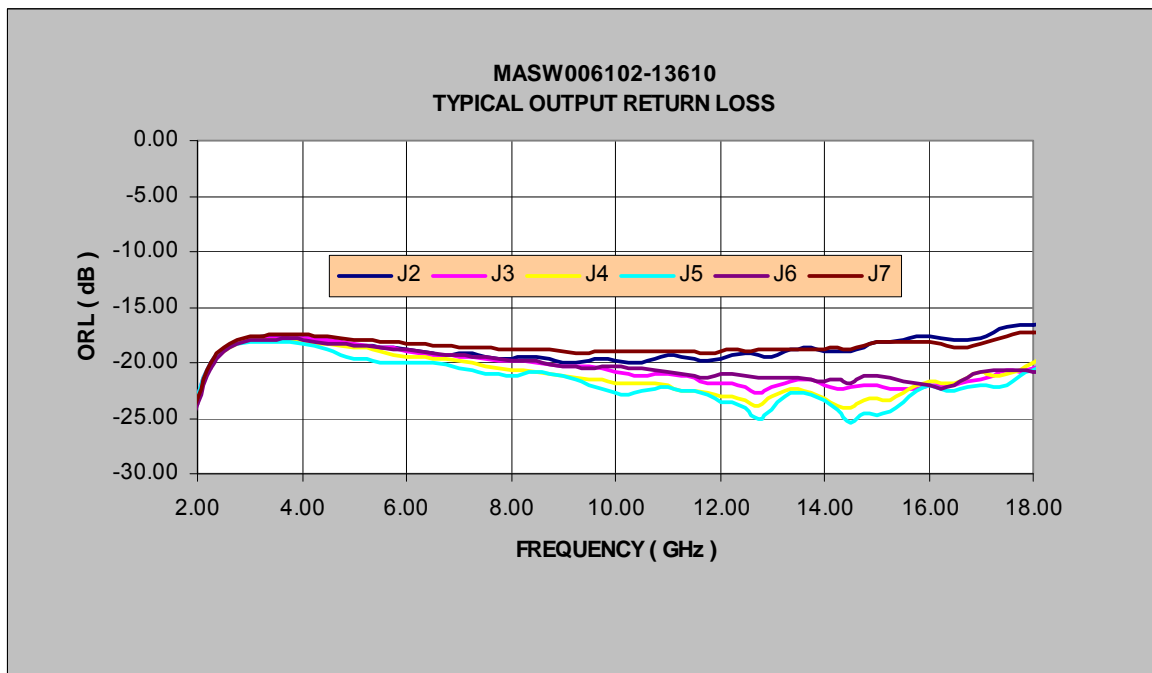
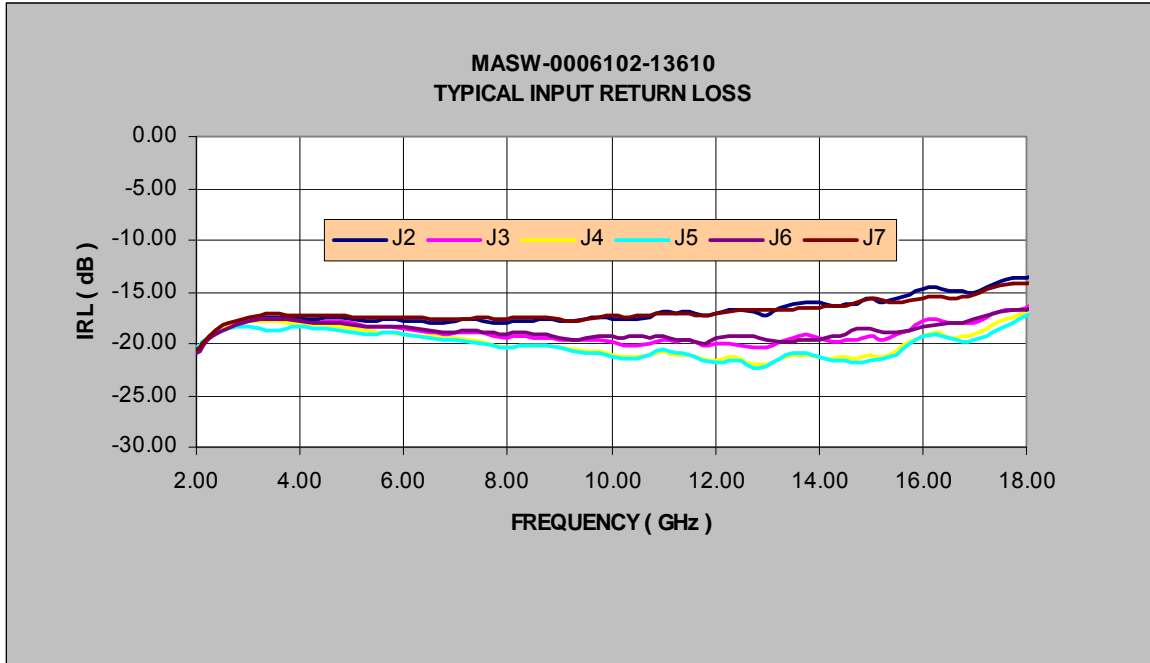

ADVANCED: Data Sheets contain information regarding a product MA-COM Technical Solutions is considering for development. Performance is based on target specifications, simulated results, and/or prototype measurements. Commitment to develop is not guaranteed.
PRELIMINARY: Data Sheets contain information regarding a product MA-COM Technical Solutions has under development. Performance is based on engineering tests. Specifications are typical. Mechanical outline has been fixed. Engineering samples and/or test data may be available. Commitment to produce in volume is not guaranteed.

- **North America** Tel: 800.366.2266 / Fax: 978.366.2266
 - **Europe** Tel: 44.1908.574.200 / Fax: 44.1908.574.300
 - **Asia/Pacific** Tel: 81.44.844.8296 / Fax: 81.44.844.8298
- Visit www.macom.com for additional data sheets and product information.

MA-COM Technical Solutions and its affiliates reserve the right to make changes to the product(s) or information contained herein without notice.

MASW-006102-13610 Schematic

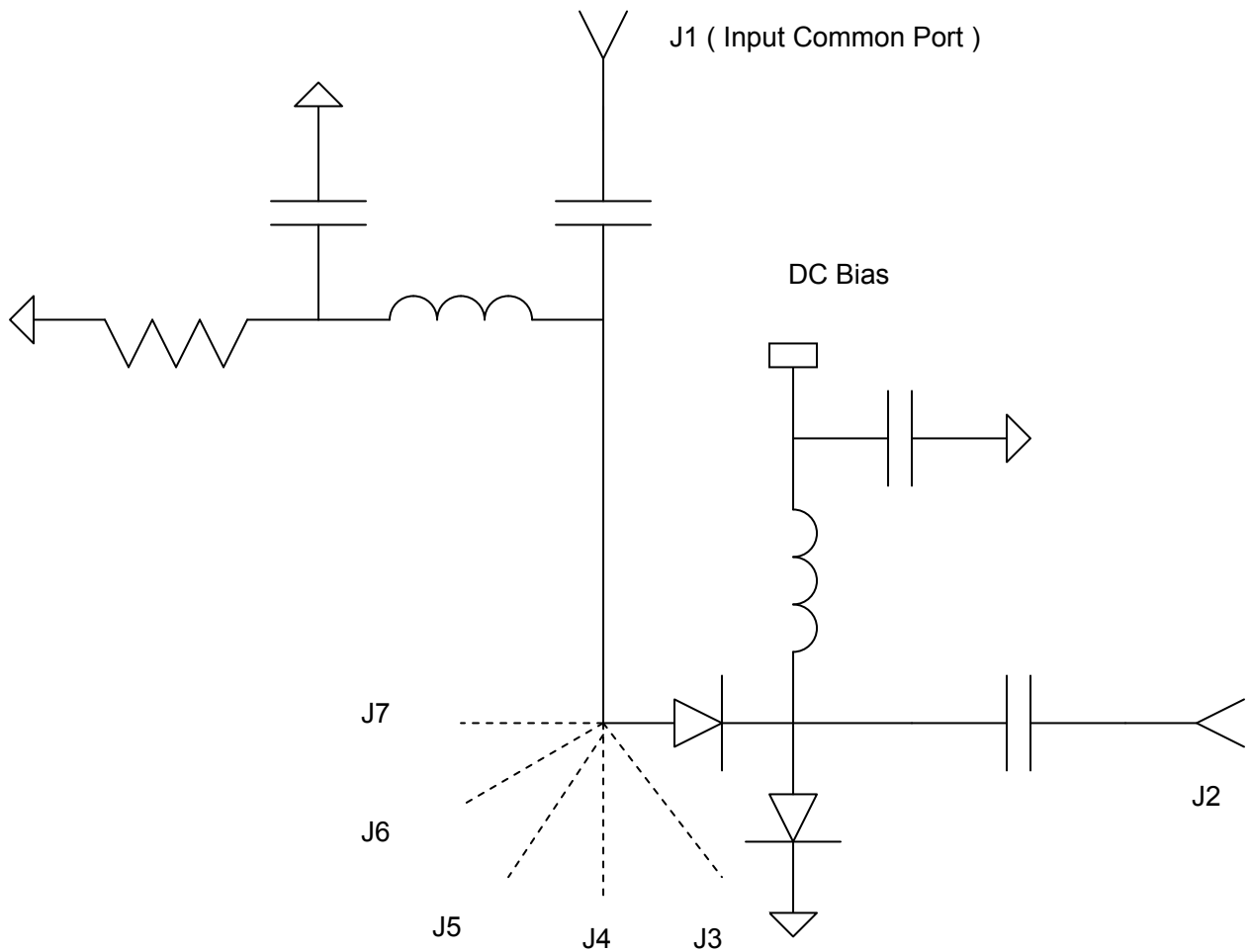

MASW-006102-13610
Chip Outline Drawing^{1,2}

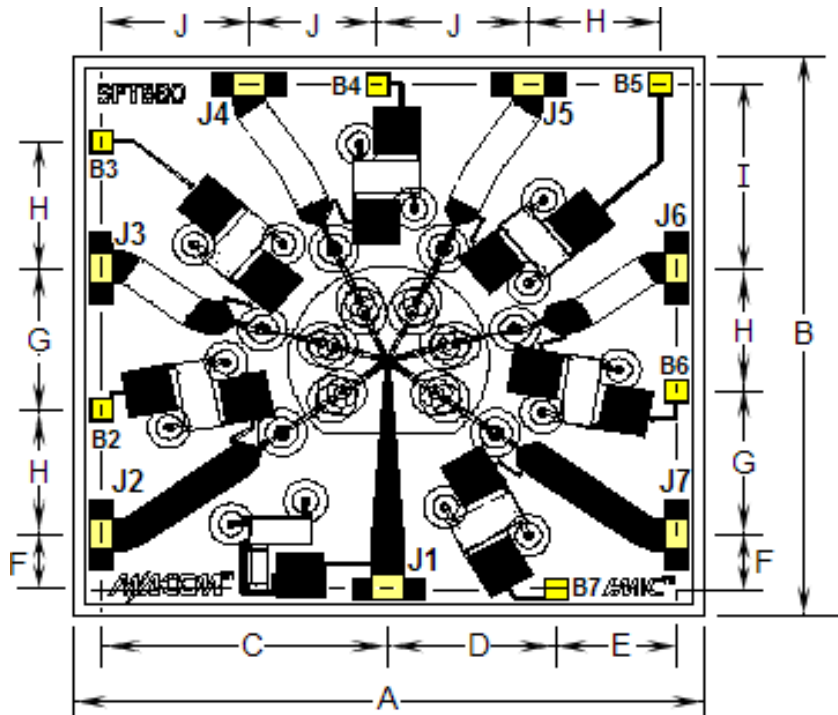

DIM	INCHES		MILLIMETERS	
	MIN	MAX	MIN	MAX
A	.1325	.1335	3.3655	3.3909
B	.1225	.1235	3.1115	3.1369
C	.0595	.0605	1.5113	1.5367
D	.0345	.0355	0.8763	0.9017
E	.0245	.0255	0.6223	0.6477
F	.0115	.0125	0.2921	0.3175
G	.0305	.0315	0.7747	0.8001
H	.0275	.0285	0.6985	0.7239
I	.0395	.0405	1.0033	1.0287
J	.0295	.0305	0.7493	0.7747
RF Bond Pads (J1-J7)	.016 X .005 REF.		0.4064 X 0.127 REF.	
DC Bond Pads (B2-B5)	.005 X .005 REF.		.127 X .127 REF.	
Thickness	0.005 REF.		0.127 REF.	

Notes:

1. Topside and backside metallization is gold , 2.5mm thick typical.
2. Yellow areas indicate wire bonding pads

Wire/Ribbon and Die Attachment Recommendations

Cleanliness

These chips should be handled in a clean environment.

Wire Bonding

Thermosonic wedge wire bonding using 0.00025" x 0.003" ribbon or 0.001" diameter gold wire is recommended. A heat stage temperature of 150°C and a force of 18 to 22 grams should be used. Ultrasonic energy should be adjusted to the minimum required to achieve a good bond. RF bond wires should be kept as short and straight as possible.

Mounting

The HMIC switches have Ti-Pt-Au back metal. They can be die mounted with a gold-tin eutectic solder preform or conductive epoxy. Mounting surface must be clean and flat.

Eutectic Die Attachment

An 80/20, gold-tin, eutectic solder preform is recommended with a work surface temperature of 255°C and a tool tip temperature of 265°C. When hot gas is applied, the tool tip temperature should be 290°C. The chip should not be exposed to temperatures greater than 320°C for more than 20 seconds. No more than three seconds should be required for attachment. Solders containing tin should not be used.

Epoxy Die Attachment

A minimum amount of epoxy should be used. A thin epoxy fillet should be visible around the perimeter of the chip after placement. Cure epoxy per manufacturer's schedule. (typically 125-150°C).

Ordering Information

Part Number	Package
MASW-006102-13610W	Waffle Pack