

## Dual Half Bridge Driver with Boost Converter

### ■ GENERAL DESCRIPTION

The **NJW4813** is a dual half bridge driver with boost converter IC.

Output voltage boost from Li-ion battery and a 5V power supply and can drive a piezo device by two half bridge drivers.

The NJW4813 is able to stable startup by soft start function in boost SW.REG.

The dual half bridge driver improves control characteristics from a microcomputer in response to independent signal input in each channel.

The input frequency operates to 300kHz and in the case of failure, it can output a fault flag.

### ■ PACKAGE OUTLINE

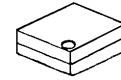

**NJW4813SE3**

### ■ FEATURES

#### ● Boost Converter Block

Output Switch Voltage	40V max.
Switching Current	1A min.
PWM Control	
Operating Voltage Range	2.7 to 5.5V
Oscillation Frequency Range	380k to 810kHz
Soft Start Function	17ms typ.
Over Current Protection	

#### ● Half Bridge Driver Block

Internal 2-Channel Half Bridge	
Each Channel Operates Individually	
Output Switch Peak Current	+280 / -250mA typ.
Operating Voltage Range	8.0 to 35V
Switching Frequency	300kHz max.
Output Shut Down Control	
Over Current Protection	
Fault Indicator Output	

#### ● Under Voltage Lockout

#### ● Built-in Thermal Shutdown

#### ● Standby Function

#### ● Package Outline

NJW4813SE3 : PCSP20-E3

# NJW4813

## ■ PIN CONFIGURATION

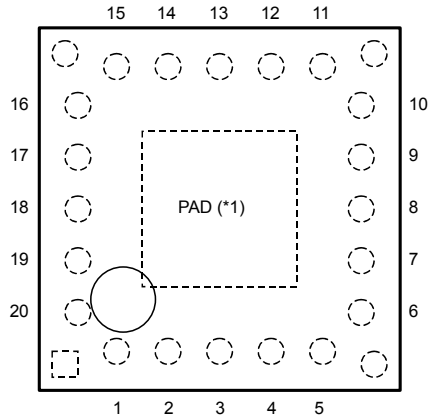

< Top View >

### PIN FUNCTION

- |           |            |
|-----------|------------|
| 1. VDD_SW | 11. VDD_HB |
| 2. STBYb  | 12. OUT1   |
| 3. SHDNb  | 13. PGND   |
| 4. IN1    | 14. PGND   |
| 5. IN2    | 15. SW     |
| 6. FLT    | 16. SW     |
| 7. RT     | 17. NC     |
| 8. GND    | 18. RADJ   |
| 9. PGND   | 19. FB     |
| 10. OUT2  | 20. IN-    |

(\*1) The PAD is not connected to an IC chip electrically.

## NJW4813SE3

## ■ BLOCK DIAGRAM

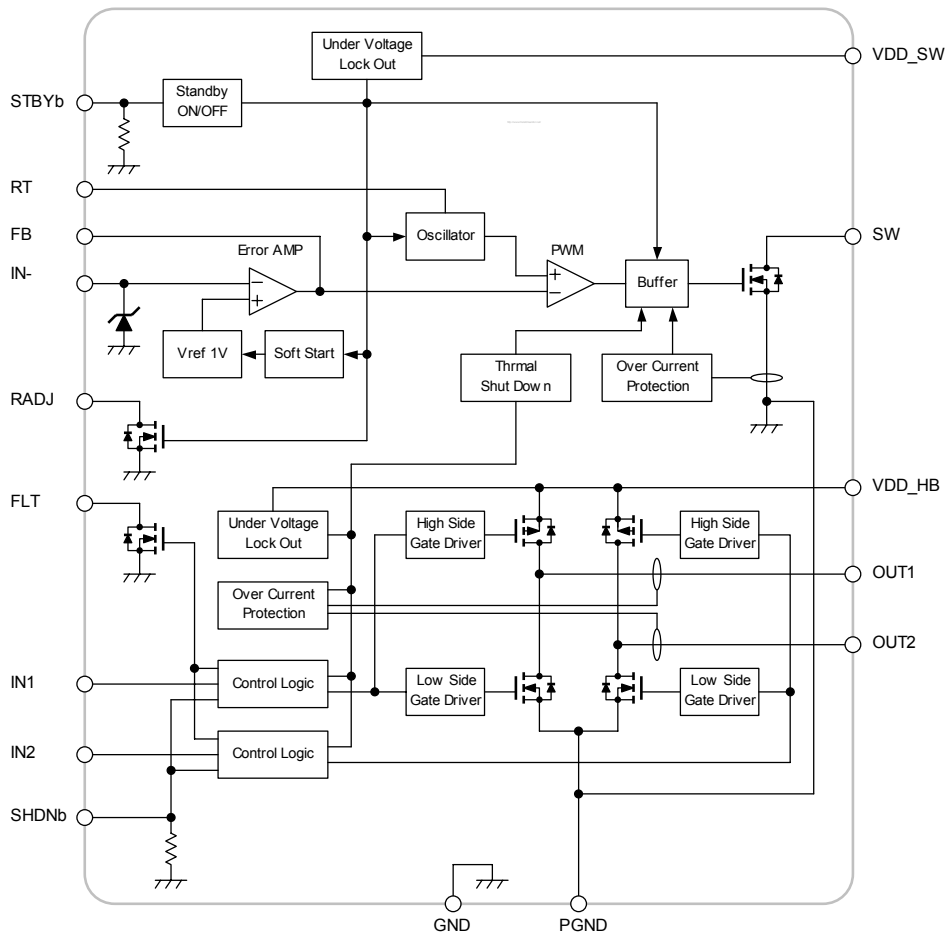

## ■ ABSOLUTE MAXIMUM RATINGS

(Ta=25°C)

PARAMETER	SYMBOL	MAXIMUM RATINGS	UNIT
<b>Boost Converter Block</b>			
Supply Voltage	$V_{DD\_SW}$	+6	V
SW pin Voltage	$V_{SW}$	+40	V
RADJ pin Voltage	$V_{RADJ}$	+6 (*2)	V
IN- pin Voltage	$V_{IN-}$	-0.3 to +6 (*2)	V
STBYb pin Voltage	$V_{STBYb}$	-0.3 to +6 (*2)	V
<b>Half Bridge Driver Block</b>			
Supply Voltage	$V_{DD\_HB}$	+40	V
SHDNb pin Voltage	$V_{SHDNb}$	-0.3 to +6 (*2)	V
Input Voltage	$V_{IN1}$ $V_{IN2}$	-0.3 to +6 (*2)	V
FLT pin Voltage	$V_{FLT}$	-0.3 to +6	V
Power Dissipation	$P_D$	The back pad is mounted. 560 (*3) 980 (*4) The back pad is not mounted. 550 (*3) 850 (*4)	mW
Junction Temperature Range	$T_j$	-40 to +150	°C
Operating Temperature Range	$T_{opr}$	-40 to +85	°C
Storage Temperature Range	$T_{stg}$	-40 to +150	°C

(\*2): When Supply voltage is less than +6V, the absolute maximum voltage is equal to the Supply voltage.

(\*3): Mounted on glass epoxy board. (76.2×114.3×1.6mm:based on EIA/JDEC standard, 2Layers)

(\*4): Mounted on glass epoxy board. (76.2×114.3×1.6mm:based on EIA/JDEC standard, 4Layers),  
internal Cu area: 74.2×74.2mm

This product may be damaged with electric static discharge (ESD).

Please handle with care to avoid these damages.

## ■ RECOMMENDED OPERATING CONDITIONS

PARAMETER	SYMBOL	MIN.	TYP.	MAX.	UNIT
<b>Boost Converter Block</b>					
Supply Voltage	$V_{DD\_SW}$	2.7	—	5.5	V
STBYb pin Voltage	$V_{STBYb}$	0	—	$V_{DD\_SW}$	V
Timing Resistor	$R_T$	95	100	146	kΩ
Oscillating Frequency	$f_{OSC}$	380	700	810	KHz
<b>Half Bridge Driver Block</b>					
Supply Voltage	$V_{DD\_HB}$	8	—	35	V
Output Switch DC Current	$I_{OM}$	0	—	20	mA
SHDNb pin Voltage	$V_{SHDNb}$	0	—	$V_{DD\_SW}$	V
Input Voltage	$V_{IN1}, V_{IN2}$	0	—	$V_{DD\_SW}$	V
FLT pin Voltage	$V_{FLT}$	0	—	5.5	V

# NJW4813

## ■ ELECTRICAL CHARACTERISTICS

### Boost Converter Block

(Unless otherwise noted,  $V_{DD\_SW}=V_{STBYb}=3.7V$ ,  $R_T=100k\Omega$ ,  $T_a=25^\circ C$ )

PARAMETER	SYMBOL	TEST CONDITION	MIN.	TYP.	MAX.	UNIT
-----------	--------	----------------	------	------	------	------

### Under Voltage Lockout Block

UVLO Release Voltage	$V_{RUVLO\_SW}$		2.1	2.4	2.7	V
UVLO Operate Voltage	$V_{DUVLO\_SW}$		2.0	2.2	2.5	V
UVLO Hysteresis Voltage	$\Delta V_{UVLO\_SW}$	$V_{RUVLO\_SW} - V_{DUVLO\_SW}$	–	0.2	–	V

### Soft Start Block

Soft Start Time	$T_{SS}$	$V_B=0.95V$	8	17	28	ms
-----------------	----------	-------------	---	----	----	----

### Oscillator Block

Oscillation Frequency	$f_{OSC}$		630	700	770	kHz
Oscillation Frequency deviation (Supply voltage)	$f_{DV}$	$V_{DD\_SW}=3.0$ to $5.5V$	–	1	–	%
Oscillation Frequency deviation (Temperature)	$f_{DT}$	$T_a= -40$ to $+85^\circ C$	–	3	–	%

### Error Amplifier Block

Reference Voltage	$V_B$	Short IN- and FB, Measuring IN- Pin	-1.0%	1.00	+1.0%	V
Input Bias Current	$I_B$	$V_B=1.0V$	-0.1	–	+0.1	$\mu A$
Open Loop Gain	$A_V$		–	80	–	dB
Gain Bandwidth	$G_B$		–	1	–	MHz
Output Source Current	$I_{OM+}$	$V_{FB}=1V$ , $V_{IN-}=0.9V$	8	16	24	$\mu A$
Output Sink Current	$I_{OM-}$	$V_{FB}=1V$ , $V_{IN-}=1.1V$	0.9	1.4	4	mA
IN- pin Clamp Voltage	$V_{CLIN-}$	$V_{STBYb}=0V$ , $V_{DD\_SW}=5.5V$ , $I_{CLIN-}=10\mu A$	4.8	5.2	5.6	V
RADJ pin FET ON Resistance	$R_{ON\_RADJ}$	$I_{RADJ}=0.1mA$	–	200	280	$\Omega$
RADJ pin FET Leak Current	$I_{LEAK\_RADJ}$	$V_{STBYb}=0V$ , $V_{RADJ}=3.3V$	–	–	1	$\mu A$

### PWM Compare Block

Maximum Duty Cycle	$M_{AXDUTY}$	$V_{IN-}=0.9V$	82	87	92	%
--------------------	--------------	----------------	----	----	----	---

### Output Block

Output ON Resistance	$R_{ON\_SW}$	$I_{SW}=100mA$	–	0.6	1.2	$\Omega$
Switching Current Limit	$I_{LMT\_SW}$		1	2	–	A
Switching Leak Current	$I_{LEAK\_SW}$	$V_{STBYb}=0V$ , $V_{SW}=40V$	–	–	1	$\mu A$

## ■ ELECTRICAL CHARACTERISTICS

### Half Bridge Driver Block

(Unless otherwise noted,  $V_{DD\_SW}=3.7V$ ,  $V_{DD\_HB}=25V$ ,  $V_{STBYb}=V_{SHDNb}=3.7V$ ,  $R_T=100k\Omega$ ,  $T_a=25^\circ C$ )

PARAMETER	SYMBOL	TEST CONDITION	MIN.	TYP.	MAX.	UNIT
-----------	--------	----------------	------	------	------	------

#### Under Voltage Lockout Block

UVLO Release Voltage	$V_{RUVLO\_HB}$		5.6	6.2	6.8	V
UVLO Operate Voltage	$V_{DUVLO\_HB}$		5.0	5.6	6.2	V
UVLO Hysteresis Voltage	$\Delta V_{UVLO\_HB}$	$V_{RUVLO\_HB} - V_{DUVLO\_HB}$	–	0.6	–	V

#### Enable Control Block

High Side SW ON Resistance	$R_{DSSH}$	$I_{OSOURCE}=20mA$	–	6.0	8.0	$\Omega$	
Low Side SW ON Resistance	$R_{DSL}$	$I_{OSINK}=20mA$	–	7.0	9.0	$\Omega$	
Output Current Limit Circuit	Over Current Detection Current	$I_{DCTH}$	High-Side	230	280	330	mA
		$I_{DCTL}$	Low-Side	200	250	300	mA
	Over Current Release Current	$I_{RCVH}$	High-Side	2.5	5	10	mA
		$I_{RCVL}$	Low-Side	5	10	20	mA
	Output Short Current	$I_{SHTH}$	$V_{OUT1}=V_{OUT2}=0V$	10	25	50	mA
$I_{SHTL}$		$V_{OUT1}=V_{OUT2}=V_{DD\_HB}$	10	25	50	mA	
Output Rise Time	$t_r$	$V_{IN}=0$ to 3.3V	–	400	–	ns	
Output Fall Time	$t_f$	$V_{IN}=0$ to 3.3V	–	400	–	ns	
Rise Dead Time	$D_{tr}$	$V_{IN}=0$ to 3.3V	–	150	–	ns	
Fall Dead Time	$D_{tf}$	$V_{IN}=0$ to 3.3V	–	150	–	ns	
Rise Delay Time	$t_{d\_ON}$	$V_{IN}=0$ to 3.3V	–	250	–	ns	
Fall Delay Time	$t_{d\_OFF}$	$V_{IN}=0$ to 3.3V	–	250	–	ns	
Rise – Fall Delay Time Difference	$t_{d\_ON} \pm t_{d\_OFF}$	$V_{IN}=0$ to 3.3V	–	20	–	ns	
Input Frequency	$f_{IN}$		–	–	300	kHz	
High Side SW OFF Leak Current	$I_{OLEAKOUTH}$	$V_{SHDNb}=0V$ , $V_{DD\_HB}=25V$ $V_{OUT1}=V_{OUT2}=0V$	–	–	1	$\mu A$	
Low Side SW OFF Leak Current	$I_{OLEAKOUTL}$	$V_{SHDNb}=0V$ , $V_{DD\_HB}=25V$ $V_{OUT1}=V_{OUT2}=25V$	–	–	1	$\mu A$	
OUT pin – VDD pin Potential Difference	$V_{PDOV}$	$V_{SHDNb}=0V$ , $I_{ORH}=20mA$	–	0.7	1.0	V	
GND pin – OUT pin Potential Difference	$V_{PDGO}$	$V_{SHDNb}=0V$ , $I_{ORL}=20mA$	–	0.7	1.0	V	

#### Shutdown Circuit Block

SHDNb pin High Voltage (Operating Mode)	$V_{IHSHDNb}$		1.6	–	$V_{DD\_SW}$	V
SHDNb pin Low Voltage (Shutdown Mode)	$V_{ILSHDNb}$		0	–	0.6	V
SHDNb pin Pull Down Resistance	$R_{PDSDNB}$	$V_{SHDNb}=3.3V$	210	300	390	$k\Omega$

#### Input Circuit Block

IN1, IN2 pin High Voltage	$V_{IHIN1}$ , $V_{IHIN2}$		1.6	–	$V_{DD\_SW}$	V
IN1, IN2 pin Low Voltage	$V_{ILIN1}$ , $V_{ILIN2}$		0	–	0.6	V
IN1, IN2 pin Input Current	$I_{IIN1}$ , $I_{IIN2}$	$V_{IN}=3.3V$	–	–	1	$\mu A$

# NJW4813

## ■ ELECTRICAL CHARACTERISTICS

### General Characteristics

(Unless otherwise noted,  $V_{DD\_SW}=3.7V$ ,  $V_{DD\_HB}=25V$ ,  $V_{STBYb}=V_{SHDNb}=3.7V$ ,  $R_T=100k\Omega$ ,  $T_a=25^\circ C$ )

PARAMETER	SYMBOL	TEST CONDITION	MIN.	TYP.	MAX.	UNIT
STBYb pin High Voltage (Operating Mode)	$V_{IHSTBYb}$		1.6	–	$V_{DD\_SW}$	V
STBYb pin Low Voltage (Standby Mode)	$V_{ILSTBYb}$		0	–	0.6	V
STBYb pin Pull Down Resistance	$R_{PDSTBYb}$	$V_{STBYb}=3.3V$	210	300	390	$k\Omega$
FLT pin Low Level Output Voltage	$V_{LFLT}$	$I_{FLT}=500\mu A$	–	0.25	0.5	V
FLT pin OFF Leak Current	$I_{OLEAKFLT}$	$V_{FLT}=5.5V$	–	–	1	$\mu A$
Quiescent Current (Switching Regulator Block)	$I_{QSW}$	$R_T=100k\Omega$ , No Load	–	1.9	2.8	mA
Quiescent Current (Half Bridge Driver Block)	$I_{QHB}$	$f_{IN1}=f_{IN2}=10kHz$ antiphase 50% Duty Cycle	–	0.7	1.0	mA
Quiescent Current (Standby)	$I_{QSTBY}$	$V_{DD\_HB}=0V$ , $V_{STBYb}=V_{SHDNb}=0V$	–	0.9	1.8	$\mu A$

## ■ TYPICAL CHARACTERISTICS (Boost Converter Block)

Timing Resistor vs. Oscillation Frequency  
( $V_{DD\_SW}=3.7V$ ,  $T_a=25^\circ C$ )

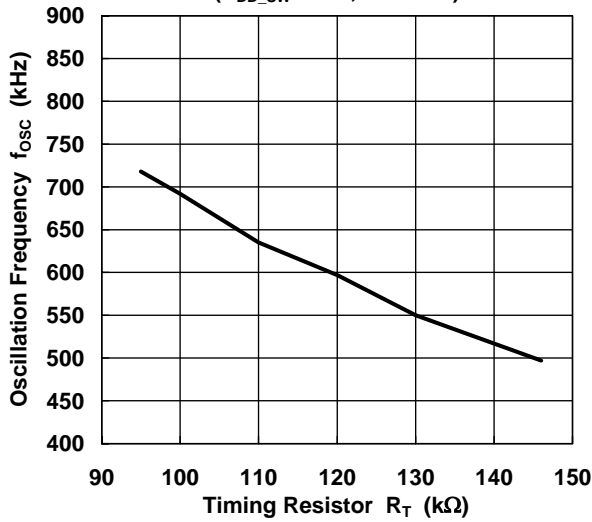

Oscillation Frequency vs. Temperature  
( $V_{DD\_SW}=3.7V$ ,  $R_T=100k\Omega$ )

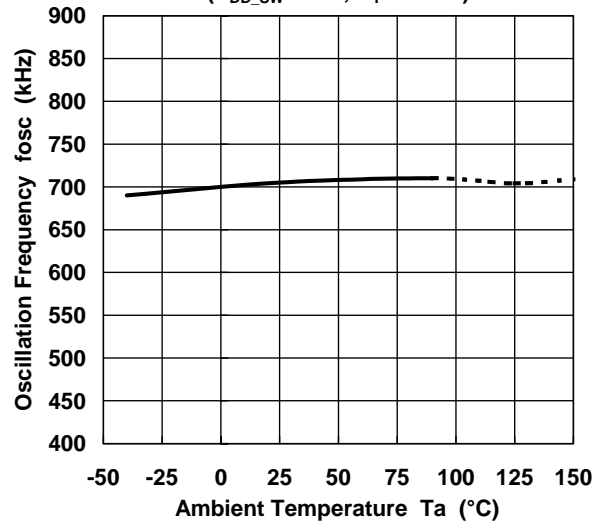

Reference Voltage vs. Temperature  
( $V_{DD\_SW}=3.7V$ )

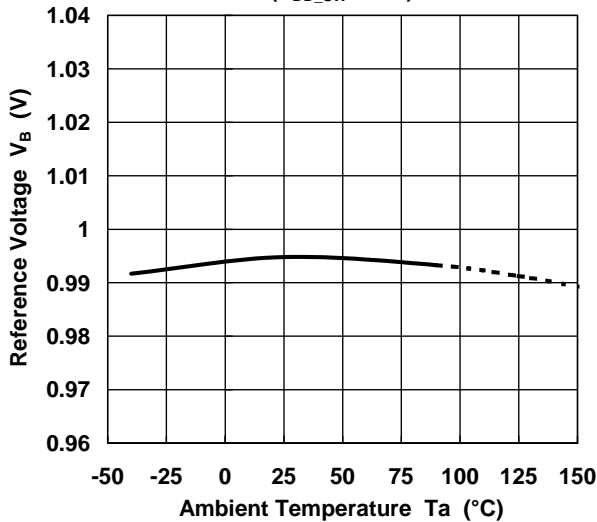

Output ON Resistance vs. Temperature  
( $V_{DD\_SW}=3.7V$ ,  $I_{SW}=100mA$ )

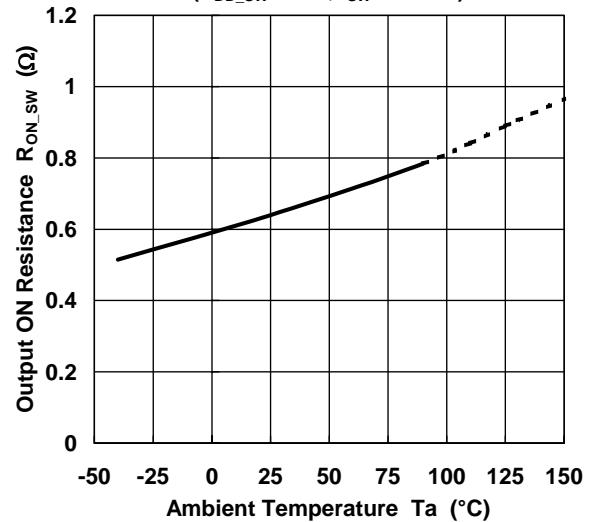

Switching Current Limit vs. Temperature  
( $V_{DD\_SW}=3.7V$ )

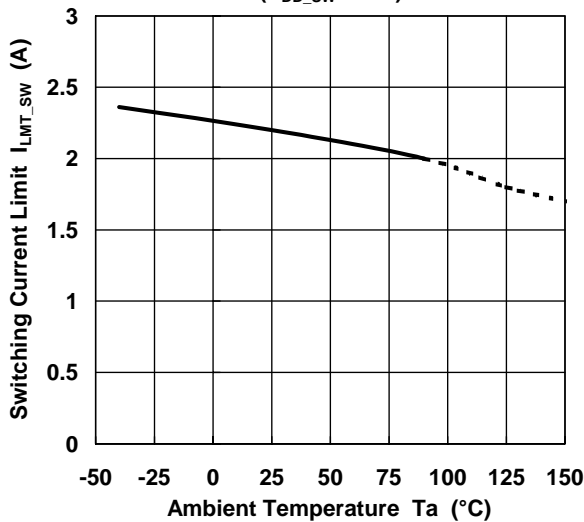

## ■ TYPICAL CHARACTERISTICS (Half Bridge Driver Block)

**Output Current Limit Characteristics (High Side,  $V_{DD\_HB}=35V$ ,  $T_a=25^\circ C$ )**

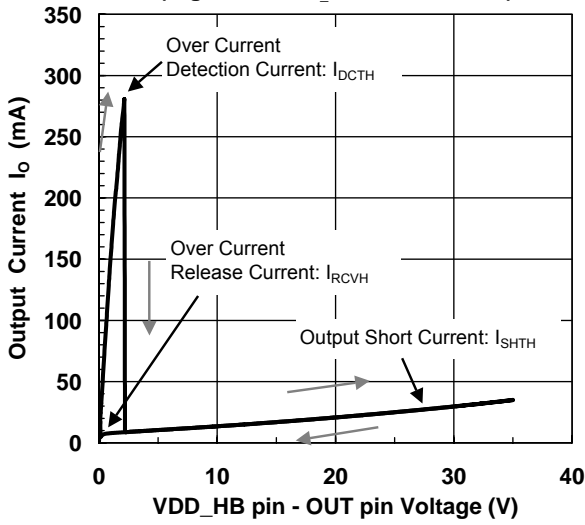

**Output Current Limit Characteristics (Low Side,  $V_{DD\_HB}=35V$ ,  $T_a=25^\circ C$ )**

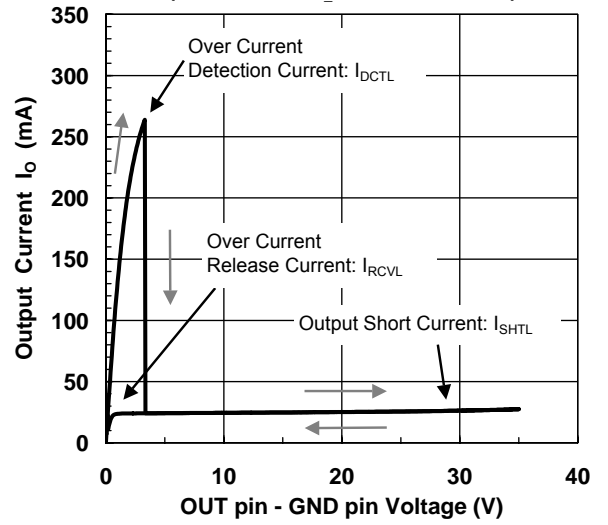

**Output Current Limit vs. Temperature (High Side,  $V_{DD\_HB}=35V$ )**

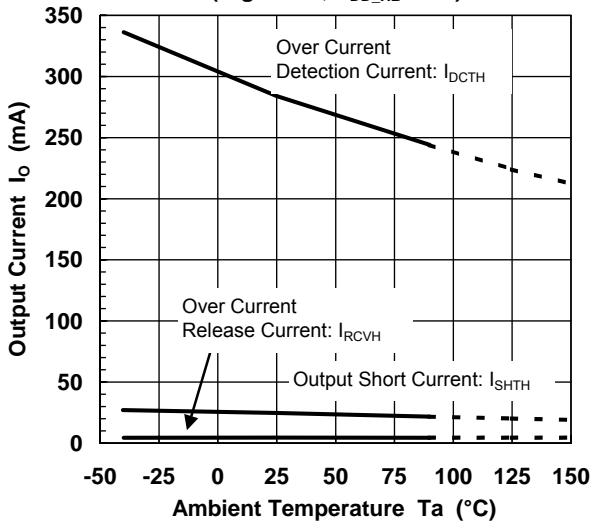

**Output Current Limit vs. Temperature (Low Side,  $V_{DD\_HB}=35V$ )**

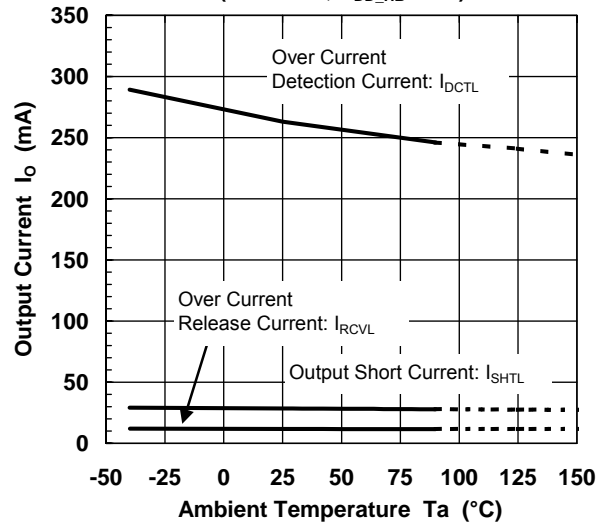



■ TYPICAL CHARACTERISTICS (Half Bridge Driver Block)

High Side SW ON Resistance vs. Temperature  
( $V_{DD\_HB}=25V$ ,  $I_{OSOURCE}=20mA$ )

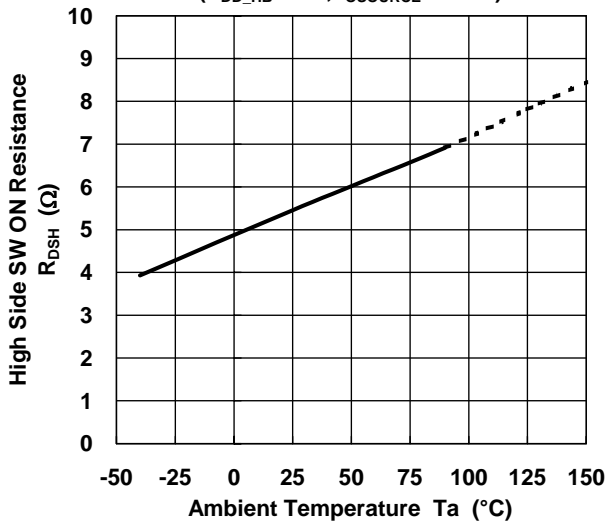

Low Side SW ON Resistance vs. Temperature  
( $V_{DD\_HB}=25V$ ,  $I_{OSINK}=20mA$ )

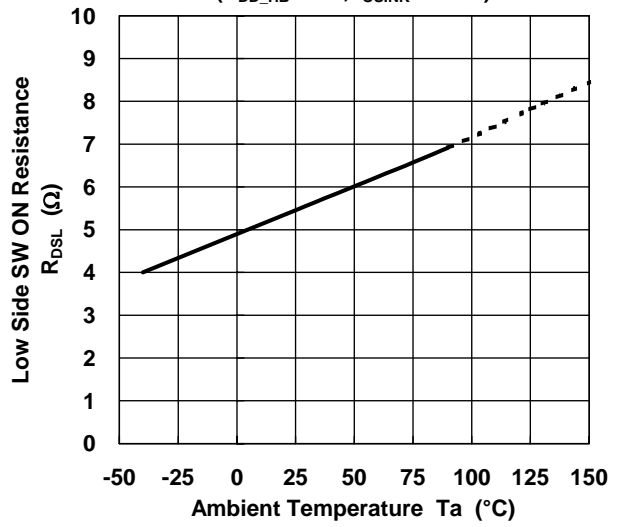

Output Rise Time vs. Temperature  
( $V_{DD\_HB}=25V$ ,  $V_{IN}=0$  to 3.3V)

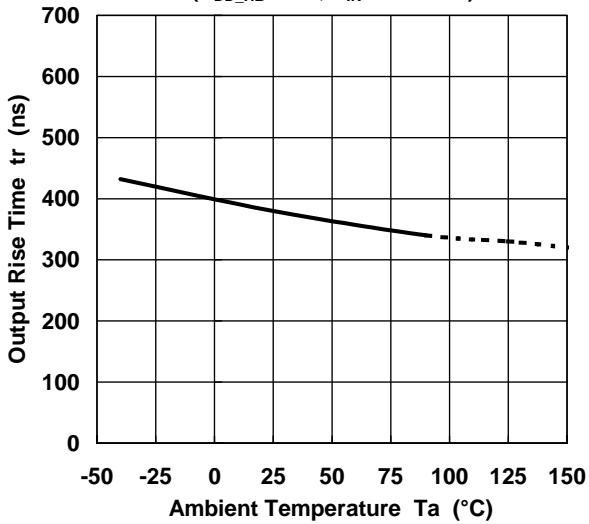

Output Fall Time vs. Temperature  
( $V_{DD\_HB}=25V$ ,  $V_{IN}=0$  to 3.3V)

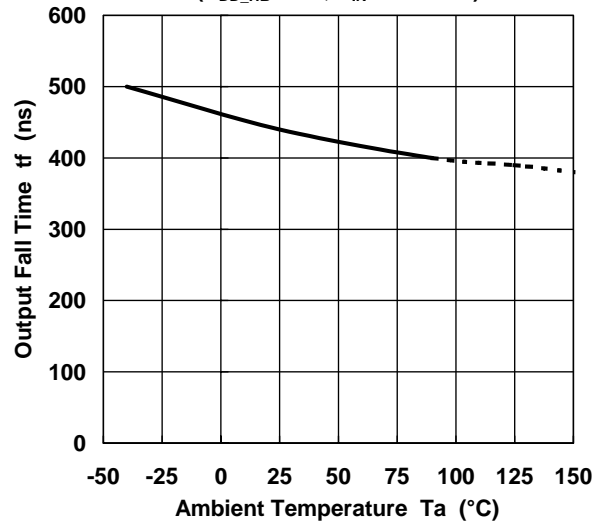

## ■ TYPICAL CHARACTERISTICS (General Characteristics)

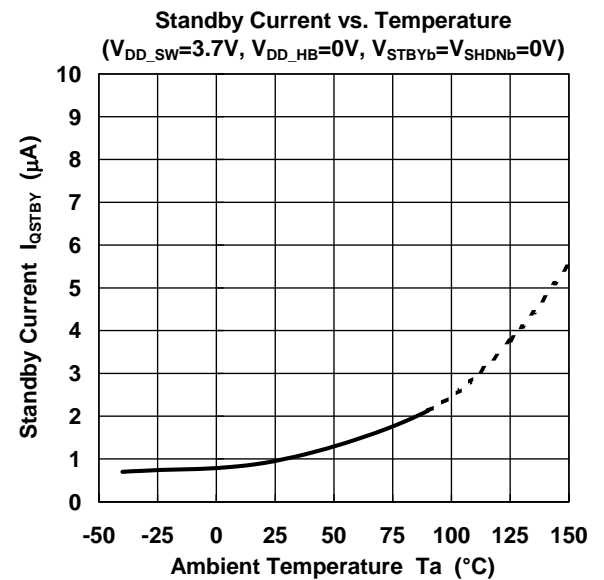
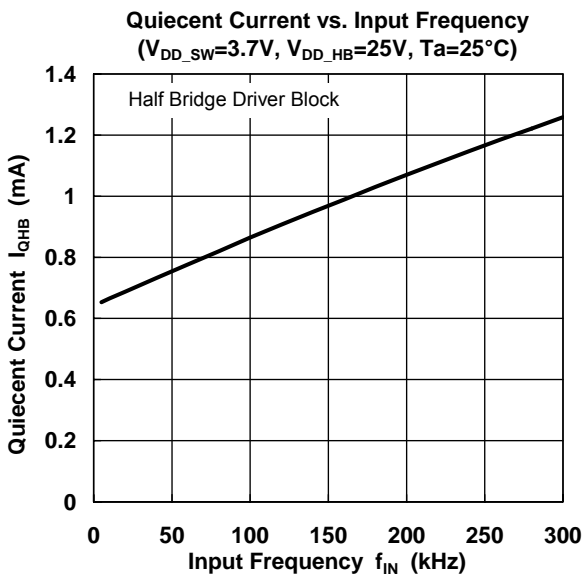
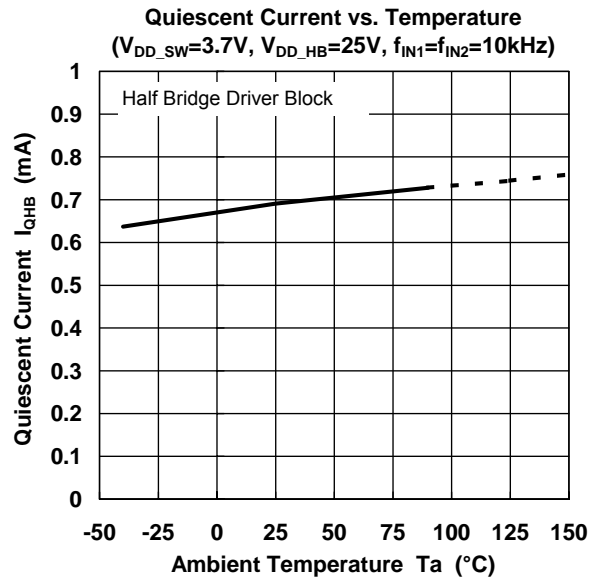
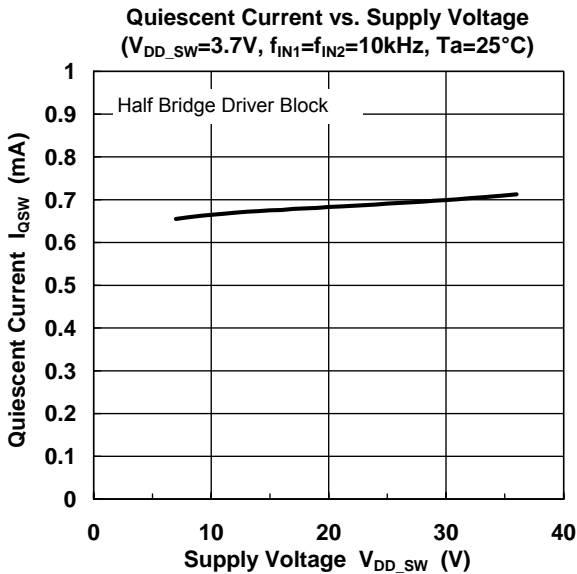
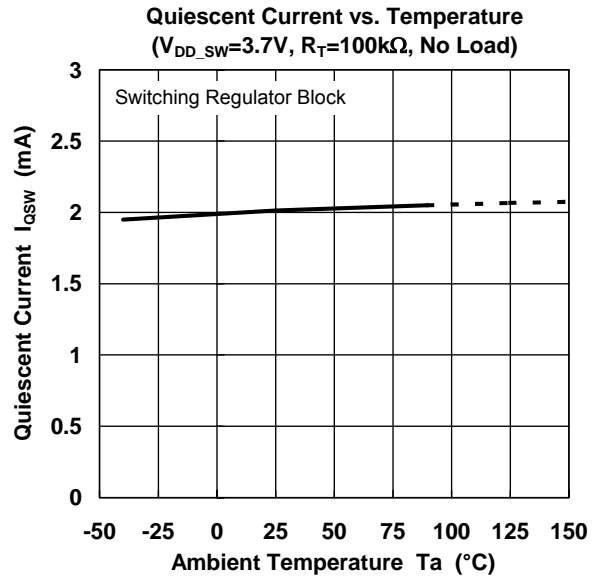
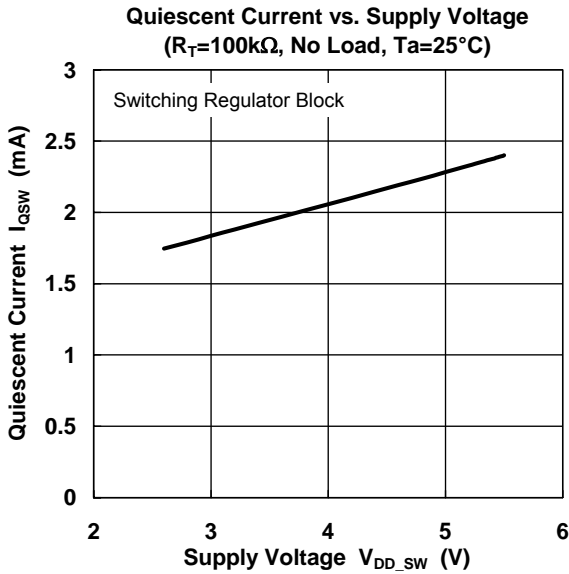

■ Switching Regulator Block Pin Operation Table

INPUT		OUTPUT			Mode
STBYb	VDD_SW	FLT	Feed back Switch	Power MOS FET	
L	–	Hi-Z	OFF	OFF	Stand-by
H	$< V_{DUVLO\_SW}$	L	OFF	OFF	UVLO
H	$\geq V_{RUVLO\_SW}$	Hi-Z	ON	ON	Active

INPUT		OUTPUT			Mode
Tj	I <sub>sw</sub>	FLT	Feed back Switch	Power MOS FET	
$>165^{\circ}\text{C}$	–	L	OFF	OFF	TSD (*4)
–	$\geq I_{LMTSW}$	L	OFF	OFF	OCP (*5)

(\*4) After the TSD function operates, it returns by  $T_j < 125^{\circ}\text{C}$ .

(\*5) Power MOSFET is controlled by a pulse-by-pulse after an OCP function.

■ Switching Regulator Block Pin Operation Table

INPUT		OUTPUT	
IN1	IN2	OUT1	OUT2
L	L	L	L
L	H	L	H
H	L	H	L
H	H	H	H

INPUT				OUTPUT			Mode	
IN1, IN2	STBYb	SHDNb	VDD_HB	FLT	OUT1	OUT2	SW.REG	Half Bridge Driver
L or H	L	L	–	Hi-Z	Hi-Z	Hi-Z	Stand-by	
L or H	L	H	–	Hi-Z	Hi-Z	Hi-Z	Stand-by	
L or H	H	L	$< V_{DUVLO\_HB}$	L	Hi-Z	Hi-Z	Active	UVLO
L or H	H	L	$\geq V_{RUVLO\_HB}$	Hi-Z	Hi-Z	Hi-Z	Active	Shutdown
L or H	H	H	$< V_{DUVLO\_HB}$	L	Hi-Z	Hi-Z	Active	UVLO
L or H	H	H	$\geq V_{RUVLO\_HB}$	Hi-Z	L or H	L or H	Active	

INPUT			OUTPUT			Mode
Tj	I <sub>OUT1</sub>	I <sub>OUT2</sub>	FLT	OUT1	OUT2	
$>165^{\circ}\text{C}$	–	–	L	Hi-Z	Hi-Z	TSD (*4)
–	$\geq I_{DCTH1}, I_{DCTL1}$	–	Hi-Z	I <sub>SHTH1</sub> , I <sub>SHTL1</sub>	L or H	CC (*6)
–	–	$\geq I_{DCTH2}, I_{DCTL2}$	Hi-Z	L or H	I <sub>SHTH2</sub> , I <sub>SHTL2</sub>	CC (*6)

(\*6) After CC(Constant Current) function, an output is controlled by constant current.

## ■ Timing Chart

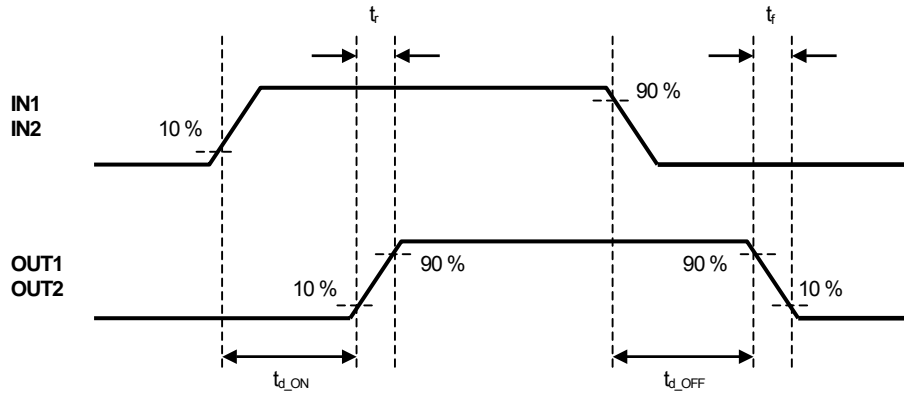
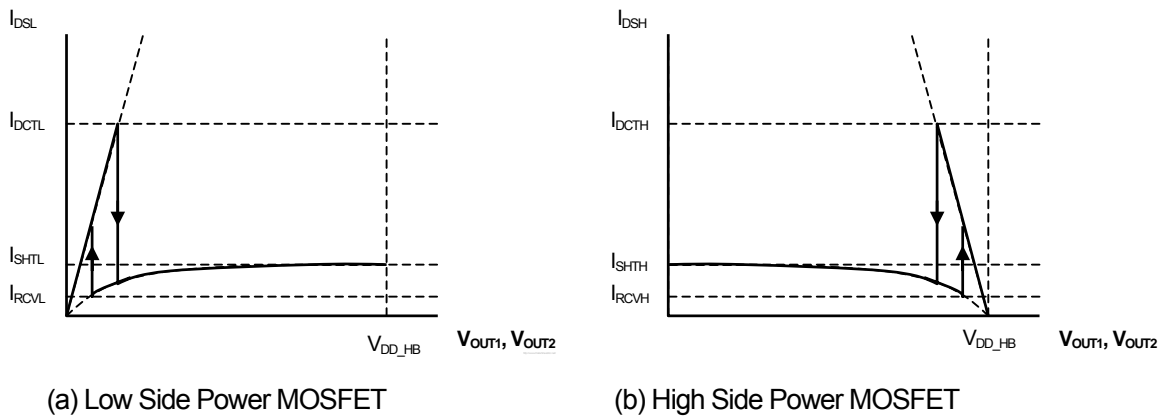

Fig. 1. Output Rise/Fall Time, Rise/Fall Delay Time



(a) Low Side Power MOSFET

(b) High Side Power MOSFET

Fig. 2. Output Current Limit Circuit

## ■ Power Dissipation vs. Ambient Temperature

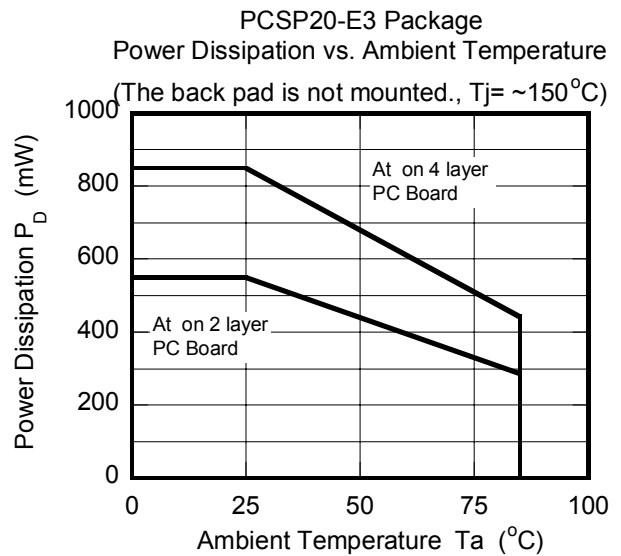
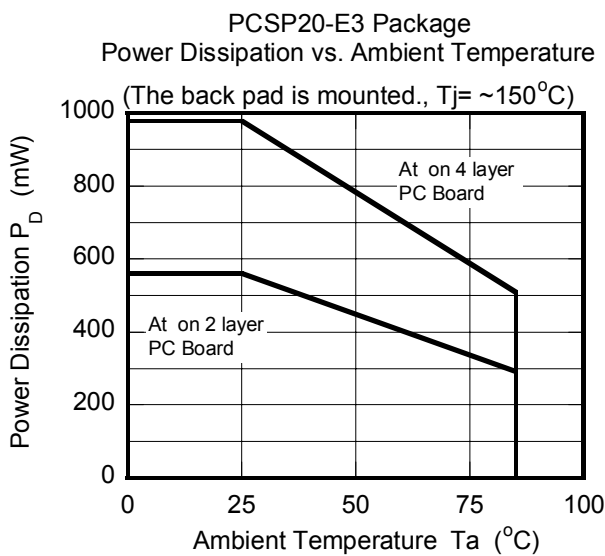

## APPLICATION EXAMPLE

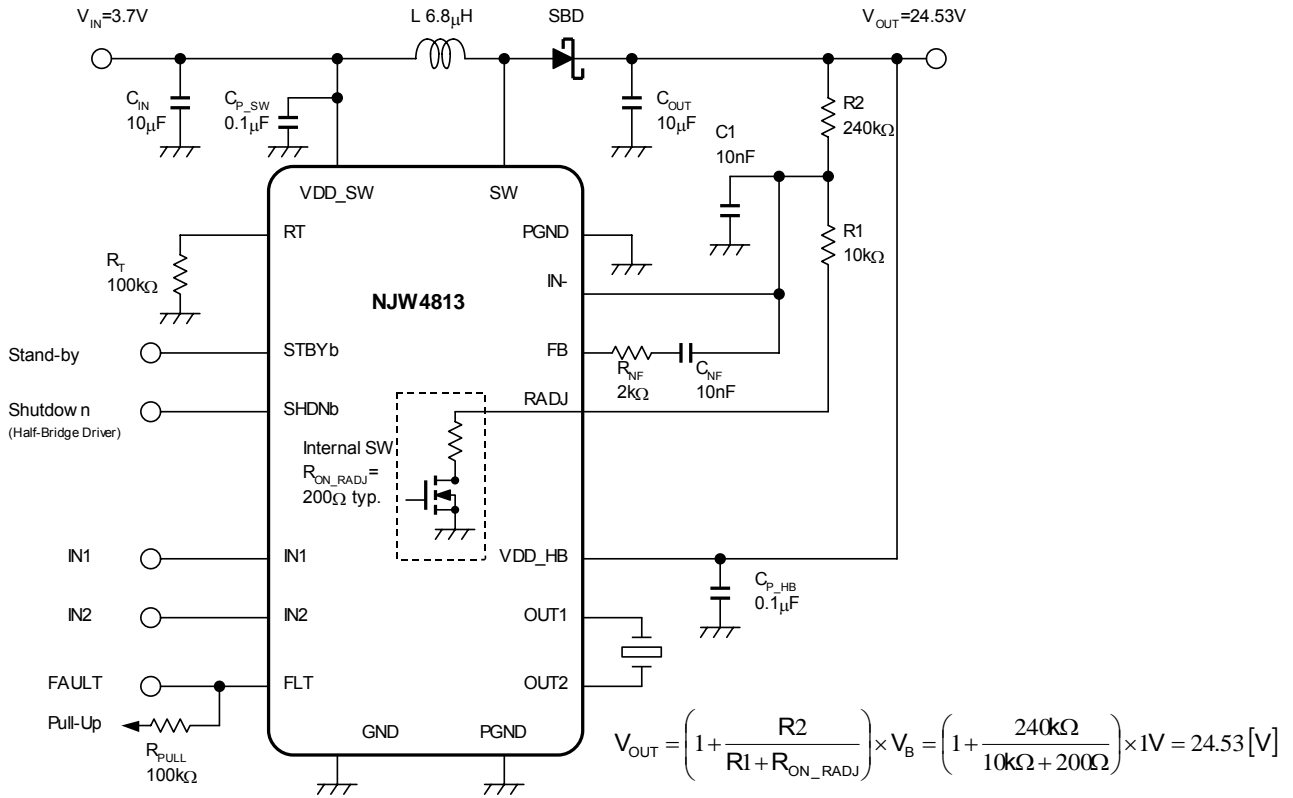

## MEMO

**[CAUTION]**

The specifications on this databook are only given for information, without any guarantee as regards either mistakes or omissions. The application circuits in this databook are described only to show representative usages of the product and not intended for the guarantee or permission of any right including the industrial rights.