

# SMD Transient Voltage Suppressor



## TV30C5V0-G Thru TV30C171-G

Working Peak Reverse Voltage: 5.0 - 170 Volts

Power Dissipation: 3000 Watts

RoHS Device



### Features

Ideal for surface mount applications

Easy pick and place

Plastic package has Underwriters Lab. flammability classification 94V-0

Typical IR less than 1uA above 10V

Fast reponse time: typically less 1nS for uni-direction, less than 5nS for bi-directiona, from 0 V to BV min.

### Mechanical data

Case: JEDEC DO-214AB molded plastic

Terminals: solderable per MIL-STD-750, method 2026

Polarity: Cathode band denoted

Approx. Weight:0.21 gram

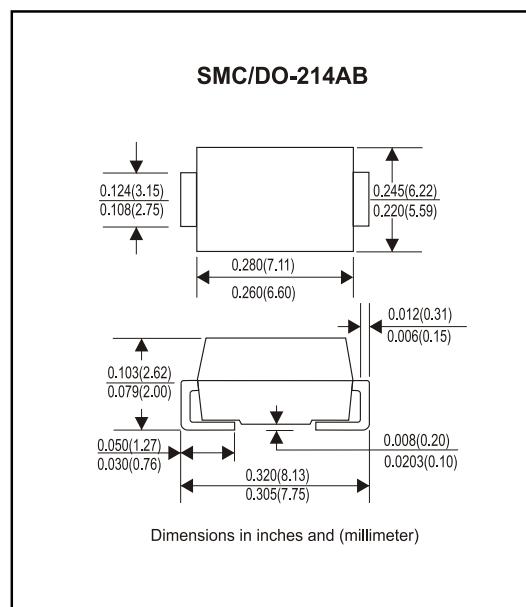

### Maximum Ratings and Electrical Characteristics

Rating at 25°C ambient temperature unless otherwise specified.  
Single phase, half wave, 60Hz, resistive or inductive load.  
For capacitive load, derate current by 20%

Characteristics	Symbol	Value	Units
Peak Power Dissipation on 10/1000uS Waveform (Note 1, Fig. 1)	PPPM	3000	Watts
Peak Pulse Current of on 10/1000uS Waveform (Note 1, Fig. 3)	IPPM	See Table 1	A
Steady State Power Dissipation at TL=75°C (Note 2)	PM(AV)	5.0	Watts
Peak Forward Surge Current, 8.3mS Single Half Sine-Wave Superimposed on Rated Load, Uni-Directional Only (Note 3)	IFSM	250	A
Maximum Instantaneous Forward Voltage at 100A for Uni-Directional only (Note 3 & 4)	VF	3.5/5.0	Volts
Max. Operation Junction Temperature	Tj	150	°C
Storage Temperature Range	TSTG	-55 to +150	°C

Note: 1. Non-Repetitive Current Pulse, per Fig. 3 and Derated above TA=25°C, per Fig. 2.

2. Mounted on 8.0x8.0 mm<sup>2</sup> Copper Pads to Each Terminal.

3. Measured on 8.3 mS Single Half Sine-Wave or Equivalent Square Wave, Duty Cycle=4 Pulse per Minute Maximum.

## Rating and Characteristic Curves (TV30C5V0-G Thru TV30C171-G)

Fig. 1 - Reverse Characteristics

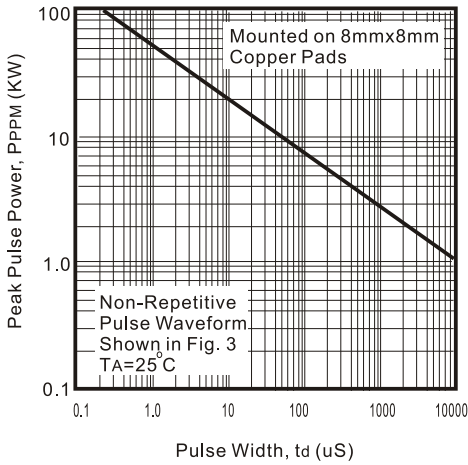

Fig. 2 - Pulse Derating Curve

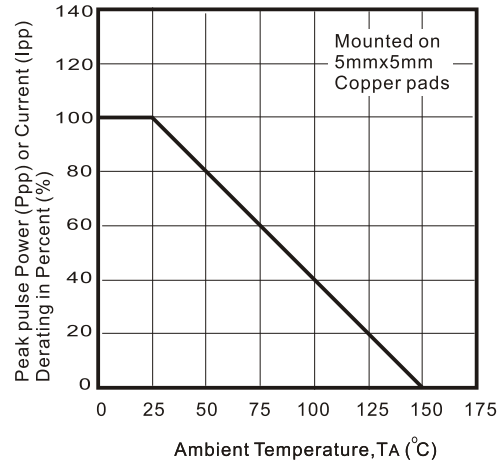

Fig. 3 - Pulse Waveform

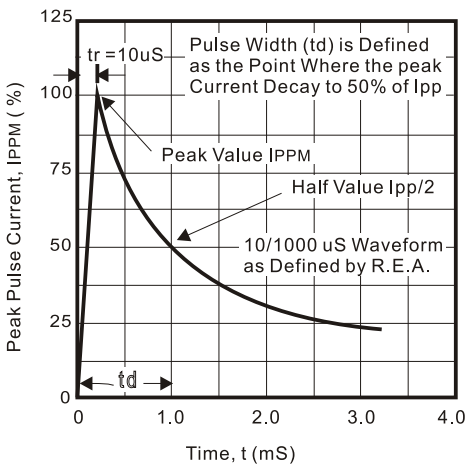

Fig. 4 - Typical Junction Capacitance

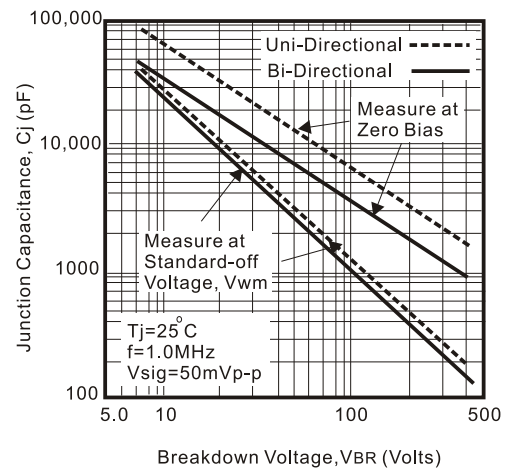

Fig. 5 - Steady State Power Derating Curve

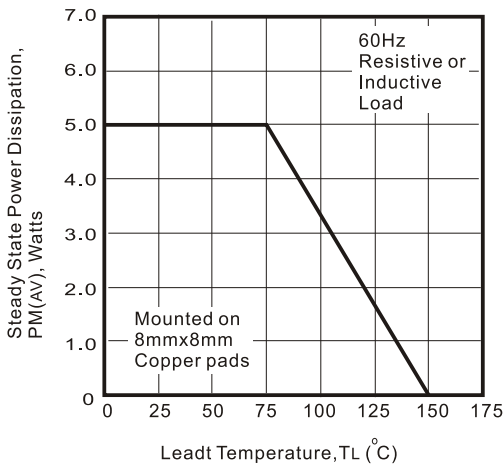
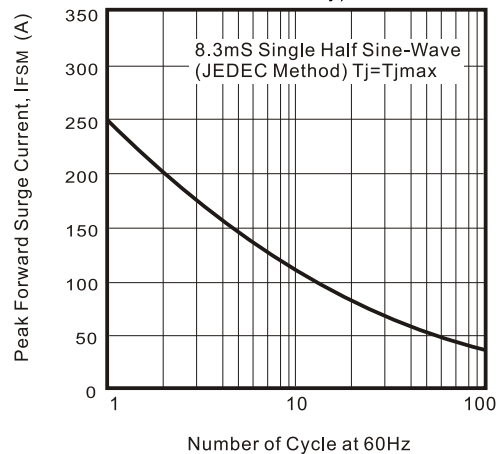

Fig. 6 - Maximum Non-Repetitive Peak Forward Surge Current (Uni-Directional Only)



# SMD Transient Voltage Suppressor



SMB Diodes Specialist

**Table 1. Specification**

Part No	Absolute Maximum Rating( $T_a=25^{\circ}\text{C}$ )					Electrical Characteristic( $T_a=25^{\circ}\text{C}$ )				
	$V_{RWM}$	$V_{BR}$ Min.	$V_{BR}$ Max.	$I_T$	$I_{FSM}$	Max $V_c$	$I_R@V_{RWM}$	Marking Code.		
	(V)	(V)	(V)	(mA)	(A)@8.3ms	(V)	$I_{PP}(A)$	( $\mu A$ )	UNI	BI
TV30C5V0K(B)-G	5.00	6.40	7.55	10	250	9.6	312.5	1000	HDD	IDD
TV30C5V0J(B)-G	5.00	6.40	7.25	10	250	9.2	326.0	1000	HDE	IDE
TV30C6V0K(B)-G	6.00	6.67	8.45	10	250	11.4	263.2	1000	HDF	IDF
TV30C6V0J(B)-G	6.00	6.67	7.67	10	250	10.3	291.3	1000	HDG	IDG
TV30C6V5K(B)-G	6.50	7.22	9.14	10	250	12.3	243.9	500	HDH	IDH
TV30C6V5J(B)-G	6.50	7.22	8.30	10	250	11.2	267.9	500	HDK	IDK
TV30C7V0K(B)-G	7.00	7.78	9.86	1	250	13.3	225.6	200	HDL	IDL
TV30C7V0J(B)-G	7.00	7.78	8.95	1	250	12.0	250.0	200	HDM	IDM
TV30C7V5K(B)-G	7.50	8.33	10.67	1	250	14.3	209.8	100	HDN	IDN
TV30C7V5J(B)-G	7.50	8.33	9.58	1	250	12.9	232.6	100	HDP	IDP
TV30C8V0K(B)-G	8.00	8.89	11.30	1	250	15.0	200.0	50	HDQ	IDQ
TV30C8V0J(B)-G	8.00	8.89	10.23	1	250	13.6	220.6	50	HDR	IDR
TV30C8V5K(B)-G	8.55	9.44	11.9	1	250	15.9	188.8	25	HDS	IDS
TV30C8V5J(B)-G	8.55	9.44	10.8	1	250	14.4	208.4	25	HDT	IDT
TV30C9V0K(B)-G	9.00	10.0	12.6	1	250	16.9	177.4	10	HDU	IDU
TV30C9V0J(B)-G	9.00	10.0	11.5	1	250	15.4	194.8	10	HDV	IDV
TV30C100K(B)-G	10.0	11.1	14.1	1	250	18.8	159.6	5	HDW	IDW
TV30C100J(B)-G	10.0	11.1	12.8	1	250	17.0	176.4	5	HDX	IDX
TV30C110K(B)-G	11.0	12.2	15.4	1	250	20.1	149.2	5	HDY	IDY
TV30C110J(B)-G	11.0	12.2	14.0	1	250	18.2	184.8	5	HDZ	IDZ
TV30C120K(B)-G	12.0	13.3	16.9	1	250	19.9	136.4	5	HED	IED
TV30C120J(B)-G	12.0	13.3	15.3	1	250	19.9	150.6	5	HEE	IEE
TV30C130K(B)-G	13.0	14.4	18.2	1	250	23.8	126.0	5	HEF	IEF
TV30C130J(B)-G	13.0	14.4	16.5	1	250	21.5	139.4	5	HEG	IEG
TV30C140K(B)-G	14.0	15.6	19.8	1	250	25.8	116.2	5	HEH	IEH
TV30C140J(B)-G	14.0	15.6	17.9	1	250	23.2	129.4	5	HEK	IEK
TV30C150K(B)-G	15.0	16.7	21.1	1	250	26.9	111.6	5	HEL	IEL
TV30C150J(B)-G	15.0	16.7	19.2	1	250	24.4	123.0	5	HEM	IEM
TV30C160K(B)-G	16.0	17.8	22.6	1	250	28.8	104.2	5	HEN	IEN
TV30C160J(B)-G	16.0	17.8	20.5	1	250	26.0	115.4	5	HEP	IEP
TV30C170K(B)-G	17.0	18.9	23.9	1	250	30.5	98.4	5	HEQ	IEQ
TV30C170J(B)-G	17.0	18.9	21.7	1	250	27.6	106.6	5	HER	IER
TV30C180K(B)-G	18.0	20.0	25.3	1	250	32.2	93.2	5	HES	IES
TV30C180J(B)-G	18.0	20.0	23.3	1	250	29.2	102.8	5	HET	IET
TV30C200K(B)-G	20.0	22.2	28.1	1	250	35.8	83.8	5	HEU	IEU
TV30C200J(B)-G	20.0	22.2	25.5	1	250	32.4	92.6	5	HEV	IEV
TV30C220K(B)-G	22.0	24.4	30.9	1	250	39.4	76.2	5	HEW	IEW
TV30C220J(B)-G	22.0	24.4	28.0	1	250	35.5	84.4	5	HEX	IEX
TV30C240K(B)-G	24.0	26.7	33.8	1	250	43.0	69.8	5	HEY	IEY
TV30C240J(B)-G	24.0	26.7	30.7	1	250	38.9	77.2	5	HEZ	IEZ
TV30C260K(B)-G	26.0	28.9	36.6	1	250	46.6	64.4	5	HFD	IFD
TV30C260J(B)-G	26.0	28.9	33.2	1	250	42.1	71.2	5	HFE	IFE
TV30C280K(B)-G	28.0	31.1	39.4	1	250	50.0	60.0	5	HFF	IFF
TV30C280J(B)-G	28.0	31.1	35.8	1	250	45.4	66.0	5	HFG	IFG
TV30C300K(B)-G	30.0	33.3	42.2	1	250	53.5	56.0	5	HFH	IFH
TV30C300J(B)-G	30.0	33.3	38.3	1	250	48.4	62.0	5	HFK	IFK
TV30C330K(B)-G	33.0	36.7	46.5	1	250	59.0	50.4	5	HFL	IFL
TV30C330J(B)-G	33.0	36.7	42.2	1	250	53.3	56.2	5	HFM	IFM
TV30C360K(B)-G	36.0	40.0	50.7	1	250	64.3	46.6	5	HFN	IFN
TV30C360J(B)-G	36.0	40.0	46.0	1	250	58.1	51.6	5	HFP	IFP
TV30C400K(B)-G	40.0	44.4	56.3	1	250	71.4	42.0	5	HFQ	IFQ
TV30C400J(B)-G	40.0	44.4	51.1	1	250	64.5	46.4	5	HFR	IFR
TV30C430K(B)-G	43.0	47.8	60.5	1	250	76.7	39.2	5	HFS	IFS
TV30C430J(B)-G	43.0	47.8	54.9	1	250	69.4	43.2	5	HFT	IFT
TV30C450K(B)-G	45.0	50.0	63.3	1	250	80.3	37.4	5	HFU	IFU
TV30C450J(B)-G	45.0	50.0	57.5	1	250	72.7	41.2	5	HFV	IFV

Rev. A

# SMD Transient Voltage Suppressor



Part No	Absolute Maximum Rating(Ta=25°C)					Electrical Characteristic(Ta=25°C)				
	V <sub>RWM</sub>	V <sub>BR</sub> Min.	V <sub>BR</sub> Max.	I <sub>T</sub>	I <sub>FSM</sub>	Max V <sub>c</sub>	I <sub>R@V<sub>RWM</sub></sub>	Marking Code.		
	(V)	(V)	(V)	(mA)	(A)@8.3ms	(V)	I <sub>PP</sub> (A)	(uA)	UNI	BI
TV30C480K(B)-G	48.0	53.3	67.5	1	250	85.5	35.0	5	HFV	IFV
TV30C480J(B)-G	48.0	53.3	61.3	1	250	77.4	38.8	5	HFX	IFX
TV30C510K(B)-G	51.0	56.7	71.8	1	250	91.1	37.0	5	HFY	IFY
TV30C510J(B)-G	51.0	56.7	65.2	1	250	82.4	36.4	5	HFZ	IFZ
TV30C540K(B)-G	54.0	60.0	76.0	1	250	96.3	31.2	5	GGD	IGD
TV30C540J(B)-G	54.0	60.0	69.0	1	250	87.1	34.4	5	GGE	IGE
TV30C580K(B)-G	58.0	64.4	81.6	1	250	103.0	39.2	5	GHF	IGF
TV30C580J(B)-G	58.0	64.4	74.1	1	250	93.6	32.0	5	HGG	IGG
TV30C600K(B)-G	60.0	66.7	84.5	1	250	107.0	28.0	5	HGH	IGH
TV30C600J(B)-G	60.0	66.7	76.7	1	250	96.8	31.0	5	HGK	IGK
TV30C640K(B)-G	64.0	71.1	90.1	1	250	114.0	26.4	5	HGL	IGL
TV30C640J(B)-G	64.0	71.1	81.8	1	250	103.0	29.2	5	HGM	IGM
TV30C700K(B)-G	70.0	77.8	98.6	1	250	125.0	24.0	5	HGN	IGN
TV30C700J(B)-G	70.0	77.8	89.5	1	250	113.0	26.6	5	HGP	IGP
TV30C750K(B)-G	75.0	83.3	105.7	1	250	134.0	22.4	5	HGQ	IGQ
TV30C750J(B)-G	75.0	83.3	95.8	1	250	121.0	24.8	5	HGR	IGR
TV30C780K(B)-G	78.0	86.7	109.8	1	250	139.0	21.6	5	HGS	IGS
TV30C780J(B)-G	78.0	86.7	99.7	1	250	126.0	22.8	5	HGT	IGT
TV30C850K(B)-G	85.0	94.4	119.2	1	250	151.0	19.8	5	HGU	IGU
TV30C850J(B)-G	85.0	94.4	108.2	1	250	137.0	20.8	5	HGV	IGV
TV30C900K(B)-G	90.0	100	126.5	1	250	160.0	18.8	5	HGW	IGW
TV30C900J(B)-G	90.0	100	115.5	1	250	146.0	20.6	5	HGX	IGX
TV30C101K(B)-G	100	111	141.0	1	250	179.0	16.6	5	HGY	IGY
TV30C101J(B)-G	100	111	128.0	1	250	162.0	18.6	5	HGZ	IGZ
TV30C111K(B)-G	110	122	154.5	1	250	196.0	15.4	5	HHD	IHD
TV30C111J(B)-G	110	122	140.5	1	250	177.0	16.8	5	HHE	IHE
TV30C121K(B)-G	120	133	169.0	1	250	214.0	14.0	5	HHF	IHF
TV30C121J(B)-G	120	133	153.0	1	250	193.0	15.6	5	HHG	IHG
TV30C131K(B)-G	130	144	182.5	1	250	231.0	13.0	5	HHH	IHH
TV30C131J(B)-G	130	144	165.5	1	250	209.0	14.4	5	HHK	IHK
TV30C151K(B)-G	150	167	211.5	1	250	268.0	11.2	5	HHL	IHL
TV30C151J(B)-G	150	167	192.5	1	250	243.0	12.4	5	HHM	IHM
TV30C161K(B)-G	160	178	226.0	1	250	287.0	10.4	5	HHN	IHN
TV30C161J(B)-G	160	178	205.0	1	250	259.0	11.6	5	HHP	IHP
TV30C171K(B)-G	170	189	239.5	1	250	304.0	9.8	5	HHQ	IHQ
TV30C171J(B)-G	170	189	217.5	1	250	275.0	11.0	5	HHR	IHR

Note:

- 1) Suffix K denotes 10% tolerance devices, suffix J denotes 5% tolerance devices.
- 2) Suffix B after part number to specify bi-directional devices.
- 3) For bi-directional devices having VR of 10 volts and under, the IR limit is double.