

Automotive dual-line Transil™, transient voltage suppressor (TVS) for CAN bus

Datasheet - production data

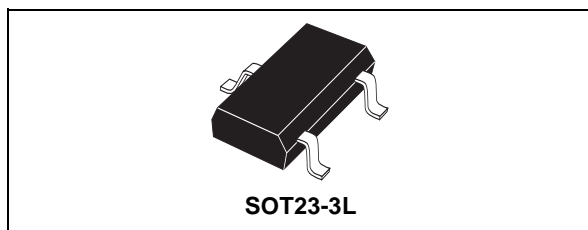

Features

- Dual-line ESD and EOS protection
- Bidirectional device
- Max pulse power: 230 W (8/20 μs)
- Stand-off voltage 24 V
- Low clamping factor V_{CL} / V_{BR}
- Fast response time
- Low leakage current
- Small plastic package
- ECOPACK®2 compliant component
- AEC-Q101 qualified

Benefits

- ESD and EOS protection for CAN transceiver
- SOT23 package for space saving on high density printed circuit board
- Transil diodes providing high overvoltage protection by clamping action and instantaneous response to transient overvoltage

Complies with the following standards

- ISO 10605 - C = 150 pF, R = 330 Ω :
 - 30 kV (air discharge)
 - 30 kV (contact discharge)
- ISO 10605 - C = 330 pF, R = 330 Ω :
 - 30 kV (air discharge)
 - 30 kV (contact discharge)
- ISO 7637-3:
 - Pulse 3a: $V_s = -150$ V
 - Pulse 3b: $V_s = +100$ V

Application

Automotive controller area network (CAN) bus lines where electrostatic discharge and other transients must be suppressed.

Description

The ESDCAN01-2BLY is a dual-line Transil specifically designed for the protection of the automotive CAN bus lines against electrostatic discharge (ESD).

Figure 1. Functional diagram

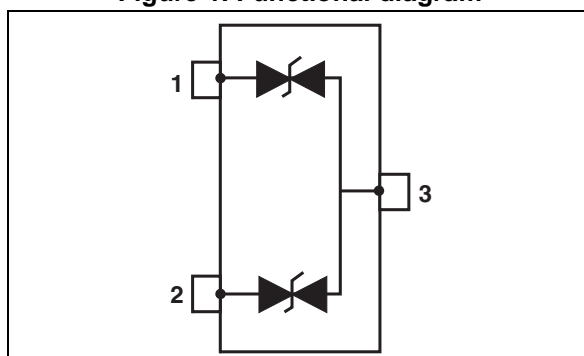

TM: Transil is a trademark of STMicroelectronics

1 Characteristics

Table 1. Absolute maximum ratings ($T_{amb} = 25^{\circ}\text{C}$)

Symbol	Parameter		Value	Unit
V_{PP}	Electrostatic discharge capability	ISO 10605 - C = 150 pF, R = 330 Ω :		kV
		Contact discharge	30	
		Air discharge	30	
		ISO 10605 - C = 330 pF, R = 330 Ω :		
		Contact discharge	30	
		Air discharge	30	
		HBM MIL STD 883	8	
P_{PP}	Peak pulse power dissipation (8/20 μs)	$T_j \text{ initial} = T_{amb}$	230	W
I_{PP}	Peak pulse current (8/20 μs)		5.5	A
T_{op}	Operating junction temperature range		-55 to +150	$^{\circ}\text{C}$
T_{stg}	Storage temperature range		-55 to +150	$^{\circ}\text{C}$

Figure 2. Electrical characteristics (definitions)

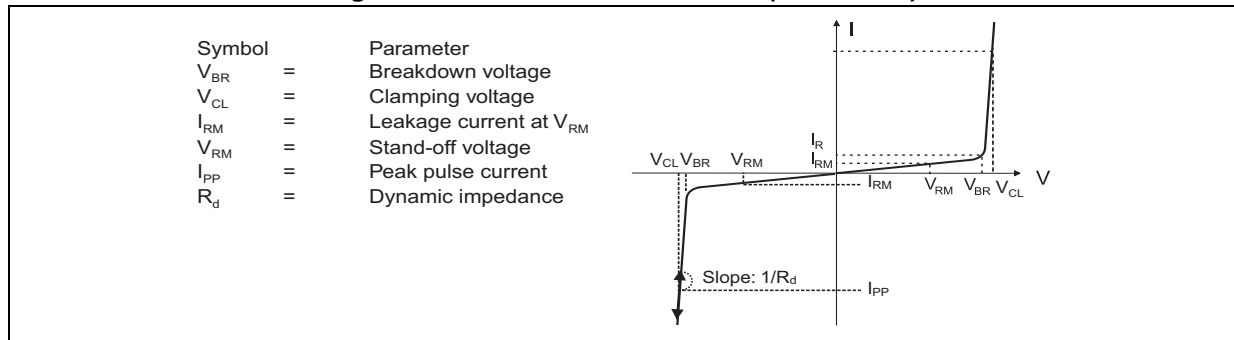

Table 2. Electrical characteristics (values, $T_{amb} = 25^{\circ}\text{C}$)

Symbol	Test conditions	Min.	Typ.	Max.	Unit
V_{RM}	Stand-off voltage			24	V
V_{BR}	$I_R = 1 \text{ mA}$	25		30	V
I_{RM}	$V_{RM} = 24 \text{ V}$			100	nA
V_{CL}	Pulse ISO 7637-3 Pulse 3b			35	V
V_{CL}	Pulse ISO 7637-3 Pulse 3a	-35			V
V_{CL}	$I_{PP} = 5 \text{ A}, 8/20\mu\text{s}$			40	V
$\alpha T^{(1)}$	Voltage temperature coefficient			9	$10^{-4}/^{\circ}\text{C}$
C	$V_R = 0 \text{ V DC}, F = 1 \text{ MHz}$			30	pF

1. $\Delta V_{BR} = \alpha \times T \times (T_{amb} - 25) \times V_{BR}(25^{\circ}\text{C})$

Figure 3. Peak pulse power versus initial junction temperature (maximum values)

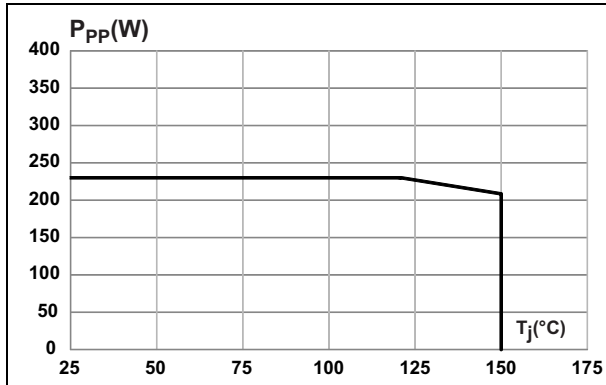

Figure 4. Junction capacitance versus reverse voltage applied (typical values)

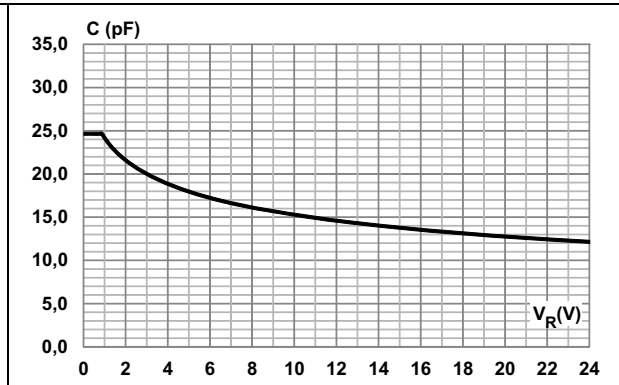

Figure 5. Peak pulse power versus exponential pulse (maximum values)

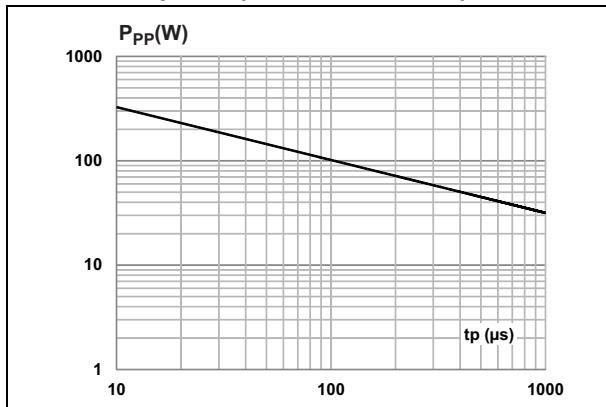

Figure 6. Clamping voltage versus peak pulse current (typical values)

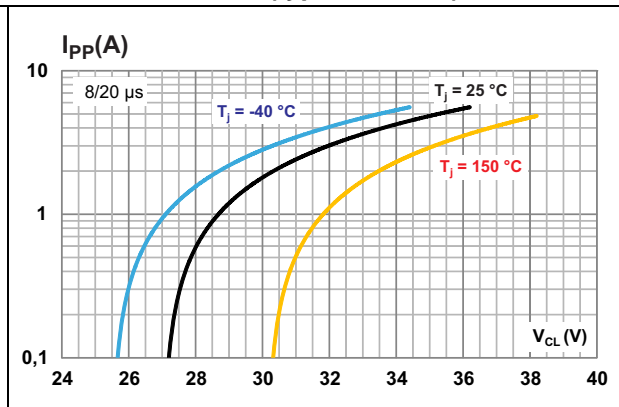

Figure 7. Leakage current versus junction temperature (typical values)

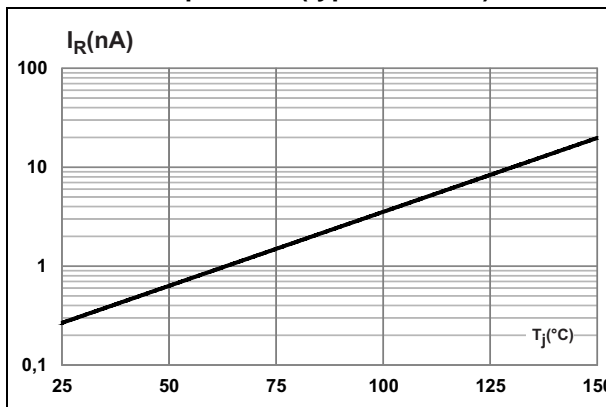

Figure 8. S21 attenuation

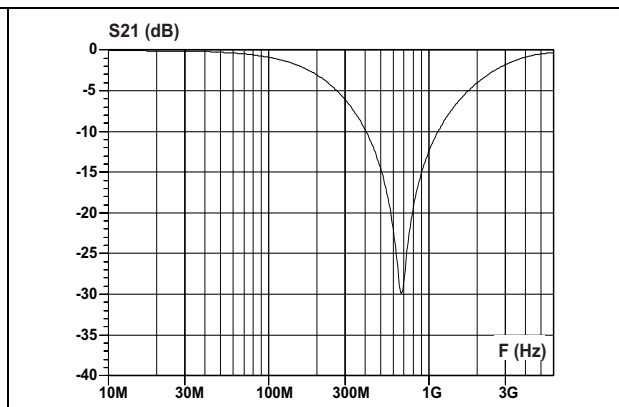

Figure 9. ESD response to ISO 10605 - C = 150 pF, R = 330 Ω (+8 kV contact)

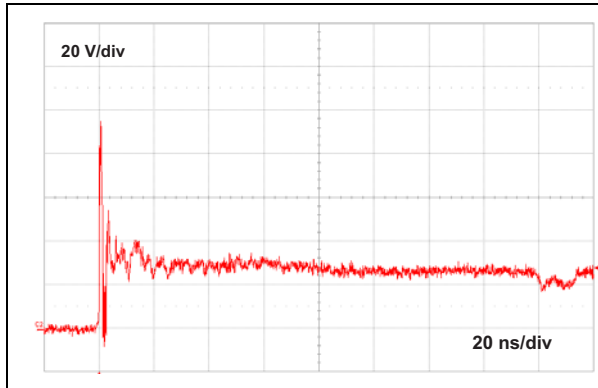

Figure 10. ESD response to ISO 10605 - C = 150 pF, R = 330 Ω (-8 kV contact)

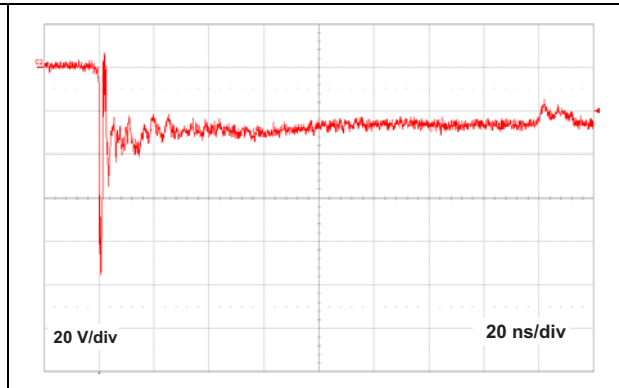

Figure 11. Response to ISO 7637-3 Pulse 3a (Us = -150 V)

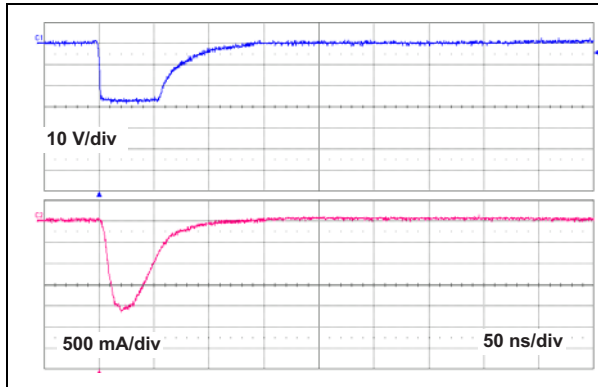

Figure 12. Response to ISO 7637-3 Pulse 3b (Us = +100 V)

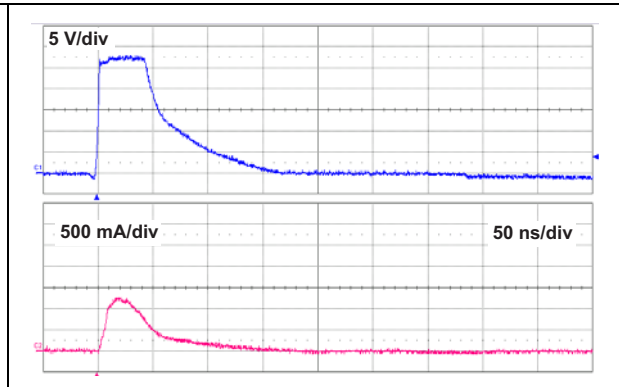
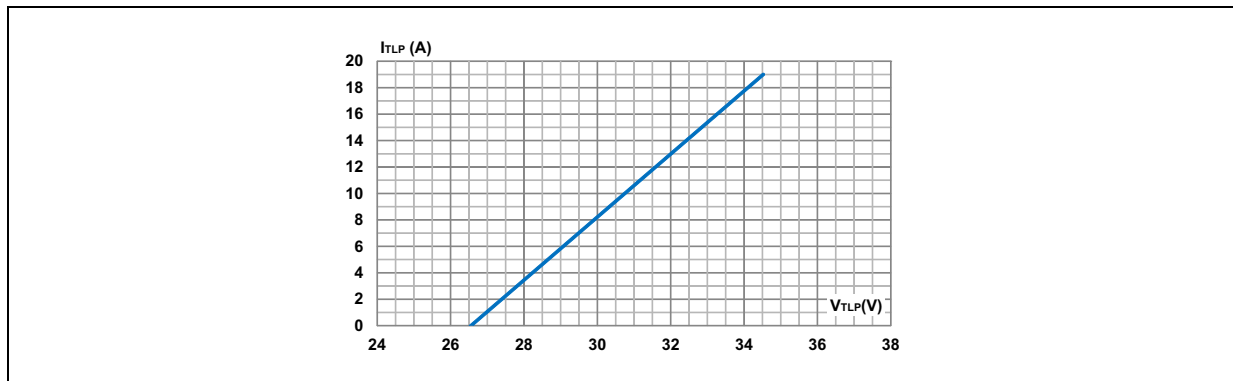

Figure 13. TLP measurements



2 Application and design guidelines

More information is available in the ST Application note AN2689 “Protection of automotive electronics from electrical hazards, guidelines for design and component selection”.

3 Package information

- Epoxy meets UL94, V0
- Lead-free packages

In order to meet environmental requirements, ST offers these devices in different grades of ECOPACK[®] packages, depending on their level of environmental compliance. ECOPACK[®] specifications, grade definitions and product status are available at: www.st.com. ECOPACK[®] is an ST trademark.

Figure 14. SOT23-3L dimension definitions

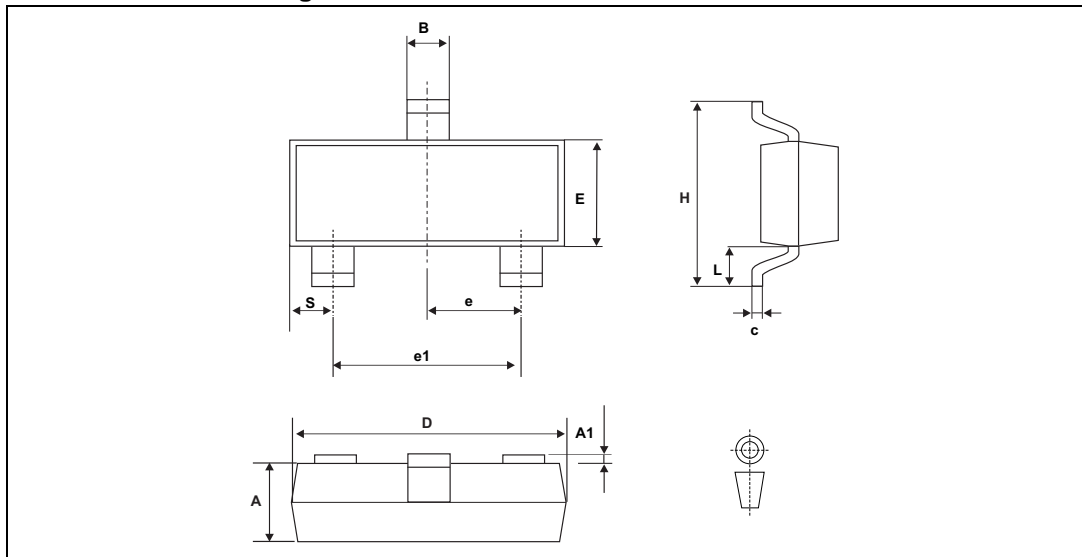
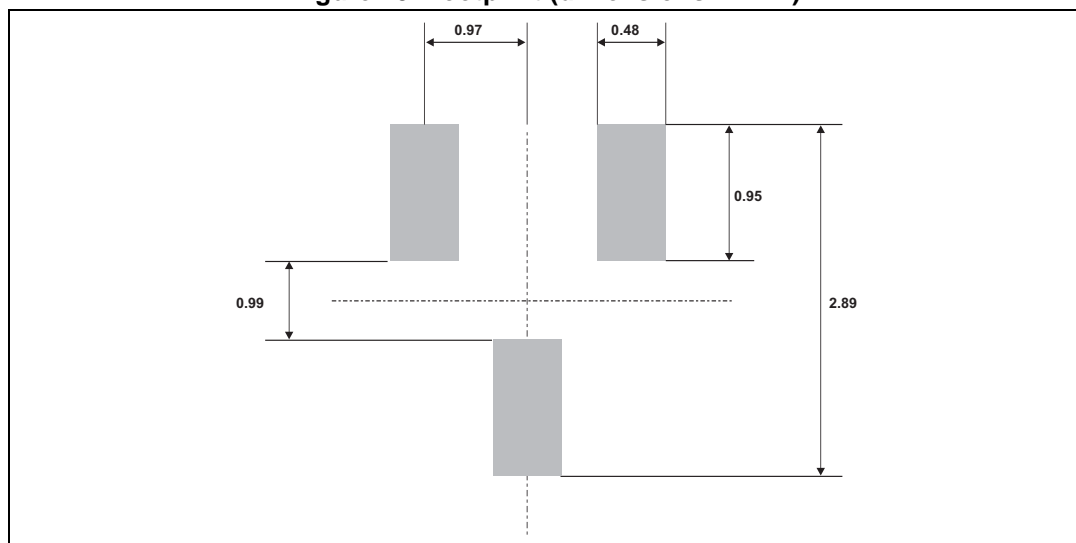

Table 3. SOT23-3L dimension values

Ref.	Dimensions			
	Millimeters		Inches	
	Min.	Max.	Min.	Max.
A	0.89	1.4	0.035	0.055
A1	0	0.1	0	0.004
B	0.3	0.51	0.012	0.02
C	0.085	0.18	0.003	0.007
D	2.75	3.04	0.108	0.12
e	0.85	1.05	0.033	0.041
e1	1.7	2.1	0.067	0.083
E	1.2	1.75	0.047	0.069
H	2.1	3.00	0.083	0.118
L	0.6 typ.		0.024 typ.	
S	0.35	0.65	0.013	0.026

Figure 15. Footprint (dimensions in mm)



4 Ordering information

Figure 16. Ordering information scheme

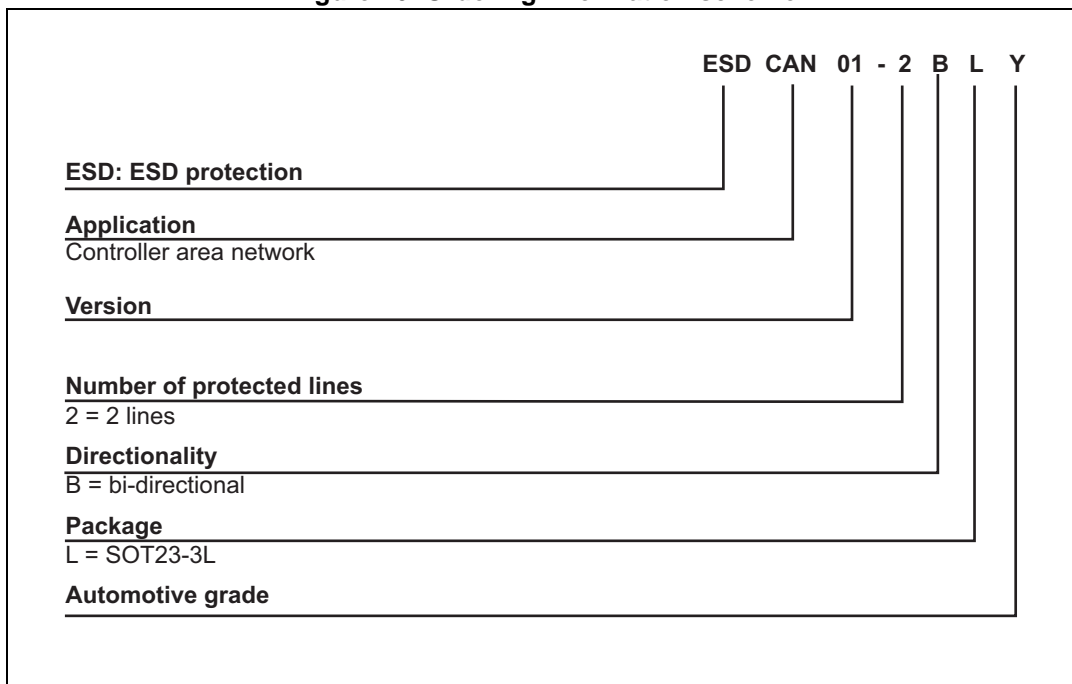

Table 4. Ordering information

Order code	Marking	Package	Weight	Base qty	Delivery mode
ESDCAN01-2BLY	EN24	SOT-23	9.7 mg	3000	Tape and reel

5 Revision history

Table 5. Document revision history

Date	Revision	Changes
23-Jun-2014	1	First issue.

Please Read Carefully:

Information in this document is provided solely in connection with ST products. STMicroelectronics NV and its subsidiaries ("ST") reserve the right to make changes, corrections, modifications or improvements, to this document, and the products and services described herein at any time, without notice.

All ST products are sold pursuant to ST's terms and conditions of sale.

Purchasers are solely responsible for the choice, selection and use of the ST products and services described herein, and ST assumes no liability whatsoever relating to the choice, selection or use of the ST products and services described herein.

No license, express or implied, by estoppel or otherwise, to any intellectual property rights is granted under this document. If any part of this document refers to any third party products or services it shall not be deemed a license grant by ST for the use of such third party products or services, or any intellectual property contained therein or considered as a warranty covering the use in any manner whatsoever of such third party products or services or any intellectual property contained therein.

UNLESS OTHERWISE SET FORTH IN ST'S TERMS AND CONDITIONS OF SALE ST DISCLAIMS ANY EXPRESS OR IMPLIED WARRANTY WITH RESPECT TO THE USE AND/OR SALE OF ST PRODUCTS INCLUDING WITHOUT LIMITATION IMPLIED WARRANTIES OF MERCHANTABILITY, FITNESS FOR A PARTICULAR PURPOSE (AND THEIR EQUIVALENTS UNDER THE LAWS OF ANY JURISDICTION), OR INFRINGEMENT OF ANY PATENT, COPYRIGHT OR OTHER INTELLECTUAL PROPERTY RIGHT.

ST PRODUCTS ARE NOT DESIGNED OR AUTHORIZED FOR USE IN: (A) SAFETY CRITICAL APPLICATIONS SUCH AS LIFE SUPPORTING, ACTIVE IMPLANTED DEVICES OR SYSTEMS WITH PRODUCT FUNCTIONAL SAFETY REQUIREMENTS; (B) AERONAUTIC APPLICATIONS; (C) AUTOMOTIVE APPLICATIONS OR ENVIRONMENTS, AND/OR (D) AEROSPACE APPLICATIONS OR ENVIRONMENTS. WHERE ST PRODUCTS ARE NOT DESIGNED FOR SUCH USE, THE PURCHASER SHALL USE PRODUCTS AT PURCHASER'S SOLE RISK, EVEN IF ST HAS BEEN INFORMED IN WRITING OF SUCH USAGE, UNLESS A PRODUCT IS EXPRESSLY DESIGNATED BY ST AS BEING INTENDED FOR "AUTOMOTIVE, AUTOMOTIVE SAFETY OR MEDICAL" INDUSTRY DOMAINS ACCORDING TO ST PRODUCT DESIGN SPECIFICATIONS. PRODUCTS FORMALLY ESCC, QML OR JAN QUALIFIED ARE DEEMED SUITABLE FOR USE IN AEROSPACE BY THE CORRESPONDING GOVERNMENTAL AGENCY.

Resale of ST products with provisions different from the statements and/or technical features set forth in this document shall immediately void any warranty granted by ST for the ST product or service described herein and shall not create or extend in any manner whatsoever, any liability of ST.

ST and the ST logo are trademarks or registered trademarks of ST in various countries.

Information in this document supersedes and replaces all information previously supplied.

The ST logo is a registered trademark of STMicroelectronics. All other names are the property of their respective owners.

© 2014 STMicroelectronics - All rights reserved

STMicroelectronics group of companies

Australia - Belgium - Brazil - Canada - China - Czech Republic - Finland - France - Germany - Hong Kong - India - Israel - Italy - Japan - Malaysia - Malta - Morocco - Philippines - Singapore - Spain - Sweden - Switzerland - United Kingdom - United States of America

www.st.com