

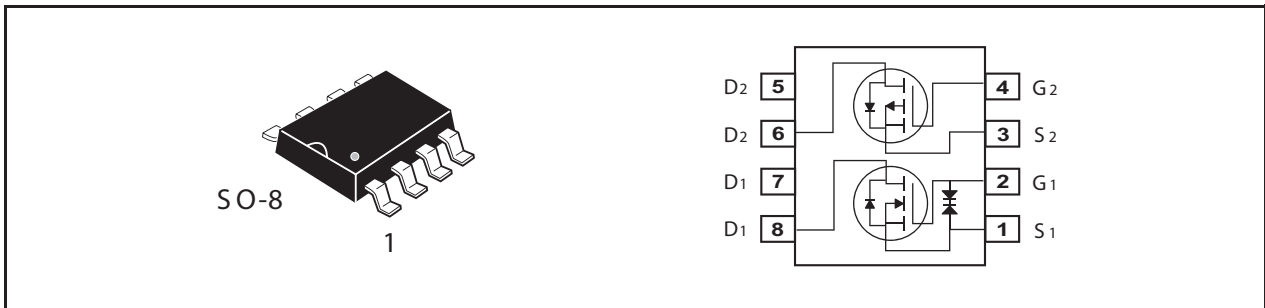

Dual Enhancement Mode Field Effect Transistor (N and P Channel)

PRODUCT SUMMARY (N-Channel)		
V _{DS}	I _D	R _{DS(ON)} (mΩ) Max
30V	6A	35 @ V _{GS} =10V
		55 @ V _{GS} =4.5V

PRODUCT SUMMARY (P-Channel)		
V _{DS}	I _D	R _{DS(ON)} (mΩ) Max
-30V	-4.2A	76 @ V _{GS} =-10V
		138 @ V _{GS} =-4.5V



ABSOLUTE MAXIMUM RATINGS (T_C=25°C unless otherwise noted)

Symbol	Parameter	N-Channel	P-Channel	Units	
V _{DS}	Drain-Source Voltage	30	-30	V	
V _{GS}	Gate-Source Voltage	±20	±20	V	
I _D	Drain Current-Continuous ^a	T _C =25°C	6	-4.2	A
		T _C =70°C	4.8	-3.3	A
I _{DM}	-Pulsed ^b	24	-17	A	
E _{AS}	Single Pulse Avalanche Energy ^d	16	27.5	mJ	
P _D	Maximum Power Dissipation ^a	T _C =25°C	2	W	
		T _C =70°C	1.28	W	
T _J , T _{STG}	Operating Junction and Storage Temperature Range	-55 to 150		°C	

THERMAL CHARACTERISTICS

R _{θJA}	Thermal Resistance, Junction-to-Ambient ^a	62.5	°C/W
------------------	--	------	------

STM8330

Ver 1.0

N-Channel ELECTRICAL CHARACTERISTICS (T_C=25°C unless otherwise noted)

Symbol	Parameter	Conditions	Min	Typ	Max	Units
OFF CHARACTERISTICS						
BV _{DSS}	Drain-Source Breakdown Voltage	V _{GS} =0V, I _D =250μA	30			V
I _{DSS}	Zero Gate Voltage Drain Current	V _{DS} =24V, V _{GS} =0V			1	μA
I _{GSS}	Gate-Body Leakage Current	V _{GS} = ±20V, V _{DS} =0V			±10	μA
ON CHARACTERISTICS						
V _{GS(th)}	Gate Threshold Voltage	V _{DS} =V _{GS} , I _D =250μA	1.0	1.8	3	V
R _{DS(ON)}	Drain-Source On-State Resistance	V _{GS} =10V, I _D =6A		28	35	m ohm
		V _{GS} =4.5V, I _D =4.9A		42	55	m ohm
g _{FS}	Forward Transconductance	V _{DS} =5V, I _D =6A		17		S
DYNAMIC CHARACTERISTICS ^c						
C _{ISS}	Input Capacitance	V _{DS} =15V, V _{GS} =0V f=1.0MHz		440		pF
C _{OSS}	Output Capacitance			77		pF
C _{RSS}	Reverse Transfer Capacitance			53		pF
SWITCHING CHARACTERISTICS ^c						
t _{D(ON)}	Turn-On Delay Time	V _{DD} =15V I _D =1A V _{GS} =10V R _{GEN} = 6 ohm		9.8		ns
t _r	Rise Time			9.8		ns
t _{D(OFF)}	Turn-Off Delay Time			16.5		ns
t _f	Fall Time			7.4		ns
Q _g	Total Gate Charge	V _{DS} =15V, I _D =6A, V _{GS} =10V		7		nC
		V _{DS} =15V, I _D =6A, V _{GS} =4.5V		3.4		nC
Q _{gs}	Gate-Source Charge	V _{DS} =15V, I _D =6A,		1.2		nC
Q _{gd}	Gate-Drain Charge	V _{GS} =10V		1.7		nC
DRAIN-SOURCE DIODE CHARACTERISTICS AND MAXIMUM RATINGS						
V _{SD}	Diode Forward Voltage ^b	V _{GS} =0V, I _S =1A		0.78	1.3	V

Mar, 18, 2010

STM8330

Ver 1.0

P-Channel ELECTRICAL CHARACTERISTICS (T_C=25°C unless otherwise noted)

Symbol	Parameter	Conditions	Min	Typ	Max	Units
OFF CHARACTERISTICS						
BV _{DSS}	Drain-Source Breakdown Voltage	V _{GS} =0V, I _D =-250μA	-30			V
I _{DSS}	Zero Gate Voltage Drain Current	V _{DS} =-24V, V _{GS} =0V			-1	μA
I _{GSS}	Gate-Body Leakage Current	V _{GS} = ±20V, V _{DS} =0V			±100	nA
ON CHARACTERISTICS						
V _{GS(th)}	Gate Threshold Voltage	V _{DS} =V _{GS} , I _D =-250μA	-1.0	-2.0	-3	V
R _{DS(ON)}	Drain-Source On-State Resistance	V _{GS} =-10V, I _D =-4.2A		61	76	m ohm
		V _{GS} =-4.5V, I _D =-3A		106	138	m ohm
g _{FS}	Forward Transconductance	V _{DS} =-5V, I _D =-4.2A		7		S
DYNAMIC CHARACTERISTICS ^c						
C _{ISS}	Input Capacitance	V _{DS} =-15V, V _{GS} =0V f=1.0MHz		428		pF
C _{OSS}	Output Capacitance			95		pF
C _{RSS}	Reverse Transfer Capacitance			75		pF
SWITCHING CHARACTERISTICS ^c						
t _{D(ON)}	Turn-On Delay Time	V _{DD} =-15V I _D =-1A V _{GS} =-10V R _{GEN} = 6 ohm		10		ns
t _r	Rise Time			13.5		ns
t _{D(OFF)}	Turn-Off Delay Time			67		ns
t _f	Fall Time			42		ns
Q _g	Total Gate Charge	V _{DS} =-15V, I _D =-4.2A, V _{GS} =-10V		9.5		nC
		V _{DS} =-15V, I _D =-4.2A, V _{GS} =-4.5V		4.8		nC
Q _{gs}	Gate-Source Charge	V _{DS} =-15V, I _D =-4.2A,		1		nC
Q _{gd}	Gate-Drain Charge	V _{GS} =-10V		3		nC
DRAIN-SOURCE DIODE CHARACTERISTICS AND MAXIMUM RATINGS						
V _{SD}	Diode Forward Voltage ^b	V _{GS} =0V, I _S =-1A		-0.8	-1.3	V
Notes						
a.Surface Mounted on FR4 Board, t ≤ 10sec.						
b.Pulse Test:Pulse Width ≤ 300us, Duty Cycle ≤ 2%.						
c.Guaranteed by design, not subject to production testing.						
d.Starting T _J =25°C, L=0.5mH, V _{DD} = 20V, V _{GS} =10V.(See Figure13)						

Mar, 18, 2010

N-Channel

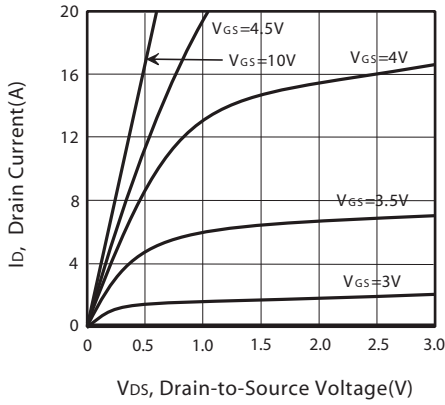

Figure 1. Output Characteristics

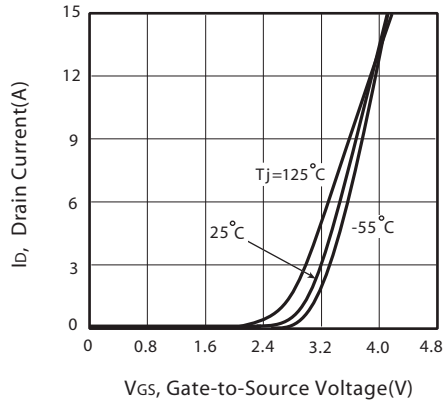

Figure 2. Transfer Characteristics

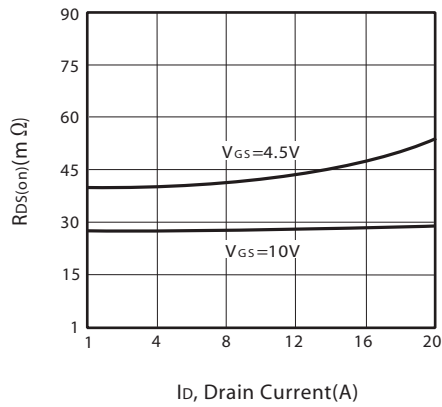

Figure 3. On-Resistance vs. Drain Current and Gate Voltage

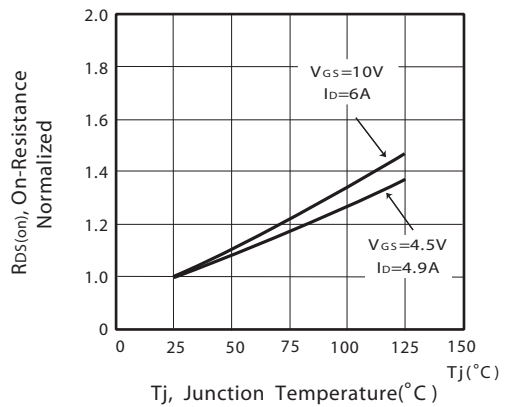

Figure 4. On-Resistance Variation with Drain Current and Temperature

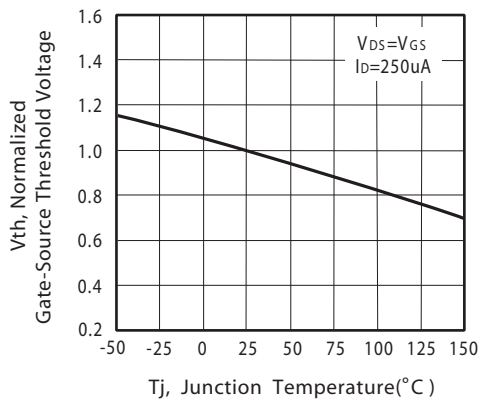

Figure 5. Gate Threshold Variation with Temperature

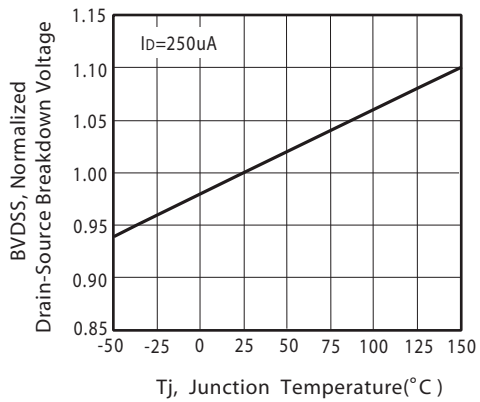

Figure 6. Breakdown Voltage Variation with Temperature

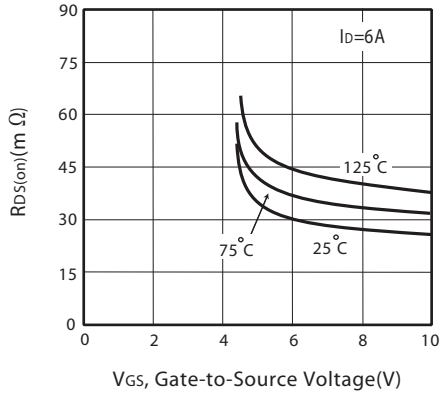

Figure 7. On-Resistance vs. Gate-Source Voltage

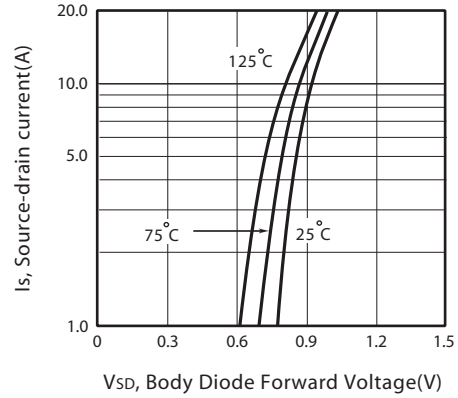

Figure 8. Body Diode Forward Voltage Variation with Source Current

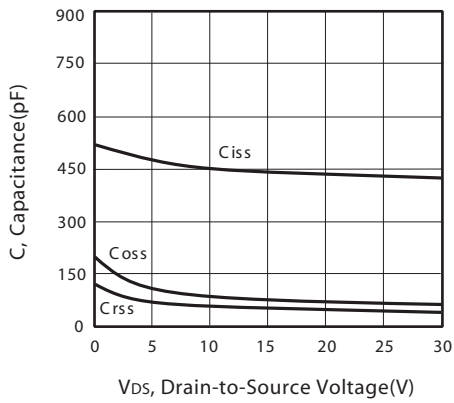

Figure 9. Capacitance

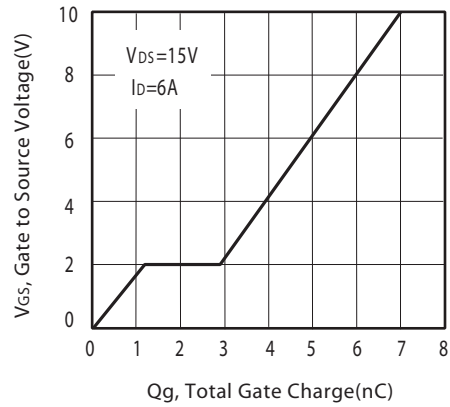

Figure 10. Gate Charge

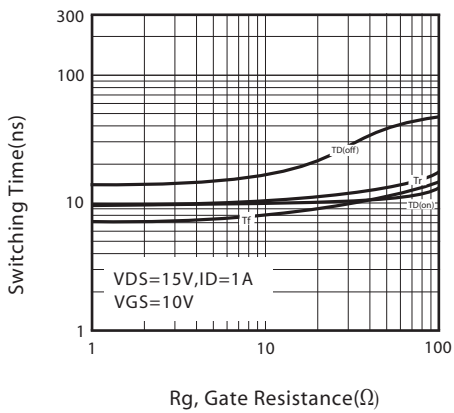

Figure 11. switching characteristics

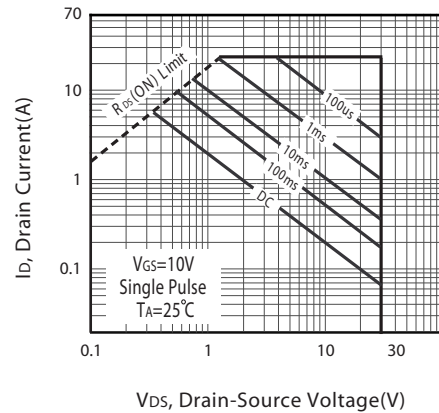
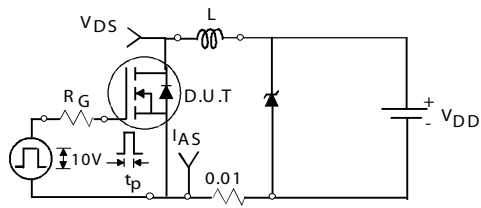
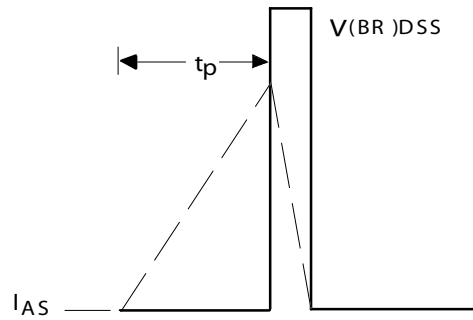

Figure 12. Maximum Safe Operating Area



Unclamped Inductive Test Circuit

Figure 13a.



Unclamped Inductive Waveforms

Figure 13b.

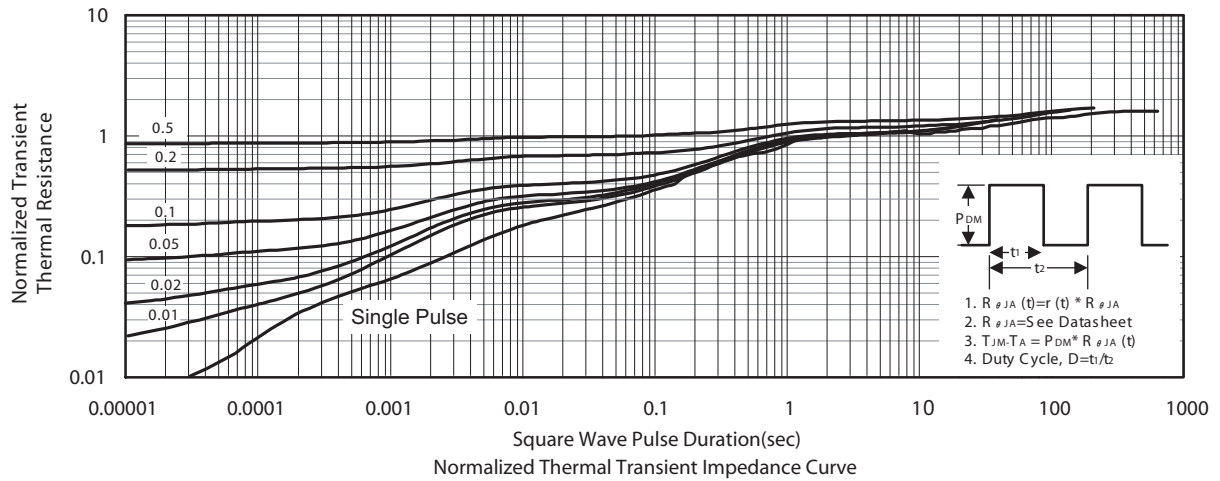

P-Channel

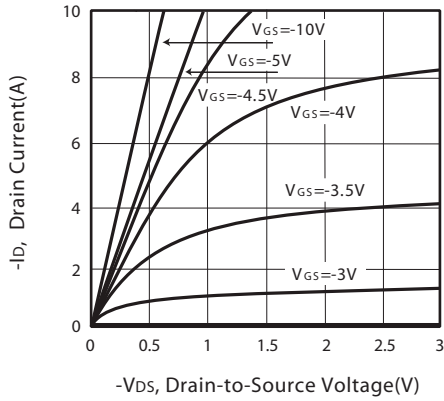

Figure 1. Output Characteristics

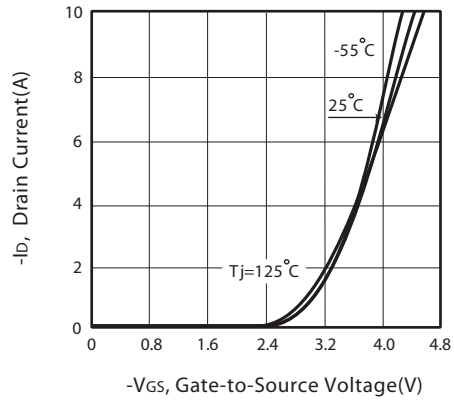

Figure 2. Transfer Characteristics

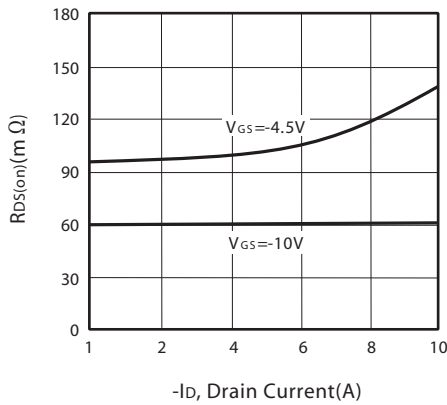

Figure 3. On-Resistance vs. Drain Current and Gate Voltage

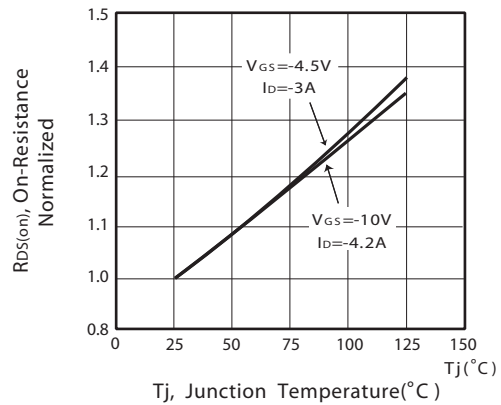

Figure 4. On-Resistance Variation with Drain Current and Temperature

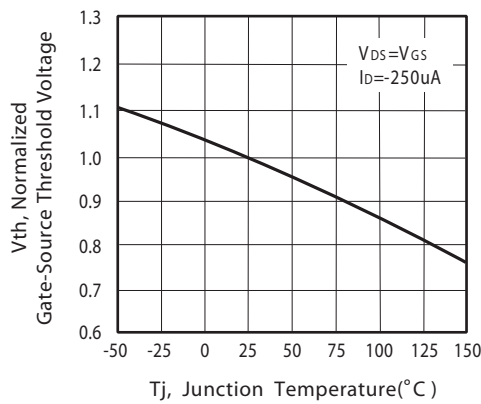

Figure 5. Gate Threshold Variation with Temperature

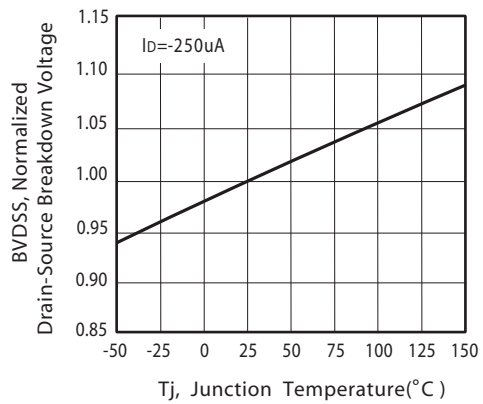

Figure 6. Breakdown Voltage Variation with Temperature

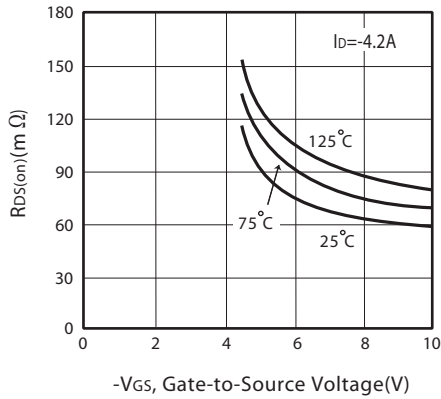

Figure 7. On-Resistance vs. Gate-Source Voltage

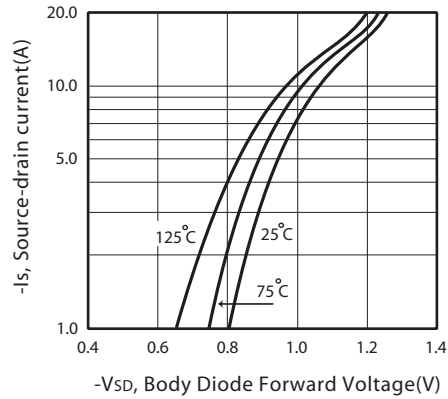

Figure 8. Body Diode Forward Voltage Variation with Source Current

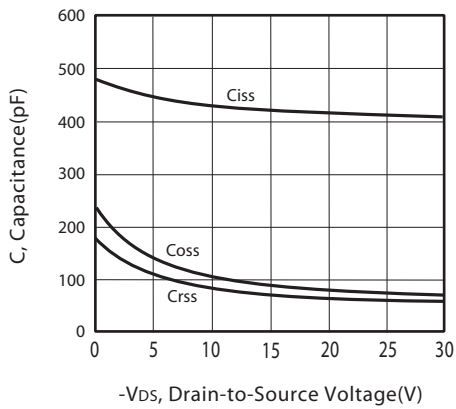

Figure 9. Capacitance

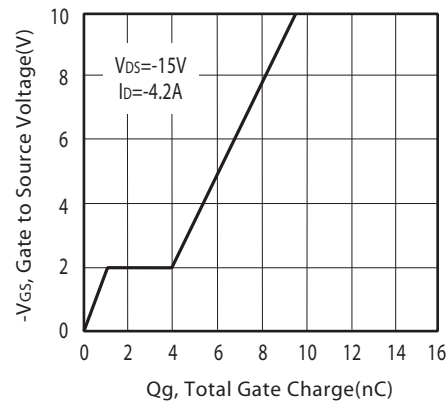

Figure 10. Gate Charge

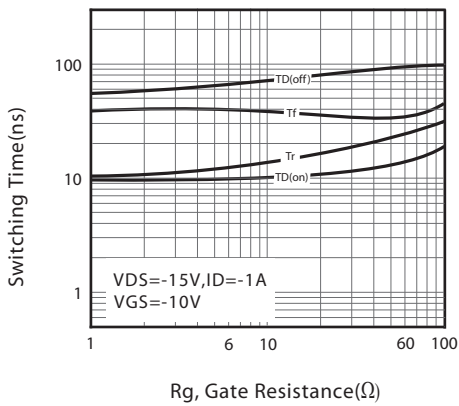

Figure 11. switching characteristics

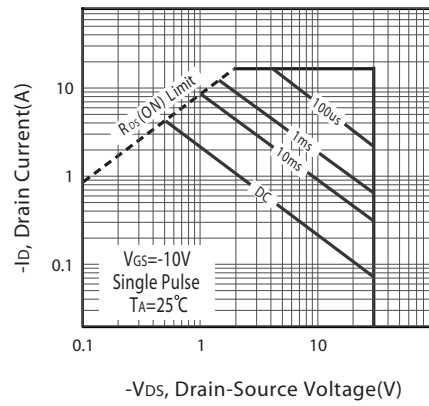
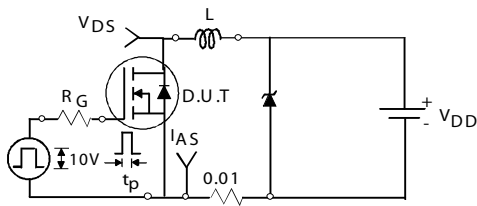
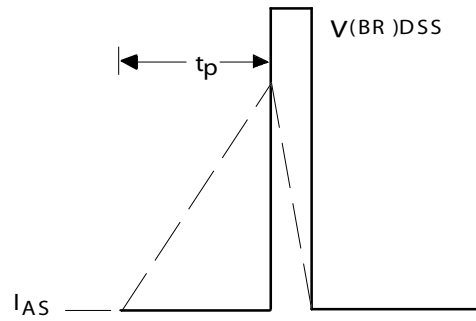

Figure 12. Maximum Safe Operating Area



Unclamped Inductive Test Circuit

Figure 13a.



Unclamped Inductive Waveforms

Figure 13b.

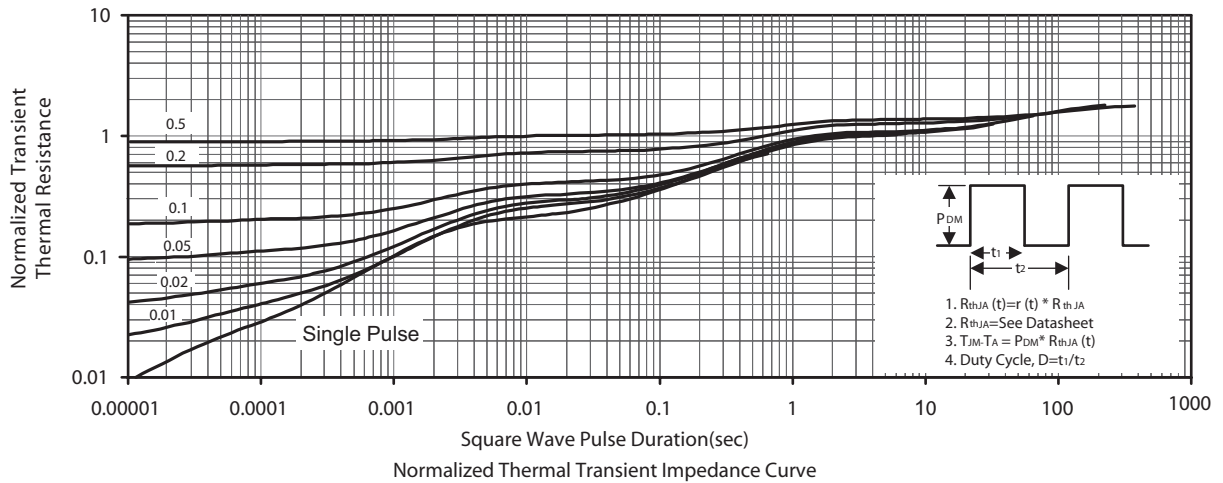

PACKAGE OUTLINE DIMENSIONS

SO-8

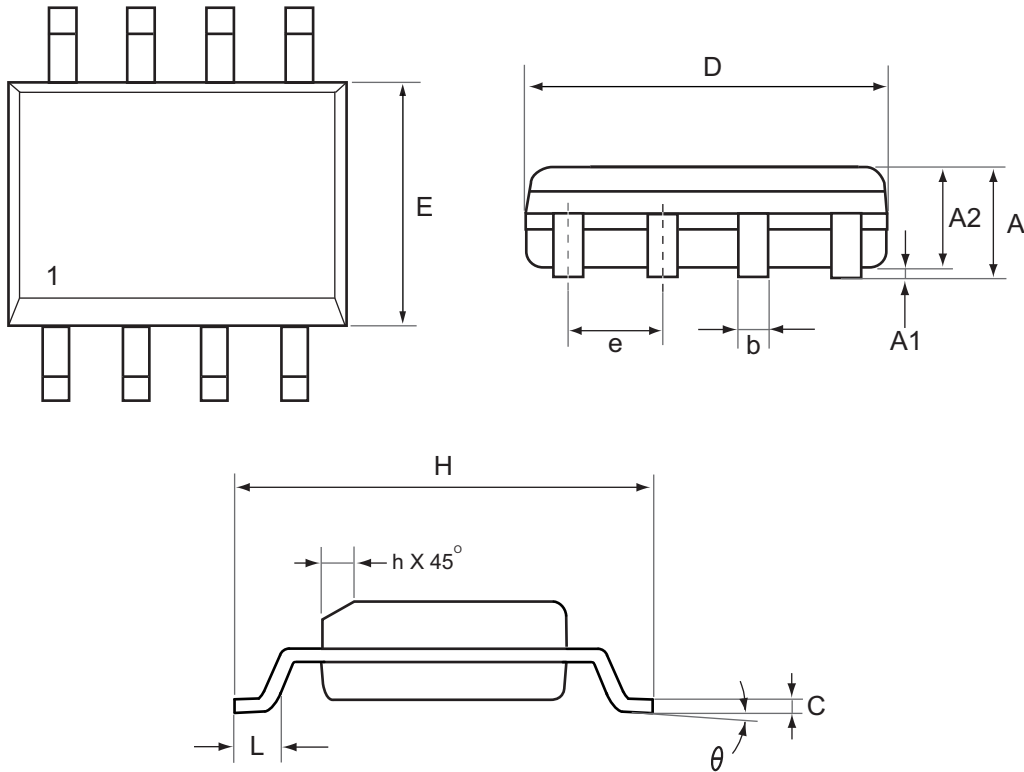

SYMBOLS	MILLIMETERS		INCHES	
	MIN	MAX	MIN	MAX
A	1.35	1.75	0.053	0.069
A1	0.10	0.25	0.004	0.010
A2	1.25	1.63	0.049	0.064
b	0.31	0.51	0.012	0.020
C	0.17	0.25	0.007	0.010
D	4.80	5.00	0.189	0.197
E	3.70	4.00	0.146	0.157
e	1.27 REF.		0.050 BSC	
H	5.80	6.20	0.228	0.244
L	0.40	1.27	0.016	0.050
theta	0°	8°	0°	8°
h	0.25	0.50	0.010	0.020

SO-8 Tape and Reel Data

SO-8 Carrier Tape

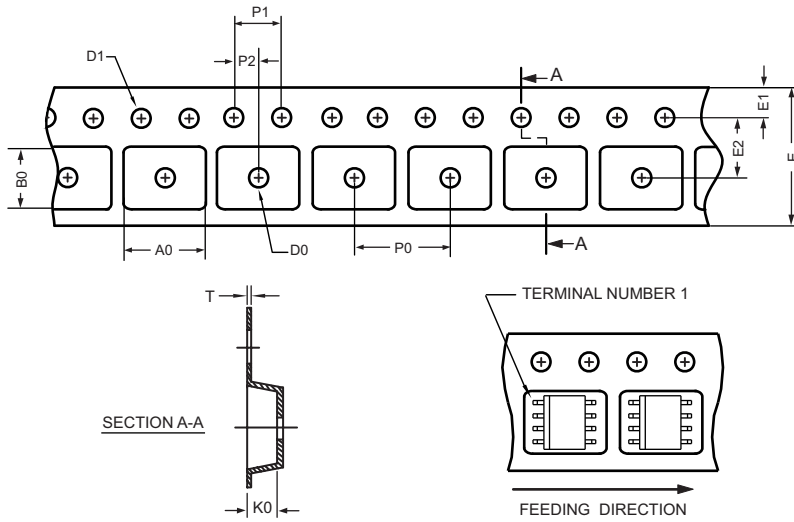

unit:mm

PACKAGE	A0	B0	K0	D0	D1	E	E1	E2	P0	P1	P2	T
SOP 8N 150mil	6.50 ±0.15	5.25 ±0.10	2.10 ±0.10	φ 1.5 (MIN)	φ 1.55 ±0.10	12.0 +0.3 - 0.1	1.75 ±0.10	5.5 ±0.10	8.0 ±0.10	4.0 ±0.10	2.0 ±0.10	0.30 ±0.013

SO-8 Reel

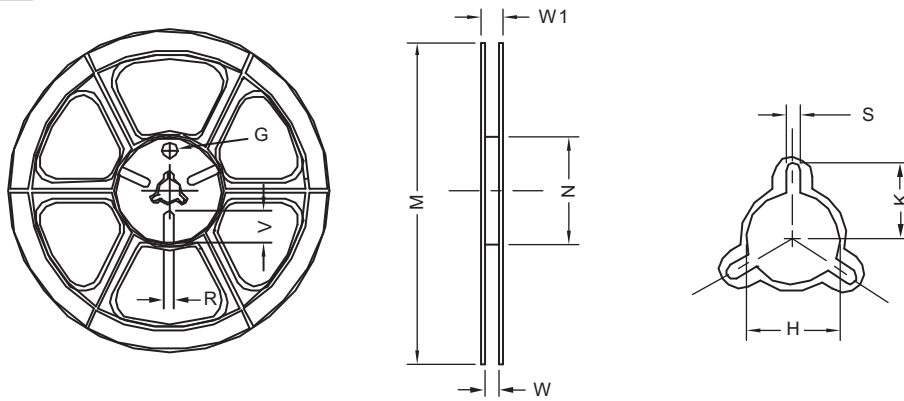

UNIT:mm

TAPE SIZE	REEL SIZE	M	N	W	W1	H	K	S	G	R	V
12 mm	φ 330	330 ± 1	62 ±1.5	12.4 + 0.2	16.8 - 0.4	φ 12.75 + 0.15	---	2.0 ±0.15	---	---	---