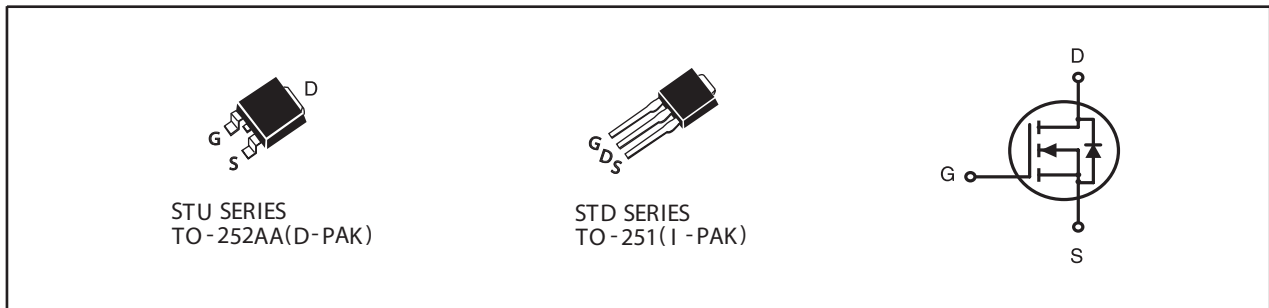

**N-Channel Logic Level Enhancement Mode Field Effect Transistor****PRODUCT SUMMARY**

V _{DSS}	I _D	R _{DS(ON)} (mΩ) Typ
100V	40A	18 @ V _{GS} =10V

FEATURES

- Super high dense cell design for low R_{DS(ON)}.
- Rugged and reliable.
- TO-252 and TO-251 Package.

**ABSOLUTE MAXIMUM RATINGS (T_C=25°C unless otherwise noted)**

Symbol	Parameter	Limit	Units
V _{DS}	Drain-Source Voltage	100	V
V _{GS}	Gate-Source Voltage	±20	V
I _D	Drain Current-Continuous	T _C =25°C	40
		T _C =70°C	33.5
I _{DM}	-Pulsed ^a	117	A
P _D	Maximum Power Dissipation	T _C =25°C	75
		T _C =70°C	52.5
T _J , T _{STG}	Operating Junction and Storage Temperature Range	-55 to 175	°C

THERMAL CHARACTERISTICS

R _{θJC}	Thermal Resistance, Junction-to-Case	2	°C/W
R _{θJA}	Thermal Resistance, Junction-to-Ambient	50	°C/W

STU/D40N01

Ver 1.0

ELECTRICAL CHARACTERISTICS (T_C=25°C unless otherwise noted)

Symbol	Parameter	Conditions	Min	Typ	Max	Units
OFF CHARACTERISTICS						
BV _{DSS}	Drain-Source Breakdown Voltage	V _{GS} =0V , I _D =250uA	100			V
I _{DSS}	Zero Gate Voltage Drain Current	V _{DS} =80V , V _{GS} =0V			1	uA
I _{GSS}	Gate-Body Leakage Current	V _{GS} = ±20V , V _{BS} =0V			±100	nA
ON CHARACTERISTICS						
V _{GS(th)}	Gate Threshold Voltage	V _{DS} =V _{GS} , I _D =250uA	2	2.8	4	V
R _{DS(ON)}	Drain-Source On-State Resistance	V _{GS} =10V , I _D =20A		18	24	m ohm
g _{FS}	Forward Transconductance	V _{DS} =10V , I _D =20A		36		S
DYNAMIC CHARACTERISTICS^b						
C _{ISS}	Input Capacitance	V _{DS} =25V, V _{GS} =0V f=1.0MHz		2140		pF
C _{OSS}	Output Capacitance			227		pF
C _{RSS}	Reverse Transfer Capacitance			122		pF
SWITCHING CHARACTERISTICS^b						
t _{D(ON)}	Turn-On Delay Time	V _{DD} =50V I _D =1A V _{GS} =10V R _{GEN} = 6 ohm		52		ns
t _r	Rise Time			55		ns
t _{D(OFF)}	Turn-Off Delay Time			64		ns
t _f	Fall Time			20		ns
Q _g	Total Gate Charge	V _{DS} =50V, I _D =20A, V _{GS} =10V		25		nC
Q _{gs}	Gate-Source Charge	V _{DS} =50V, I _D =20A, V _{GS} =10V		4.6		nC
Q _{gd}	Gate-Drain Charge			9.4		nC
DRAIN-SOURCE DIODE CHARACTERISTICS AND MAXIMUM RATINGS						
V _{SD}	Diode Forward Voltage	V _{GS} =0V, I _S =5A		0.75	1.3	V
Notes						
a.Pulse Test:Pulse Width ≤ 300us, Duty Cycle ≤ 2%.						
b.Guaranteed by design, not subject to production testing.						

Jul,05,2012

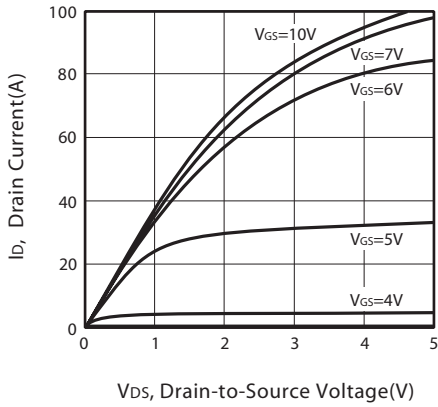

Figure 1. Output Characteristics

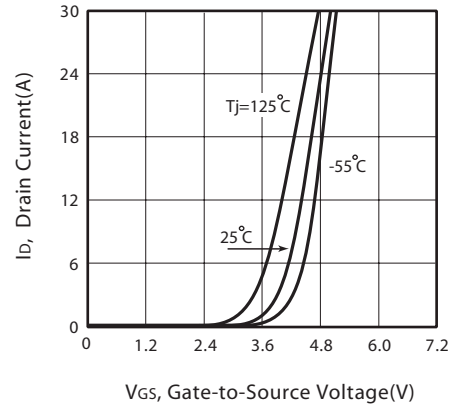

Figure 2. Transfer Characteristics

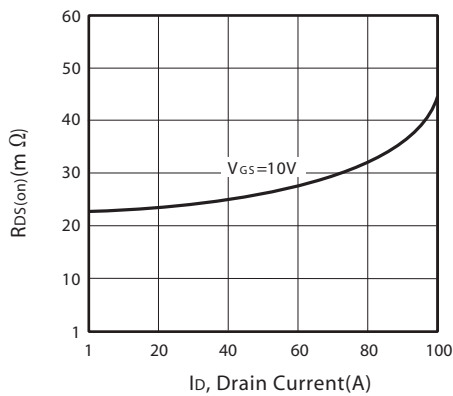

Figure 3. On-Resistance vs. Drain Current and Gate Voltage

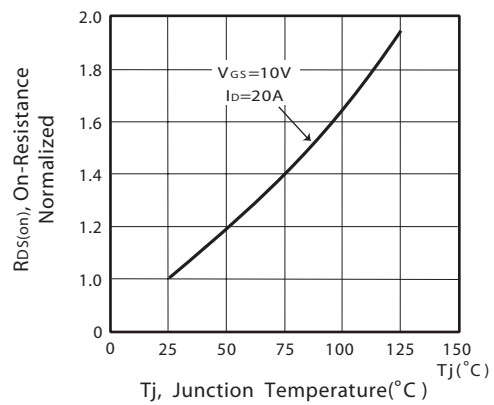

Figure 4. On-Resistance Variation with Drain Current and Temperature

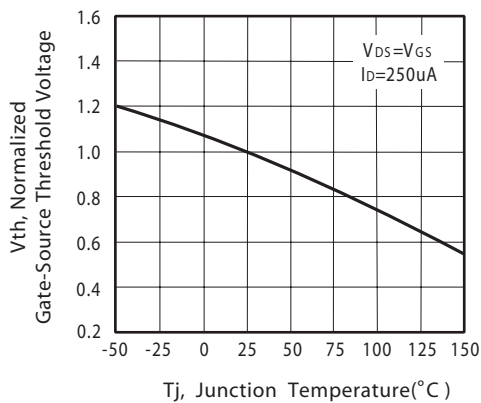

Figure 5. Gate Threshold Variation with Temperature

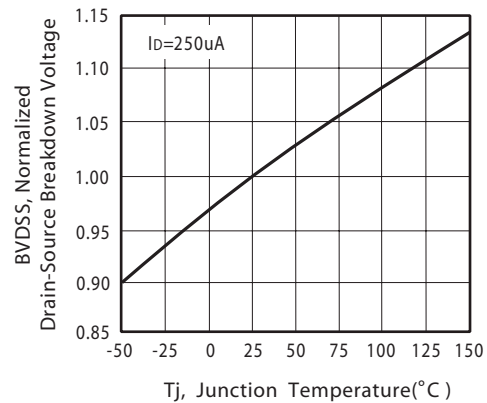

Figure 6. Breakdown Voltage Variation with Temperature

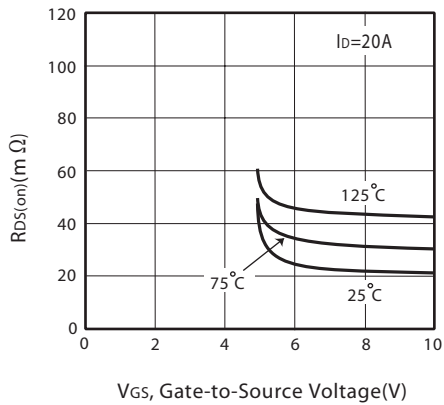

Figure 7. On-Resistance vs. Gate-Source Voltage

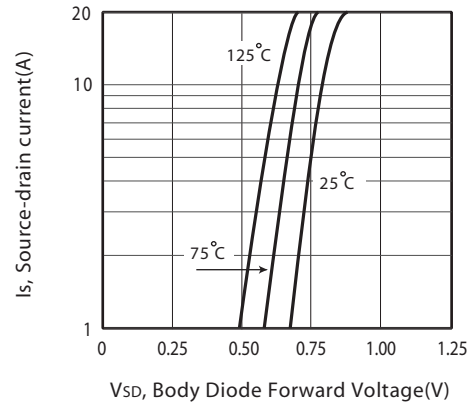

Figure 8. Body Diode Forward Voltage Variation with Source Current

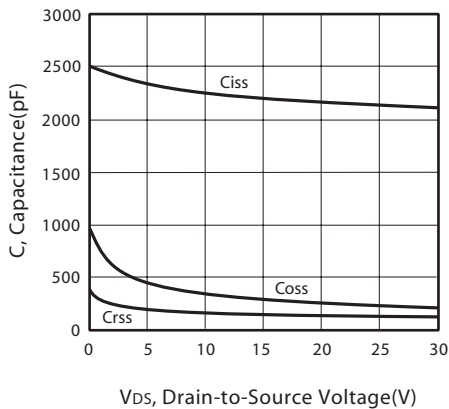

Figure 9. Capacitance

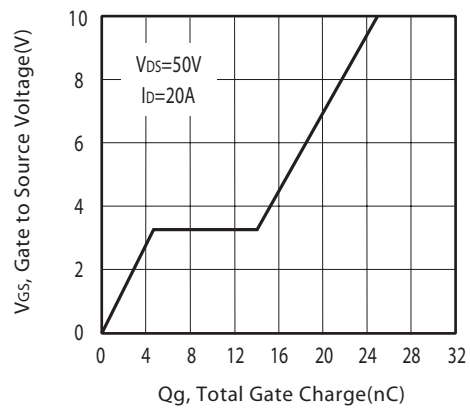

Figure 10. Gate Charge

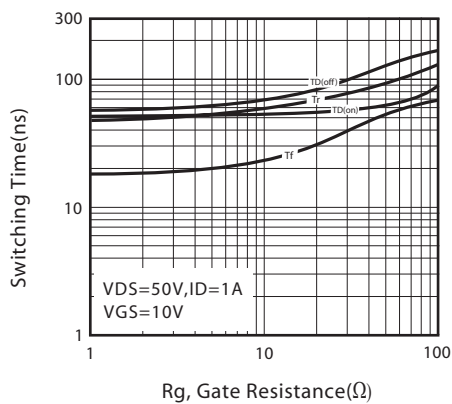

Figure 11. switching characteristics

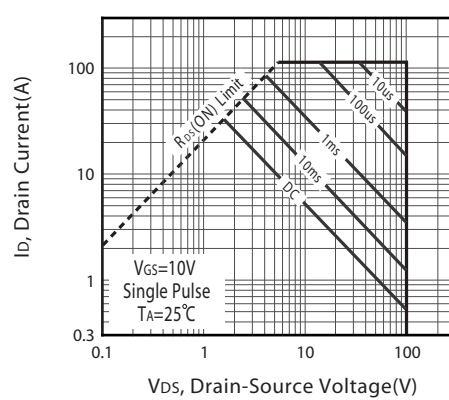
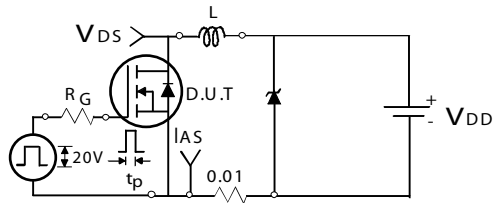
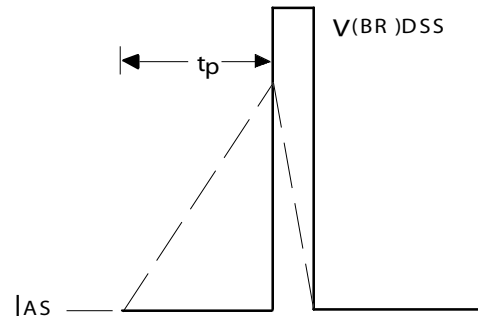

Figure 12. Maximum Safe Operating Area



Unclamped Inductive Test Circuit

Figure 13a.



Unclamped Inductive Waveforms

Figure 13b.

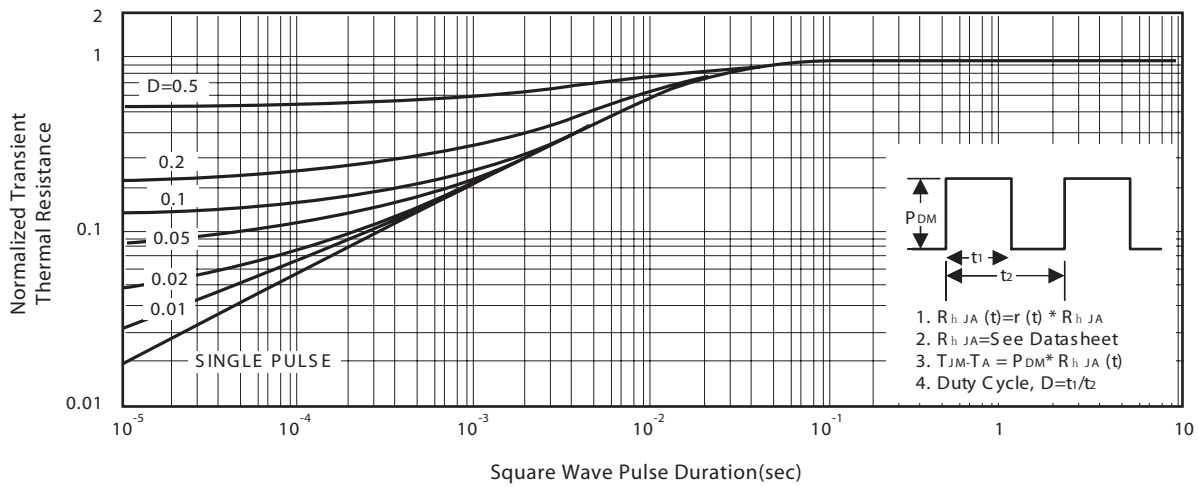
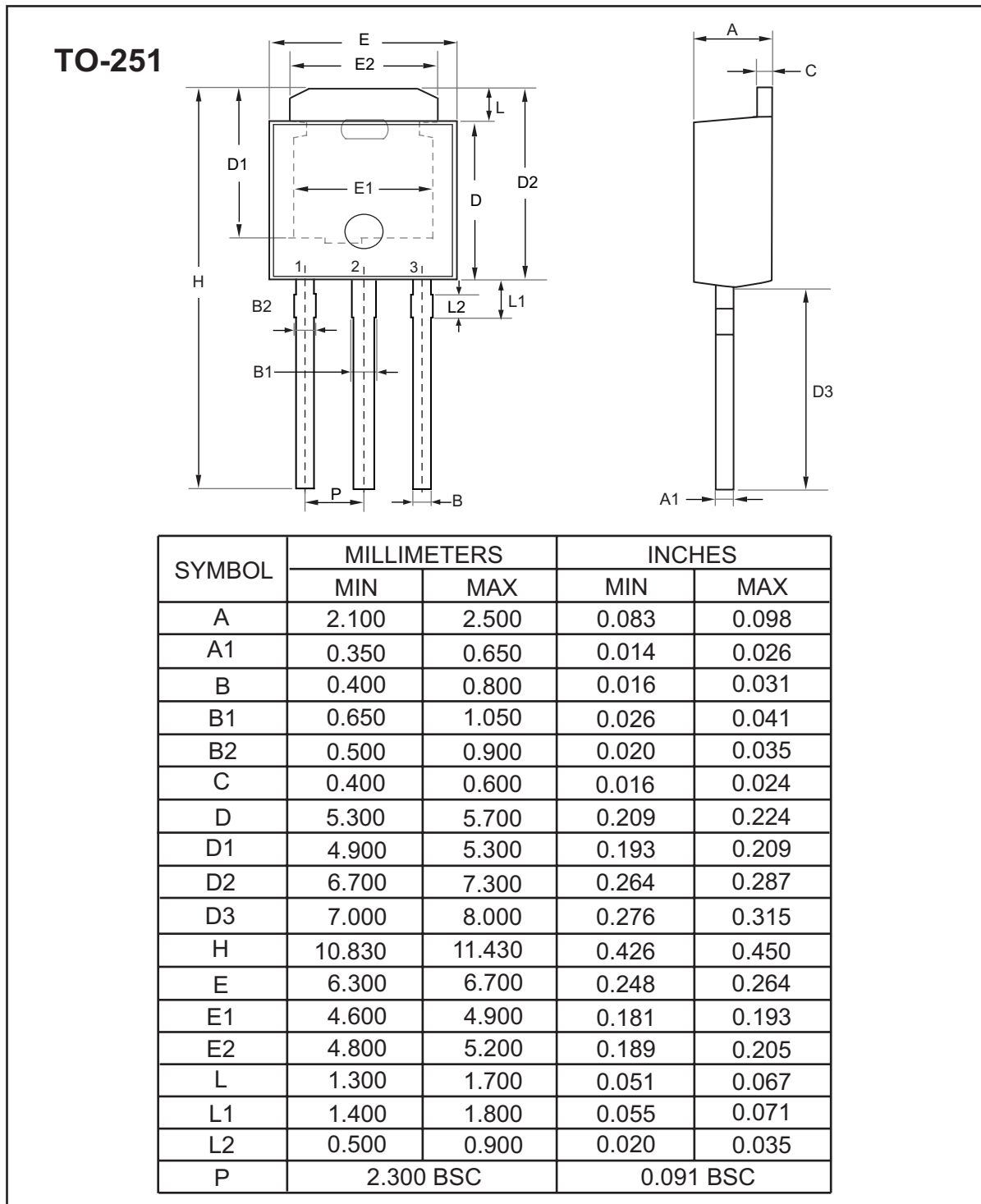

Figure 14. Normalized Thermal Transient Impedance Curve

PACKAGE OUTLINE DIMENSIONS



STU/D40N01

Ver 1.0

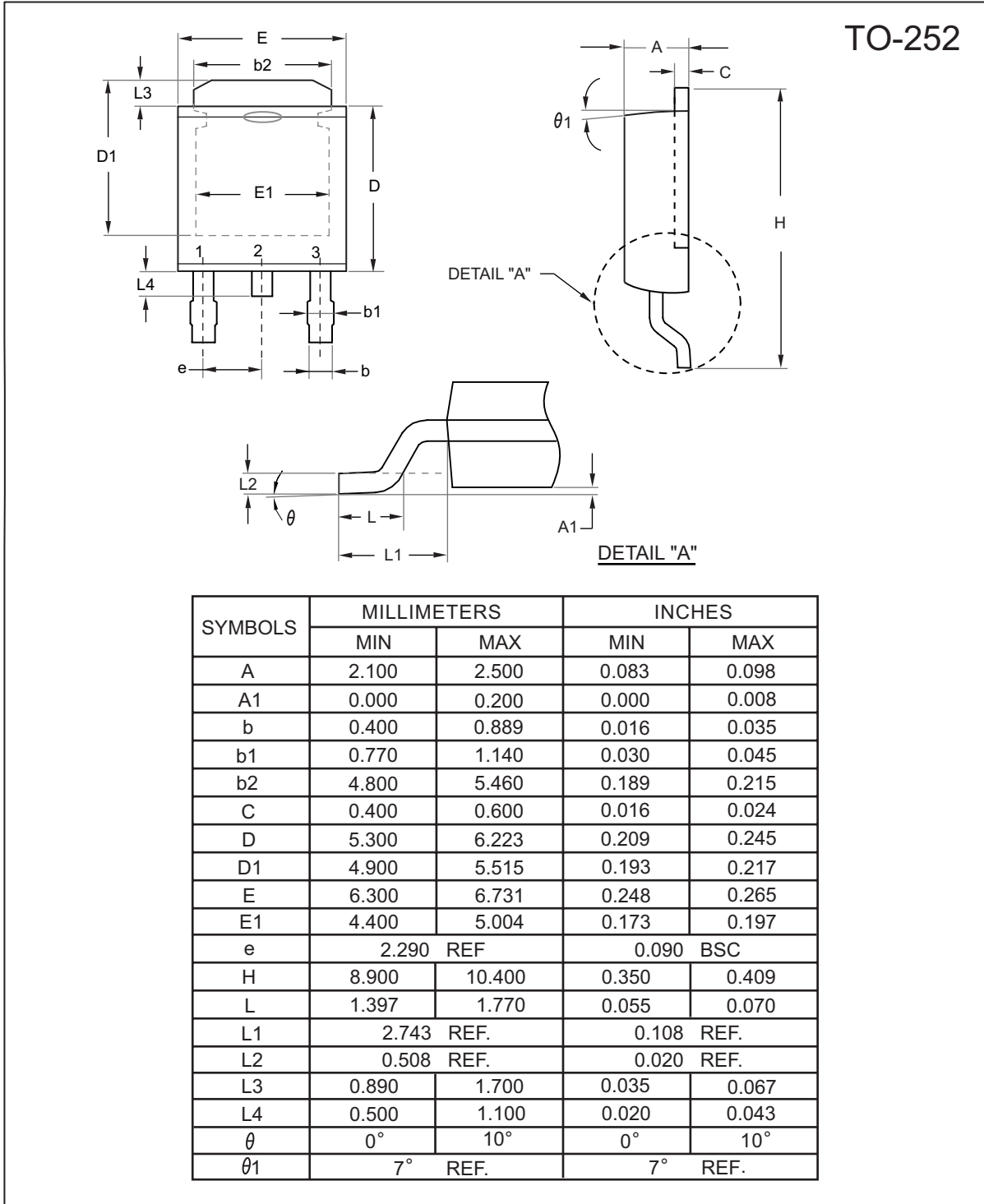

Jul,05,2012

TO-251 Tube/TO-252 Tape and Reel Data

TO-251 Tube



TO-252 Carrier Tape



UNIT:mm

PACKAGE	A0	B0	K0	D0	D1	E	E1	E2	P0	P1	P2	T
TO-252 (16 mm)	6.96 ±0.1	10.49 ±0.1	2.79 ±0.1	φ 2	φ 1.5 + 0.1 - 0	16.0 ±0.3	1.75 ±0.1	7.5 ±0.15	8.0 ±0.1	4.0 ±0.1	2.0 ±0.15	0.3 ±0.05

TO-252 Reel

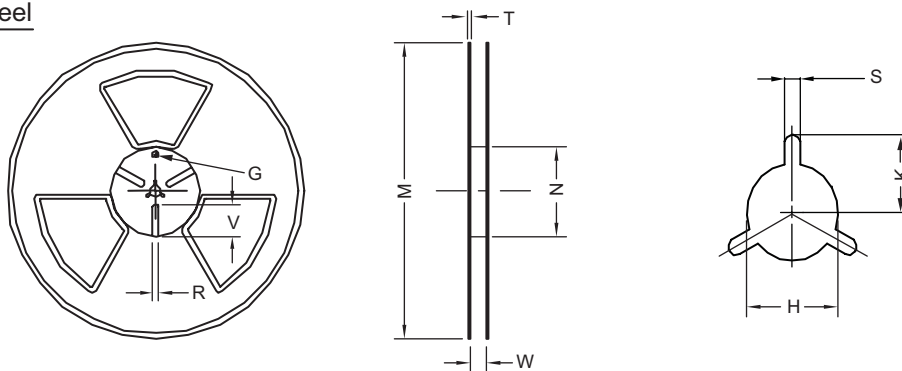

UNIT:mm

TAPE SIZE	REEL SIZE	M	N	W	T	H	K	S	G	R	V
16 mm	φ 330	φ 330 ± 0.5	φ 97 ± 1.0	17.0 + 1.5 - 0	2.2	φ 13.0 + 0.5 - 0.2	10.6	2.0 ±0.5	---	---	---